

Protection Device

TVS (Transient Voltage Suppressor)

ESD311-U1-02N

Uni-directional, 15 V, 210 pF, 0603, RoHS and Halogen Free compliant

ESD311-U1-02N

Data Sheet

Revision 1.0, 2014-05-28
Final

Power Management & Multimarket

Edition 2014-05-28

Published by

Infineon Technologies AG

81726 Munich, Germany

© 2014 Infineon Technologies AG

All Rights Reserved.

Information

For further information on technology, delivery terms and conditions and prices, please contact the nearest Infineon Technologies Office (www.infineon.com)

Warnings

Due to technical requirements, components may contain dangerous substances. For information on the types in question, please contact the nearest Infineon Technologies Office.

Infineon Technologies components may be used in life-support devices or systems only with the express written approval of Infineon Technologies, if a failure of such components can reasonably be expected to cause the failure of that life-support device or system or to affect the safety or effectiveness of that device or system. Life support devices or systems are intended to be implanted in the human body or to support and/or maintain and sustain and/or protect human life. If they fail, it is reasonable to assume that the health of the user or other persons may be endangered.

1 Product Overview

1.1 Features

- ESD / Transient / Surge protection according to:
 - IEC61000-4-2 (ESD): ± 30 kV (air / contact discharge)
 - IEC61000-4-4 (EFT): ± 4 kV / ± 80 A (5/50 ns)
 - IEC61000-4-5 (surge): ± 28 A (8/20 μ s)
- Uni-directional working voltage up to $V_{RWM} = 15$ V
- Low capacitance: $C_L = 210$ pF (typical)
- Low clamping voltage $V_{CL} = 29$ V (typical) at $I_{PP} = 28$ A
- Low reverse current. $I_R < 1$ nA (typical)
- Small and flat-profile SMD plastic package: 1.6 mm x 0.8 mm x 0.375 mm.
- Pb-free (RoHS compliant) and halogen free package



1.2 Application Examples

- Surge protection of USB V_{BUS} lines in mobile devices

1.3 Product Description

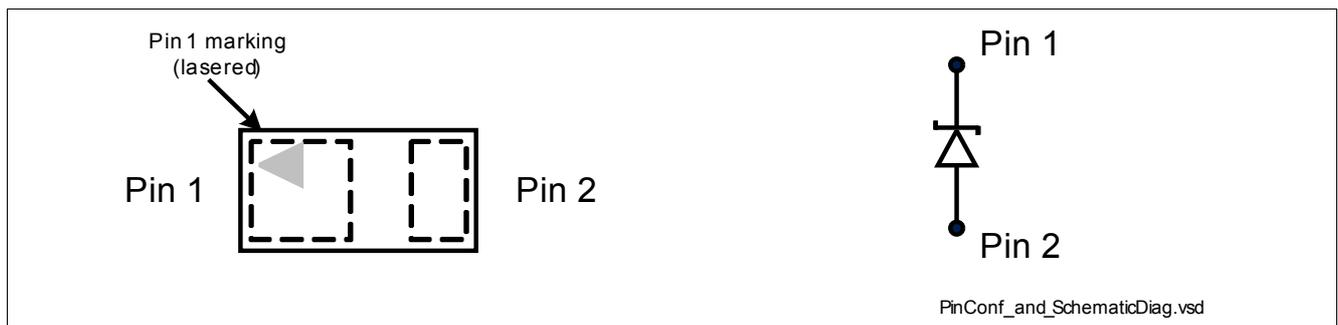

Figure 1-1 Pin Configuration and Schematic Diagram (in mm)

Table 1-1 Part Information

Type	Package	Configuration	Marking code
ESD311-U1-02N	TSNP-2-2	uni-directional	A

2 Maximum Ratings

Table 2-1 Maximum Ratings at $T_A = 25\text{ }^\circ\text{C}$, unless otherwise specified

Parameter	Symbol	Values	Unit
ESD air / contact discharge ¹⁾	V_{ESD}	± 30	kV
Peak pulse power ²⁾	P_{PK}	800	W
Peak pulse current ²⁾	I_{PP}	28	A
Operating temperature range	T_{OP}	-40 to 125	$^\circ\text{C}$
Storage temperature	T_{stg}	-65 to 150	$^\circ\text{C}$

1) V_{ESD} according to IEC61000-4-2

2) Non-repetitive current pulse 8/20 μs exponential decay waveform according to IEC61000-4-5

Attention: Stresses above the max. values listed here may cause permanent damage to the device. Exposure to absolute maximum rating conditions for extended periods may affect device reliability. Maximum ratings are absolute ratings; exceeding only one of these values may cause irreversible damage to the integrated circuit.

3 Electrical Characteristics

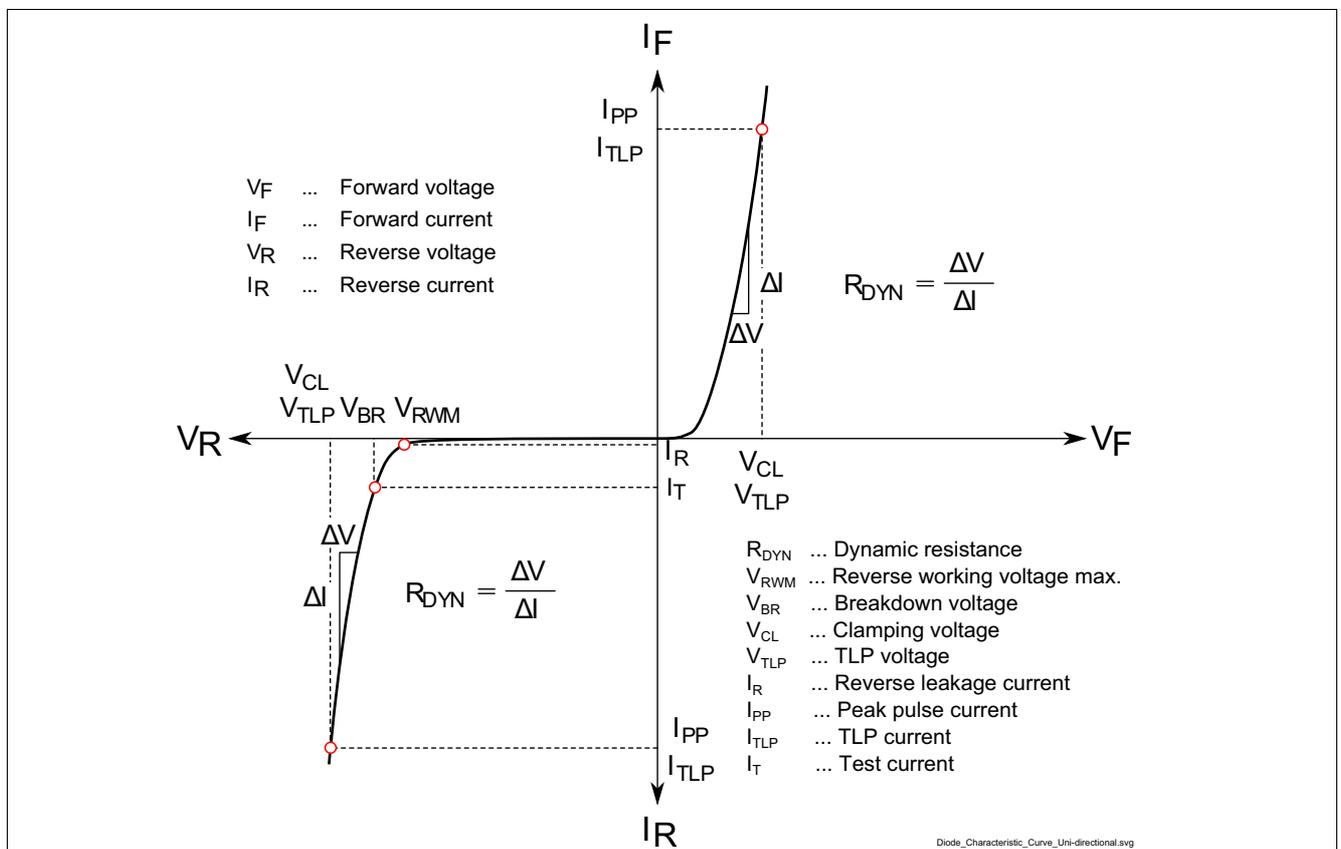

Figure 3-1 Definitions of electrical characteristics

Electrical Characteristics

Table 3-1 DC Characteristics at $T_A = 25\text{ }^\circ\text{C}$, unless otherwise specified

Parameter	Symbol	Values			Unit	Note / Test Condition
		Min.	Typ.	Max.		
Reverse working voltage	V_{RWM}	–	–	15	V	
Breakdown voltage	V_{BR}	16	17	–	V	$I_T = 1\text{ mA}$
Reverse current	I_R	–	<1	100	nA	$V_R = 15\text{ V}$

Table 3-2 AC Characteristics at $T_A = 25\text{ }^\circ\text{C}$, unless otherwise specified

Parameter	Symbol	Values			Unit	Note / Test Condition
		Min.	Typ.	Max.		
Line capacitance	C_L	–	210	290	pF	$V_R = 0\text{ V}, f = 1\text{ MHz}$

Table 3-3 ESD and Surge Characteristics at $T_A = 25\text{ }^\circ\text{C}$, unless otherwise specified

Parameter	Symbol	Values			Unit	Note / Test Condition
		Min.	Typ.	Max.		
Clamping voltage ¹⁾	V_{CL}	–	22	26.5	V	$I_{TLP} = 16\text{ A}, t_p = 100\text{ ns}$
		–	23	28		$I_{TLP} = 30\text{ A}, t_p = 100\text{ ns}$
Clamping voltage ²⁾		–	21	25.5		$I_{PP} = 1\text{ A}, t_p = 8/20\text{ }\mu\text{s}$
		–	29	35		$I_{PP} = 28\text{ A}, t_p = 8/20\text{ }\mu\text{s}$
Dynamic resistance ¹⁾	R_{DYN}	–	0.07	–	Ω	$t_p = 100\text{ ns}$

1) Please refer to Application Note AN210[1]. TLP parameter: $Z_0 = 50\text{ }\Omega$, $t_p = 100\text{ ns}$, $t_r = 600\text{ ps}$.

2) Non-repetitive current pulse 8/20 μs exponential decay waveform according to IEC61000-4-5

4 Typical Characteristics Diagrams

Typical characteristics diagrams at $T_A = 25^\circ\text{C}$, unless otherwise specified

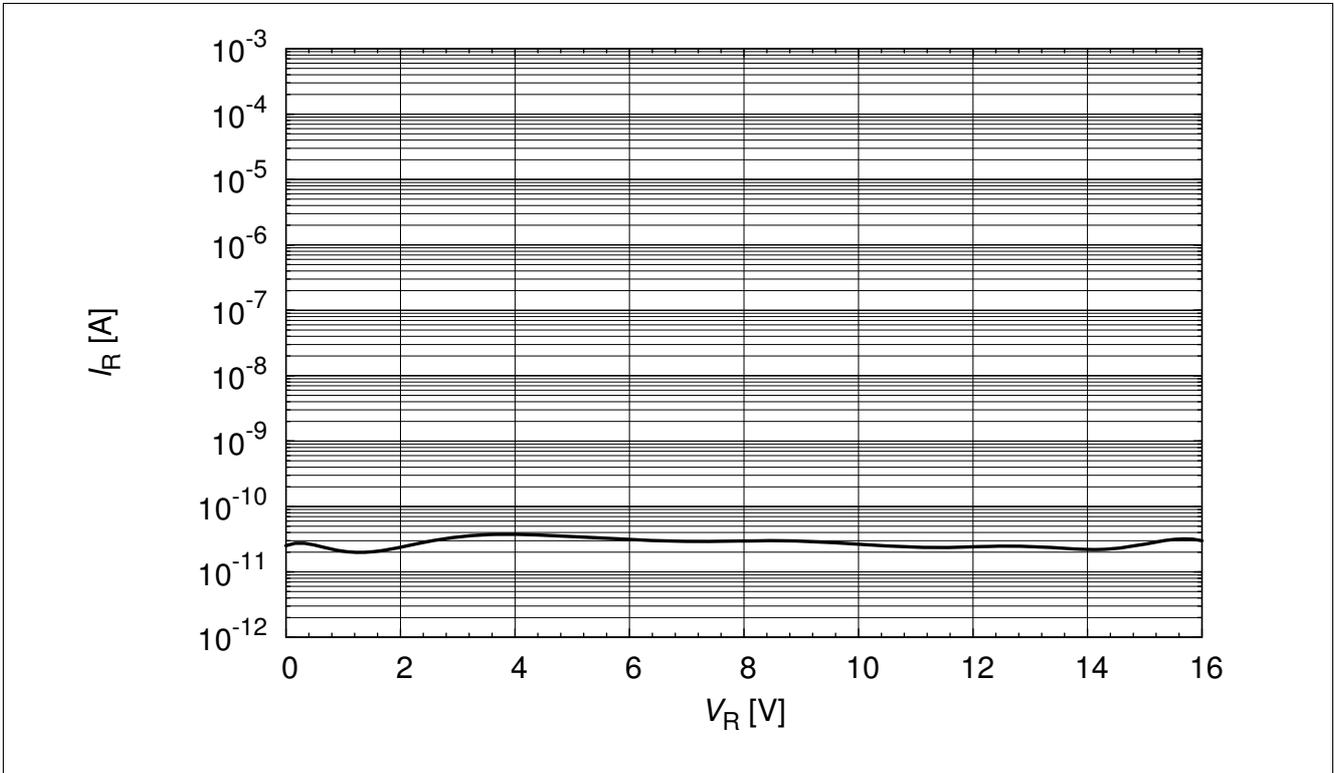

Figure 4-1 Reverse leakage current: $I_R = f(V_R)$

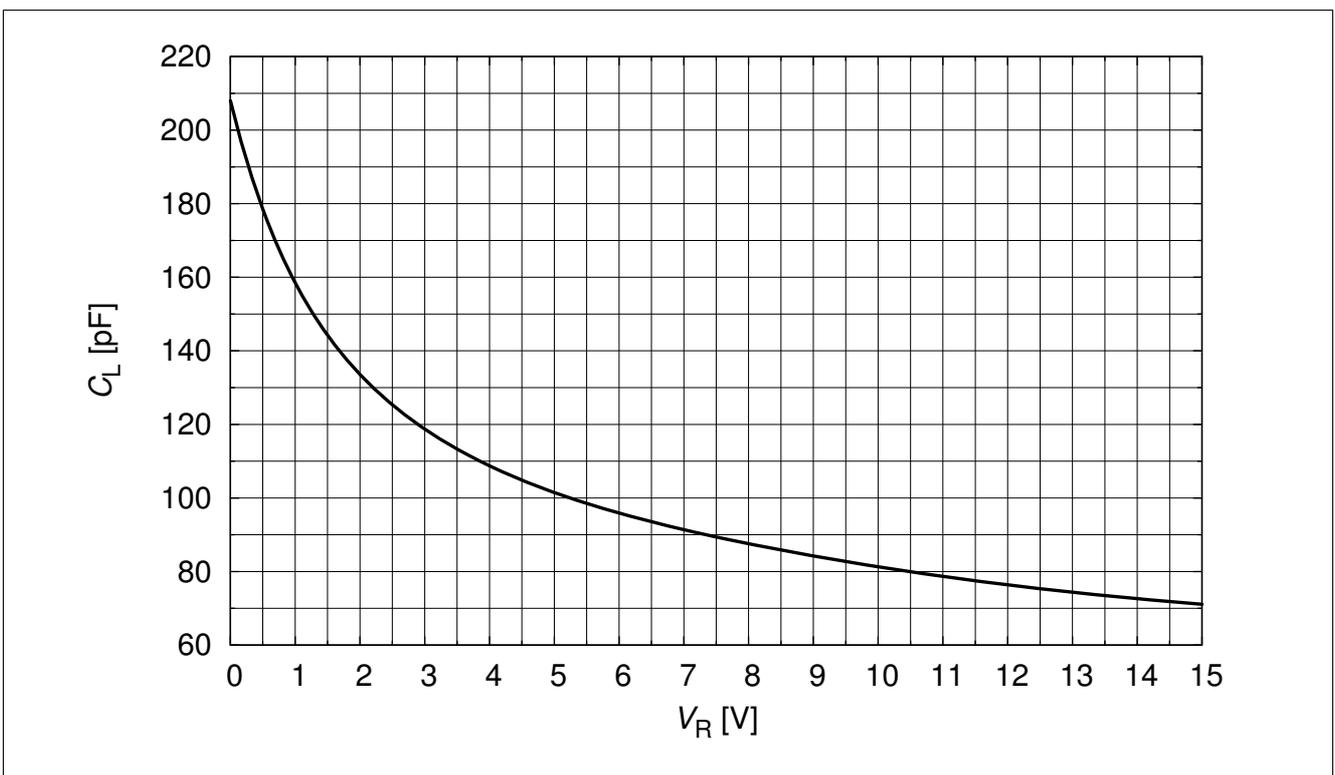

Figure 4-2 Line capacitance: $C_L = f(V_R)$

Typical Characteristics Diagrams

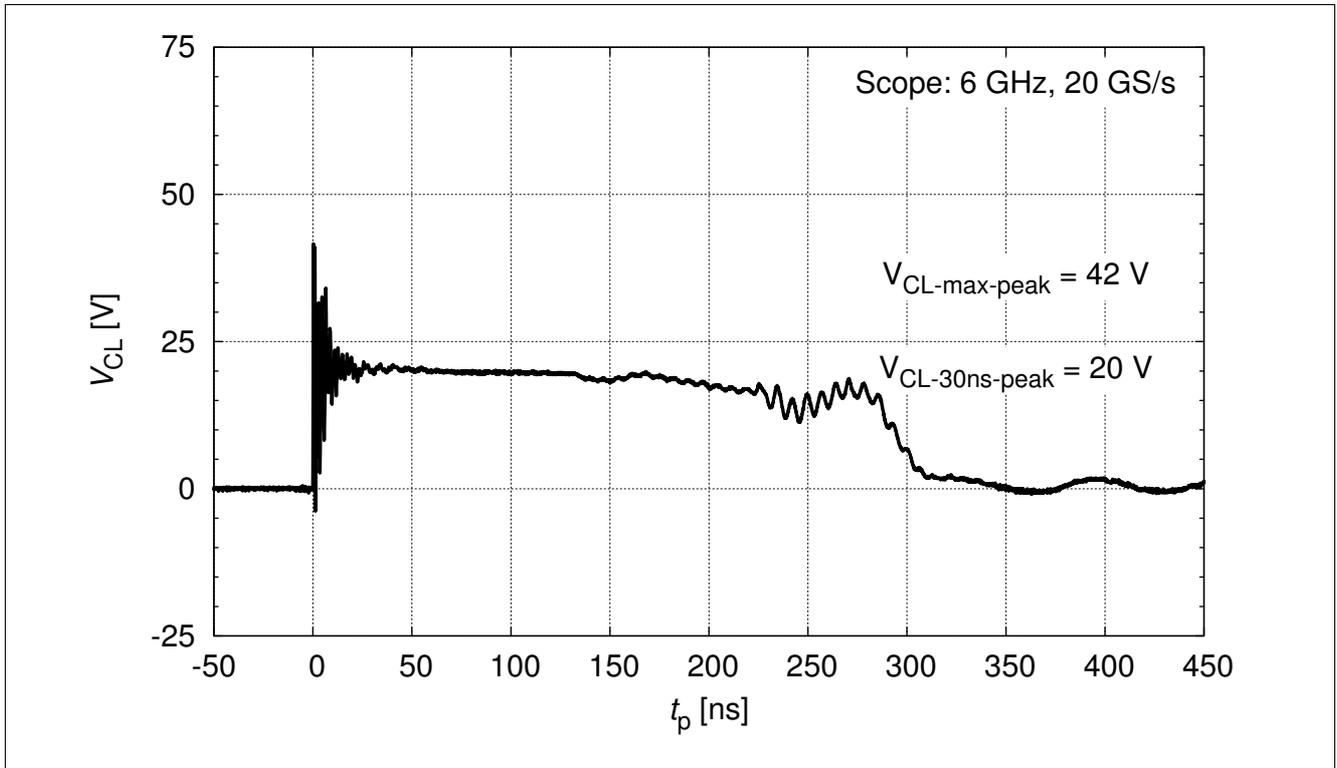

Figure 4-3 Clamping voltage (ESD): $V_{CL} = f(t)$, 8 kV positive pulse from pin 1 to pin 2

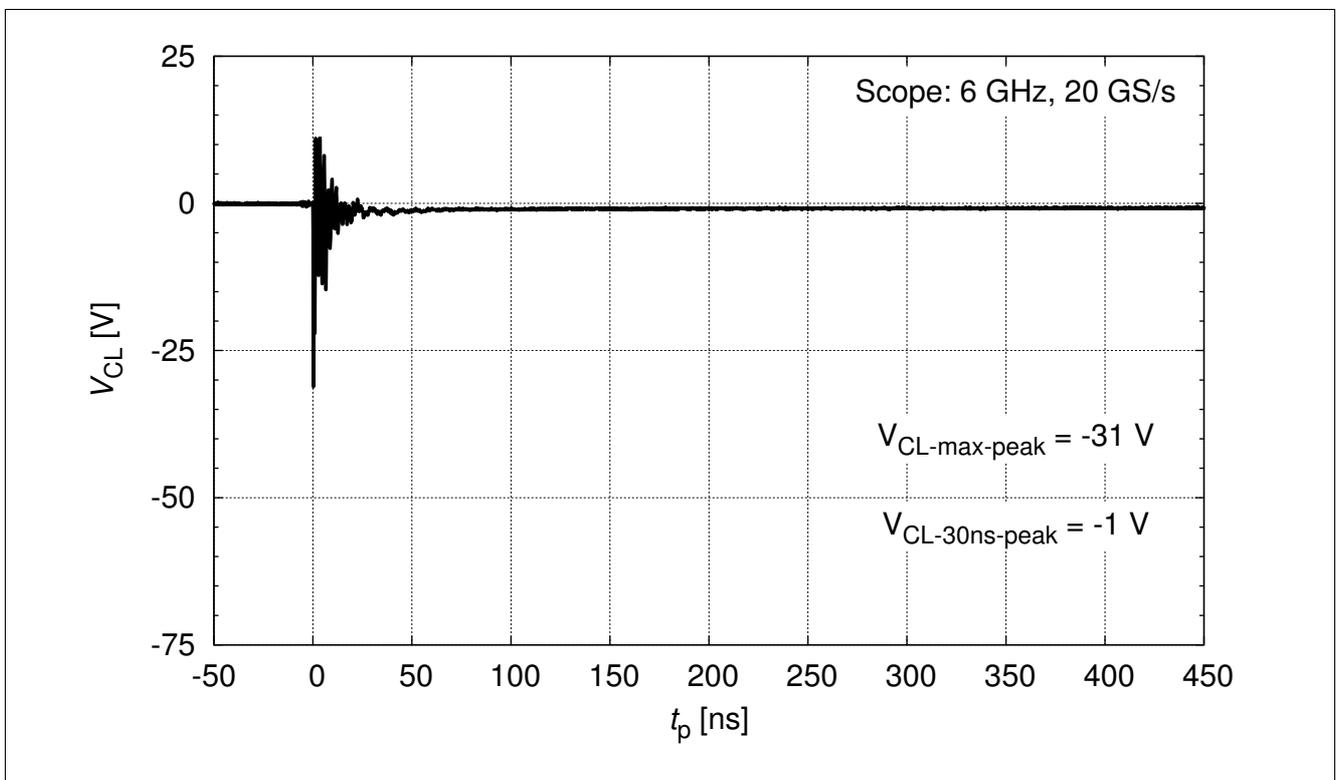

Figure 4-4 Clamping voltage (ESD) $V_{CL} = f(t)$, 8 kV negative pulse from pin 1 to pin 2

Typical Characteristics Diagrams

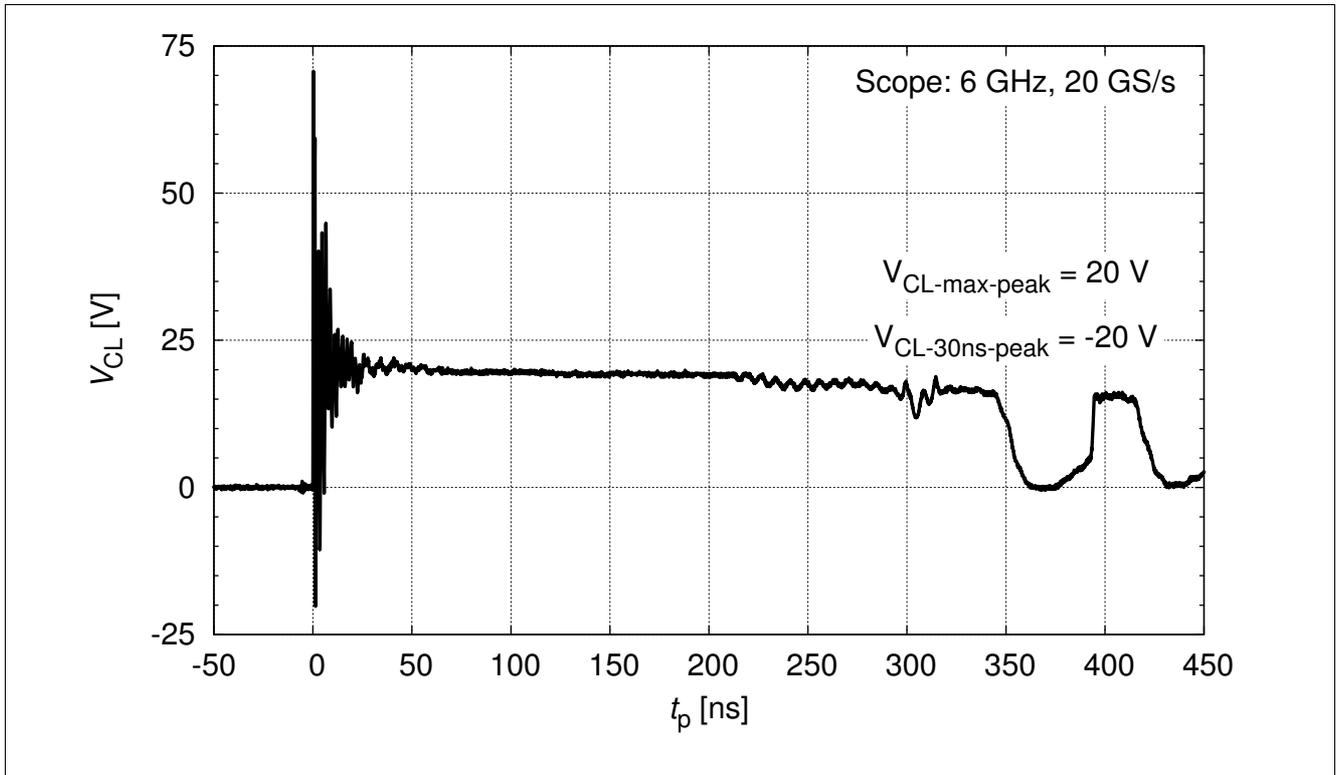

Figure 4-5 Clamping voltage (ESD) $V_{CL} = f(t)$, 15 kV positive pulse from pin 1 to pin 2

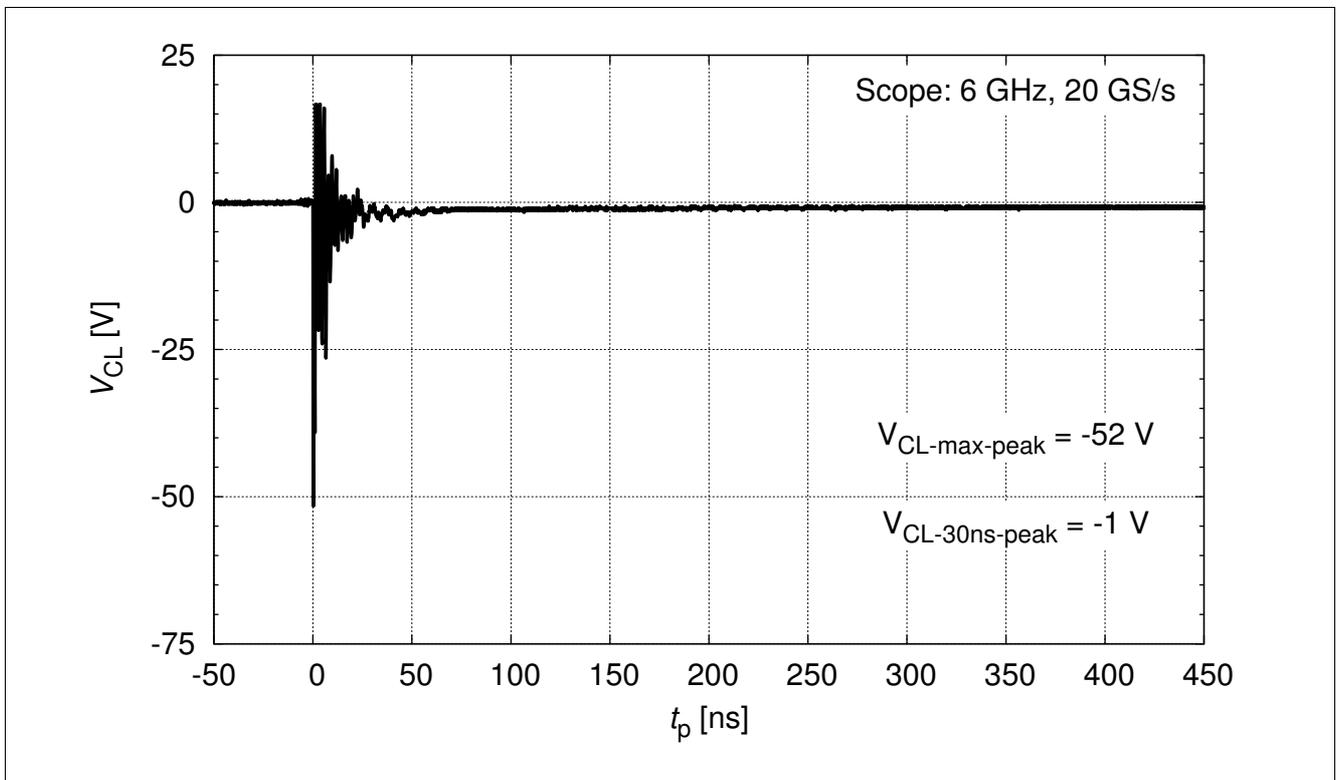

Figure 4-6 Clamping voltage (ESD) $V_{CL} = f(t)$, 15 kV negative pulse from pin 1 to pin 2

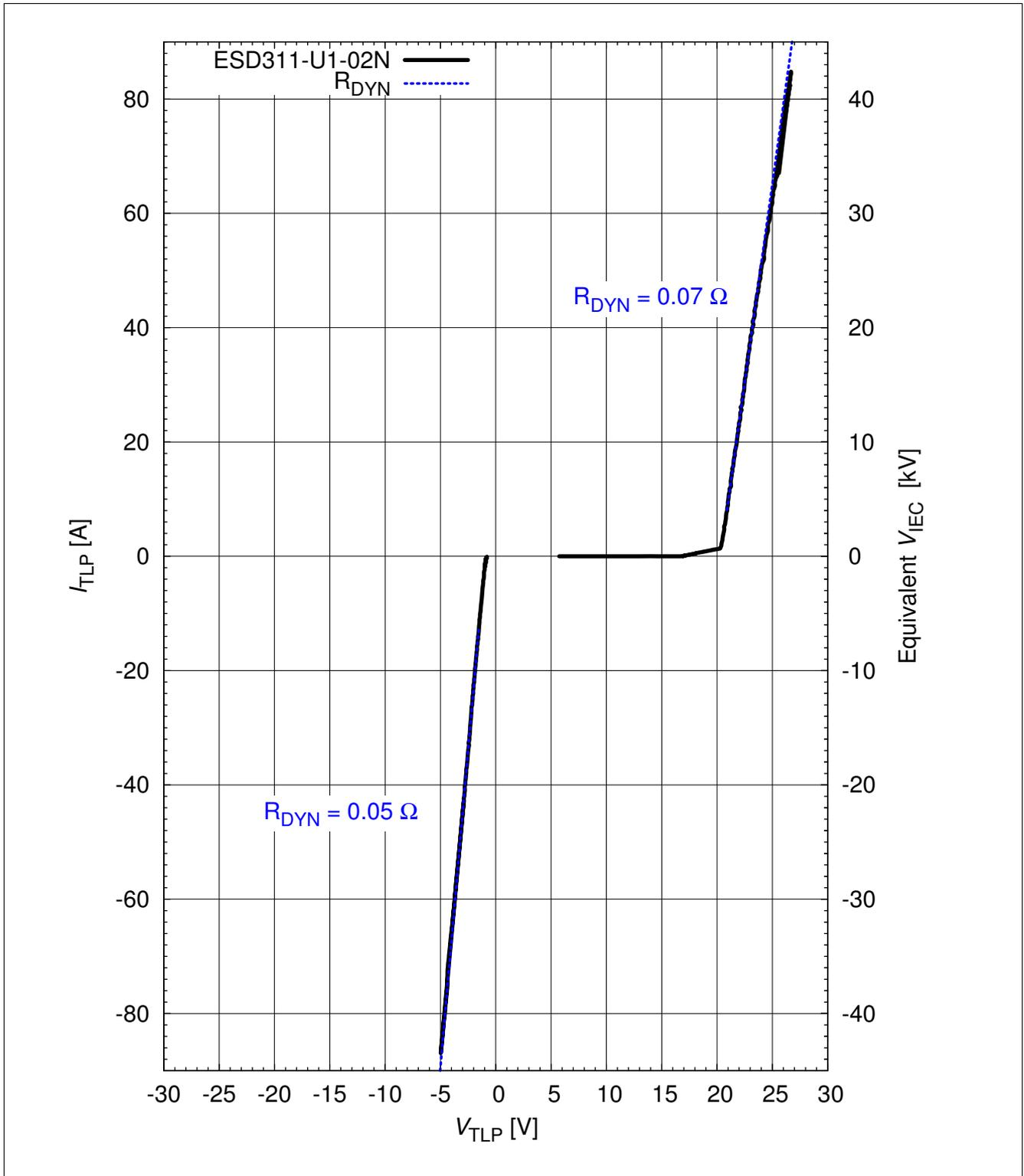

Figure 4-7 Clamping voltage (TLP): $I_{TLP} = f(V_{TLP})$ [1], pin 1 to pin 2

Typical Characteristics Diagrams

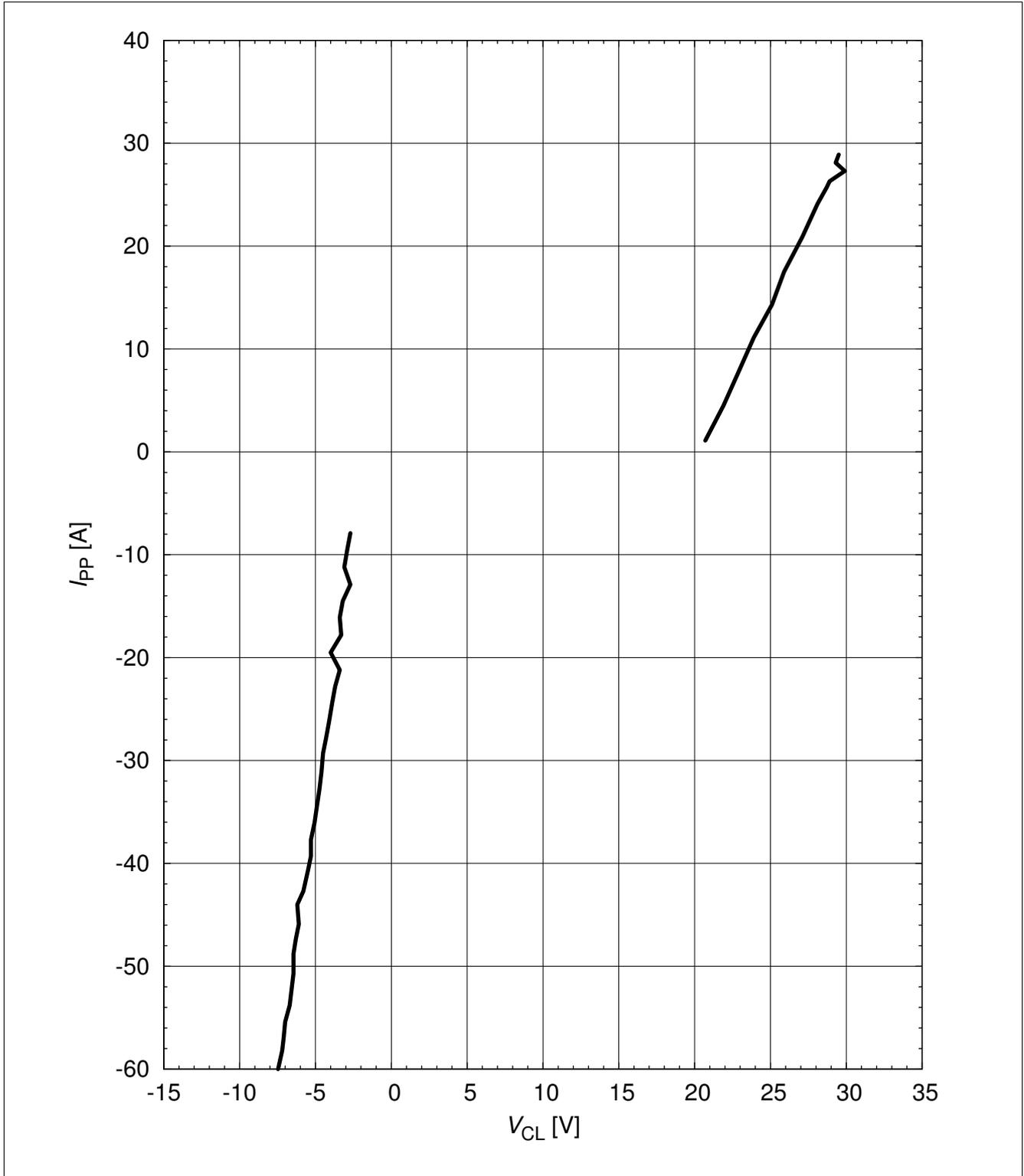

Figure 4-8 Pulse current (Surge): $I_{PP} = f(V_{CL})$ [1], pin 1 to pin 2

5 Package Information

5.1 TSNP-2-2

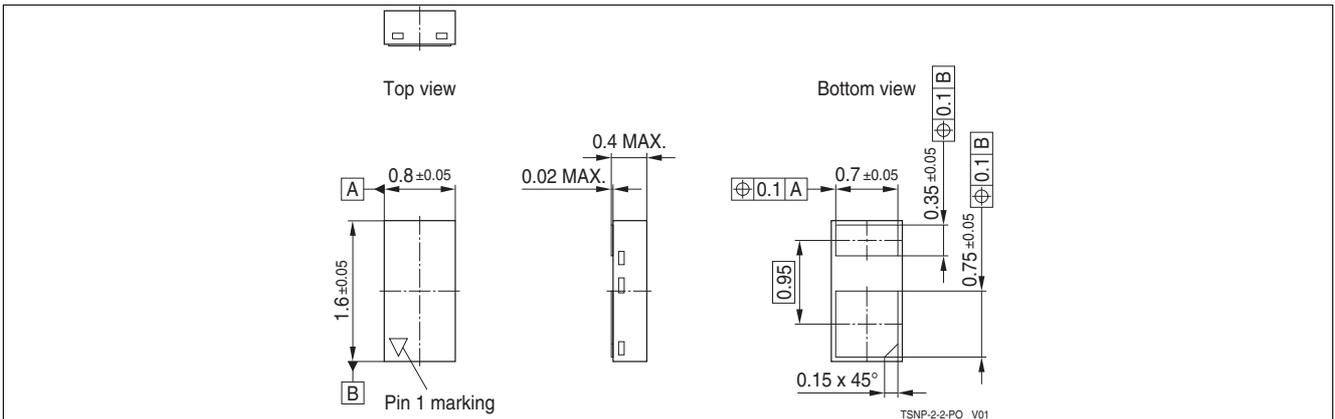

Figure 5-1 TSNP-2-2: Package outline

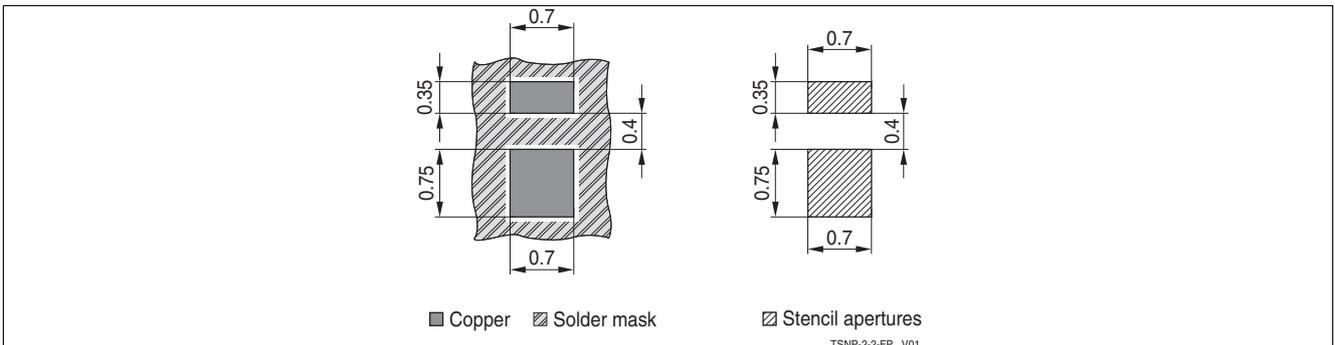

Figure 5-2 TSNP-2-2: Footprint

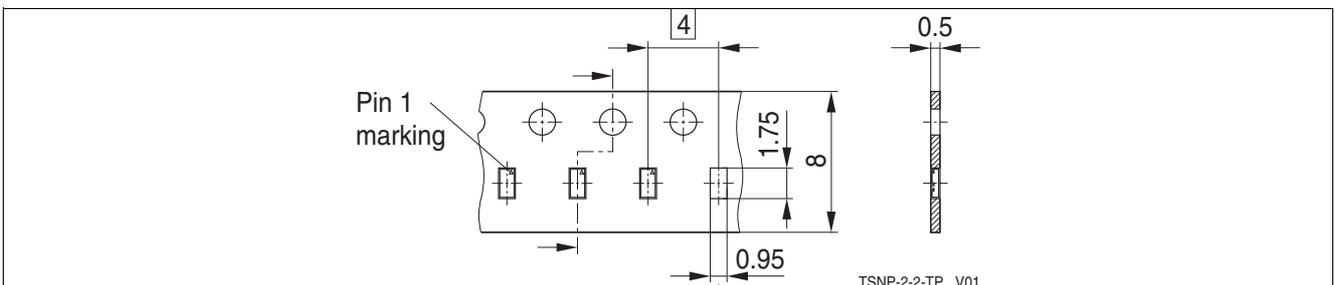

Figure 5-3 TSNP-2-2: Packing

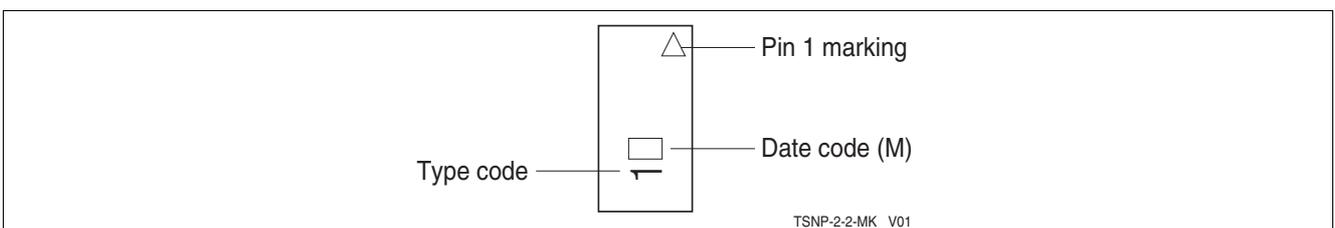

Figure 5-4 TSNP-2-2: Marking example, Type code see: [Table 1-1 "Part Information" on Page 3](#)

Revision History: Rev. 0.9.1, 2014-05-20

Page or Item	Subjects (major changes since previous revision)
Revision 1.0, 2014-05-28	
All	Status change to final

Trademarks of Infineon Technologies AG

AURIX™, BlueMoon™, C166™, CanPAK™, CIPOS™, CIPURSE™, COMNEON™, EconoPACK™, CoolMOS™, CoolSET™, CORECONTROL™, CROSSAVE™, DAVE™, EasyPIM™, EconoBRIDGE™, EconoDUAL™, EconoPIM™, EiceDRIVER™, eupec™, FCOS™, HITFET™, HybridPACK™, I²RF™, ISOFACE™, IsoPACK™, MIPAQ™, ModSTACK™, my-d™, NovalithIC™, OmniTune™, OptiMOS™, ORIGA™, PRIMARION™, PrimePACK™, PrimeSTACK™, PRO-SIL™, PROFET™, RASIC™, ReverSave™, SatRIC™, SIEGET™, SINDRION™, SIPMOS™, SMARTi™, SmartLEWIS™, SOLID FLASH™, TEMPFET™, thinQ!™, TRENCHSTOP™, TriCore™, X-GOLD™, X-PMU™, XMM™, XPOSYS™.

Other Trademarks

Advance Design System™ (ADS) of Agilent Technologies, AMBA™, ARM™, MULTI-ICE™, KEIL™, PRIMECELL™, REALVIEW™, THUMB™, μVision™ of ARM Limited, UK. AUTOSAR™ is licensed by AUTOSAR development partnership. Bluetooth™ of Bluetooth SIG Inc. CAT-iq™ of DECT Forum. COLOSSUS™, FirstGPS™ of Trimble Navigation Ltd. EMV™ of EMVCo, LLC (Visa Holdings Inc.). EPCOS™ of Epcos AG. FLEXGO™ of Microsoft Corporation. FlexRay™ is licensed by FlexRay Consortium. HYPERTERMINAL™ of Hilgraeve Incorporated. IEC™ of Commission Electrotechnique Internationale. IrDA™ of Infrared Data Association Corporation. ISO™ of INTERNATIONAL ORGANIZATION FOR STANDARDIZATION. MATLAB™ of MathWorks, Inc. MAXIM™ of Maxim Integrated Products, Inc. MICROTEC™, NUCLEUS™ of Mentor Graphics Corporation. Mifare™ of NXP. MIPI™ of MIPI Alliance, Inc. MIPS™ of MIPS Technologies, Inc., USA. muRata™ of MURATA MANUFACTURING CO., MICROWAVE OFFICE™ (MWO) of Applied Wave Research Inc., OmniVision™ of OmniVision Technologies, Inc. Openwave™ Openwave Systems Inc. RED HAT™ Red Hat, Inc. RFMD™ RF Micro Devices, Inc. SIRIUS™ of Sirius Satellite Radio Inc. SOLARIS™ of Sun Microsystems, Inc. SPANSION™ of Spansion LLC Ltd. Symbian™ of Symbian Software Limited. TAIYO YUDEN™ of Taiyo Yuden Co. TEAKLITE™ of CEVA, Inc. TEKTRONIX™ of Tektronix Inc. TOKO™ of TOKO KABUSHIKI KAISHA TA. UNIX™ of X/Open Company Limited. VERILOG™, PALLADIUM™ of Cadence Design Systems, Inc. VLYNQ™ of Texas Instruments Incorporated. VXWORKS™, WIND RIVER™ of WIND RIVER SYSTEMS, INC. ZETEX™ of Diodes Zetex Limited.

Last Trademarks Update 2010-10-26

www.infineon.com

Published by Infineon Technologies AG

Downloaded From [Oneyac.com](https://www.oneyac.com)

单击下面可查看定价，库存，交付和生命周期等信息

[>>Infineon\(英飞凌\)](#)