

5th Generation CoolSiC™ 1200V Schottky Diode

SiC Diode

Features

- No reverse recovery current / no forward recovery
- High surge current capability
- Temperature independent switching behaviour
- Low forward voltage even at high operating temperature
- Tight forward voltage distribution
- Specified dv/dt ruggedness
- Pb-free lead plating; RoHS compliant



Pin definition

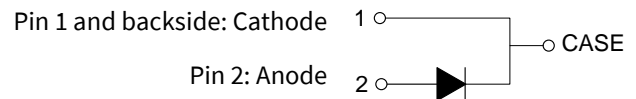

Potential applications

- Industrial power supplies: Industrial UPS
- Infrastructure-Charge: Charger
- Metal treatment: Welding
- Solar central inverters, Solar string inverter and Solar optimizer

Product validation

Qualified for industrial applications according to the relevant tests of JEDEC 47/20/22

Description

- System efficiency improvement over Si diodes
- Enabling higher frequency / increased power density solutions
- System size/cost savings due to reduced heatsink requirements and smaller magnetics
- Reduced EMI
- Highest efficiency across the entire load range
- Robust diode operation during surge events
- High reliability
- Related Links: www.infineon.com/SiC



Key performance parameters

Type	V _{DC}	I _F	Q _c	T _{vj,max}	Marking	Package
IDWD30G120C5	1200 V	30 A	154nC	175°C	D3012C5	PG-TO247-2



Table of contents

Features	1
Potential applications	1
Product validation	1
Description	1
Key performance parameters.....	1
Table of contents.....	2
1 Maximum ratings	3
2 Thermal resistances	5
3 Electrical Characteristics	6
4 Electrical Characteristics Diagrams	7
5 Package Drawing	10
Revision history.....	11

Maximum ratings

1 Maximum ratings

Note: For optimum lifetime and reliability, Infineon recommends operating conditions that do not exceed 80% of the maximum ratings stated in this datasheet.

Parameter	Symbol	Value	Unit
Repetitive peak reverse voltage $T_C \geq 25^\circ\text{C}$	V_{RRM}	1200	V
Continuous forward current for $R_{th(j-c,max)}$ $T_C = 156^\circ\text{C}, D=1$ $T_C = 135^\circ\text{C}, D=1$ $T_C = 25^\circ\text{C}, D=1$	I_F	30 40 87	A
Surge repetitive forward current, sine halfwave ¹ $T_C=25^\circ\text{C}, t_p=10\text{ms}$ $T_C=100^\circ\text{C}, t_p=10\text{ms}$	$I_{F,RM}$	120 90	A
Surge non-repetitive forward current, sine halfwave $T_C=25^\circ\text{C}, t_p=10\text{ms}$ $T_C=150^\circ\text{C}, t_p=10\text{ms}$	$I_{F,SM}$	240 230	A
Non-repetitive peak forward current $T_C = 25^\circ\text{C}, t_p=10 \mu\text{s}$	$I_{F,max}$	2460	A
i^2t value $T_C = 25^\circ\text{C}, t_p=10 \text{ms}$ $T_C = 150^\circ\text{C}, t_p=10 \text{ms}$	$\int i^2 dt$	288 264	A ² s
Diode dv/dt ruggedness $V_R=0\dots960 \text{V}$	dv/dt	150	V/ns
Power dissipation for $R_{th(j-c,max)}$ $T_C = 25^\circ\text{C}$	P_{tot}	332	W

¹ Not subject to production test. The test was performed with 20000 pulses (two consecutive half-wave rectified sines with 10 ms period).

5th Generation CoolSiC™ 1200V Schottky Diode

SiC Diode



Maximum ratings

Operating temperature	T_{vj}	-55...175	°C
Storage temperature	T_{stg}	-55...150	°C
Soldering temperature, wave soldering only allowed at leads 1.6mm (0.063 in.) from case for 10 s	T_{sold}	260	°C
Mounting torque, M3 screw Maximum of mounting processes: 3	M	0.6	Nm

2 Thermal resistances

Parameter	Symbol	Conditions	Value			Unit
			min.	typ.	max.	
Characteristic						
Diode thermal resistance, junction – case	$R_{th(j-c)}$		-	0.35	0.5	K/W
Thermal resistance, junction – ambient	$R_{th(j-a)}$	leaded	-	-	62	K/W

3 Electrical Characteristics

Static Characteristics, at $T_{vj}=25^{\circ}\text{C}$, unless otherwise specified

Parameter	Symbol	Conditions	Value			Unit
			min.	typ.	max.	
DC blocking voltage	V_{DC}	$T_{vj}=25^{\circ}\text{C}$, $I_R=500\mu\text{A}$	1200	-	-	V
Diode forward voltage	V_F	$I_F=30\text{A}$, $T_{vj}=25^{\circ}\text{C}$	-	1.4	1.65	V
		$I_F=30\text{A}$, $T_{vj}=150^{\circ}\text{C}$	-	1.7	-	
Reverse current	I_R	$V_R=1200\text{V}$, $T_{vj}=25^{\circ}\text{C}$	-	17	248	μA
		$V_R=1200\text{V}$, $T_{vj}=150^{\circ}\text{C}$	-	88	-	

Dynamic Characteristics, at $T_{vj}=25^{\circ}\text{C}$, unless otherwise specified

Parameter	Symbol	Conditions	Value			Unit
			min.	typ.	max.	
Total capacitive charge	Q_C	$V_R=800\text{V}$, $T_{vj}=150^{\circ}\text{C}$ & 25°C $Q_C = \int_0^{V_R} C(V)dV$	-	154	-	nC
Total Capacitance	C	$V_R=1\text{V}$, $f=1\text{MHz}$	-	1980	-	pF
		$V_R=400\text{V}$, $f=1\text{MHz}$	-	140	-	
		$V_R=800\text{V}$, $f=1\text{MHz}$	-	111	-	

4 Electrical Characteristics Diagrams

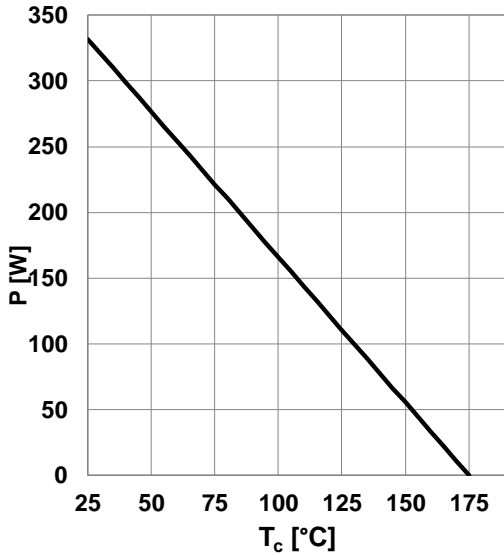

Figure 1. Power dissipation as function of case temperature, $P_{tot}=f(T_C)$, $R_{th(j-c),max}$

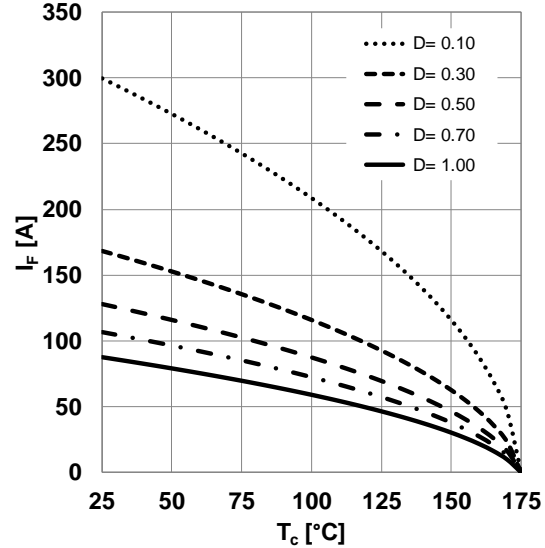

Figure 2. Diode forward current as function of temperature, parameter: $T_{vj} \leq 175^\circ C$, $R_{th(j-c),max}$, D =duty cycle, V_{th} , R_{diff} @ $T_{vj}=175^\circ C$

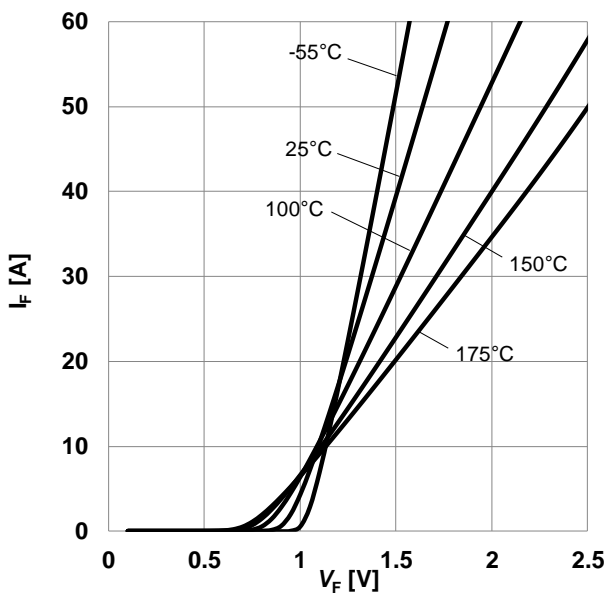

Figure 3. Typical forward characteristics, $I_F=f(V_F)$, $t_p=10 \mu s$, parameter: T_{vj}

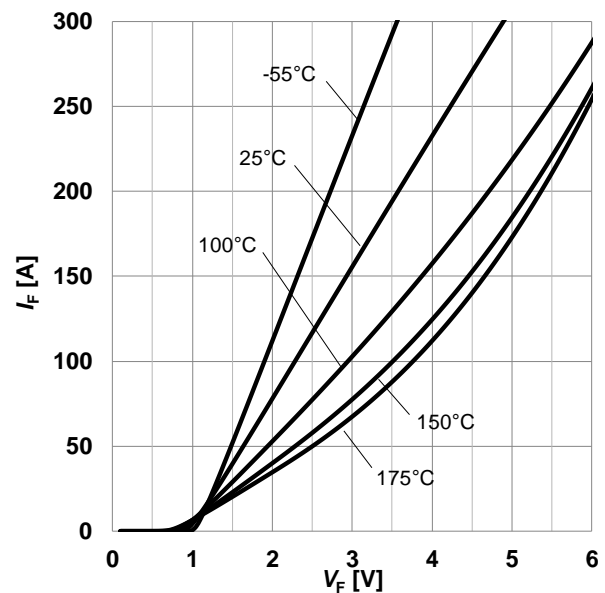

Figure 4. Typical forward characteristics in surge current, $I_F=f(V_F)$, $t_p=10 \mu s$, parameter: T_{vj}

Electrical Characteristics Diagrams

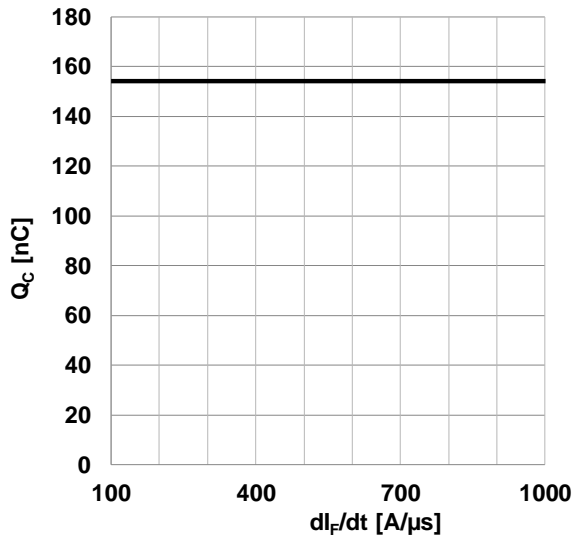

Figure 5. Typical capacitive charge as function of current slope², $Q_C=f(dI_F/dt)$, $T_{vj}=150^{\circ}C$

2) guaranteed by design

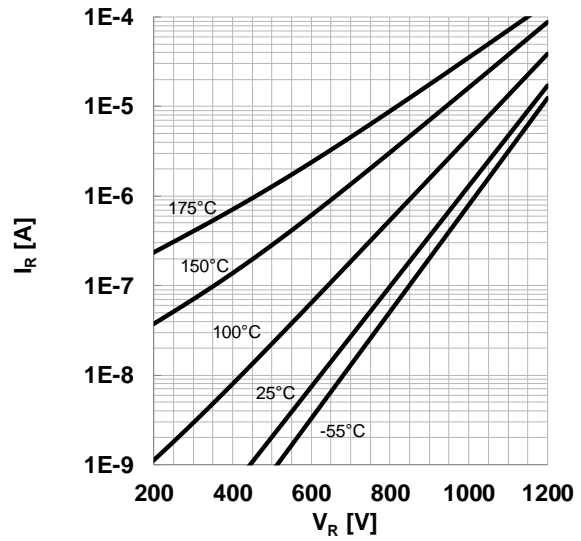

Figure 6. Typical reverse characteristics, $I_R=f(V_R)$, parameter: T_{vj}

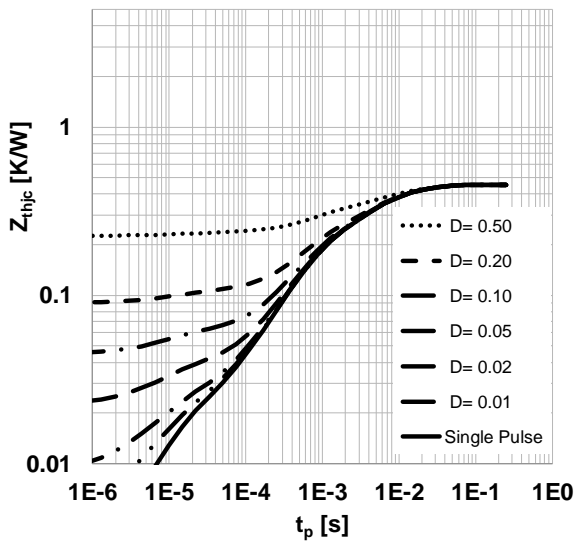

Figure 7. Max. transient thermal impedance, $Z_{th,j-c}=f(t_p)$, parameter: $D=t_p/T$

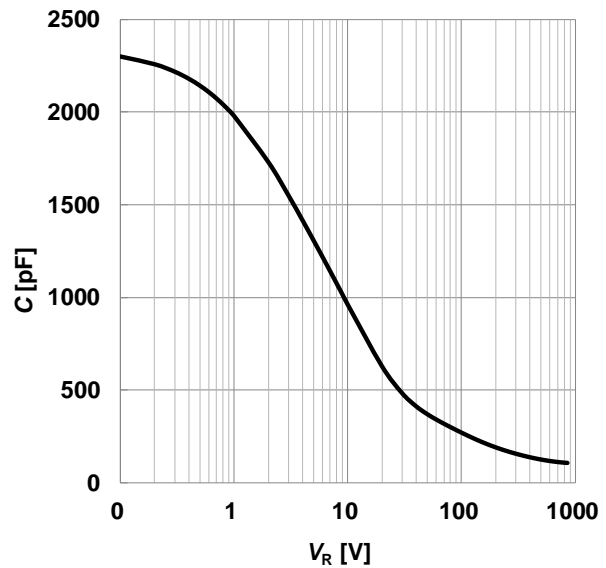

Figure 8. Typical capacitance as function of reverse voltage, $C=f(V_R)$; $T_{vj}=25^{\circ}C$; $f=1\text{ MHz}$

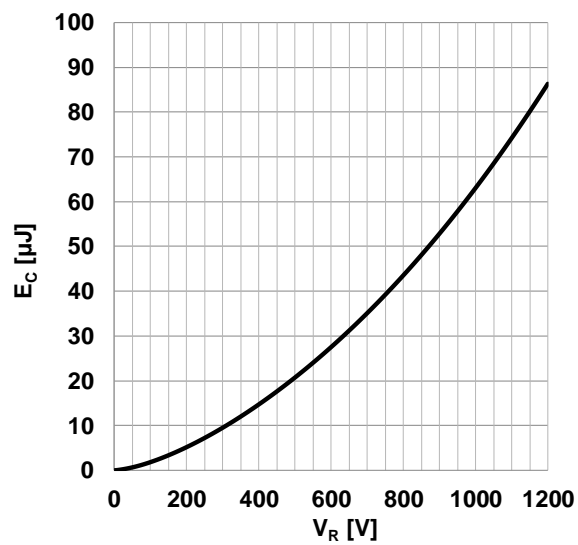
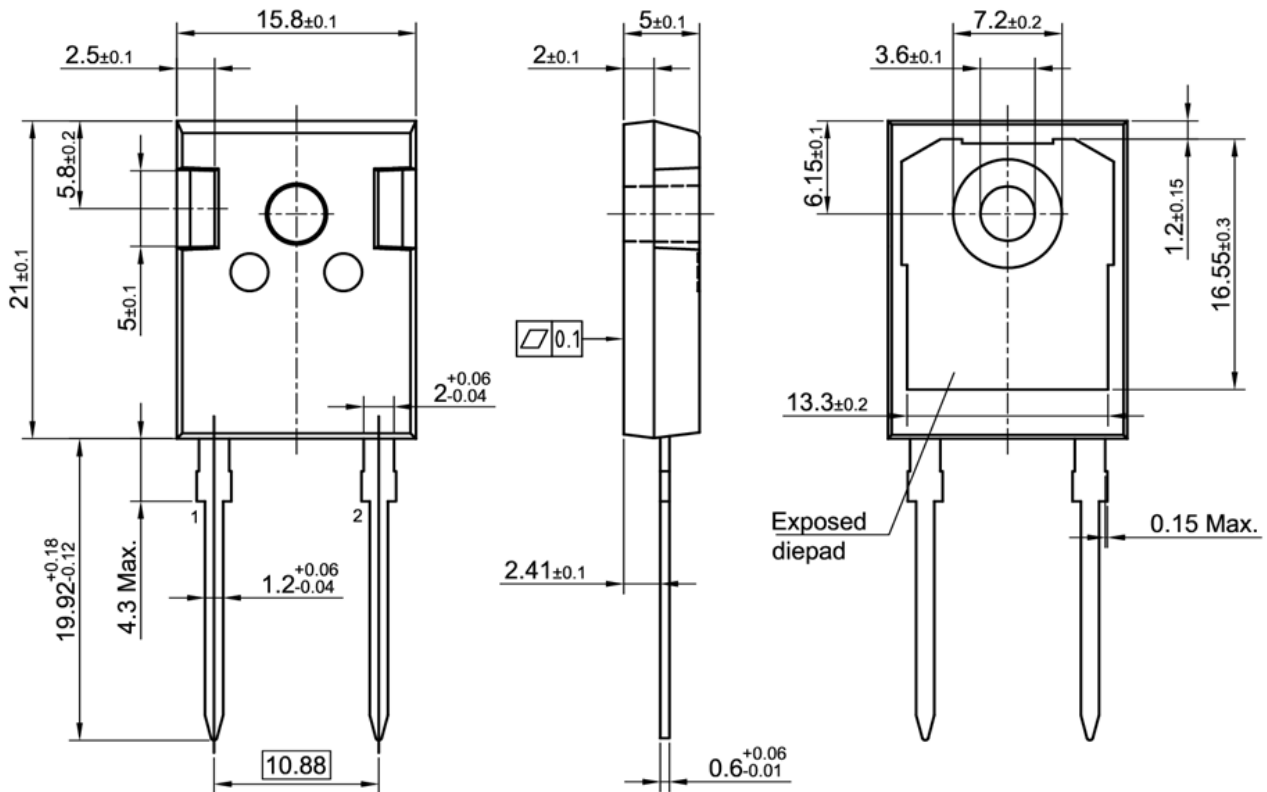

Figure 9. Typical capacitively stored energy as function of reverse voltage, $E_C=f(V_R)$

5 Package Drawing

PG-TO247-2



All dimensions do not include mold flash or protrusions

All dimensions are in units mm

The drawing is in compliance with ISO 128-30, Projection Method 1 []

Revision history

Revision history

Document version	Date of release	Description of changes
V 1.0	2018-12-21	Preliminary Datasheet
V 2.0	2019-01-30	Final Datasheet
V 2.1	2021-03-01	Increased dv/dt ruggedness

Trademarks

All referenced product or service names and trademarks are the property of their respective owners.

Edition 2021-03-01

Published by

Infineon Technologies AG

81726 München, Germany

© 2021 Infineon Technologies AG.

All Rights Reserved.

Do you have a question about this document?

Email: erratum@infineon.com

Document reference

n.a.

IMPORTANT NOTICE

The information given in this document shall in no event be regarded as a guarantee of conditions or characteristics ("Beschaffenheitsgarantie").

With respect to any examples, hints or any typical values stated herein and/or any information regarding the application of the product, Infineon Technologies hereby disclaims any and all warranties and liabilities of any kind, including without limitation warranties of non-infringement of intellectual property rights of any third party.

In addition, any information given in this document is subject to customer's compliance with its obligations stated in this document and any applicable legal requirements, norms and standards concerning customer's products and any use of the product of Infineon Technologies in customer's applications.

The data contained in this document is exclusively intended for technically trained staff. It is the responsibility of customer's technical departments to evaluate the suitability of the product for the intended application and the completeness of the product information given in this document with respect to such application.

For further information on the product, technology, delivery terms and conditions and prices please contact your nearest Infineon Technologies office (www.infineon.com).

Please note that this product is not qualified according to the AEC Q100 or AEC Q101 documents of the Automotive Electronics Council.

WARNINGS

Due to technical requirements products may contain dangerous substances. For information on the types in question please contact your nearest Infineon Technologies office.

Except as otherwise explicitly approved by Infineon Technologies in a written document signed by authorized representatives of Infineon Technologies, Infineon Technologies' products may not be used in any applications where a failure of the product or any consequences of the use thereof can reasonably be expected to result in personal injury.

单击下面可查看定价，库存，交付和生命周期等信息

[>>Infineon\(英飞凌\)](#)