

Thermally-Enhanced High Power RF LDMOS FET 28 W, 28 V, 1800 – 2200 MHz

Description

The PTFC210202FC integrates two independent 10-watt LDMOS FETs and is designed for use in cellular amplifier applications in the 2110 to 2170 MHz frequency band. Manufactured with Infineon's advanced LDMOS process, this device provides excellent thermal performance and superior reliability.

PTFC210202FC
Package H-37248-4

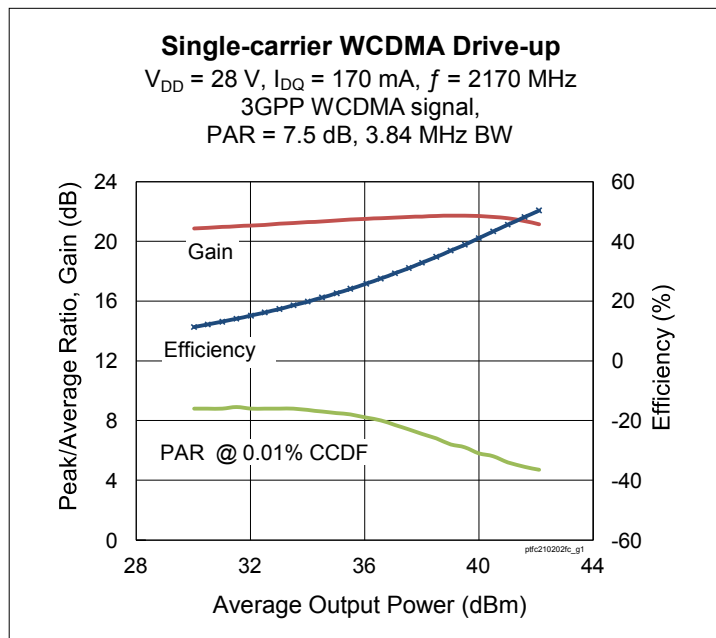

Features

- Input matched
- Typical CW performance, 2170 MHz, 28 V, combined outputs
 - Output power at $P_{1dB} = 28\text{ W}$
 - Efficiency = 62%
 - Gain = 20.9 dB
- Capable of handling 10:1 VSWR @ 28 V, 28 W (CW) output power
- Integrated ESD protection : Human Body Model, Class 1C (per JESD22-A114)
- Low thermal resistance
- Pb-free and RoHS compliant

RF Characteristics

Single-carrier WCDMA Specifications (tested in Infineon test fixture)

$V_{DD} = 28\text{ V}$, $I_{DQ} = 170\text{ mA}$, $P_{OUT} = 5\text{ W avg}$, $f_1 = 2160\text{ MHz}$, $f_2 = 2170\text{ MHz}$, 3GPP signal, channel bandwidth = 3.84 MHz, peak/average = 8 dB @ 0.01% CCDF

Characteristic	Symbol	Min	Typ	Max	Unit
Linear Gain	G_{ps}	20	21	—	dB
Drain Efficiency	η_D	26.5	29	—	%
Adjacent Channel Power Ratio	ACPR	—	-31	-28	dBc

All published data at $T_{CASE} = 25^\circ\text{C}$ unless otherwise indicated

ESD: Electrostatic discharge sensitive device—observe handling precautions!

DC Characteristics (each side)

Characteristic	Conditions	Symbol	Min	Typ	Max	Unit
Drain-Source Breakdown Voltage	$V_{GS} = 0\text{ V}, I_{DS} = 10\text{ mA}$	$V_{(BR)DSS}$	65	—	—	V
Drain Leakage Current	$V_{DS} = 28\text{ V}, V_{GS} = 0\text{ V}$	I_{DSS}	—	—	0.1	μA
	$V_{DS} = 63\text{ V}, V_{GS} = 0\text{ V}$	I_{DSS}	—	—	1.0	μA
Gate Leakage Current	$V_{GS} = 10\text{ V}, V_{DS} = 0\text{ V}$	I_{GSS}	—	—	1	μA
On-State Resistance	$V_{GS} = 10\text{ V}, V_{DS} = 0.1\text{ V}$	$R_{DS(on)}$	—	0.05	—	Ω
Operating Gate Voltage	$V_{DS} = 28\text{ V}, I_{DQ} = 0.17$	V_{GS}	2.40	2.70	3.05	V

Maximum Ratings

Parameter	Symbol	Value	Unit
Drain-Source Voltage	V_{DSS}	65	V
Gate-Source Voltage	V_{GS}	-6 to +10	V
Operating Voltage	V_{DD}	0 to +32	
Junction Temperature	T_J	225	$^{\circ}\text{C}$
Storage Temperature Range	T_{STG}	-65 to +150	$^{\circ}\text{C}$
Thermal Resistance ($T_{CASE} = 70^{\circ}\text{C}, 25\text{ W CW}$)	$R_{\theta JC}$	2.2	$^{\circ}\text{C/W}$

Ordering Information

Type and Version	Order Code	Package Description	Shipping
PTFC210202FC V1 R0	PTFC210202FCV1R0XTMA1	H-37248-4, earless flange	Tape & Reel, 50 pcs
PTFC210202FC V1 R250	PTFC210202FCV1R250XTMA1	H-37248-4, earless flange	Tape & Reel, 250 pcs

Typical Performance (data taken in a production test fixture)

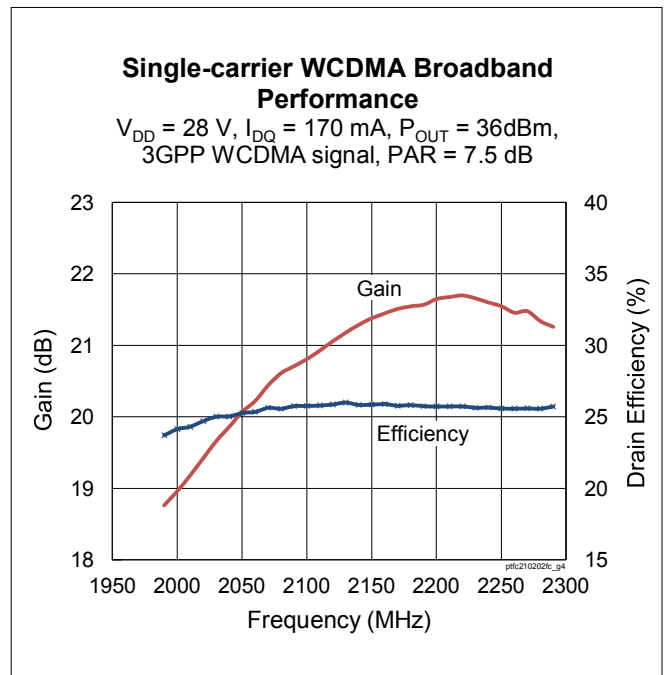
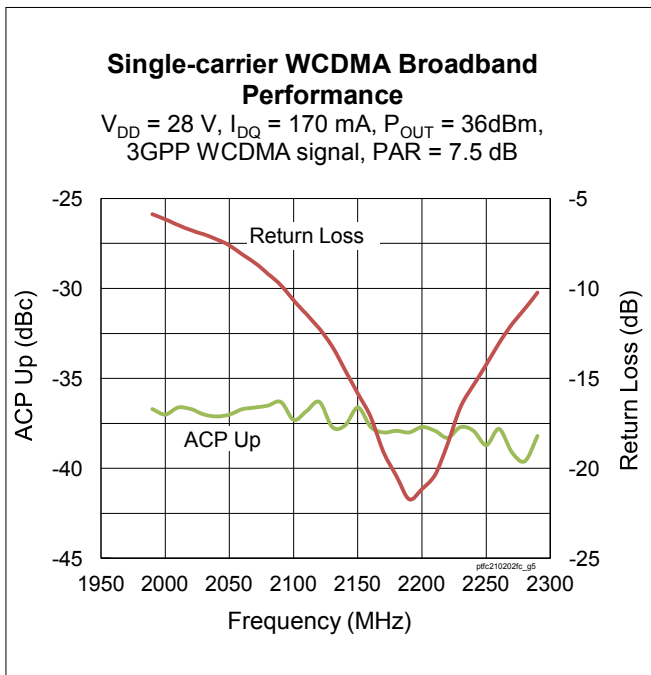
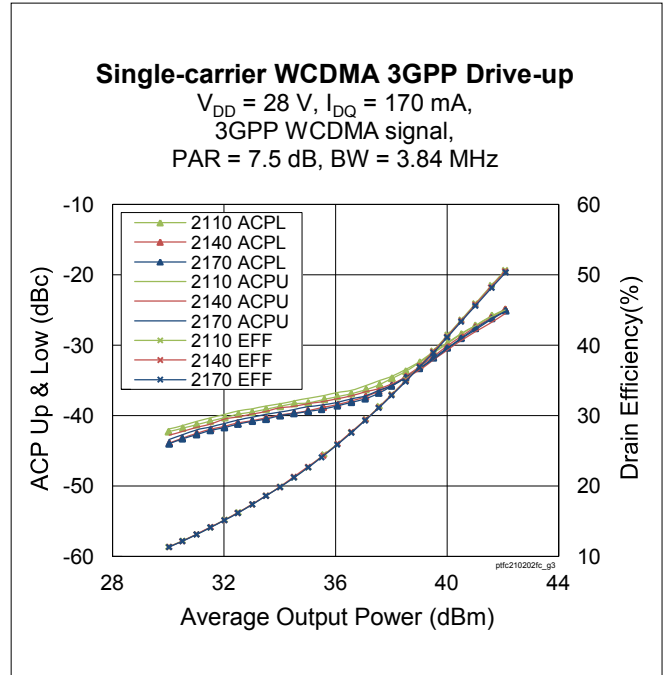
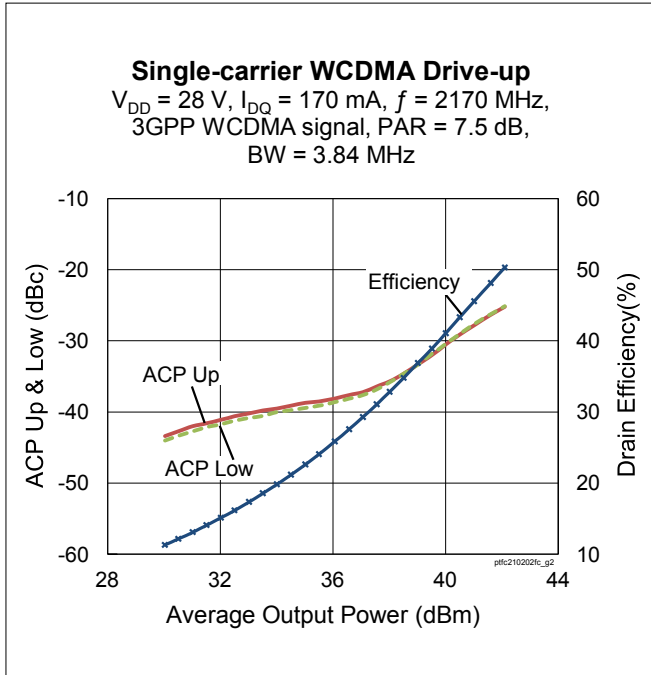

Typical Performance (cont.)

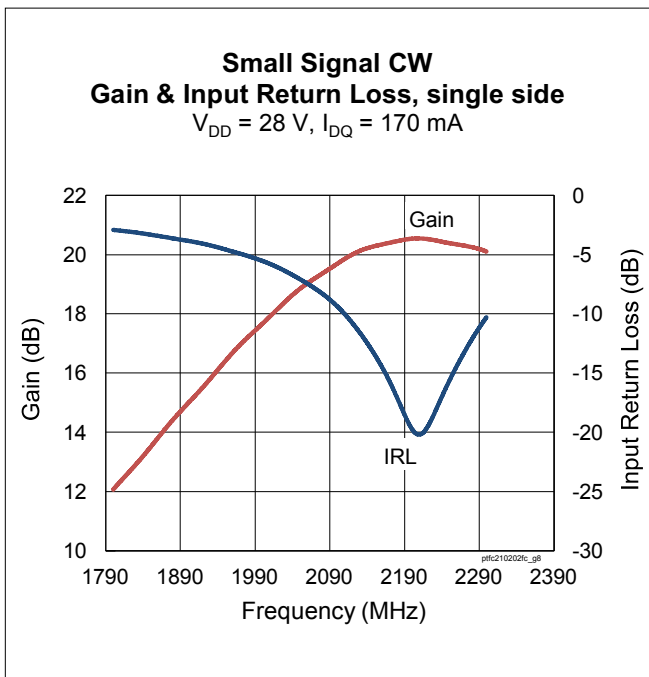
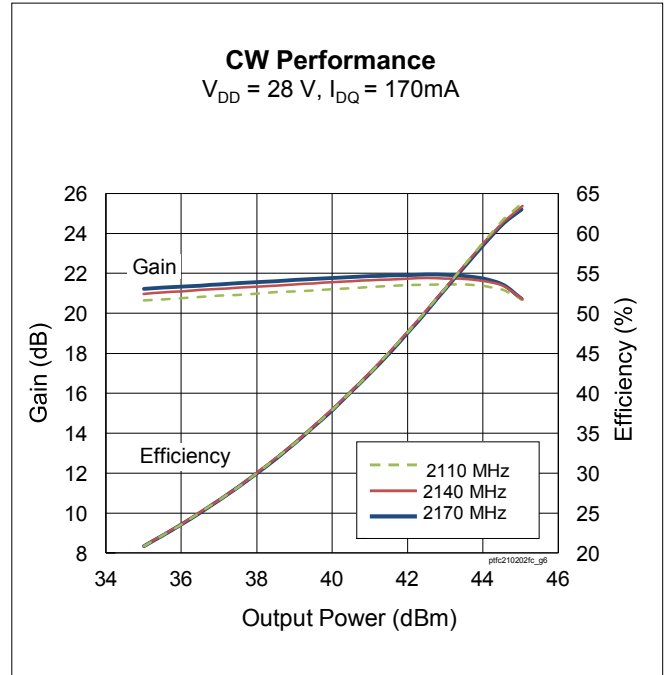
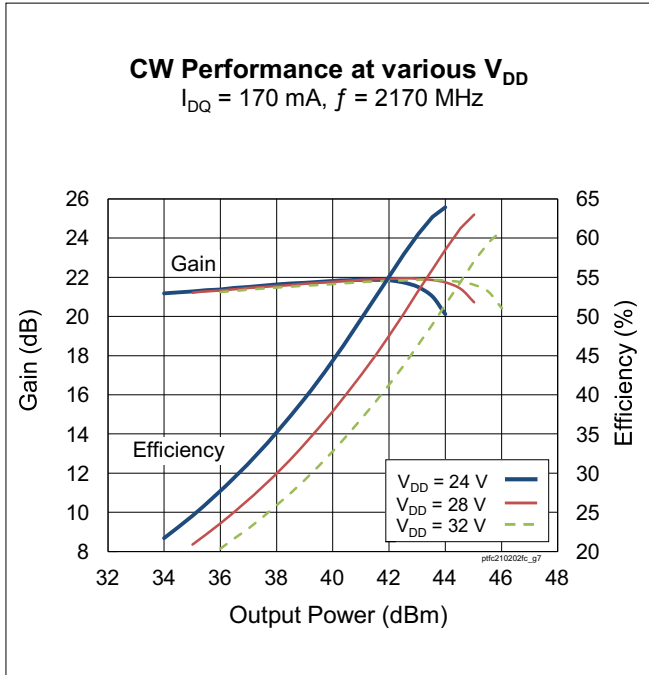

Broadband Circuit Impedance

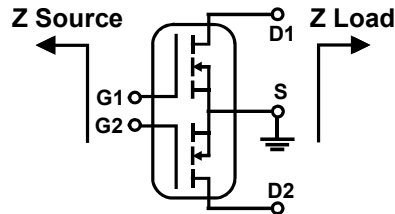

Frequency MHz	Z Source Ω		Z Load Ω	
	R	jX	R	jX
2110	4.86	-0.01	3.59	-2.65
2120	4.89	-0.01	3.63	-2.65
2130	4.92	-0.01	3.68	-2.66
2140	4.95	-0.01	3.72	-2.68
2150	4.98	-0.02	3.76	-2.69
2160	5.00	-0.02	3.81	-2.71
2170	5.03	-0.03	3.85	-2.73

Load Pull Performance

Each Side Load Pull Performance – CW signal; $V_{DD} = 28\text{ V}$, 85 mA

Freq [MHz]	Zs [Ω]	P _{1dB}									
		Max Output Power					Max PAE				
		ZI [Ω]	Gain [dB]	P _{OUT} [dBm]	P _{OUT} [W]	PAE [%]	ZI [Ω]	Gain [dB]	P _{OUT} [dBm]	P _{OUT} [W]	PAE [%]
2110	15.9 – j19.7	6.7 – j5.6	21.7	42.67	18.5	58.7	5.3 – j2.3	23.7	41.25	13.3	67.8
2140	15.7 – j18.8	7.6 – j4.9	22.3	42.16	16.4	60.5	4.9 – j2.3	24.1	40.89	12.3	67.3
2170	17.1 – j17.7	7.0 – j5.7	22.1	42.08	16.2	59.2	4.8 – j2.9	23.9	40.87	12.2	66.6

Reference Circuit

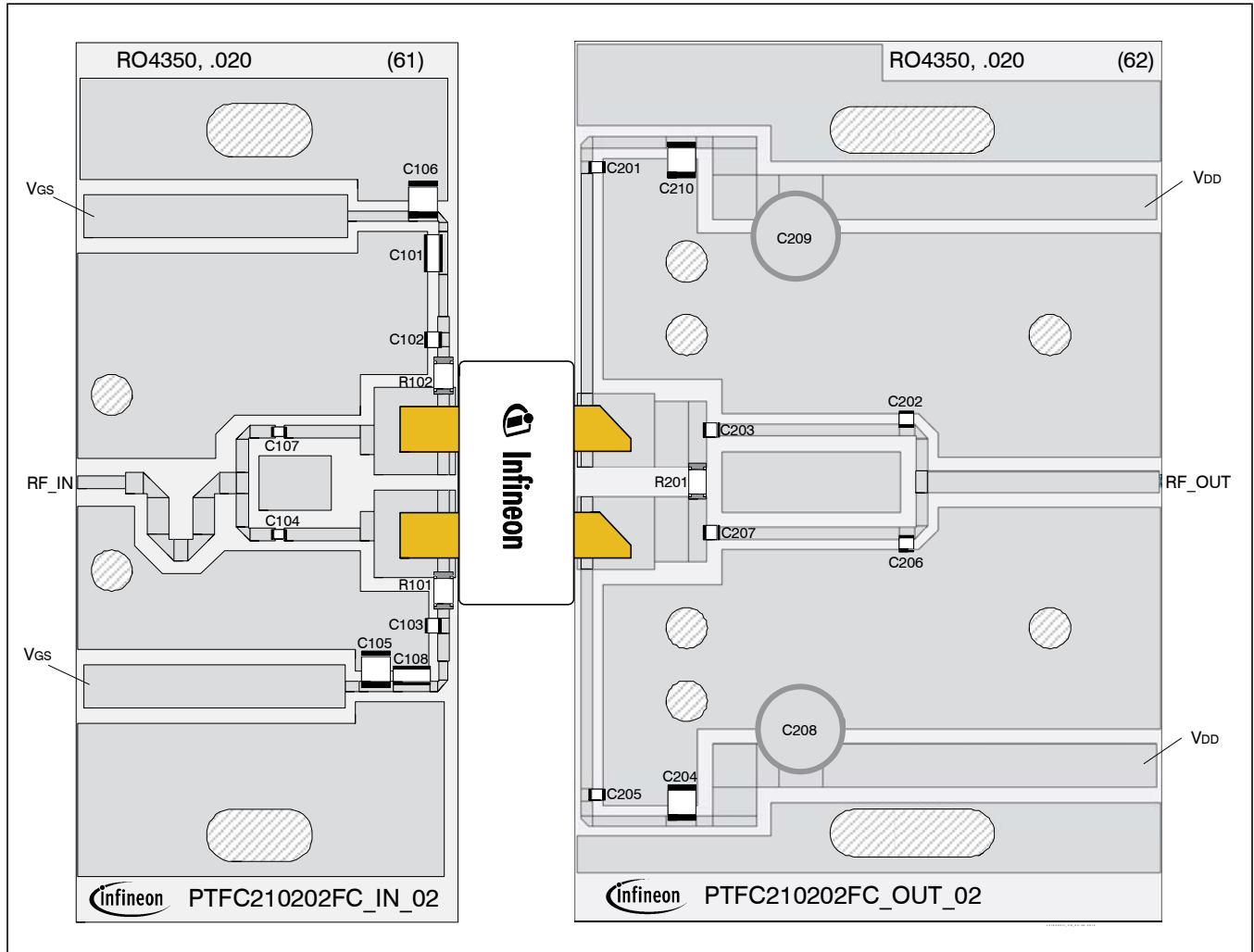

Reference circuit assembly diagram (not to scale)

Reference Circuit (cont.)

Reference Circuit Assembly

DUT	PTFC210202FC
Test Fixture Part No.	LTN/PTFC210202FC
PCB	Rogers 4350, 0.508 mm [0.020"] thick, 2 oz. copper, $\epsilon_r = 3.66$
Find Gerber files for this test fixture on the Infineon Web site at http://www.infineon.com/rfpower	

Components Information

Component	Description	Suggested Manufacturer	P/N
Input			
C101, C108	Capacitor, 10 μF	TDK Corporation	C5750X5R1H106K230KA
C102, C103	Chip capacitor, 20 pF	ATC	ATC100A200JW150XB
C104, C107	Chip capacitor, 5.1 pF	ATC	ATC100A5R1CW250XT
C105, C106	Chip capacitor, 10 μF	Taiyo Yuden	UMK325C7106MM-T
R101, R102	Resistor, 10 Ω	Panasonic Electronic Components	ERJ-8GEYJ100V
Output			
C201, C205	Chip capacitor, 20 pF	ATC	ATC100A200JW250XT
C202, C203, C206, C207	Chip capacitor, 1.6 pF	ATC	ATC800A1R6BT250XT
C204, C210	Chip capacitor, 10 μF	Taiyo Yuden	UMK325C7106MM-T
C208, C09	Capacitor, 100 μF	Panasonic Electronic Components	ECA-1HHG101
R201	Resistor, 10 Ω	ATC	CR11206T0100J

Pinout Diagram (top view)

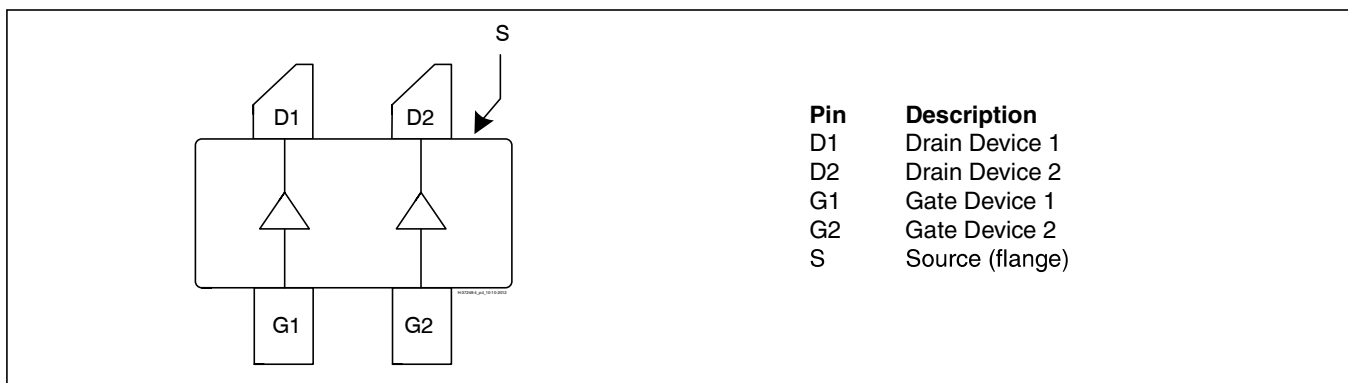

Lead connections for PTFC210202FC

Package Outline Specifications

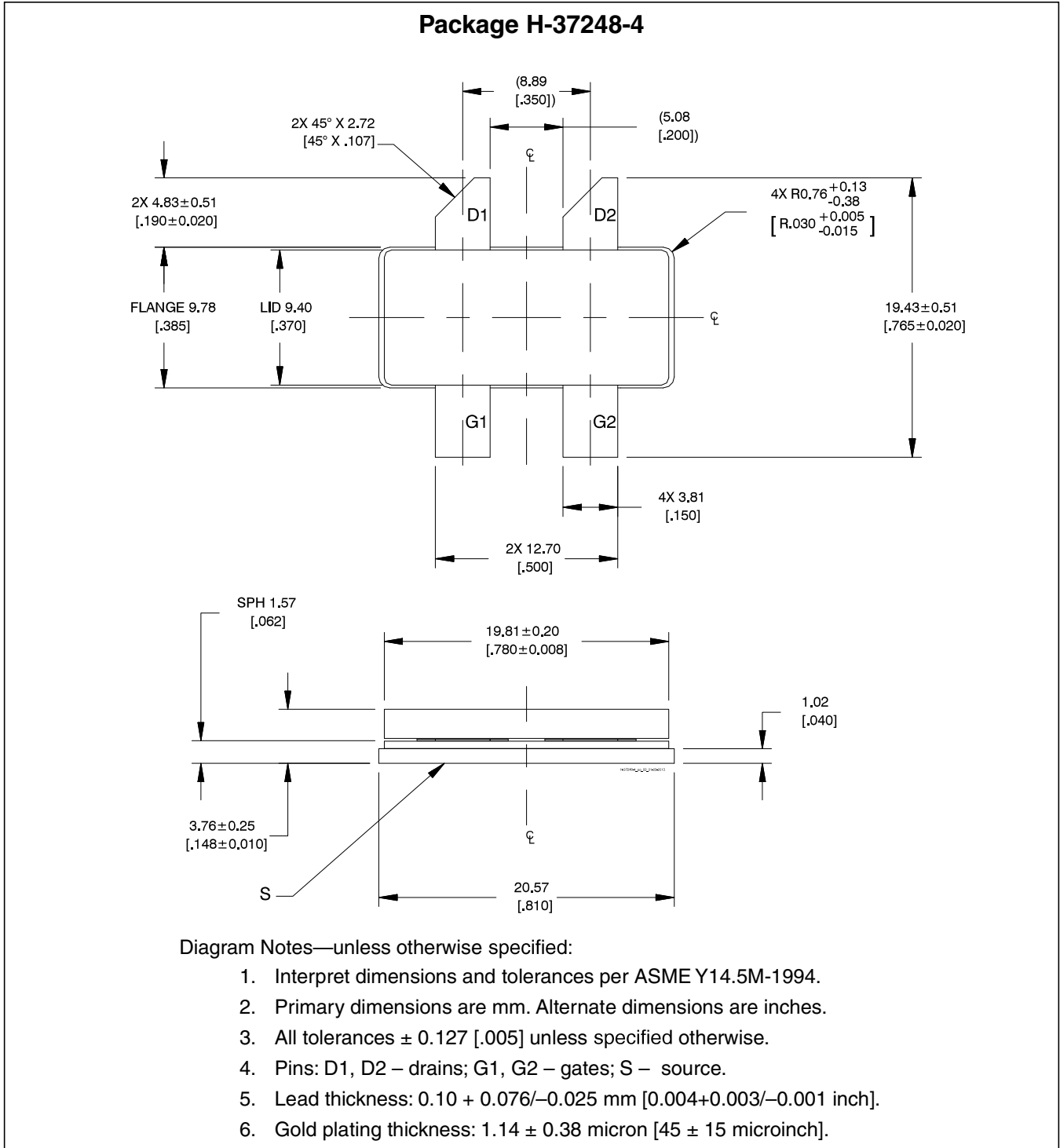

Find the latest and most complete information about products and packaging at the Infineon Internet page <http://www.infineon.com/rfpower>

Revision History

Revision	Date	Data Sheet Type	Page	Subjects (major changes since last revision)
01	2012-11-15	Advance	All	Data Sheet reflects advance specification for product development
02p	2012-12-19	Preliminary	All	Data Sheet reflects preliminary specification
03	2013-03-11	Production	All	Data Sheet reflects released product specification
03.1	2013-06-27	Production	1 2	Classified ESD protection Added operating voltage
03.2	2014-05-14	Production	2	Revised junction temperature in Maximum Ratings table
03.3	2015-12-23	Production	2	DC Characteristic table
03.4	2016-06-22	Production	2	Updated ordering information

We Listen to Your Comments

Any information within this document that you feel is wrong, unclear or missing at all?
Your feedback will help us to continuously improve the quality of this document.
Please send your proposal (including a reference to this document) to:

highpowerRF@infineon.com

To request other information, contact us at:
+1 877 465 3667 (1-877-GO-LDMOS) USA
or +1 408 776 0600 International

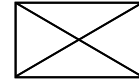

Edition 2016-06-22

Published by
Infineon Technologies AG
85579 Neubiberg, Germany

© 2014 Infineon Technologies AG
All Rights Reserved.

Legal Disclaimer

The information given in this document shall in no event be regarded as a guarantee of conditions or characteristics. With respect to any examples or hints given herein, any typical values stated herein and/or any information regarding the application of the device, Infineon Technologies hereby disclaims any and all warranties and liabilities of any kind, including without limitation, warranties of non-infringement of intellectual property rights of any third party.

Information

For further information on technology, delivery terms and conditions and prices, please contact the nearest Infineon Technologies Office (www.infineon.com/rfpower).

Warnings

Due to technical requirements, components may contain dangerous substances. For information on the types in question, please contact the nearest Infineon Technologies Office.

Infineon Technologies components may be used in life-support devices or systems only with the express written approval of Infineon Technologies, if a failure of such components can reasonably be expected to cause the failure of that life-support device or system or to affect the safety or effectiveness of that device or system. Life support devices or systems are intended to be implanted in the human body or to support and/or maintain and sustain and/or protect human life. If they fail, it is reasonable to assume that the health of the user or other persons may be endangered.

单击下面可查看定价，库存，交付和生命周期等信息

[>>Infineon\(英飞凌\)](#)