

High speed switching series fifth generation

High speed fast IGBT in TRENCHSTOP™ 5 technology

Features and Benefits:

- High speed F5 technology offering:
- Best-in-Class efficiency in hard switching and resonant topologies
 - 650V breakdown voltage
 - Low gate charge Q_G
 - Maximum junction temperature 175°C
 - Dynamically stress tested
 - Qualified according to AEC-Q101
 - Green package (RoHS compliant)
 - Complete product spectrum and PSpice Models: <http://www.infineon.com/igbt/>

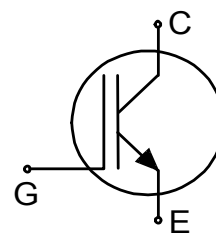

Applications:

- Off-board charger
- On-board charger
- DC/DC converter
- Power-factor correction

Package pin definition:

- Pin 1 - gate
- Pin 2 & backside - collector
- Pin 3 - emitter



Key Performance and Package Parameters

Type	V_{CE}	I_C	$V_{CEsat}, T_{vj}=25^\circ C$	T_{vjmax}	Marking	Package
AIGW50N65F5	650V	50A	1.66V	175°C	AG50EF5	PG-TO247-3



Table of Contents

Description 1

Table of Contents 2

Maximum Ratings 3

Thermal Resistance 3

Electrical Characteristics 3

Electrical Characteristics Diagrams 6

Package Drawing11

Testing Conditions12

Revision History13

Disclaimer14

High speed switching series fifth generation

Maximum Ratings

Parameter	Symbol	Value	Unit
Collector-emitter voltage, $T_{vj} \geq 25^{\circ}\text{C}$	V_{CE}	650	V
DC collector current, limited by T_{vjmax} $T_C = 25^{\circ}\text{C}$ value limited by bondwire $T_C = 100^{\circ}\text{C}$	I_C	80.0 53.5	A
Pulsed collector current, t_p limited by $T_{vjmax}^{1)}$	I_{Cpuls}	150.0	A
Turn off safe operating area $V_{CE} \leq 650\text{V}$, $T_{vj} \leq 175^{\circ}\text{C}$, $t_p = 1\mu\text{s}^{1)}$	-	150.0	A
Gate-emitter voltage Transient Gate-emitter voltage ($t_p \leq 10\mu\text{s}$, $D < 0.010$)	V_{GE}	± 20 ± 30	V
Power dissipation $T_C = 25^{\circ}\text{C}$ Power dissipation $T_C = 100^{\circ}\text{C}$	P_{tot}	270.0 136.0	W
Operating junction temperature	T_{vj}	-40...+175	$^{\circ}\text{C}$
Storage temperature	T_{stg}	-55...+150	$^{\circ}\text{C}$
Soldering temperature, ²⁾ wave soldering 1.6mm (0.063in.) from case for 10s		260	$^{\circ}\text{C}$
Mounting torque, M3 screw Maximum of mounting processes: 3	M	0.6	Nm

Thermal Resistance

Parameter	Symbol	Conditions	Value			Unit
			min.	typ.	max.	
IGBT thermal resistance, junction - case	$R_{th(j-c)}$		-	-	0.55	K/W
Thermal resistance junction - ambient	$R_{th(j-a)}$		-	-	40	K/W

 R_{th} CharacteristicsElectrical Characteristic, at $T_{vj} = 25^{\circ}\text{C}$, unless otherwise specified

Parameter	Symbol	Conditions	Value			Unit
			min.	typ.	max.	
Collector-emitter breakdown voltage	$V_{(BR)CES}$	$V_{GE} = 0\text{V}$, $I_C = 0.20\text{mA}$	650	-	-	V
Collector-emitter saturation voltage	V_{CEsat}	$V_{GE} = 15.0\text{V}$, $I_C = 50.0\text{A}$ $T_{vj} = 25^{\circ}\text{C}$ $T_{vj} = 125^{\circ}\text{C}$ $T_{vj} = 175^{\circ}\text{C}$	-	1.66 1.90 2.03	2.10 -	V
Gate-emitter threshold voltage	$V_{GE(th)}$	$I_C = 0.40\text{mA}$, $V_{CE} = V_{GE}$	3.2	4.0	4.8	V
Zero gate voltage collector current	I_{CES}	$V_{CE} = 650\text{V}$, $V_{GE} = 0\text{V}$ $T_{vj} = 25^{\circ}\text{C}$ $T_{vj} = 175^{\circ}\text{C}$	-	-	40	μA
Gate-emitter leakage current	I_{GES}	$V_{CE} = 0\text{V}$, $V_{GE} = 20\text{V}$	-	-	100	nA
Transconductance	g_{fs}	$V_{CE} = 20\text{V}$, $I_C = 50.0\text{A}$	-	62.0	-	S

¹⁾ Defined by design. Not subject to production test.

²⁾ Package not recommended for surface mount applications

High speed switching series fifth generation

Electrical Characteristic, at $T_{vj} = 25^{\circ}\text{C}$, unless otherwise specified

Parameter	Symbol	Conditions	Value			Unit
			min.	typ.	max.	
Dynamic Characteristic						
Input capacitance	C_{ies}	$V_{CE} = 25\text{V}, V_{GE} = 0\text{V}, f = 1\text{MHz}$	-	2800	-	pF
Output capacitance	C_{oes}		-	51	-	
Reverse transfer capacitance	C_{res}		-	11	-	
Gate charge	Q_G	$V_{CC} = 520\text{V}, I_C = 50.0\text{A}, V_{GE} = 15\text{V}$	-	108.0	-	nC
Internal emitter inductance measured 5mm (0.197 in.) from case	L_E		-	13.0	-	nH

Switching Characteristic, Inductive Load

Parameter	Symbol	Conditions	Value			Unit
			min.	typ.	max.	
IGBT Characteristic, at $T_{vj} = 25^{\circ}\text{C}$						
Turn-on delay time	$t_{d(on)}$	$T_{vj} = 25^{\circ}\text{C}, V_{CC} = 400\text{V}, I_C = 25.0\text{A}, V_{GE} = 0.0/15.0\text{V}, R_{G(on)} = 12.0\Omega, R_{G(off)} = 12.0\Omega, L_{\sigma} = 30\text{nH}, C_{\sigma} = 30\text{pF}$ Energy losses include "tail" and diode reverse recovery.	-	21	-	ns
Rise time	t_r		-	12	-	ns
Turn-off delay time	$t_{d(off)}$		-	156	-	ns
Fall time	t_f		-	6	-	ns
Turn-on energy	E_{on}		-	0.49	-	mJ
Turn-off energy	E_{off}		-	0.14	-	mJ
Total switching energy	E_{ts}		-	0.63	-	mJ
Turn-on delay time	$t_{d(on)}$	$T_{vj} = 25^{\circ}\text{C}, V_{CC} = 400\text{V}, I_C = 6.0\text{A}, V_{GE} = 0.0/15.0\text{V}, R_{G(on)} = 12.0\Omega, R_{G(off)} = 12.0\Omega, L_{\sigma} = 30\text{nH}, C_{\sigma} = 30\text{pF}$ Energy losses include "tail" and diode reverse recovery.	-	19	-	ns
Rise time	t_r		-	4	-	ns
Turn-off delay time	$t_{d(off)}$		-	173	-	ns
Fall time	t_f		-	10	-	ns
Turn-on energy	E_{on}		-	0.10	-	mJ
Turn-off energy	E_{off}		-	0.03	-	mJ
Total switching energy	E_{ts}		-	0.13	-	mJ

High speed switching series fifth generation

Switching Characteristic, Inductive Load

Parameter	Symbol	Conditions	Value			Unit
			min.	typ.	max.	
IGBT Characteristic, at $T_{vj} = 150^{\circ}\text{C}$						
Turn-on delay time	$t_{d(on)}$	$T_{vj} = 150^{\circ}\text{C}$, $V_{CC} = 400\text{V}$, $I_C = 25.0\text{A}$, $V_{GE} = 0.0/15.0\text{V}$, $R_{G(on)} = 12.0\Omega$, $R_{G(off)} = 12.0\Omega$, $L\sigma = 30\text{nH}$, $C\sigma = 30\text{pF}$ $L\sigma$, $C\sigma$ from Fig. E Energy losses include "tail" and diode reverse recovery.	-	21	-	ns
Rise time	t_r		-	14	-	ns
Turn-off delay time	$t_{d(off)}$		-	191	-	ns
Fall time	t_f		-	5	-	ns
Turn-on energy	E_{on}		-	0.68	-	mJ
Turn-off energy	E_{off}		-	0.25	-	mJ
Total switching energy	E_{ts}		-	0.93	-	mJ
<hr/>						
Turn-on delay time	$t_{d(on)}$	$T_{vj} = 150^{\circ}\text{C}$, $V_{CC} = 400\text{V}$, $I_C = 6.0\text{A}$, $V_{GE} = 0.0/15.0\text{V}$, $R_{G(on)} = 12.0\Omega$, $R_{G(off)} = 12.0\Omega$, $L\sigma = 30\text{nH}$, $C\sigma = 30\text{pF}$ $L\sigma$, $C\sigma$ from Fig. E Energy losses include "tail" and diode reverse recovery.	-	18	-	ns
Rise time	t_r		-	5	-	ns
Turn-off delay time	$t_{d(off)}$		-	229	-	ns
Fall time	t_f		-	12	-	ns
Turn-on energy	E_{on}		-	0.18	-	mJ
Turn-off energy	E_{off}		-	0.06	-	mJ
Total switching energy	E_{ts}		-	0.24	-	mJ

High speed switching series fifth generation

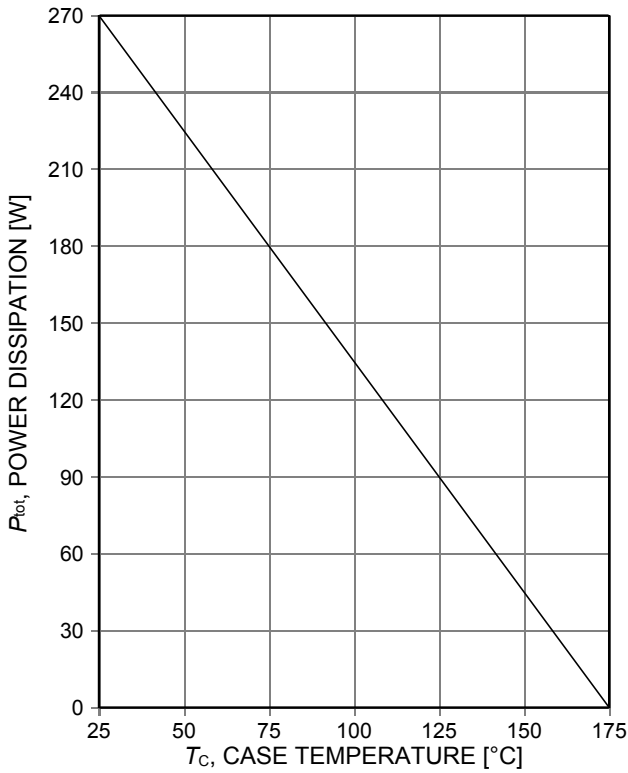

Figure 1. Power dissipation as a function of case temperature ($T_{vj} \leq 175^\circ\text{C}$)

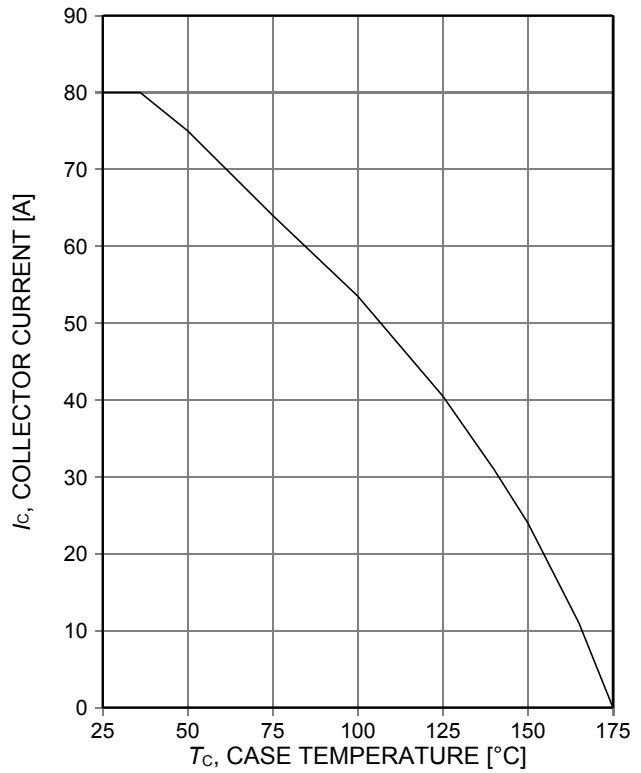

Figure 2. Collector current as a function of case temperature ($V_{GE} \geq 15\text{V}$, $T_{vj} \leq 175^\circ\text{C}$)

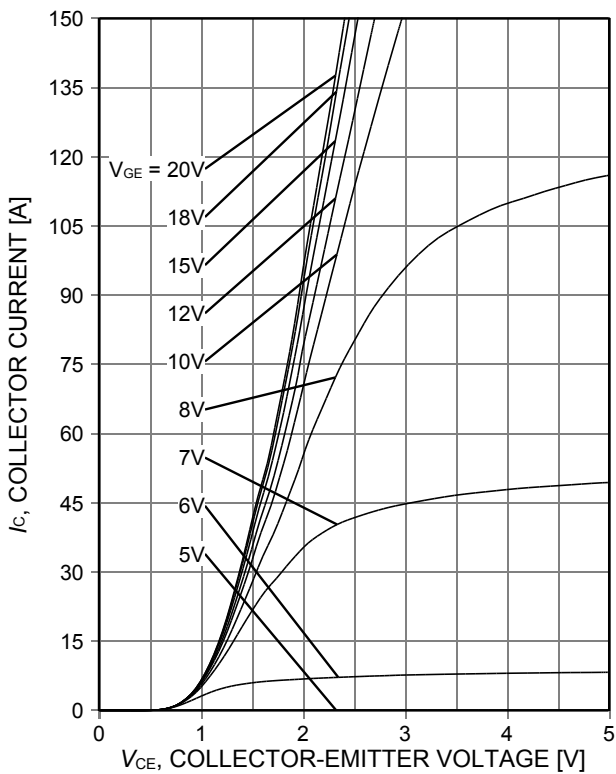

Figure 3. Typical output characteristic ($T_{vj} = 25^\circ\text{C}$)

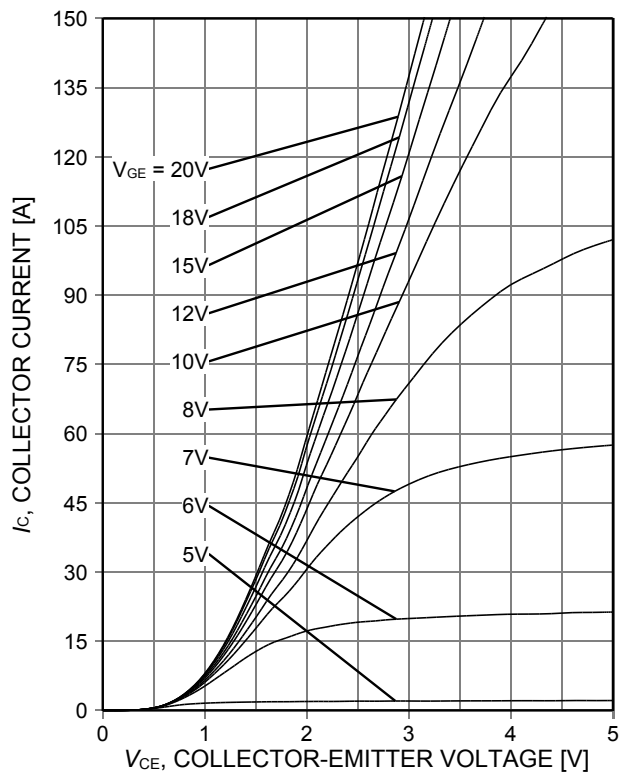

Figure 4. Typical output characteristic ($T_{vj} = 150^\circ\text{C}$)

High speed switching series fifth generation

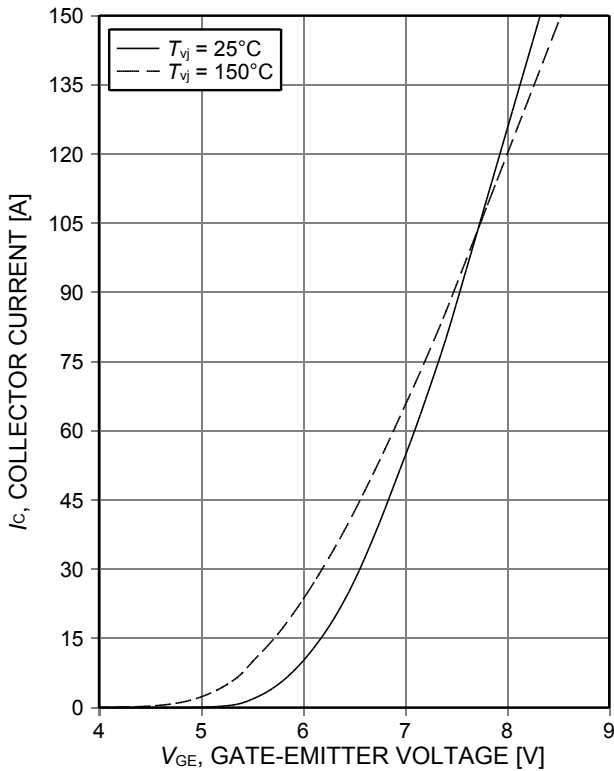

Figure 5. Typical transfer characteristic (V_{CE}=20V)

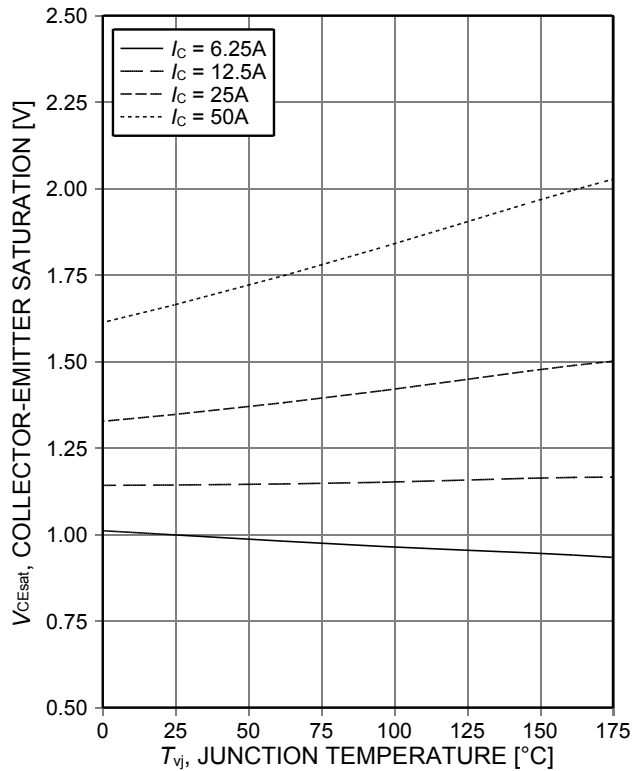

Figure 6. Typical collector-emitter saturation voltage as a function of junction temperature (V_{GE}=15V)

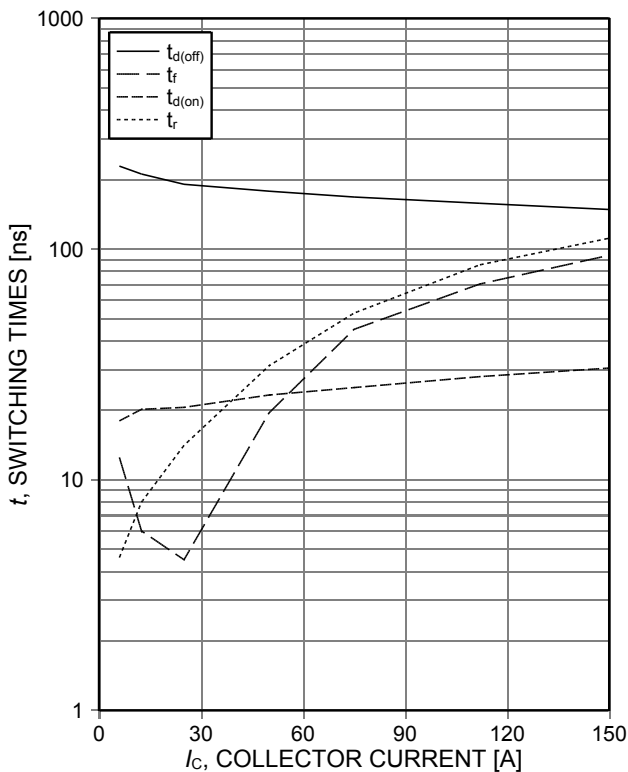

Figure 7. Typical switching times as a function of collector current (inductive load, T_{vj}=150°C, V_{CE}=400V, V_{GE}=0/15V, R_{G(on)}=12Ω, R_{G(off)}=12Ω, dynamic test circuit in Figure E)

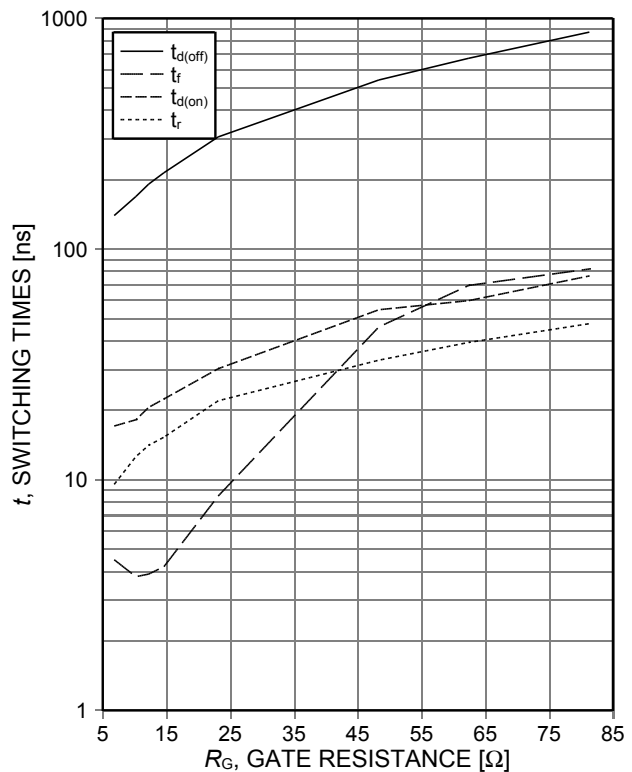

Figure 8. Typical switching times as a function of gate resistance (inductive load, T_{vj}=150°C, V_{CE}=400V, V_{GE}=0/15V, Ic=25A, dynamic test circuit in Figure E)

High speed switching series fifth generation

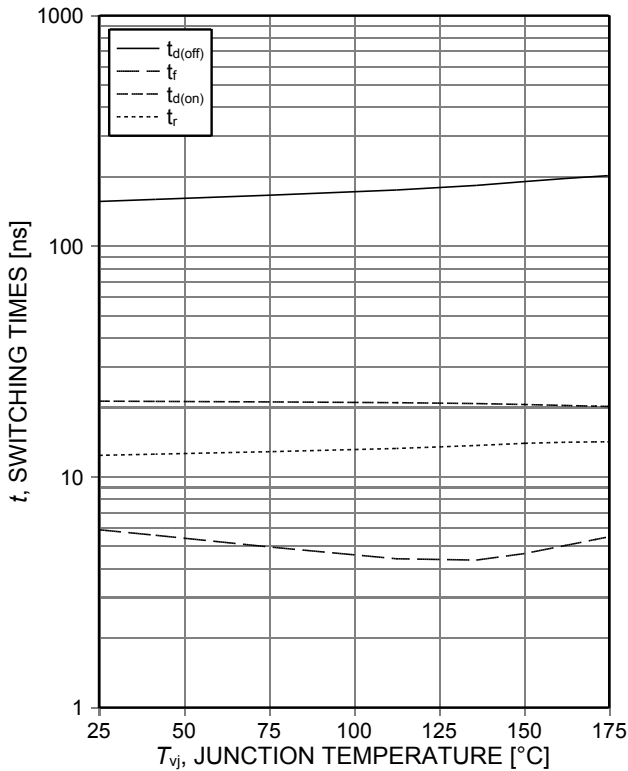

Figure 9. Typical switching times as a function of junction temperature (inductive load, $V_{CE}=400V$, $V_{GE}=0/15V$, $I_C=25A$, $R_{G(on)}=12\Omega$, $R_{G(off)}=12\Omega$, dynamic test circuit in Figure E)

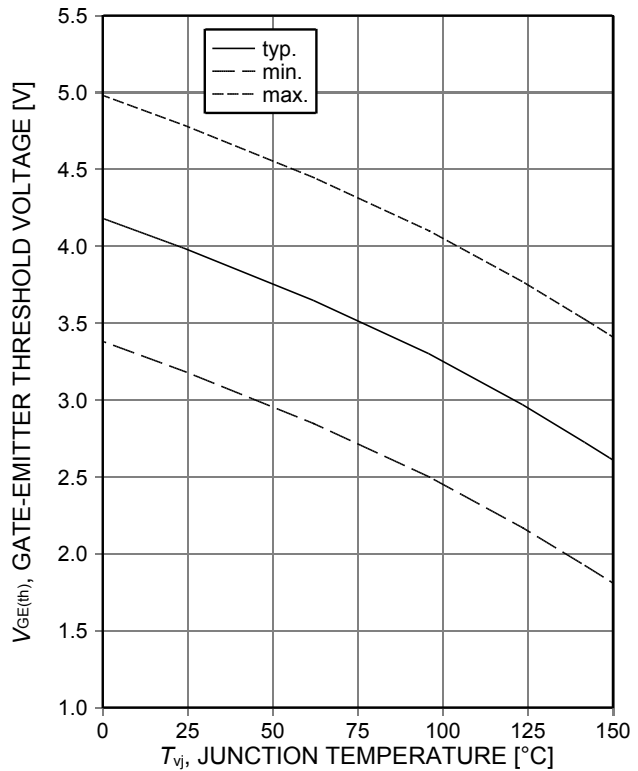

Figure 10. Gate-emitter threshold voltage as a function of junction temperature ($I_C=0.4mA$)

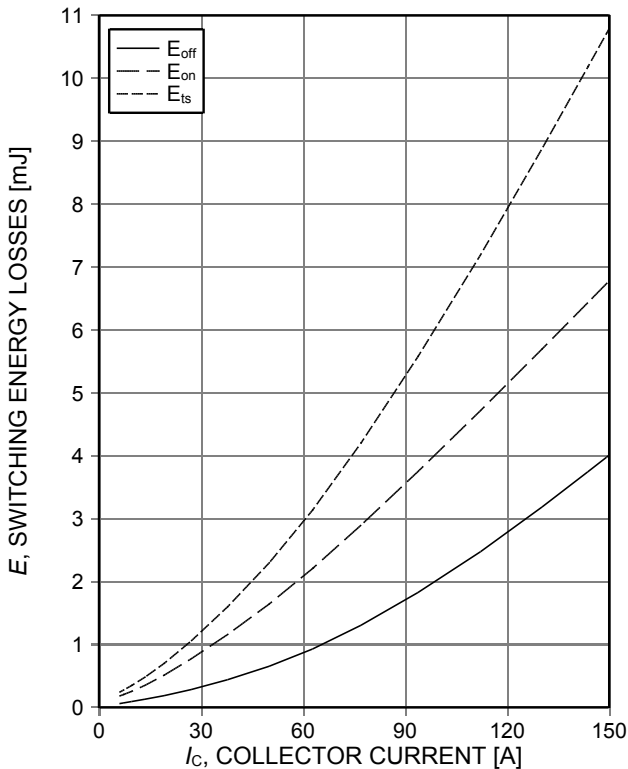

Figure 11. Typical switching energy losses as a function of collector current (inductive load, $T_{vj}=150^\circ C$, $V_{CE}=400V$, $V_{GE}=0/15V$, $R_{G(on)}=12\Omega$, $R_{G(off)}=12\Omega$, dynamic test circuit in Figure E)

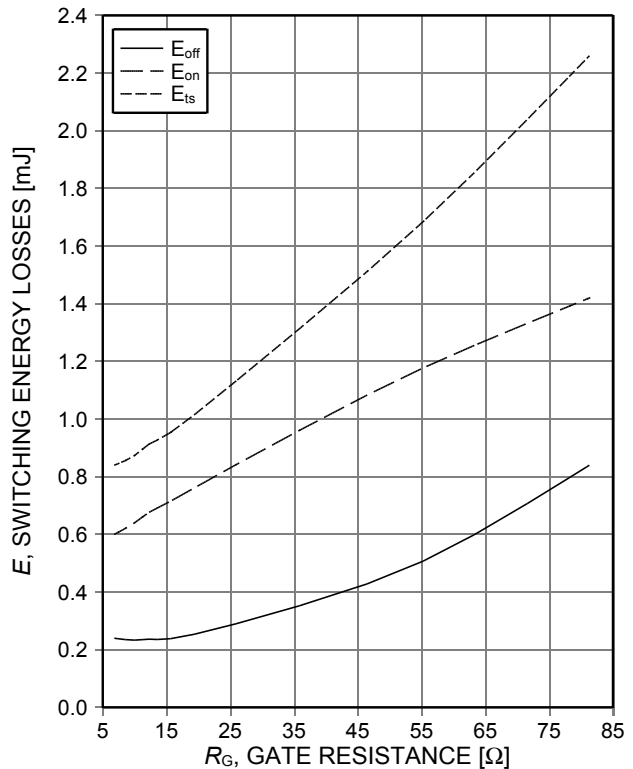

Figure 12. Typical switching energy losses as a function of gate resistance (inductive load, $T_{vj}=150^\circ C$, $V_{CE}=400V$, $V_{GE}=0/15V$, $I_C=25A$, dynamic test circuit in Figure E)

High speed switching series fifth generation

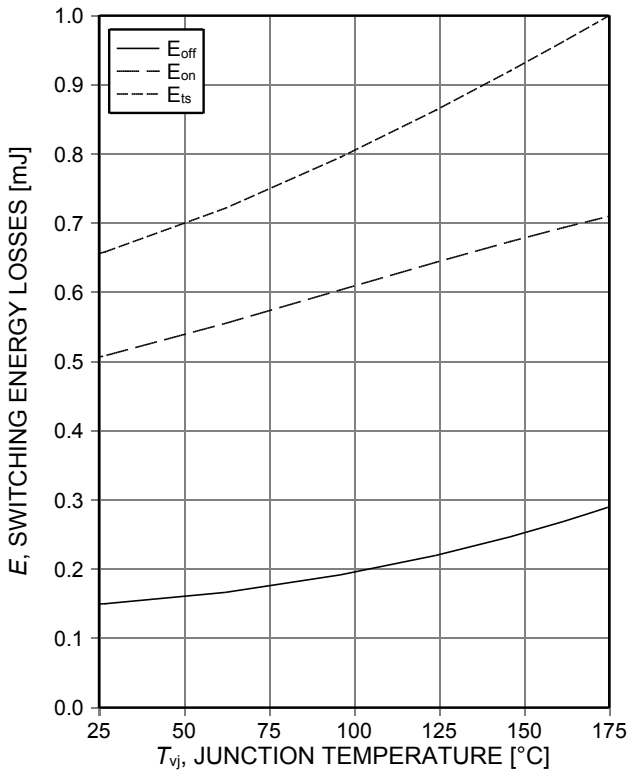

Figure 13. **Typical switching energy losses as a function of junction temperature** (inductive load, $V_{CE}=400V$, $V_{GE}=0/15V$, $I_C=25A$, $R_{G(on)}=12\Omega$, $R_{G(off)}=12\Omega$, dynamic test circuit in Figure E)

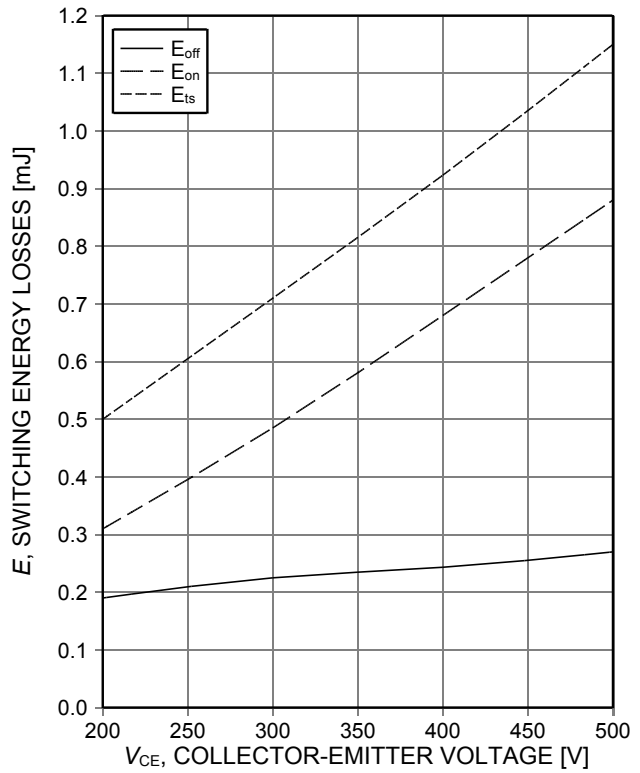

Figure 14. **Typical switching energy losses as a function of collector emitter voltage** (inductive load, $T_{vj}=150^\circ C$, $V_{GE}=0/15V$, $I_C=25A$, $R_{G(on)}=12\Omega$, $R_{G(off)}=12\Omega$, dynamic test circuit in Figure E)

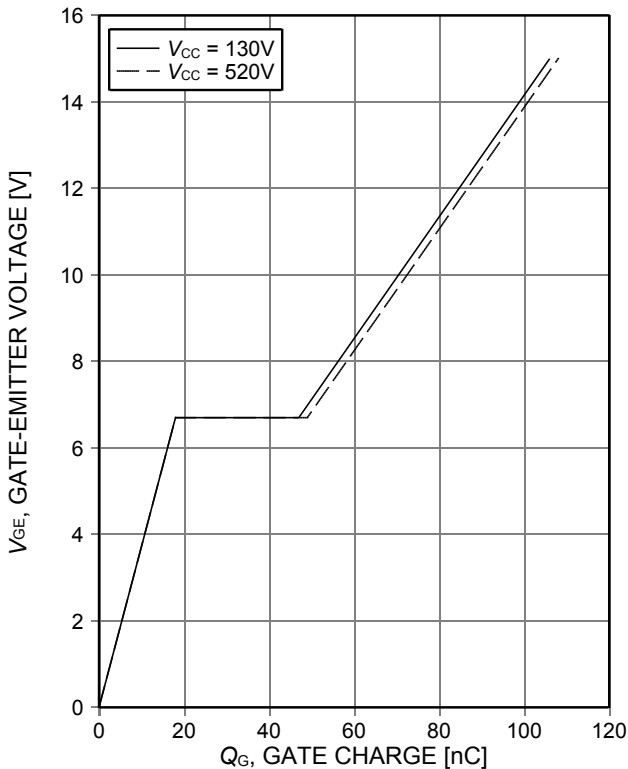

Figure 15. **Typical gate charge** ($I_C=50A$)

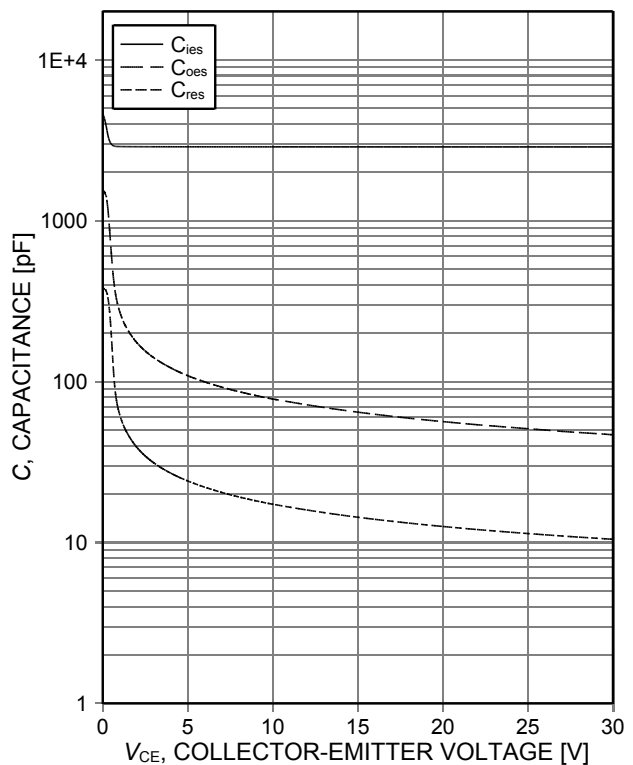

Figure 16. **Typical capacitance as a function of collector-emitter voltage** ($V_{GE}=0V$, $f=1MHz$)

High speed switching series fifth generation

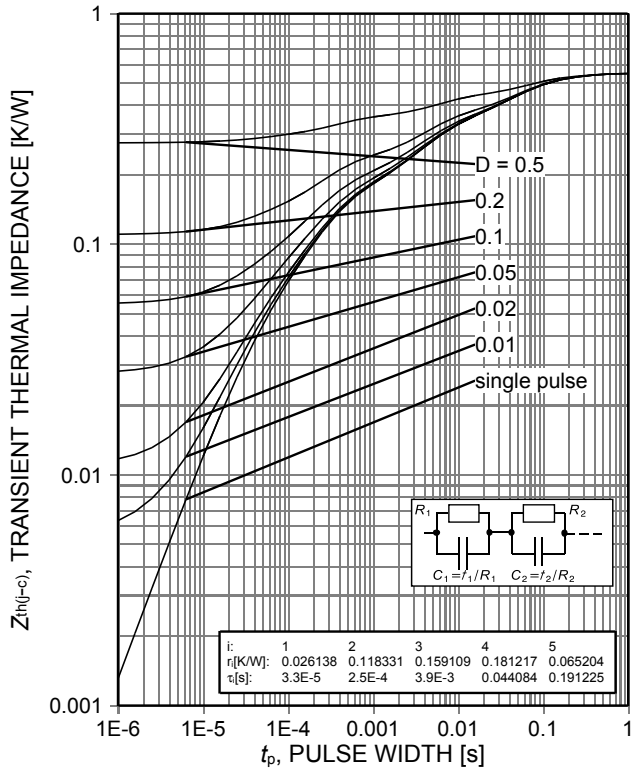
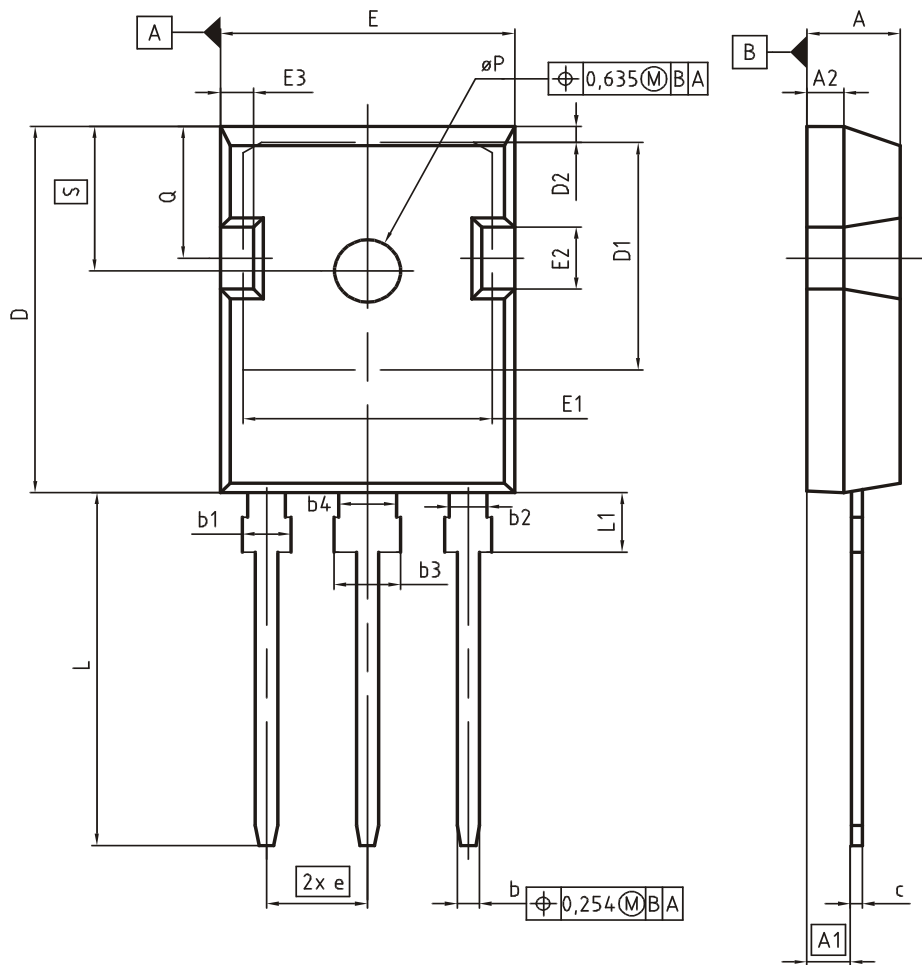

Figure 17. IGBT transient thermal impedance ($D=t_p/T$)

High speed switching series fifth generation

Package Drawing PG-TO247-3



DIM	MILLIMETERS		INCHES	
	MIN	MAX	MIN	MAX
A	4.83	5.21	0.190	0.205
A1	2.27	2.54	0.089	0.100
A2	1.85	2.16	0.073	0.085
b	1.07	1.33	0.042	0.052
b1	1.90	2.41	0.075	0.095
b2	1.90	2.16	0.075	0.085
b3	2.87	3.38	0.113	0.133
b4	2.87	3.13	0.113	0.123
c	0.55	0.68	0.022	0.027
D	20.80	21.10	0.819	0.831
D1	16.25	17.65	0.640	0.695
D2	0.95	1.35	0.037	0.053
E	15.70	16.13	0.618	0.635
E1	13.10	14.15	0.516	0.557
E2	3.68	5.10	0.145	0.201
E3	1.00	2.60	0.039	0.102
e	5.44 (BSC)		0.214 (BSC)	
N	3		3	
L	19.80	20.32	0.780	0.800
L1	4.10	4.47	0.161	0.176
øP	3.50	3.70	0.138	0.146
Q	5.49	6.00	0.216	0.236
S	6.04	6.30	0.238	0.248

DOCUMENT NO.
Z8B00003327

SCALE

EUROPEAN PROJECTION

ISSUE DATE
09-07-2010

REVISION
05

Testing Conditions



Figure A. Definition of switching times

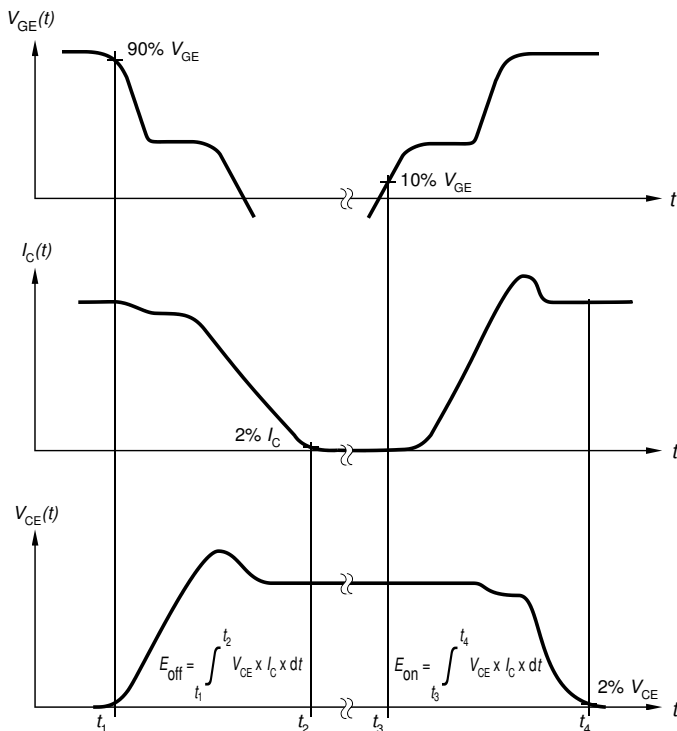

Figure B. Definition of switching losses



Figure C. Definition of diode switching characteristics



Figure D. Thermal equivalent circuit

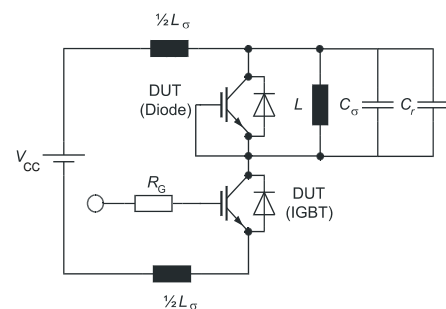

Figure E. Dynamic test circuit
Parasitic inductance L_{σ} ,
parasitic capacitor C_{σ} ,
relief capacitor C_r ,
(only for ZVT switching)



High speed switching series fifth generation

Revision History

AIGW50N65F5

Revision: 2017-06-27, Rev. 2.1

Previous Revision

Revision	Date	Subjects (major changes since last revision)
2.1	2017-06-27	Data sheet created

Trademarks of Infineon Technologies AG

μ HVIC™, μ IPM™, μ PFC™, AU-ConvertIR™, AURIX™, C166™, CanPAK™, CIPOS™, CIPURSE™, CoolDP™, CoolGaN™, COOLIR™, CoolMOS™, CoolSET™, CoolSiC™, DAVE™, DI-POL™, DirectFET™, DrBlade™, EasyPIM™, EconoBRIDGE™, EconoDUAL™, EconoPACK™, EconoPIM™, EiceDRIVER™, eupec™, FCOS™, GaNpowIR™, HEXFET™, HITFET™, HybridPACK™, iMOTION™, IRAM™, ISOFACE™, IsoPACK™, LEDriviR™, LITIX™, MIPAQ™, ModSTACK™, my-d™, NovalithIC™, OPTIGA™, OptiMOS™, ORIGA™, PowIRaudio™, PowIRstage™, PrimePACK™, PrimeSTACK™, PROFET™, PRO-SIL™, RASIC™, REAL3™, SmartLEWIS™, SOLID FLASH™, SPOC™, StrongIRFET™, SupIRBuck™, TEMPFET™, TRENCHSTOP™, TriCore™, UHVIC™, XHP™, XMC™

Trademarks updated November 2015

Other Trademarks

All referenced product or service names and trademarks are the property of their respective owners.

Published by
Infineon Technologies AG
81726 München, Germany
© Infineon Technologies AG 2017.
All Rights Reserved.

Important Notice

The information given in this document shall in no event be regarded as a guarantee of conditions or characteristics ("Beschaffenheitsgarantie"). With respect to any examples, hints or any typical values stated herein and/or any information regarding the application of the product, Infineon Technologies hereby disclaims any and all warranties and liabilities of any kind, including without limitation warranties of non-infringement of intellectual property rights of any third party.

In addition, any information given in this document is subject to customer's compliance with its obligations stated in this document and any applicable legal requirements, norms and standards concerning customer's products and any use of the product of Infineon Technologies in customer's applications.

The data contained in this document is exclusively intended for technically trained staff. It is the responsibility of customer's technical departments to evaluate the suitability of the product for the intended application and the completeness of the product information given in this document with respect to such application.

For further information on the product, technology, delivery terms and conditions and prices please contact your nearest Infineon Technologies office (www.infineon.com).

Warnings

Due to technical requirements products may contain dangerous substances. For information on the types in question please contact your nearest Infineon Technologies office.

Except as otherwise explicitly approved by Infineon Technologies in a written document signed by authorized representatives of Infineon Technologies, Infineon Technologies' products may not be used in any applications where a failure of the product or any consequences of the use thereof can reasonably be expected to result in personal injury.

单击下面可查看定价，库存，交付和生命周期等信息

[>>Infineon\(英飞凌\)](#)