

ESD106-B1-W0201

Bi-directional ESD protection device, 5.5 V, 0.13 pF, 0201



Product description

This Infineon ESD (electrostatic discharge) protection device has a bi-directional and symmetric I/V characteristic and excellent clamping performance.

Feature list

- ESD / transient protection according to:
 - IEC61000-4-2 (ESD): ± 15 kV (air) / ± 12 kV (contact)
 - IEC61000-4-4 (EFT): ± 1.5 kV / ± 30 A (5/50 ns)
 - IEC61000-4-5 (Surge): ± 1.5 A (8/20 μ s)
- Bi-directional maximum working voltage: $V_{WM} = \pm 5.5$ V
- Line capacitance: $C_L = 0.13$ pF at $f = 2.5$ GHz
- Clamping voltage: $V_{cl} = 25$ V at $I_{TLP} = 16$ A with $R_{dyn} = 1.1 \Omega$
- Very low leakage current: $I_L = 1$ nA
- Small form factor SMD size 0201, low profile (0.58 x 0.28 x 0.15 mm³)



Potential applications

Tailored for ESD protection and capacitance sensitive applications like:

- Super high speed interface
- RF antenna

Product validation

Qualified for industrial applications according to the relevant tests of JEDEC47/20/22.

Device information

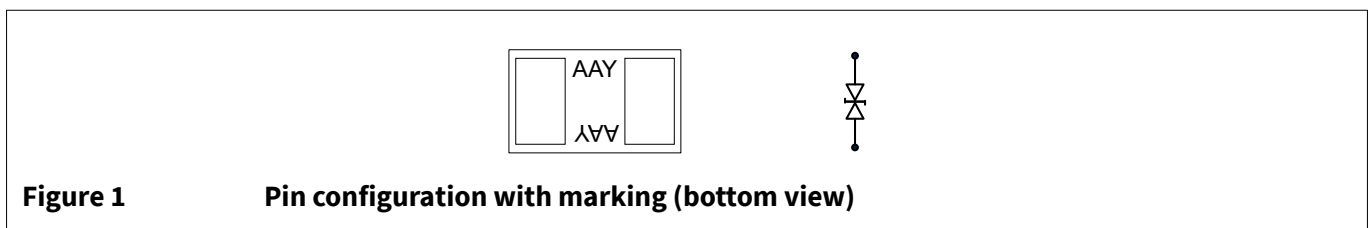

Table 1 Part information

Product name / Ordering code	Package	Pin configuration	Marking	Pieces / Reel
ESD106-B1-W0201 / ESD106B1W0201E6327XTSA1	WLL-2-3	1 line, bi-directional	AAY	15 k

Table of contents

	Product description	1
	Feature list	1
	Potential applications	1
	Product validation	1
	Device information	1
	Table of contents	2
1	Absolute maximum ratings	3
2	Electrical characteristics	4
3	Typical characteristic diagrams	6
4	Package information WLL-2-3	11
5	References	12
6	Revision history	12
	Disclaimer	13

1 Absolute maximum ratings

1 Absolute maximum ratings

Table 2 Absolute maximum ratings at $T_A = 25^\circ\text{C}$, unless otherwise specified

Parameter	Symbol	Values		Unit	Note or test condition
		Min.	Max.		
Working voltage	V_{WM}	-5.5	+5.5	V	
ESD discharge voltage	V_{ESD} (contact)	-12	+12	kV	Discharge network: $R = 330 \Omega$, $C = 150 \text{ pF}$ ¹⁾
	V_{ESD} (air)	-15	+15		
Peak pulse power	P_{PK}	-	15	W	Stress pulse: 8/20 μs current waveform ²⁾
Peak pulse current	I_{PP}	-1.5	+1.5	A	
Operating temperature	T_{op}	-55	+125	$^\circ\text{C}$	
Storage temperature	T_{stg}	-65	+150		

Attention: *Stresses above the maximum values listed here may cause permanent damage to the device. Exposure to absolute maximum rating conditions for extended periods may affect device reliability. Maximum ratings are absolute ratings. Exceeding only one of these values may cause irreversible damage to the component.*

¹ Based on IEC61000-4-2.

² Based on IEC61000-4-5.

2 Electrical characteristics

2 Electrical characteristics

Note: $T_A = 25^\circ\text{C}$, unless otherwise specified. Device is electrically symmetrical.

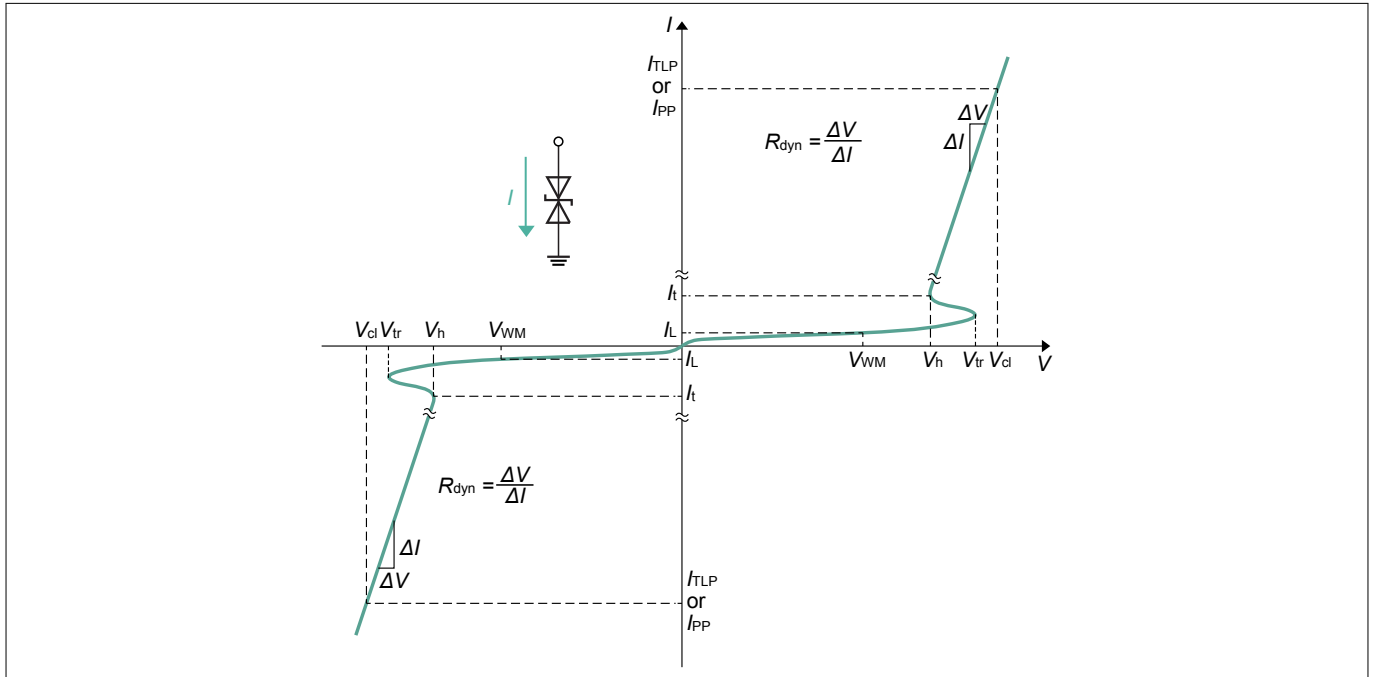

Figure 2 I/V characteristic curve

Table 3 I/V characteristic parameters

Symbol	Parameter
I_h	Holding current
I_L	Leakage current
I_{PP}	Peak pulse current, based on IEC61000-4-5
I_t	Test current
I_{TLP}	TLP current
R_{dyn}	Dynamic resistance
V_{cl}	Clamping voltage
V_h	Holding voltage
V_t	Test voltage
V_{tr}	Trigger voltage
V_{WM}	Maximum working voltage

2 Electrical characteristics

Table 4 DC characteristics

Parameter	Symbol	Values			Unit	Note or test condition
		Min.	Typ.	Max.		
Trigger voltage ³⁾	V_{tr}	6.1	9.5	-	V	
Holding voltage	V_h	6.1	7.5	9		$I_t = 1 \text{ mA}$
Leakage current	I_L	-	1	20	nA	$V_{WM} = 5.5 \text{ V}$

Table 5 AC characteristics

Parameter	Symbol	Values			Unit	Note or test condition
		Min.	Typ.	Max.		
Line capacitance	C_L	-	-	0.25	pF	$V = 0 \text{ V}, f = 1 \text{ MHz}$
		-	0.13	-		$V = 0 \text{ V}, f = 2.5 \text{ GHz}$
Series inductance	L_S	-	<0.1	-	nH	Extracted from S-parameters

Table 6 Protection characteristics

Parameter	Symbol	Values			Unit	Note or test condition
		Min.	Typ.	Max.		
Clamping voltage (TLP) ^{4) 5)}	V_{cl}	-	12.2	-	V	$I_{TLP} = 4 \text{ A}$
		-	16	-		$I_{TLP} = 8 \text{ A}$
		-	25	-		$I_{TLP} = 16 \text{ A}$
Clamping voltage (8/20 μs) ⁶⁾		-	8.5	-		$I_{PP} = 1 \text{ A}$
		-	10	-		$I_{PP} = 1.5 \text{ A}$
Dynamic resistance ⁴⁾	R_{dyn}	-	1.1	-	Ω	

³ Verified by design.

⁴ TLP parameters: $Z_0 = 50 \Omega$, $t_p = 100 \text{ ns}$, $t_r = 0.6 \text{ ns}$, averaging window 30-60 ns.

⁵ Refer to application note AN210 [\[2\]](#)

⁶ $t_p = 8/20 \mu\text{s}$. Stress pulse based on IEC61000-4-5.

3 Typical characteristic diagrams

3 Typical characteristic diagrams

Note: $T_A = 25\text{ }^\circ\text{C}$, unless otherwise specified.

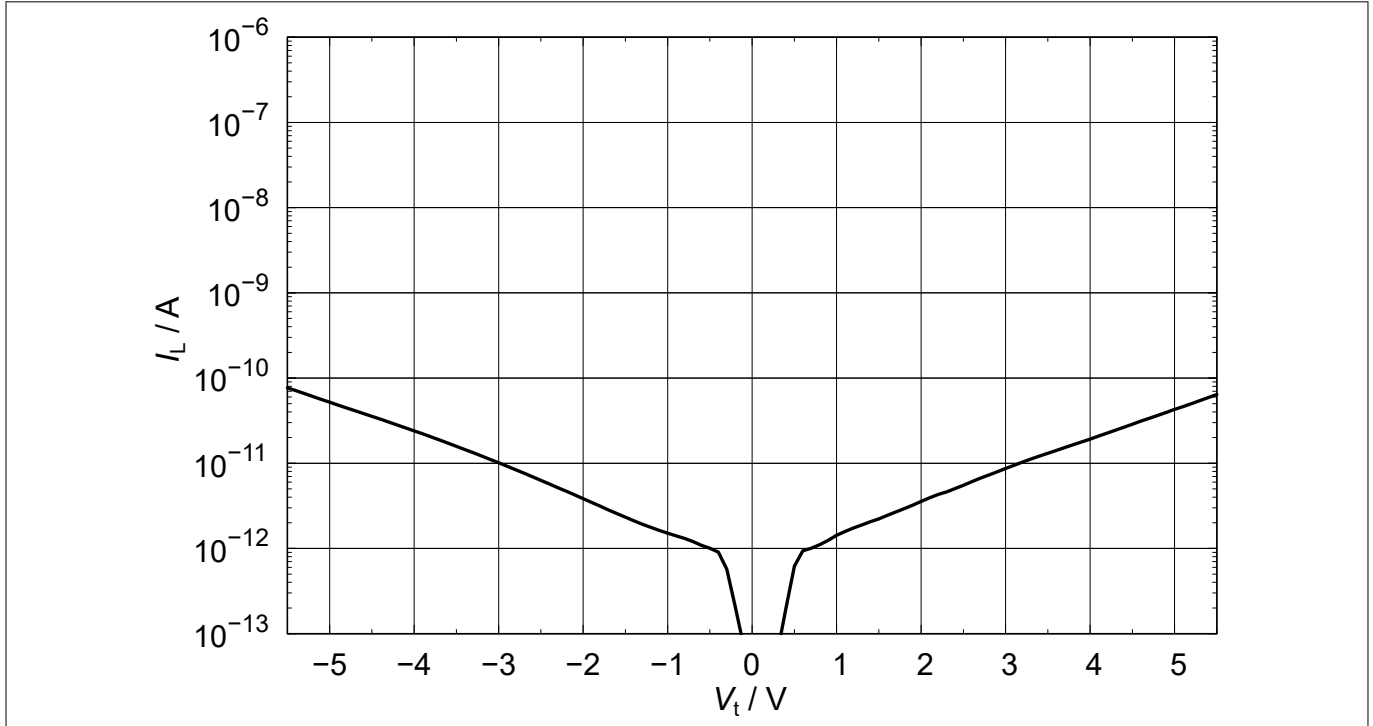

Figure 3 Leakage current: $I_L = f(V_t)$

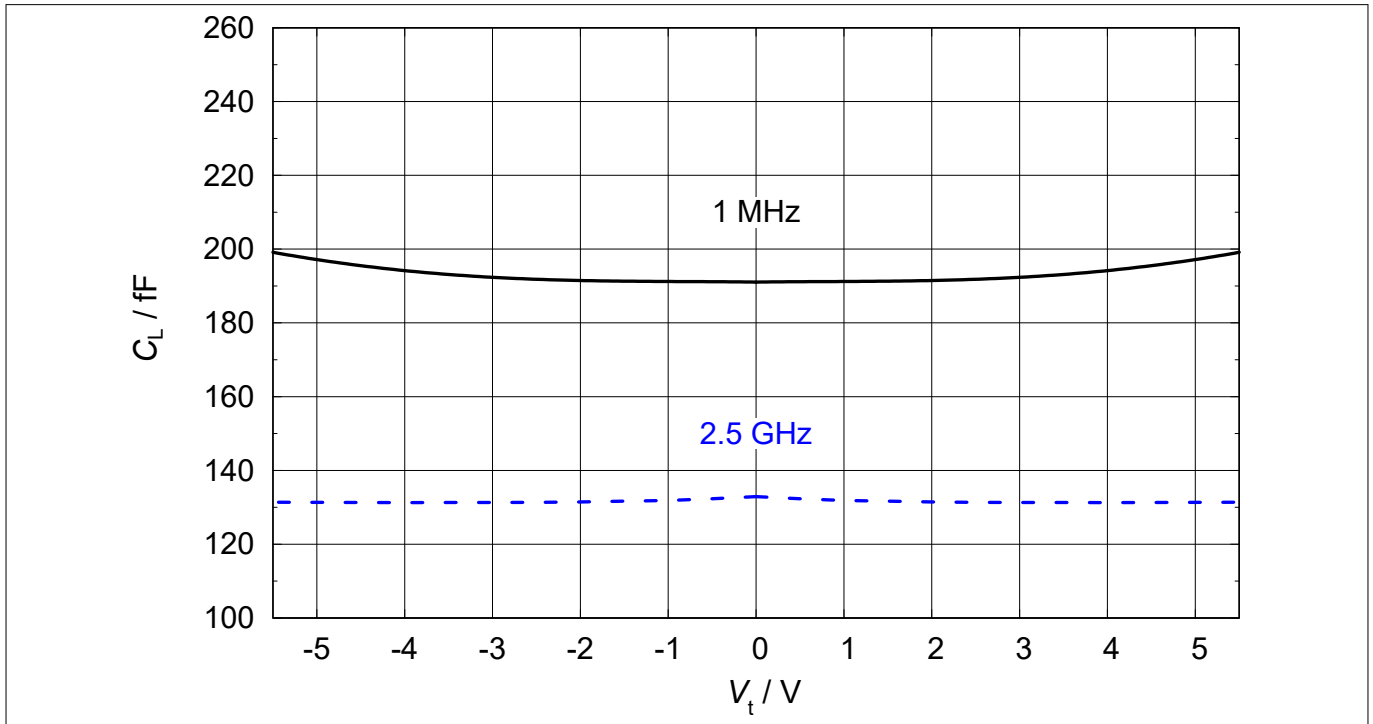

Figure 4 Line capacitance: $C_L = f(V_t)$, $f = 1\text{ MHz}, 2.5\text{ GHz}$

3 Typical characteristic diagrams

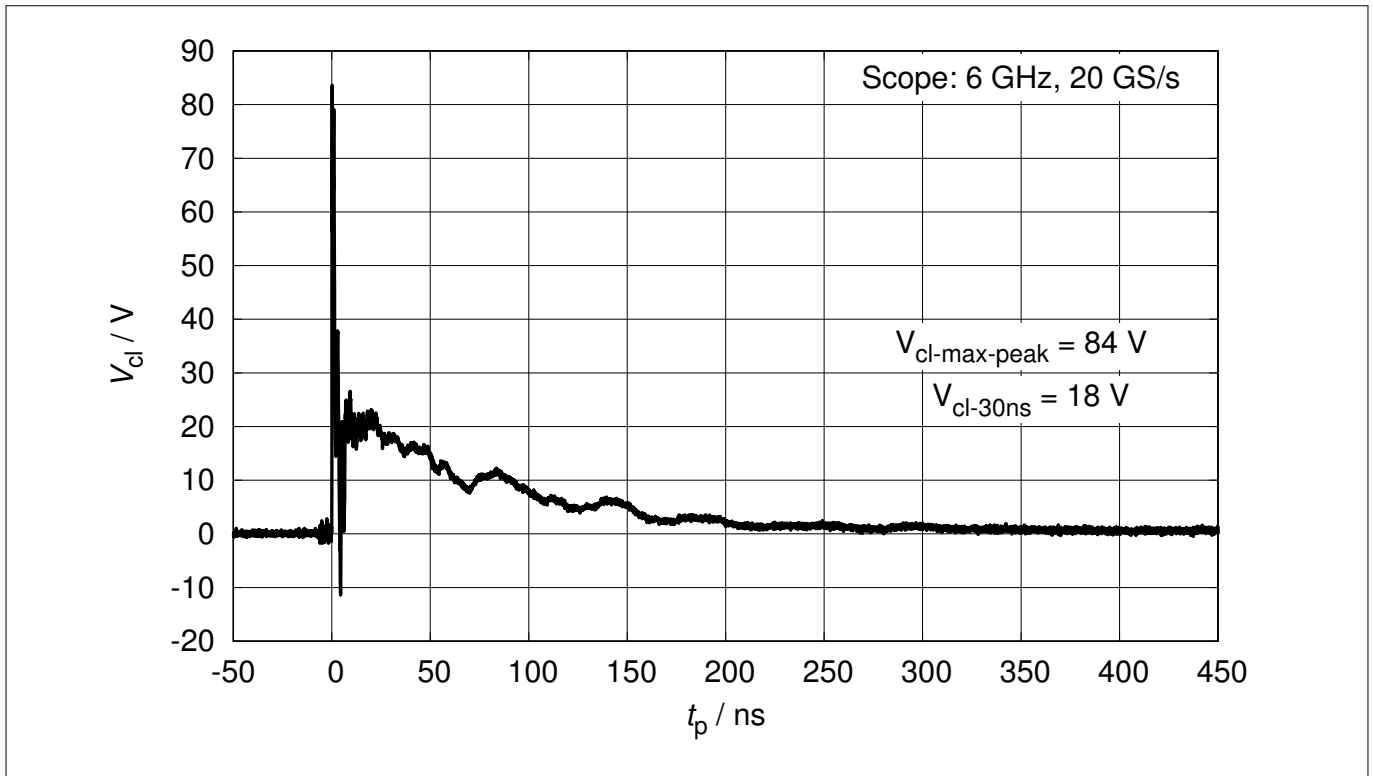

Figure 5 Clamping voltage (ESD): $V_{cl} = f(t_p)$, 8 kV positive pulse based on IEC61000-4-2

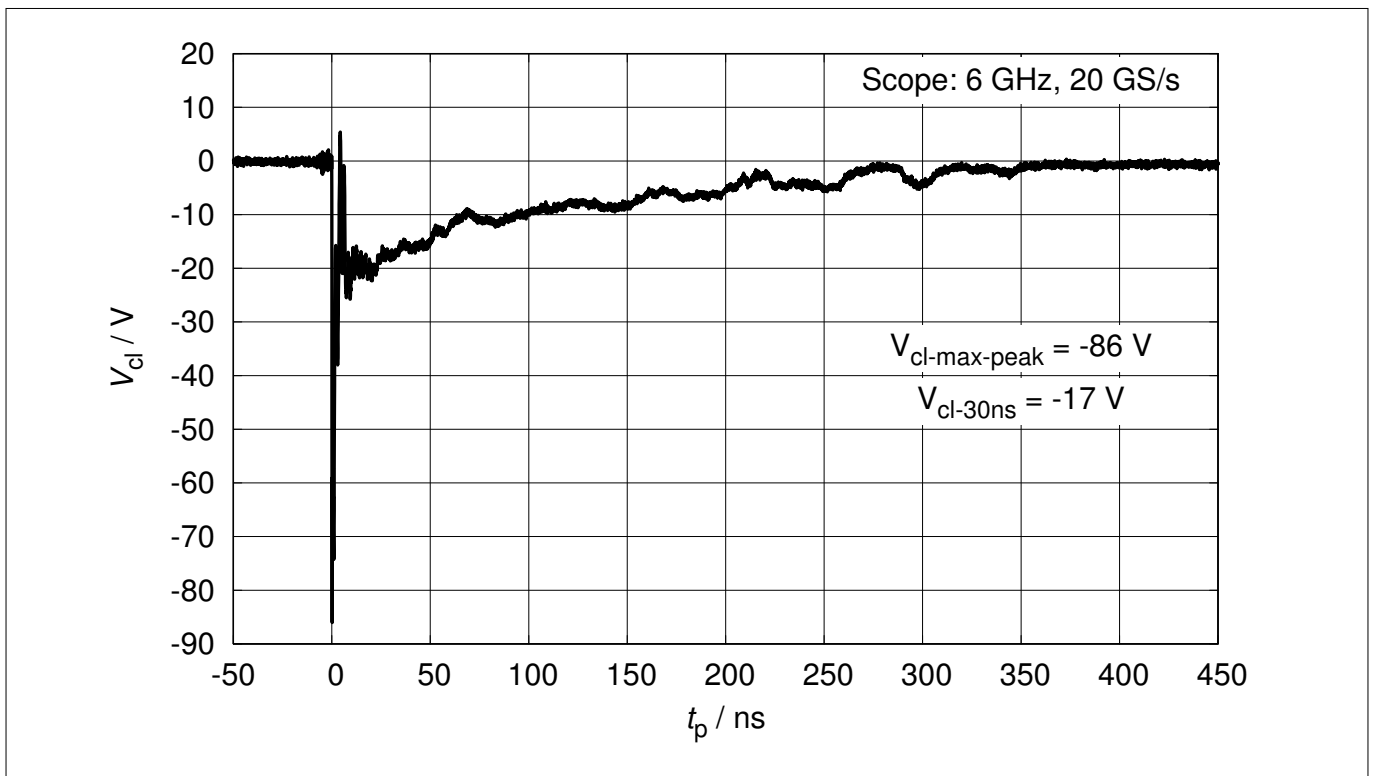

Figure 6 Clamping voltage (ESD): $V_{cl} = f(t_p)$, 8 kV negative pulse based on IEC61000-4-2

3 Typical characteristic diagrams

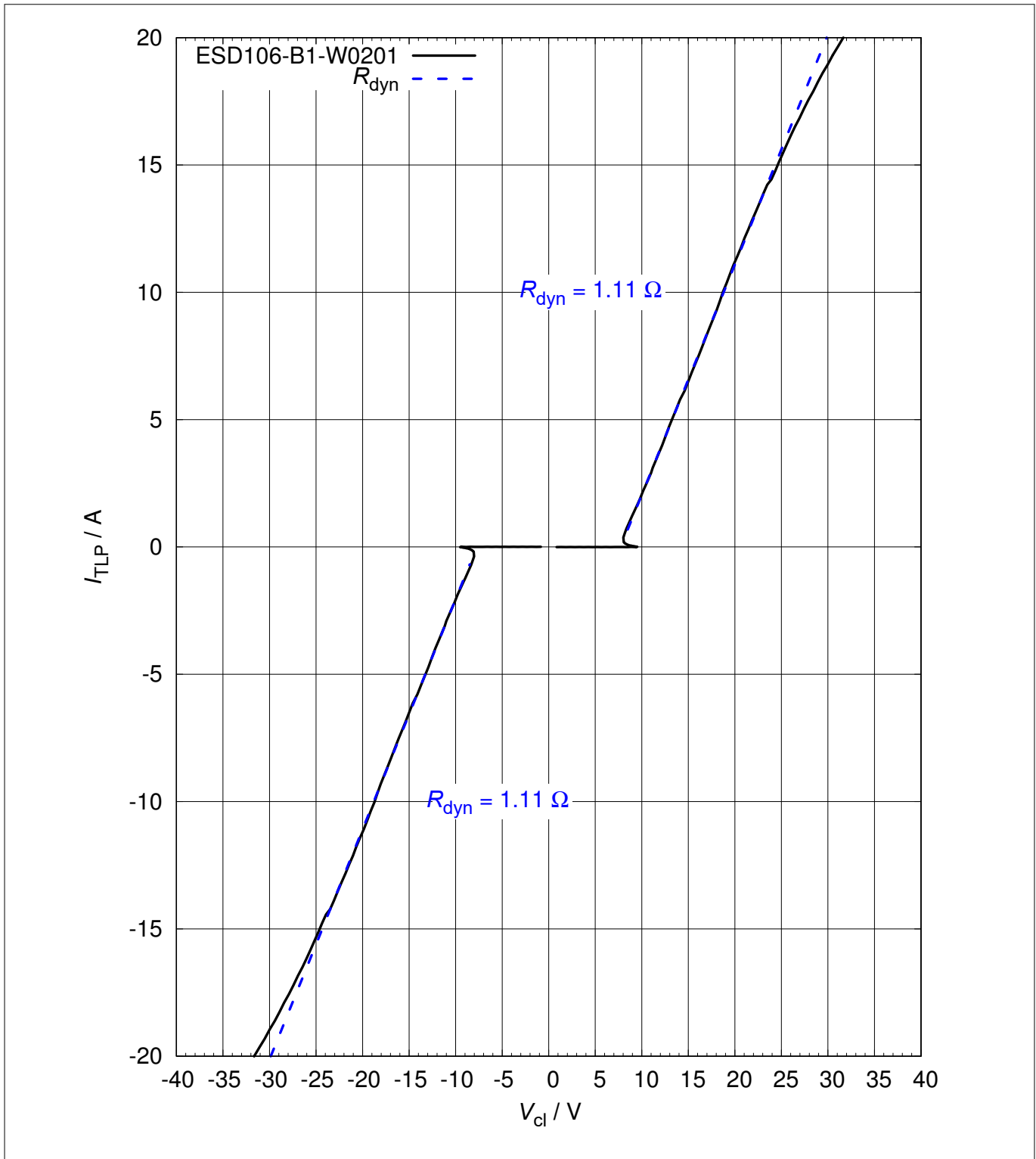

Figure 7 Clamping voltage (TLP): $I_{TLP} = f(V_{cl})$

3 Typical characteristic diagrams

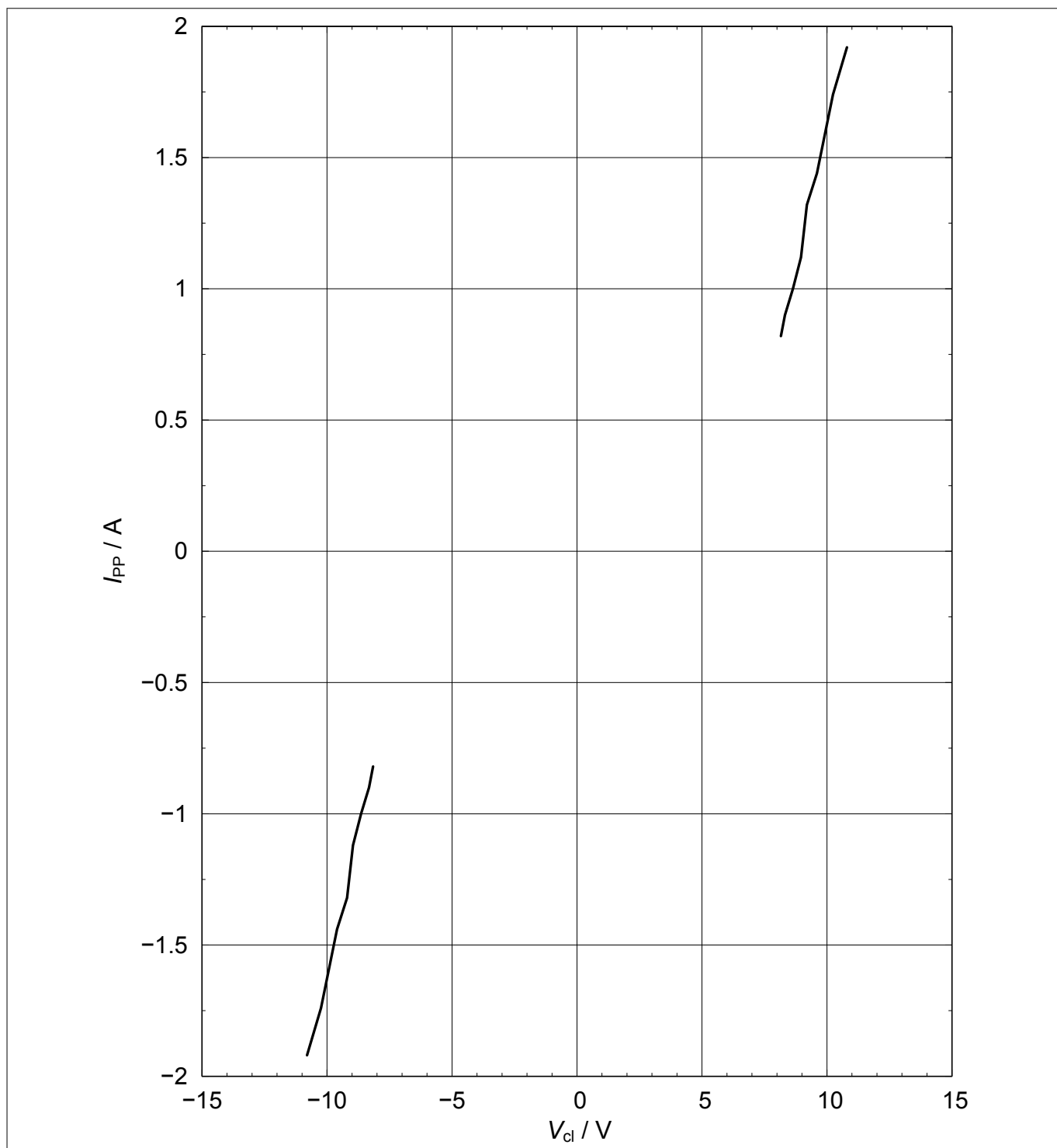

Figure 8 Clamping voltage (Surge): $I_{PP} = f(V_{cl})$, based on IEC61000-4-5

3 Typical characteristic diagrams

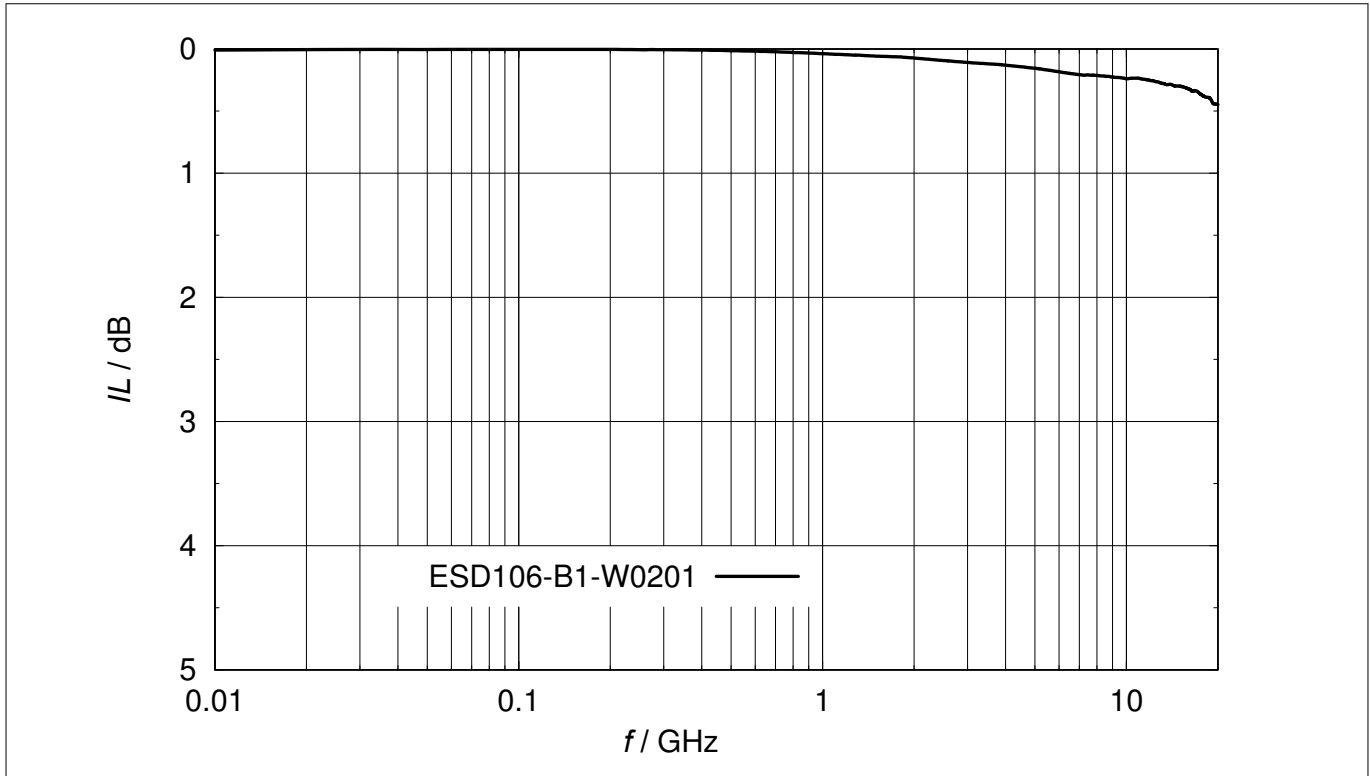

Figure 9 Insertion loss $IL = f(f)$, measured in a 50 Ω system

4 Package information WLL-2-3

4 Package information WLL-2-3

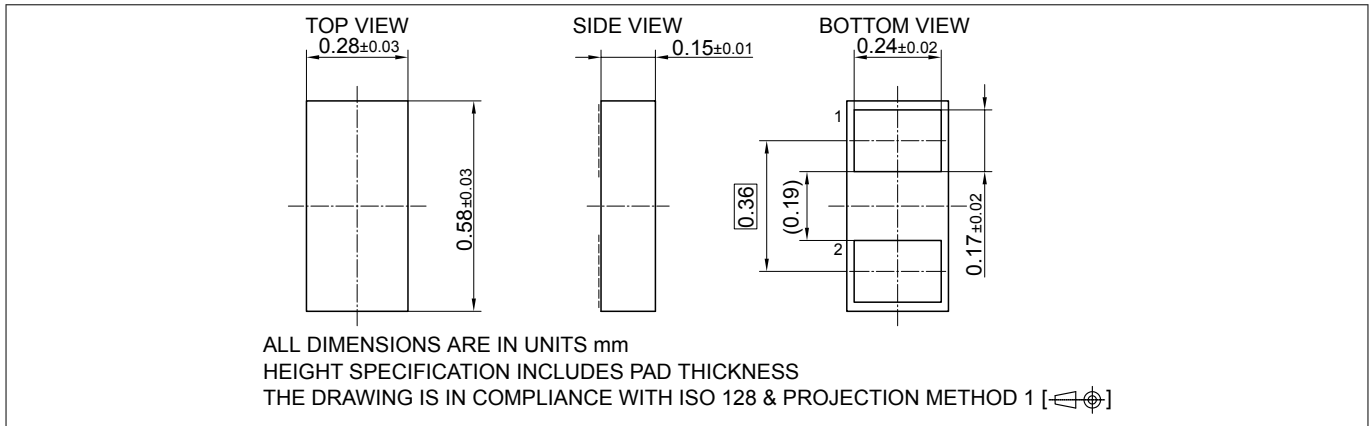

Figure 10 WLL-2-3 package

Note: For package information including footprint, packing and assembly recommendation refer to:

<https://www.infineon.com/packages/SG-WLL-2-3/>

5 References

5 References

[1]	Infineon AG - Understanding ESD protection device characteristics
[2]	Infineon AG - Application note AN210 : Effective ESD Protection Design at System Level Using VF-TLP Characterization Methodology

6 Revision history

Document version	Date of release	Description of changes
1.0	2018-09-19	<ul style="list-style-type: none">• VESD (air) value updated
1.1	2018-09-21	<ul style="list-style-type: none">• CL diagram updated
2.0	2019-08-09	<ul style="list-style-type: none">• New datasheet layout, values updated
2.1	2020-06-22	<ul style="list-style-type: none">• Datasheet layout update

Trademarks

All referenced product or service names and trademarks are the property of their respective owners.

Edition 2020-06-22

Published by
Infineon Technologies AG
81726 Munich, Germany

© 2020 Infineon Technologies AG
All Rights Reserved.

Do you have a question about any
aspect of this document?
Email: erratum@infineon.com

Document reference
IFX-rlz1584369202658

IMPORTANT NOTICE

The information given in this document shall in no event be regarded as a guarantee of conditions or characteristics ("Beschaffheitsgarantie").

With respect to any examples, hints or any typical values stated herein and/or any information regarding the application of the product, Infineon Technologies hereby disclaims any and all warranties and liabilities of any kind, including without limitation warranties of non-infringement of intellectual property rights of any third party.

In addition, any information given in this document is subject to customer's compliance with its obligations stated in this document and any applicable legal requirements, norms and standards concerning customer's products and any use of the product of Infineon Technologies in customer's applications.

The data contained in this document is exclusively intended for technically trained staff. It is the responsibility of customer's technical departments to evaluate the suitability of the product for the intended application and the completeness of the product information given in this document with respect to such application.

WARNINGS

Due to technical requirements products may contain dangerous substances. For information on the types in question please contact your nearest Infineon Technologies office.

Except as otherwise explicitly approved by Infineon Technologies in a written document signed by authorized representatives of Infineon Technologies, Infineon Technologies' products may not be used in any applications where a failure of the product or any consequences of the use thereof can reasonably be expected to result in personal injury.

单击下面可查看定价，库存，交付和生命周期等信息

[>>Infineon\(英飞凌\)](#)