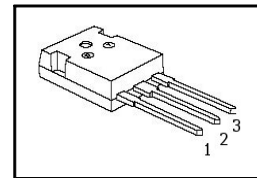

CoolMOS™ Power Transistor
Features

- Lowest figure-of-merit $R_{ON} \times Q_g$
- Extreme dv/dt rated
- High peak current capability
- Qualified for industrial grade applications according to JEDEC¹⁾
- Pb-free lead plating; RoHS compliant
- Ultra low gate charge

Product Summary

| | | |
|----------------------|-------|----------|
| $V_{DS} @ T_{j,max}$ | 650 | V |
| $R_{DS(on),max}$ | 0.075 | Ω |
| $Q_{g,typ}$ | 87 | nC |

PG-TO247-3

CoolMOS CP is designed for:

- Hard switching SMPS topologies for Server and Telecom

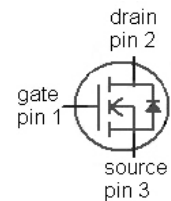
| Type | Package | Marking |
|-------------|------------|---------|
| IPW60R075CP | PG-TO247-3 | 6R075P |

Maximum ratings, at $T_j=25\text{ °C}$, unless otherwise specified

| Parameter | Symbol | Conditions | Value | Unit |
|---|----------------|---------------------------------------|-------------|--------------------|
| Continuous drain current | I_D | $T_C=25\text{ °C}$ | 39 | A |
| | | $T_C=100\text{ °C}$ | 25 | |
| Pulsed drain current ²⁾ | $I_{D,pulse}$ | $T_C=25\text{ °C}$ | 130 | |
| Avalanche energy, single pulse | E_{AS} | $I_D=11\text{ A}, V_{DD}=50\text{ V}$ | 1150 | mJ |
| Avalanche energy, repetitive t_{AR} ^{2),3)} | E_{AR} | $I_D=11\text{ A}, V_{DD}=50\text{ V}$ | 1.7 | |
| Avalanche current, repetitive t_{AR} ^{2),3)} | I_{AR} | | 11 | A |
| MOSFET dv/dt ruggedness | dv/dt | $V_{DS}=0\dots 480\text{ V}$ | 50 | V/ns |
| Gate source voltage | V_{GS} | static | ± 20 | V |
| | | AC ($f > 1\text{ Hz}$) | ± 30 | |
| Power dissipation | P_{tot} | $T_C=25\text{ °C}$ | 313 | W |
| Operating and storage temperature | T_j, T_{stg} | | -55 ... 150 | $^{\circ}\text{C}$ |
| Mounting torque | | M3 and M3.5 screws | 60 | Ncm |

Maximum ratings, at $T_j=25\text{ °C}$, unless otherwise specified

| Parameter | Symbol | Conditions | Value | Unit |
|-------------------------------------|---------------|--------------------|-------|------|
| Continuous diode forward current | I_S | $T_C=25\text{ °C}$ | 26 | A |
| Diode pulse current ²⁾ | $I_{S,pulse}$ | | 117 | |
| Reverse diode dv/dt ⁴⁾ | dv/dt | | 15 | V/ns |

| Parameter | Symbol | Conditions | Values | | | Unit |
|-----------|--------|------------|--------|------|------|------|
| | | | min. | typ. | max. | |

Thermal characteristics

| | | | | | | |
|--|------------|---------------------------------------|---|---|-----|-----|
| Thermal resistance, junction - case | R_{thJC} | | - | - | 0.4 | K/W |
| Thermal resistance, junction - ambient | R_{thJA} | leaded | - | - | 62 | |
| Soldering temperature, wavesoldering only allowed at leads | T_{sold} | 1.6 mm (0.063 in.) from case for 10 s | - | - | 260 | °C |

Electrical characteristics, at $T_j=25\text{ °C}$, unless otherwise specified

Static characteristics

| | | | | | | |
|----------------------------------|---------------|---|-----|-------|-------|---------------|
| Drain-source breakdown voltage | $V_{(BR)DSS}$ | $V_{GS}=0\text{ V}, I_D=250\text{ }\mu\text{A}$ | 600 | - | - | V |
| Gate threshold voltage | $V_{GS(th)}$ | $V_{DS}=V_{GS}, I_D=1.7\text{ mA}$ | 2.5 | 3 | 3.5 | |
| Zero gate voltage drain current | I_{DSS} | $V_{DS}=600\text{ V}, V_{GS}=0\text{ V}, T_j=25\text{ °C}$ | - | - | 5 | μA |
| | | $V_{DS}=600\text{ V}, V_{GS}=0\text{ V}, T_j=150\text{ °C}$ | - | 50 | - | |
| Gate-source leakage current | I_{GSS} | $V_{GS}=20\text{ V}, V_{DS}=0\text{ V}$ | - | - | 100 | nA |
| Drain-source on-state resistance | $R_{DS(on)}$ | $V_{GS}=10\text{ V}, I_D=26\text{ A}, T_j=25\text{ °C}$ | - | 0.068 | 0.075 | Ω |
| | | $V_{GS}=10\text{ V}, I_D=26\text{ A}, T_j=150\text{ °C}$ | - | 0.18 | - | |
| Gate resistance | R_G | $f=1\text{ MHz}$, open drain | - | 1.3 | - | Ω |

| Parameter | Symbol | Conditions | Values | | | Unit |
|-----------|--------|------------|--------|------|------|------|
| | | | min. | typ. | max. | |

Dynamic characteristics

| | | | | | | |
|--|--------------|---|---|------|---|----|
| Input capacitance | C_{iss} | $V_{GS}=0\text{ V}, V_{DS}=100\text{ V},$ $f=1\text{ MHz}$ | - | 4000 | - | pF |
| Output capacitance | C_{oss} | | - | 190 | - | |
| Effective output capacitance, energy related ⁵⁾ | $C_{o(er)}$ | $V_{GS}=0\text{ V}, V_{DS}=0\text{ V}$ to 480 V | - | 180 | - | |
| Effective output capacitance, time related ⁶⁾ | $C_{o(tr)}$ | | - | 480 | - | |
| Turn-on delay time | $t_{d(on)}$ | $V_{DD}=400\text{ V},$ $V_{GS}=10\text{ V}, I_D=26\text{ A},$ $R_G=7.6\ \Omega$ | - | 40 | - | ns |
| Rise time | t_r | | - | 17 | - | |
| Turn-off delay time | $t_{d(off)}$ | | - | 110 | - | |
| Fall time | t_f | | - | 7 | - | |

Gate Charge Characteristics

| | | | | | | |
|-----------------------|---------------|---|---|-----|-----|----|
| Gate to source charge | Q_{gs} | $V_{DD}=400\text{ V}, I_D=26\text{ A},$ $V_{GS}=0\text{ to }10\text{ V}$ | - | 20 | - | nC |
| Gate to drain charge | Q_{gd} | | - | 30 | - | |
| Gate charge total | Q_g | | - | 87 | 116 | |
| Gate plateau voltage | $V_{plateau}$ | | - | 5.0 | - | V |

Reverse Diode

| | | | | | | |
|-------------------------------|-----------|---|---|-----|-----|---------------|
| Diode forward voltage | V_{SD} | $V_{GS}=0\text{ V}, I_F=26\text{ A},$ $T_j=25\text{ }^\circ\text{C}$ | - | 0.9 | 1.2 | V |
| Reverse recovery time | t_{rr} | $V_R=400\text{ V}, I_F=I_S,$ $di_F/dt=100\text{ A}/\mu\text{s}$ | - | 500 | - | ns |
| Reverse recovery charge | Q_{rr} | | - | 15 | - | μC |
| Peak reverse recovery current | I_{rrm} | | - | 58 | - | A |

¹⁾ J-STD20 and JESD22

²⁾ Pulse width t_p limited by $T_{j,max}$

³⁾ Repetitive avalanche causes additional power losses that can be calculated as $P_{AV}=E_{AR} \cdot f$.

⁴⁾ $I_{SD} \leq I_D$, $di/dt \leq 100\text{ A}/\mu\text{s}$, $V_{DClink}=400\text{ V}$, $V_{peak} < V_{(BR)DSS}$, $T_j < T_{j,max}$, identical low side and high side switch

⁵⁾ $C_{o(er)}$ is a fixed capacitance that gives the same stored energy as C_{oss} while V_{DS} is rising from 0 to 80% V_{DSS} .

⁶⁾ $C_{o(tr)}$ is a fixed capacitance that gives the same charging time as C_{oss} while V_{DS} is rising from 0 to 80% V_{DSS} .

1 Power dissipation

$P_{tot}=f(T_C)$

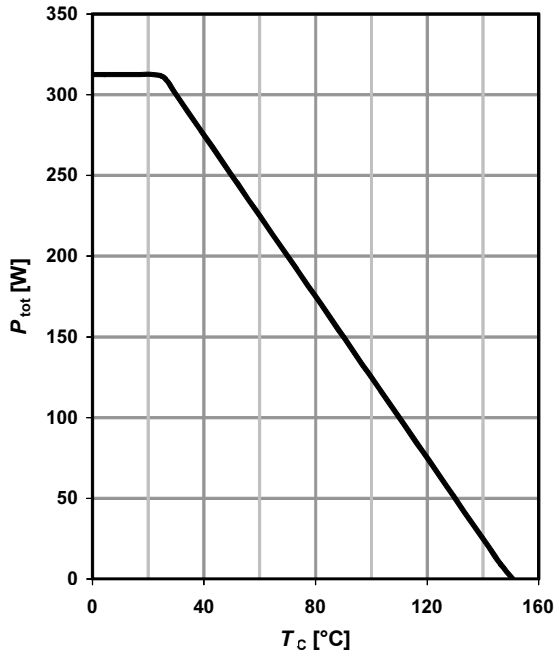

2 Safe operating area

$I_D=f(V_{DS}); T_C=25\text{ °C}; D=0$

parameter: t_p

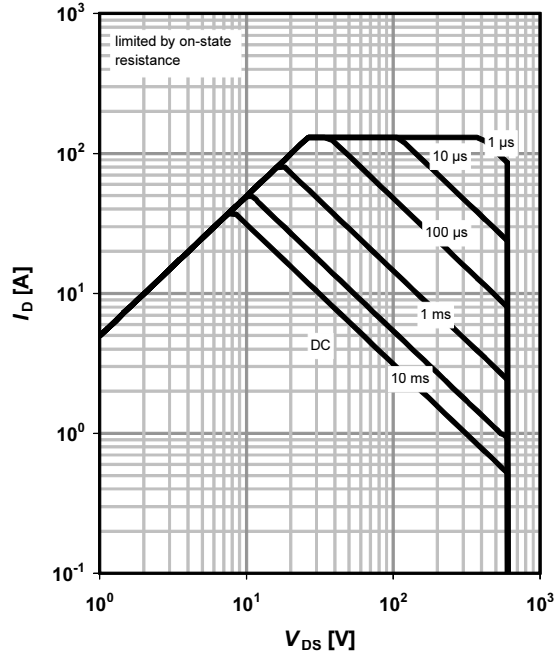

3 Max. transient thermal impedance

$Z_{thJC}=f(t_p)$

parameter: $D=t_p/T$

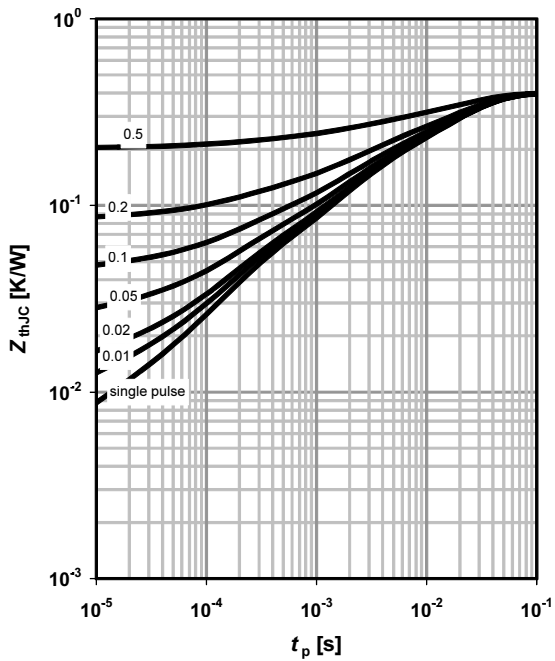

4 Typ. output characteristics

$I_D=f(V_{DS}); T_J=25\text{ °C}$

parameter: V_{GS}

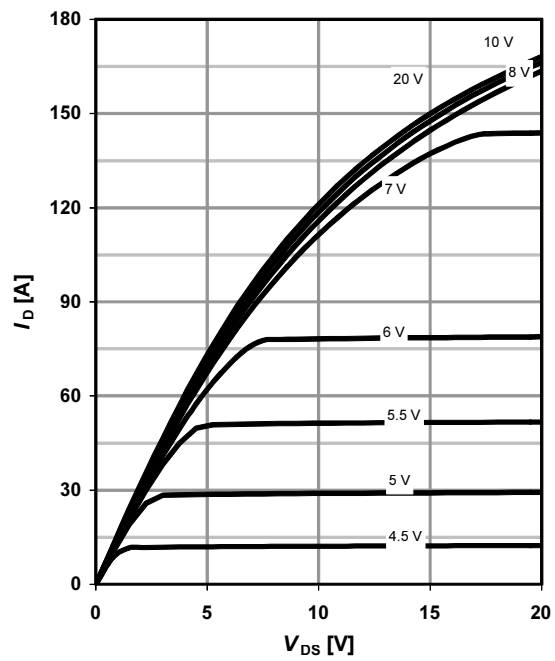

5 Typ. output characteristics

$I_D = f(V_{DS}); T_j = 150\text{ }^\circ\text{C}$

parameter: V_{GS}

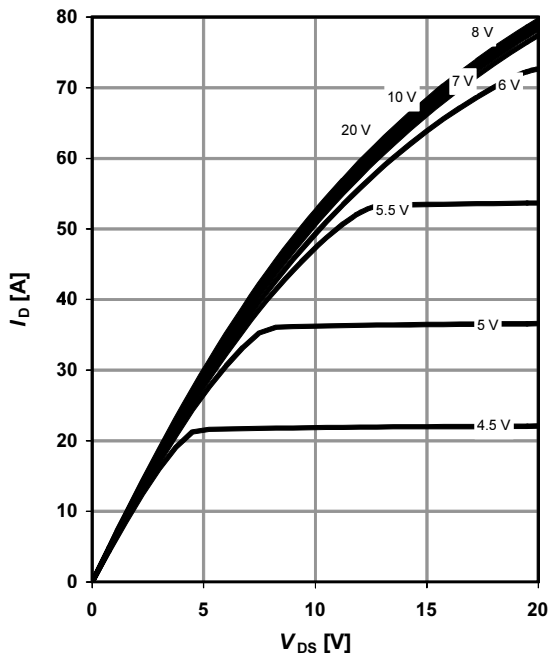

6 Typ. drain-source on-state resistance

$R_{DS(on)} = f(I_D); T_j = 150\text{ }^\circ\text{C}$

parameter: V_{GS}

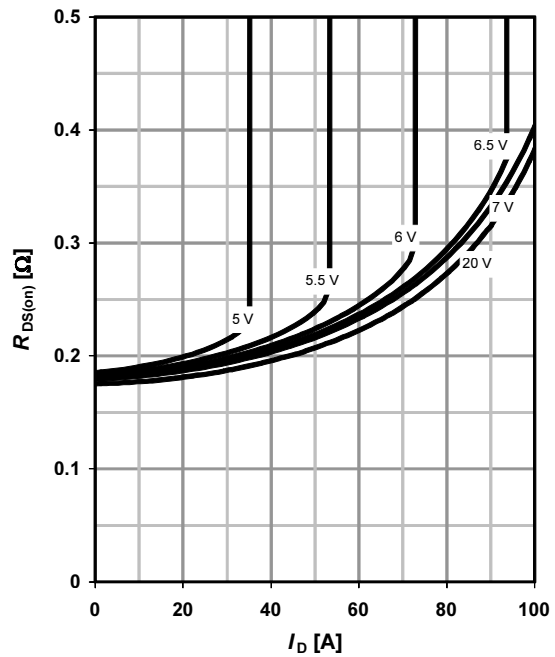

7 Drain-source on-state resistance

$R_{DS(on)} = f(T_j); I_D = 26\text{ A}; V_{GS} = 10\text{ V}$

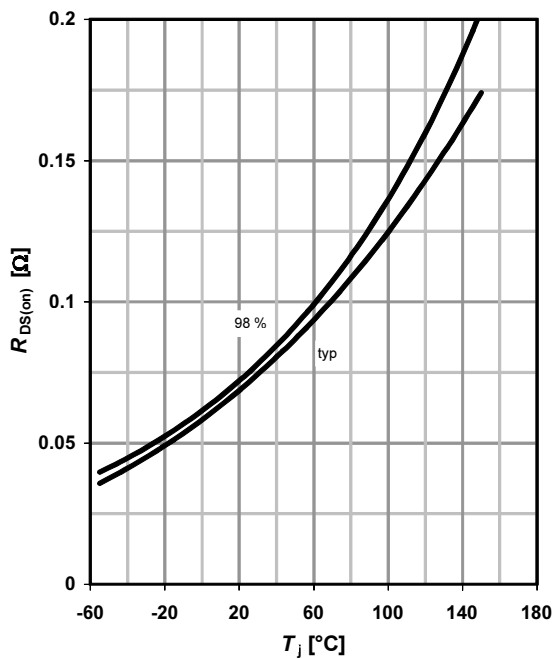

8 Typ. transfer characteristics

$I_D = f(V_{GS}); |V_{DS}| > 2|I_D|R_{DS(on)max}$

parameter: T_j

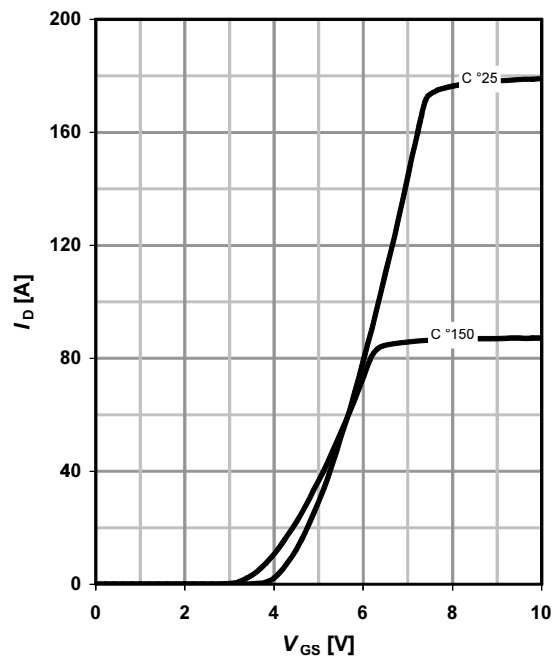

9 Typ. gate charge

$V_{GS}=f(Q_{gate}); I_D=26\text{ A pulsed}$

parameter: V_{DD}

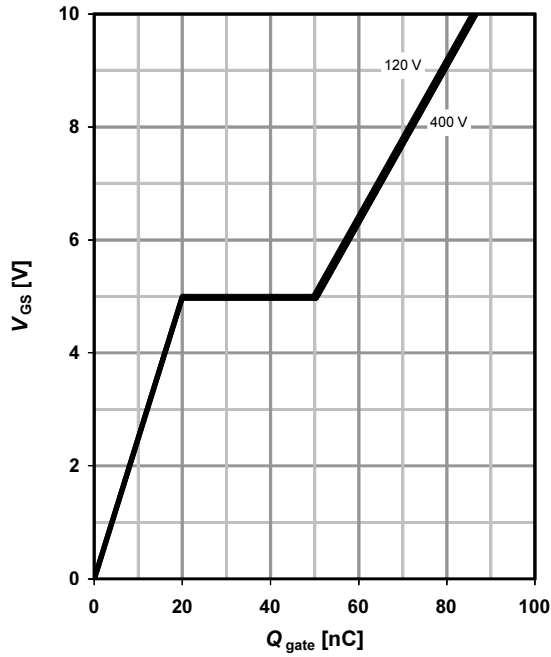

10 Forward characteristics of reverse diode

$I_F=f(V_{SD})$

parameter: T_j

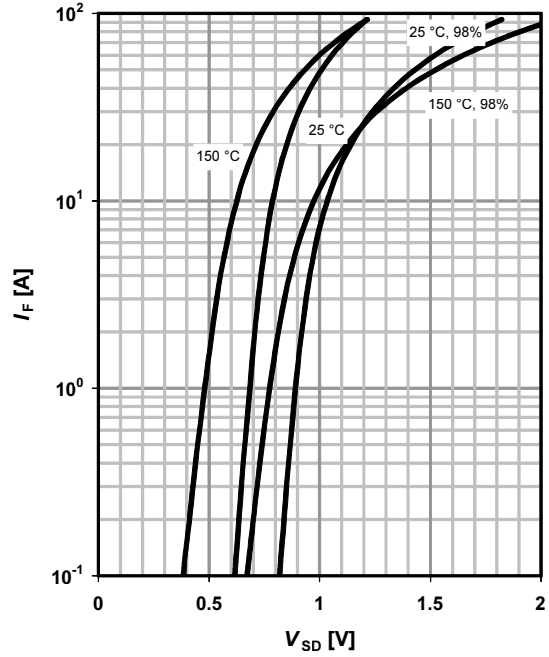

11 Avalanche energy

$E_{AS}=f(T_j); I_D=11\text{ A}; V_{DD}=50\text{ V}$

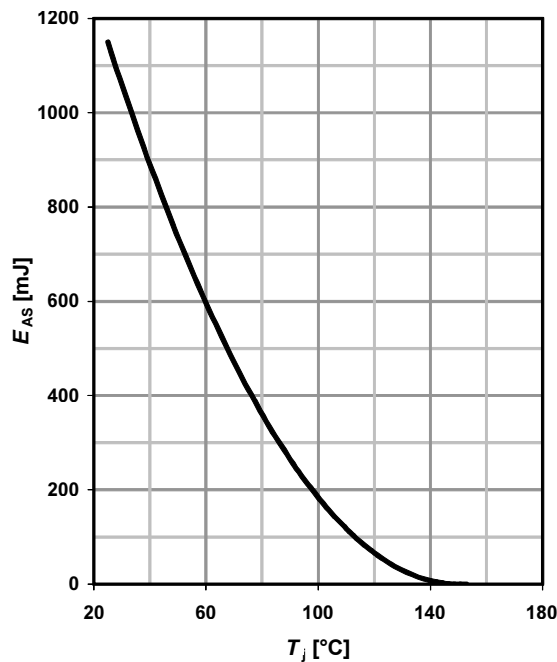

12 Drain-source breakdown voltage

$V_{BR(DSS)}=f(T_j); I_D=0.25\text{ mA}$

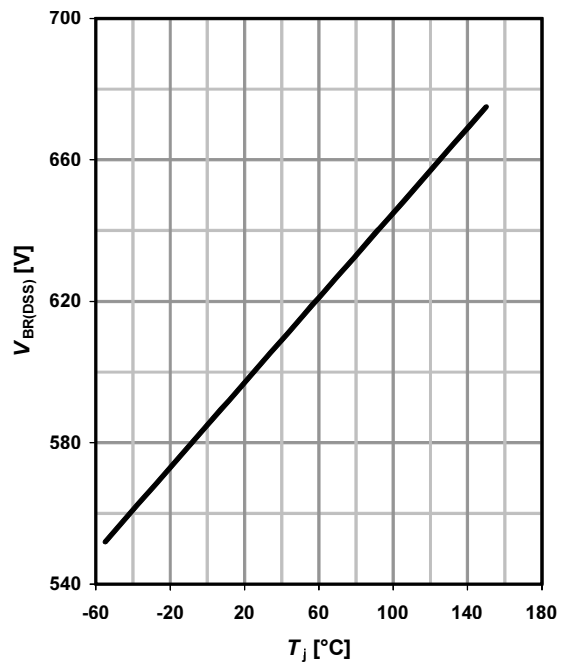

13 Typ. capacitances

$C = f(V_{DS}); V_{GS} = 0 \text{ V}; f = 1 \text{ MHz}$

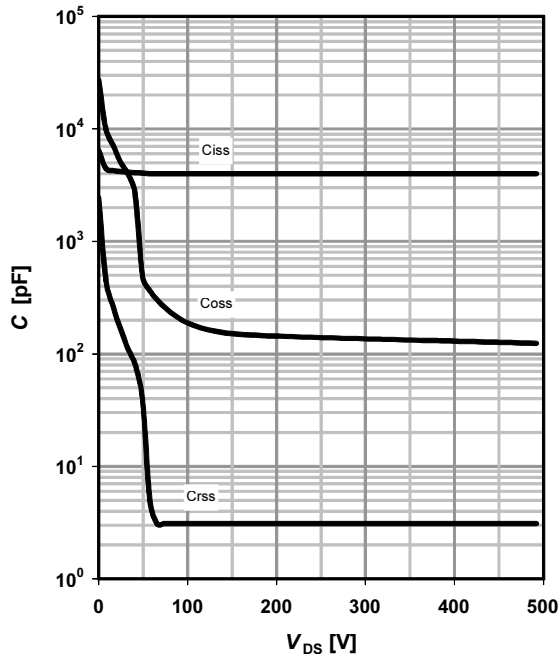

14 Typ. Coss stored energy

$E_{oss} = f(V_{DS})$

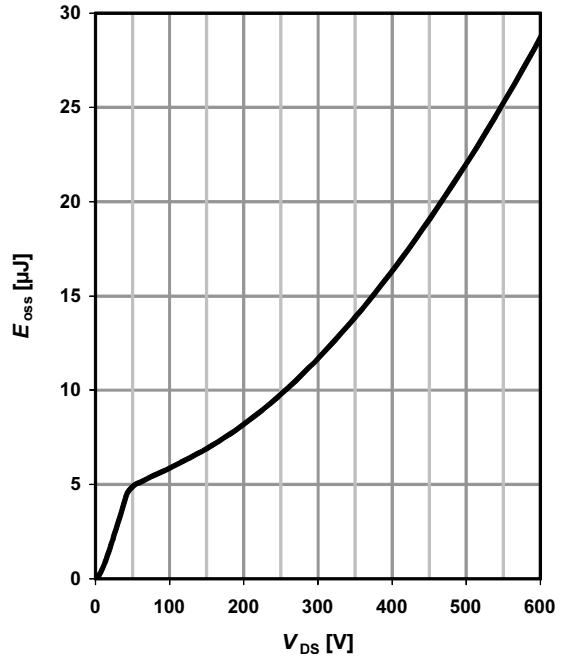

Definition of diode switching characteristics



PG-T0247-3-21-41: Outlines

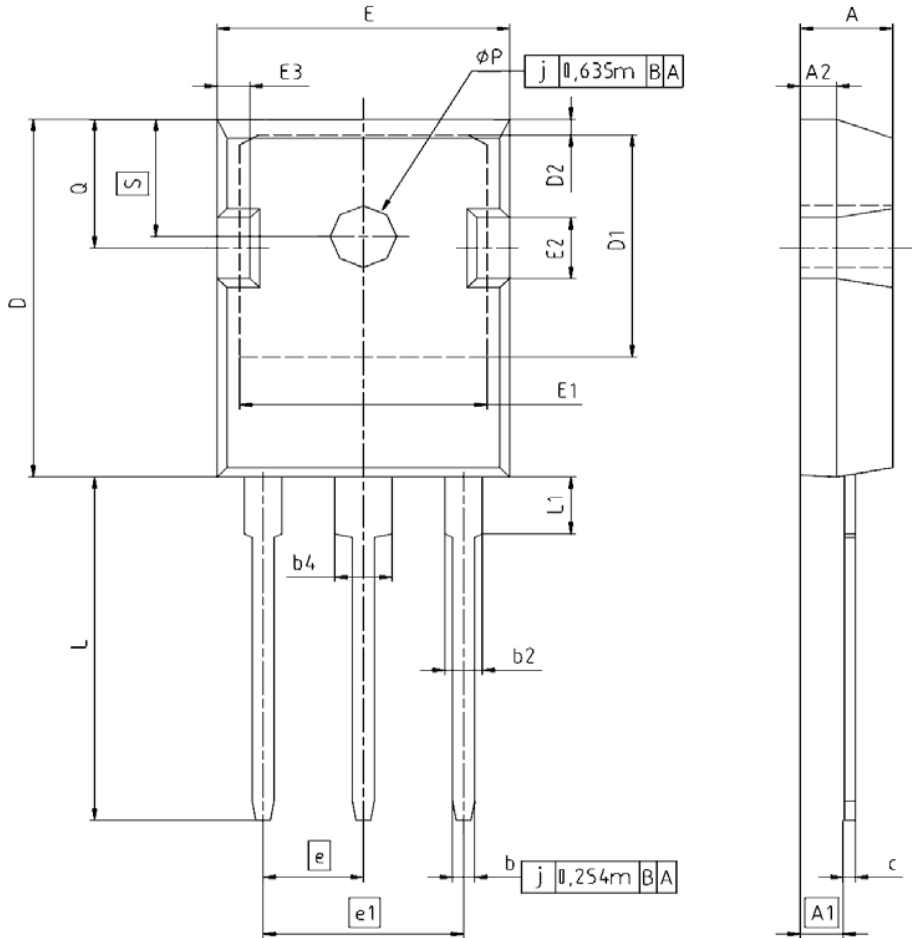

| DIM | MILLIMETERS | | INCHES | |
|-----|-------------|-------|--------|-------|
| | MIN | MAX | MIN | MAX |
| A | 4.90 | 5.16 | 0.193 | 0.203 |
| A1 | 2.27 | 2.53 | 0.089 | 0.099 |
| A2 | 1.85 | 2.11 | 0.073 | 0.083 |
| b | 1.07 | 1.33 | 0.042 | 0.052 |
| b2 | 1.90 | 2.39 | 0.075 | 0.094 |
| b4 | 2.87 | 3.45 | 0.113 | 0.136 |
| c | 0.55 | 0.75 | 0.022 | 0.030 |
| D | 20.82 | 21.10 | 0.820 | 0.831 |
| D1 | 16.25 | 17.83 | 0.640 | 0.702 |
| D2 | 1.05 | 1.35 | 0.041 | 0.053 |
| E | 15.70 | 16.03 | 0.618 | 0.631 |
| E1 | 13.10 | 14.15 | 0.516 | 0.557 |
| E2 | 3.68 | 5.10 | 0.145 | 0.201 |
| E3 | 1.68 | 2.60 | 0.066 | 0.102 |
| e | 5.44 | | 0.214 | |
| e1 | 10.90 | | 0.429 | |
| N | 3 | | 3 | |
| L | 19.80 | 20.31 | 0.780 | 0.799 |
| L1 | 4.17 | 4.47 | 0.164 | 0.176 |
| øP | 3.50 | 3.70 | 0.138 | 0.146 |
| Q | 5.49 | 6.00 | 0.216 | 0.236 |
| S | 6.04 | 6.30 | 0.238 | 0.248 |

DOCUMENT NO.
Z8B00003327

SCALE
0 5 5 7.5mm

EUROPEAN PROJECTION

ISSUE DATE
30-03-2007

REVISION
02



Published by
Infineon Technologies AG
81726 Munich, Germany
© 2007 Infineon Technologies AG
All Rights Reserved.

Legal Disclaimer

The information given in this document shall in no event be regarded as a guarantee of conditions or characteristics. With respect to any examples or hints given herein, any typical values stated herein and/or any information regarding the application of the device, Infineon Technologies hereby disclaims any and all warranties and liabilities of any kind, including without limitation, warranties of non-infringement of intellectual property rights of any third party.

Information

For further information on technology, delivery terms and conditions and prices, please contact the nearest Infineon Technologies Office (www.infineon.com).

Warnings

Due to technical requirements, components may contain dangerous substances. For information on the types in question, please contact the nearest Infineon Technologies Office. The Infineon Technologies component described in this Data Sheet may be used in life-support devices or systems and/or automotive, aviation and aerospace applications or systems only with the express written approval of Infineon Technologies, if a failure of such components can reasonably be expected to cause the failure of that life-support, automotive, aviation and aerospace device or system or to affect the safety or effectiveness of that device or system. Life support devices or systems are intended to be implanted in the human body or to support and/or maintain and sustain and/or protect human life. If they fail, it is reasonable to assume that the health of the user or other persons may be endangered.

1 New package outlines TO-247

Assembly capacity extension for CoolMOSTM technology products assembled in lead-free package PG-TO247-3 at subcontractor ASE (Weihai) Inc., China (Changes are marked in blue.)



Figure 1 Outlines TO-247, dimensions in mm/inches

单击下面可查看定价，库存，交付和生命周期等信息

[>>Infineon\(英飞凌\)](#)