

OptiMOS™ -5 Power Transistor

Features

- OptiMOS™ power MOSFET for automotive applications
- N-channel - Enhancement mode - Logic level
- MSL1 up to 260°C peak reflow
- 175 °C operating temperature
- Green product (RoHS compliant)
- 100% Avalanche tested

Product Summary

| | | |
|------------------|----|----|
| V_{DS} | 60 | V |
| $R_{DS(on),max}$ | 14 | mΩ |
| I_D | 30 | A |

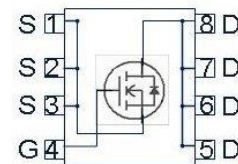
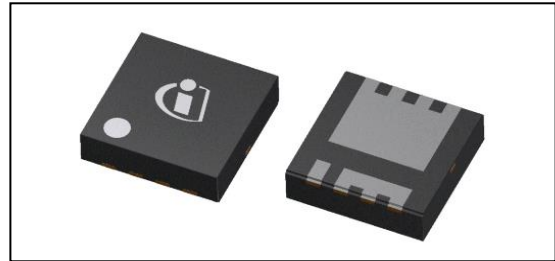
PG-TSDSON-8-32

| Type | Package | Marking |
|-----------------|--------------------------------|---------|
| IAUZ30N06S5L140 | PG-TSDSON-8-32 | 5N6L140 |

Maximum ratings, at $T_j=25\text{ °C}$, unless otherwise specified

| Parameter | Symbol | Conditions | Value | Unit |
|--|----------------|--|--------------|------|
| Drain current | I_D | $V_{GS}=10\text{ V}$, Chip limitation ^{1,2)} | 30 | A |
| | | $V_{GS}=10\text{V}$, DC current | 30 | |
| | | $T_a=85\text{ °C}$, $V_{GS}=10\text{ V}$, R_{thJA} on 2s2p ^{2,3)} | 8 | |
| Pulsed drain current ²⁾ | $I_{D,pulse}$ | $T_C=25\text{ °C}$, $t_p=100\text{ }\mu\text{s}$ | 85 | |
| Avalanche energy, single pulse ²⁾ | E_{AS} | $I_D=15\text{ A}$ | 27 | mJ |
| Avalanche current, single pulse | I_{AS} | - | 30 | A |
| Gate source voltage | V_{GS} | - | ± 16 | V |
| Power dissipation | P_{tot} | $T_C=25\text{ °C}$ | 33 | W |
| Operating and storage temperature | T_j, T_{stg} | - | -55 ... +175 | °C |

| Parameter | Symbol | Conditions | Values | | | Unit |
|-----------|--------|------------|--------|------|------|------|
| | | | min. | typ. | max. | |

Thermal characteristics²⁾

| | | | | | | |
|--|------------|---|---|------|-----|-----|
| Thermal resistance, junction - case | R_{thJC} | - | - | - | 4.6 | K/W |
| Thermal resistance, junction - ambient ³⁾ | R_{thJA} | - | - | 37.2 | - | |

Electrical characteristics, at $T_j=25^\circ\text{C}$, unless otherwise specified
Static characteristics

| | | | | | | |
|----------------------------------|---------------|---|-----|------|------|-----------|
| Drain-source breakdown voltage | $V_{(BR)DSS}$ | $V_{GS}=0V, I_D=1mA$ | 60 | - | - | V |
| Gate threshold voltage | $V_{GS(th)}$ | $V_{DS}=V_{GS}, I_D=10\mu A$ | 1.2 | 1.7 | 2.2 | |
| Zero gate voltage drain current | I_{DSS} | $V_{DS}=60V, V_{GS}=0V, T_j=25^\circ\text{C}$ | - | - | 1 | μA |
| | | $V_{DS}=60V, V_{GS}=0V, T_j=125^\circ\text{C}^{1)}$ | - | - | 100 | |
| Gate-source leakage current | I_{GSS} | $V_{GS}=16V, V_{DS}=0V$ | - | - | 100 | nA |
| Drain-source on-state resistance | $R_{DS(on)}$ | $V_{GS}=4.5V, I_D=15A$ | - | 16.3 | 19.6 | $m\Omega$ |
| | | $V_{GS}=10V, I_D=15A$ | - | 11.2 | 14 | |
| Gate resistance ²⁾ | R_G | - | - | 1.4 | - | Ω |

| Parameter | Symbol | Conditions | Values | | | Unit |
|-----------|--------|------------|--------|------|------|------|
| | | | min. | typ. | max. | |

Dynamic characteristics²⁾

| | | | | | | |
|------------------------------|--------------|---|---|-----|-----|----|
| Input capacitance | C_{iss} | $V_{GS}=0V, V_{DS}=30V,$ $f=1MHz$ | - | 683 | 888 | pF |
| Output capacitance | C_{oss} | | - | 136 | 177 | |
| Reverse transfer capacitance | C_{rss} | | - | 10 | 15 | |
| Turn-on delay time | $t_{d(on)}$ | $V_{DD}=30V, V_{GS}=10V,$ $I_D=15A, R_{G,ext}=3.5\Omega$ | - | 1.6 | - | ns |
| Turn-off delay time | $t_{d(off)}$ | | - | 4.1 | - | |
| Rise time | t_r | | - | 1.0 | - | |
| Fall time | t_f | | - | 1.8 | - | |

Gate Charge Characteristics²⁾

| | | | | | | |
|-----------------------|---------------|---|---|-----|------|----|
| Gate to source charge | Q_{gs} | $V_{DD}=30V, I_D=15A,$ $V_{GS}=0$ to 10V | - | 2.3 | 2.9 | nC |
| Gate to drain charge | Q_{gd} | | - | 1.6 | 2.4 | |
| Gate charge total | Q_g | | - | 9.4 | 12.2 | |
| Gate plateau voltage | $V_{plateau}$ | | - | 3.3 | - | V |

Reverse Diode

| | | | | | | |
|--|---------------|---|---|-----|-----|----|
| Diode continuous forward current ²⁾ | I_S | $T_C=25^\circ C$ | - | - | 30 | A |
| Diode pulse current ²⁾ | $I_{S,pulse}$ | $T_C=25^\circ C, t_p=100\mu s$ | - | - | 85 | |
| Diode forward voltage | V_{SD} | $V_{GS}=0V, I_F=15A,$ $T_j=25^\circ C$ | - | 0.8 | 1.1 | V |
| Reverse recovery time ²⁾ | t_{rr} | $V_R=30V, I_F=30A,$ $di_F/dt=100A/\mu s$ | - | 26 | - | ns |
| Reverse recovery charge ²⁾ | Q_{rr} | | - | 18 | - | nC |

¹⁾ Practically the current is limited by the overall system design including the customer-specific PCB.

²⁾ The parameter is not subject to production test - verified by design/characterization.

³⁾ Device on a four-layer 2s2p FR4 PCB defined in accordance with JEDEC standards (JESD51-5-7). PCB is vertical in still air.

1 Power dissipation

$$P_{\text{tot}} = f(T_C); V_{\text{GS}} = 10 \text{ V}$$

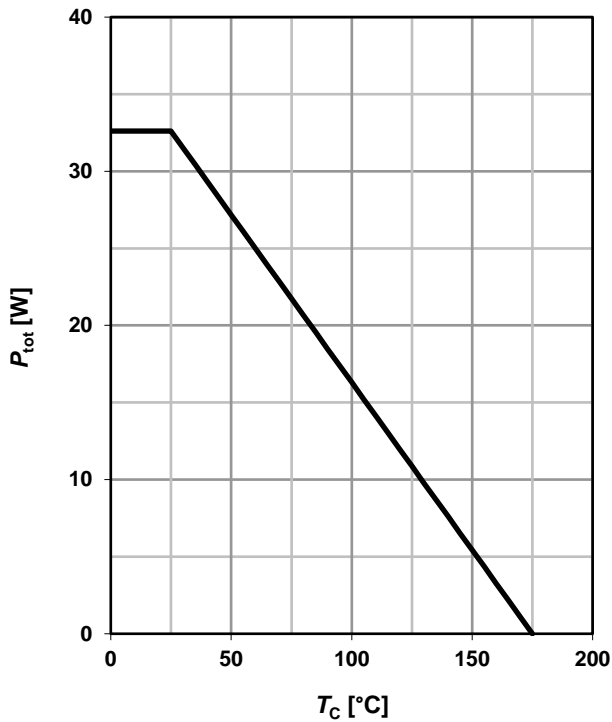
2 Drain current

$$I_D = f(T_C); V_{\text{GS}} = 10 \text{ V}$$

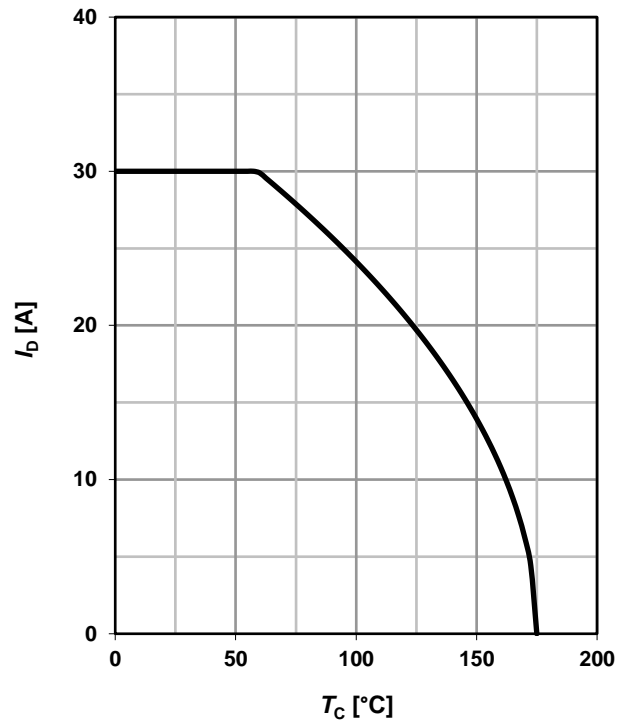
3 Safe operating area

$$I_D = f(V_{\text{DS}}); T_C = 25 \text{ °C}; D = 0$$

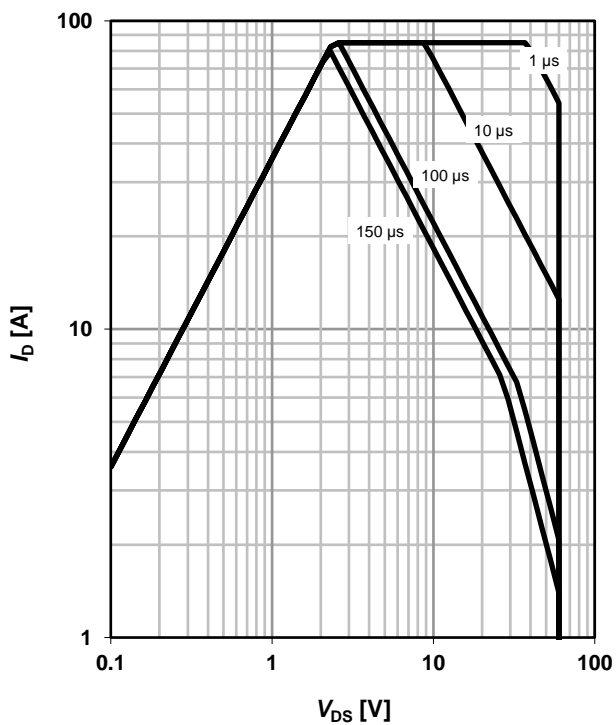
 parameter: t_p

4 Max. transient thermal impedance

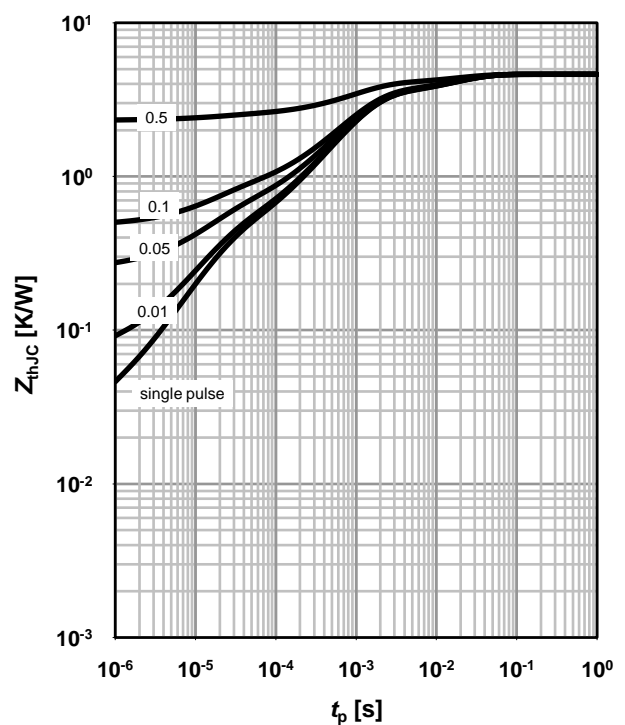
$$Z_{\text{thJC}} = f(t_p)$$

 parameter: $D = t_p/T$

5 Typ. output characteristics

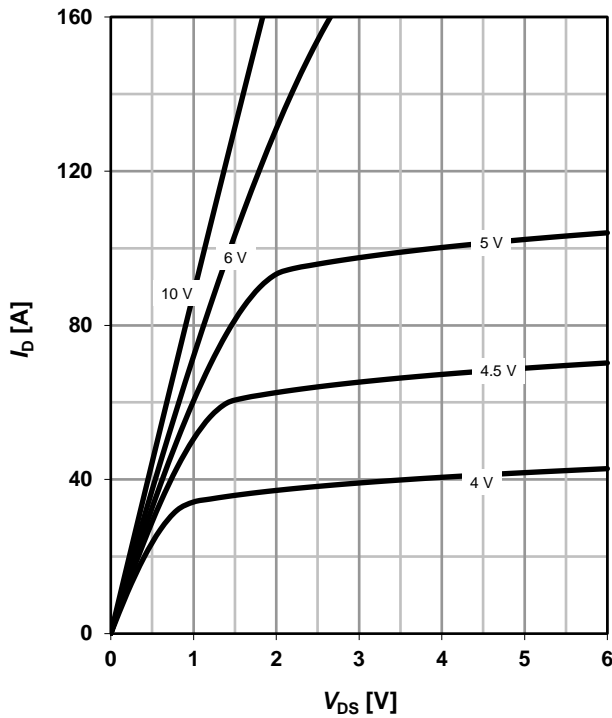
$$I_D = f(V_{DS}); T_j = 25\text{ }^\circ\text{C}$$

 parameter: V_{GS}

6 Typ. drain-source on-state resistance

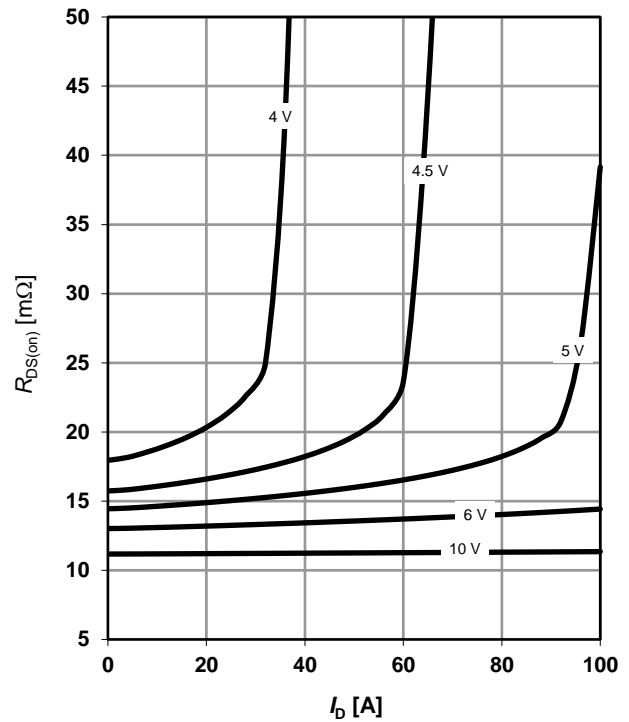
$$R_{DS(on)} = f(I_D); T_j = 25\text{ }^\circ\text{C}$$

 parameter: V_{GS}

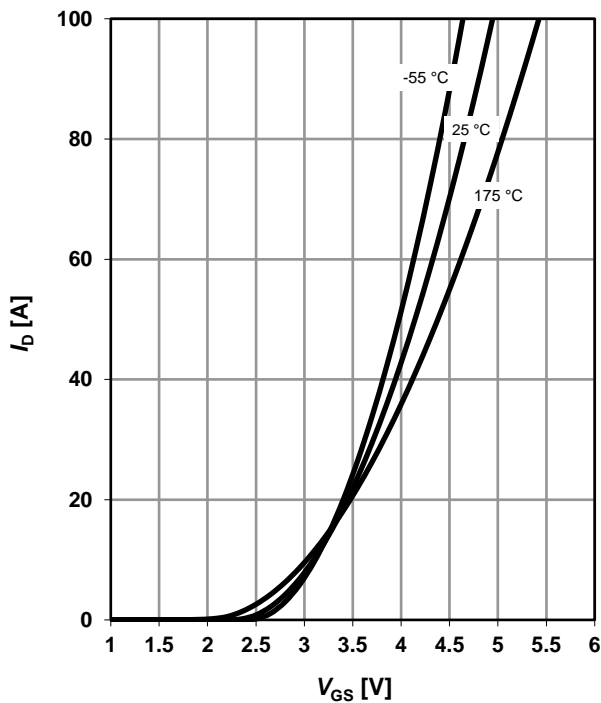
7 Typ. transfer characteristics

$$I_D = f(V_{GS}); V_{DS} = 6\text{ V}$$

 parameter: T_j

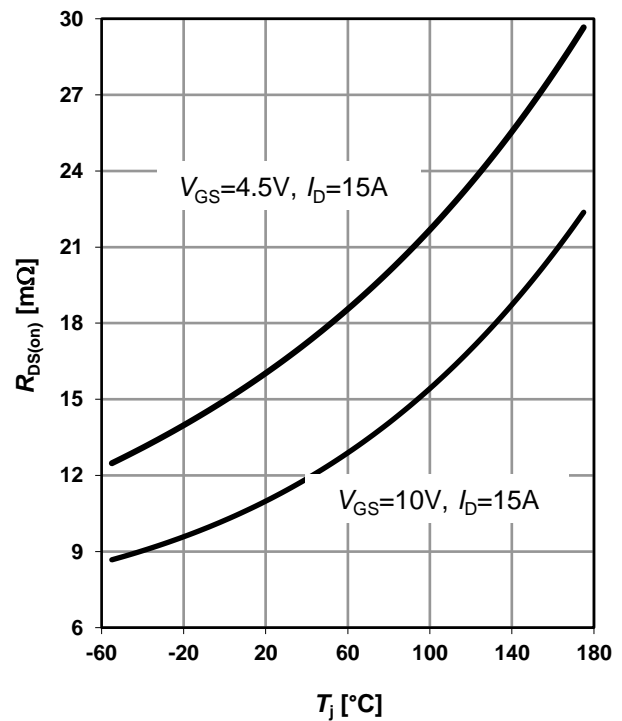
8 Typ. drain-source on-state resistance

$$R_{DS(on)} = f(T_j);$$

 parameter: I_D, V_{GS}

9 Typ. gate threshold voltage

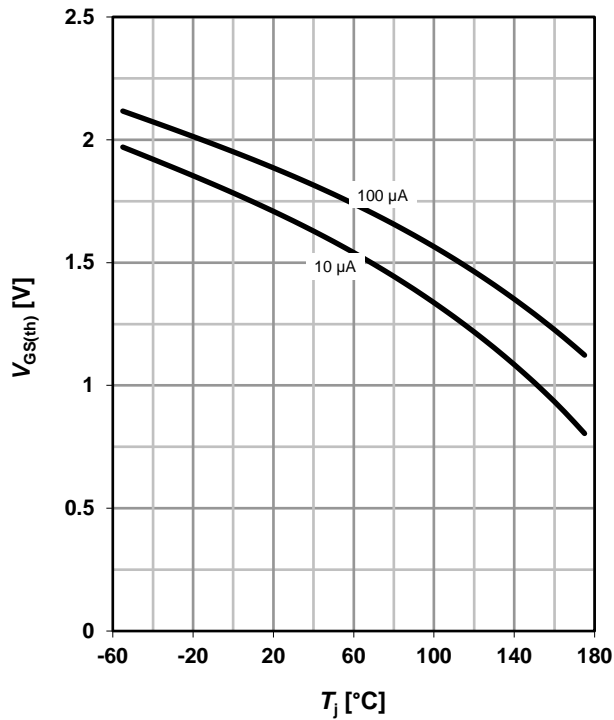
$$V_{GS(th)} = f(T_j); V_{GS} = V_{DS}$$

 parameter: I_D

10 Typ. capacitances

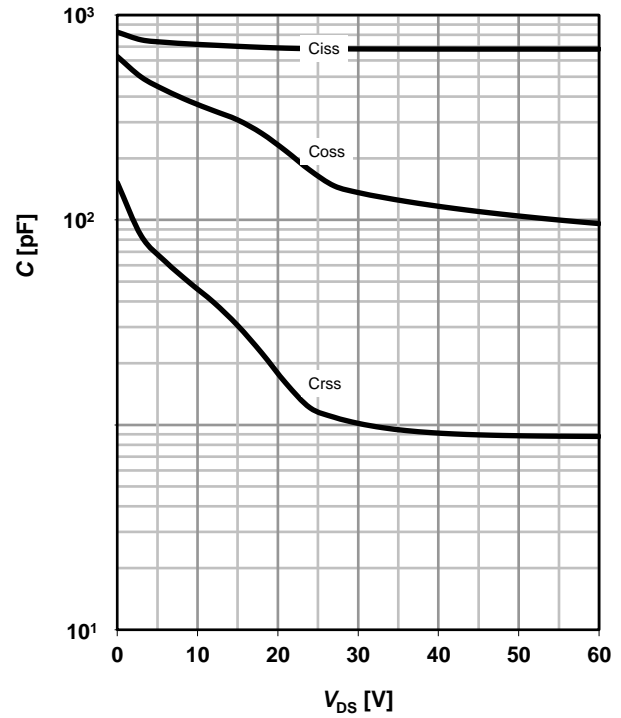
$$C = f(V_{DS}); V_{GS} = 0 V; f = 1 MHz$$

11 Typical forward diode characteristics

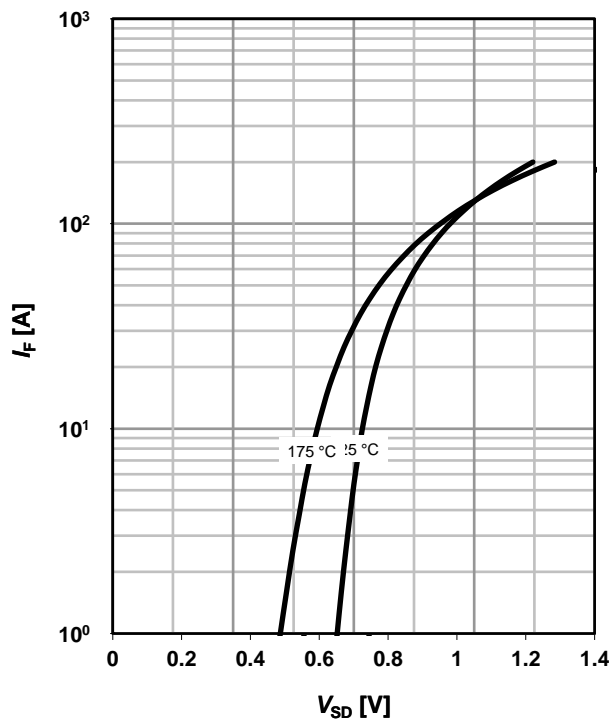
$$I_F = f(V_{SD})$$

 parameter: T_j

12 Avalanche characteristics

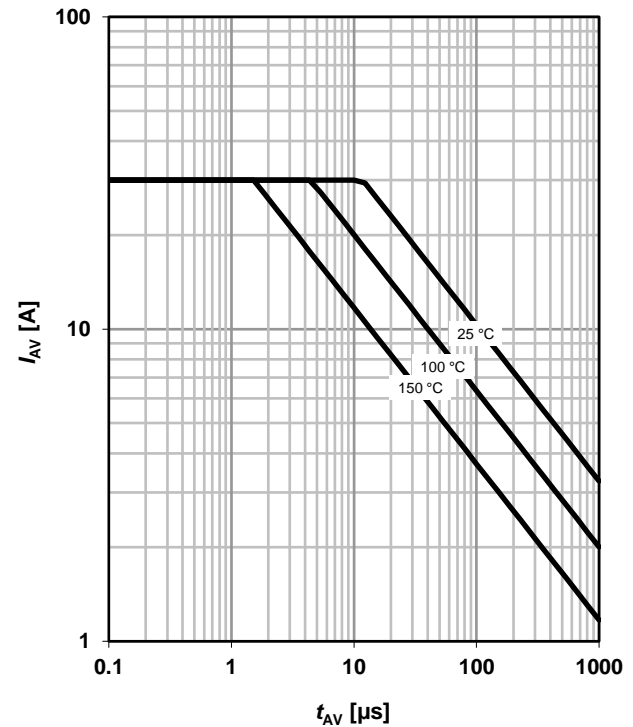
$$I_{AS} = f(t_{AV})$$

 parameter: $T_{j(start)}$

13 Avalanche energy

$$E_{AS} = f(T_j)$$

parameter: I_D

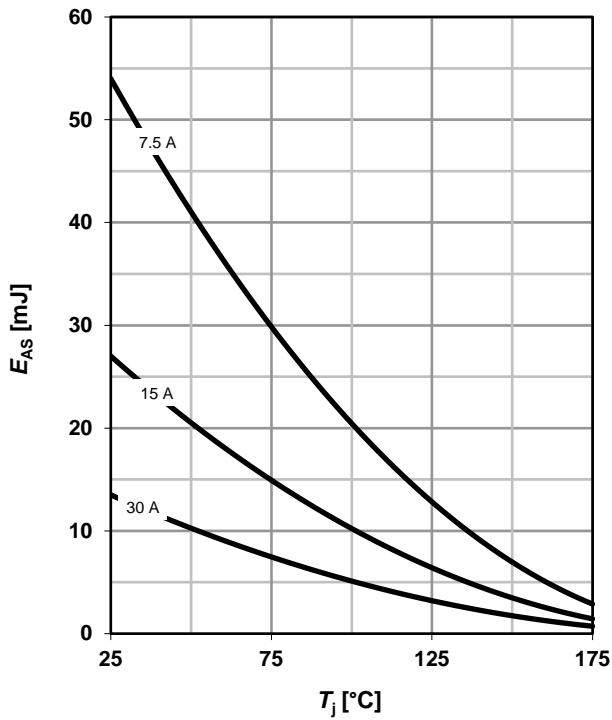

14 Drain-source breakdown voltage

$$V_{BR(DSS)} = f(T_j); I_D = 1 \text{ mA}$$

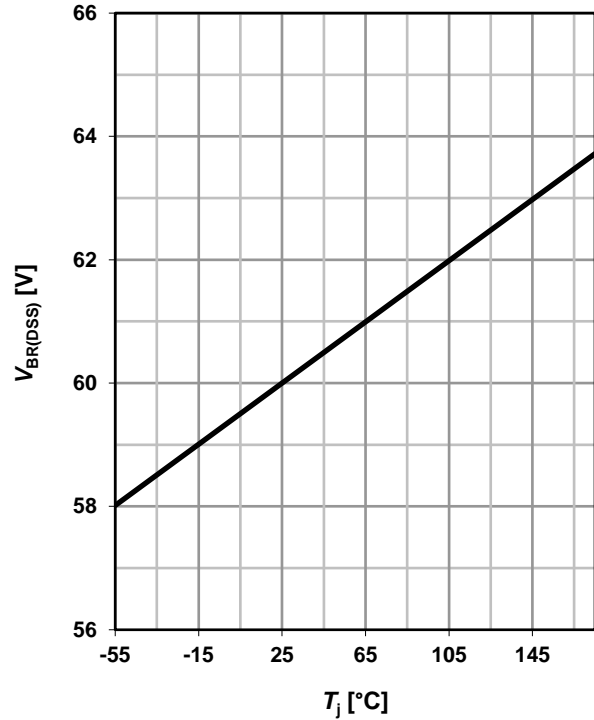

15 Typ. gate charge

$$V_{GS} = f(Q_{gate}); I_D = 15 \text{ A pulsed}$$

parameter: V_{DD}

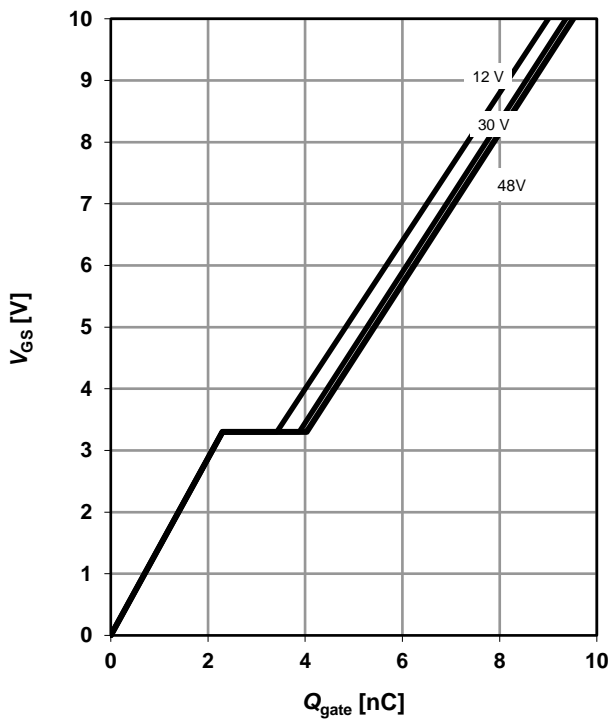

16 Gate charge waveforms

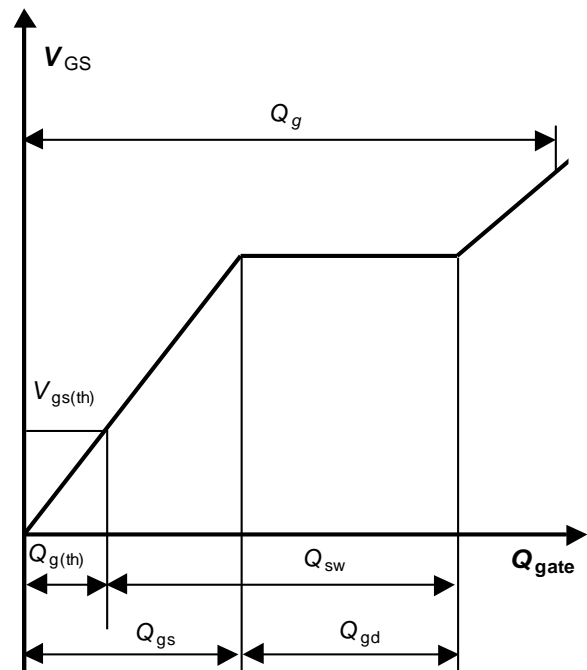

Package Outline

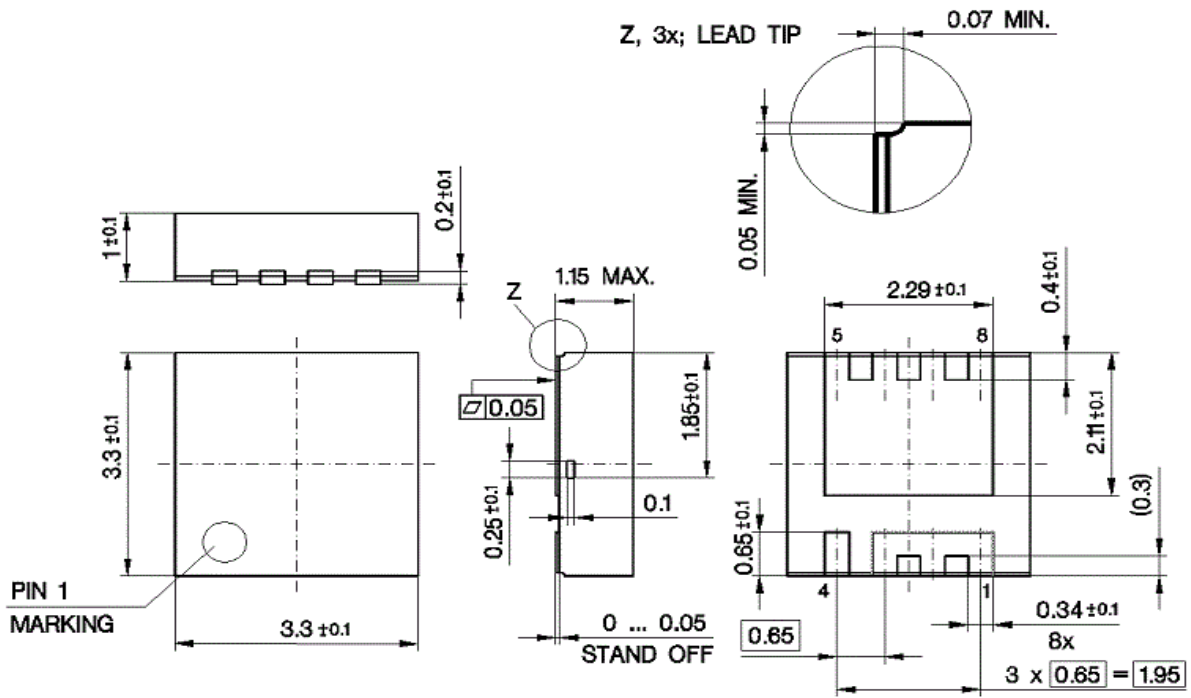

Footprint

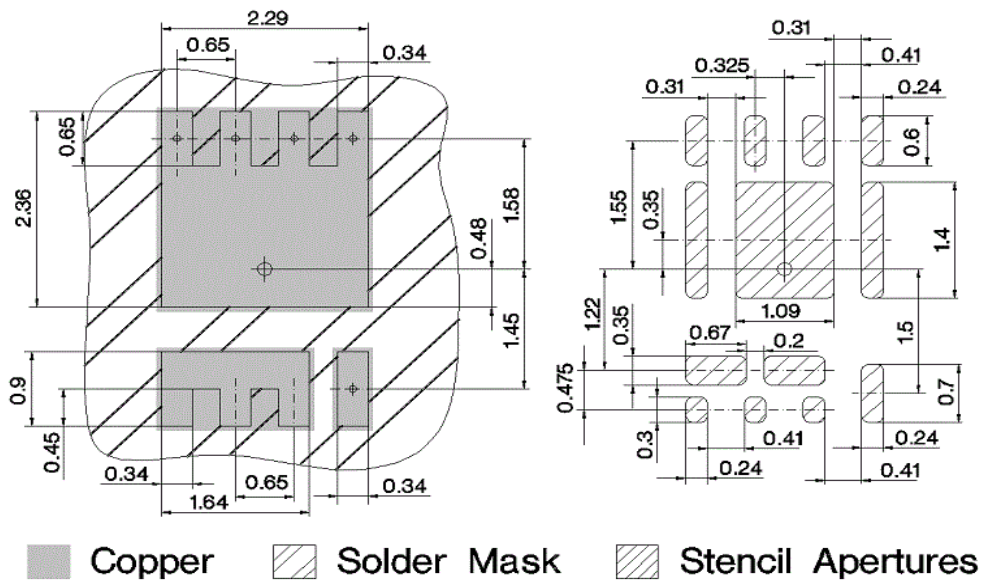

Packaging

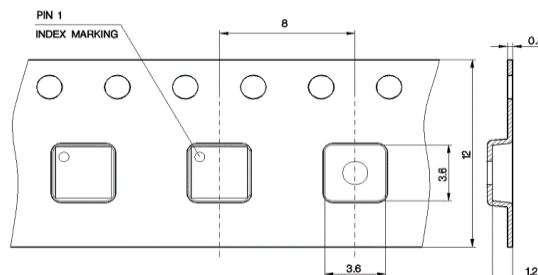

Published by
Infineon Technologies AG
81726 Munich, Germany

© Infineon Technologies AG 2020
All Rights Reserved.

Legal Disclaimer

The information given in this document shall in no event be regarded as a guarantee of conditions or characteristics. With respect to any examples or hints given herein, any typical values stated herein and/or any information regarding the application of the device, Infineon Technologies hereby disclaims any and all warranties and liabilities of any kind, including without limitation, warranties of non-infringement of intellectual property rights of any third party.

Information

For further information on technology, delivery terms and conditions and prices, please contact the nearest Infineon Technologies Office (www.infineon.com).

Warnings

Due to technical requirements, components may contain dangerous substances.
For information on the types in question, please contact the nearest Infineon Technologies Office.
Infineon Technologies components may be used in life-support devices or systems only with the express written approval of Infineon Technologies, if a failure of such components can reasonably be expected to cause the failure of that life-support device or system or to affect the safety or effectiveness of that device or system. Life support devices or systems are intended to be implanted in the human body or to support and/or maintain and sustain and/or protect human life.
If they fail, it is reasonable to assume that the health of the user or other persons may be endangered.

Revision History

| Version | Date | Changes |
|--------------|------------|------------------|
| Revision 1.0 | 07.05.2020 | Final Data Sheet |

单击下面可查看定价，库存，交付和生命周期等信息

[>>Infineon\(英飞凌\)](#)