

IRG4PH50KPbF

INSULATED GATE BIPOLAR TRANSISTOR

Short Circuit Rated UltraFast IGBT

Features

- High short circuit rating optimized for motor control, $t_{sc} = 10\mu s$, $V_{CC} = 720V$, $T_J = 125^\circ C$, $V_{GE} = 15V$
- Combines low conduction losses with high switching speed
- Latest generation design provides tighter parameter distribution and higher efficiency than previous generations
- Lead-Free

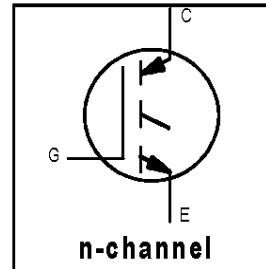

$V_{CES} = 1200V$
$V_{CE(on) typ.} = 2.77V$
@ $V_{GE} = 15V$, $I_C = 24A$

Benefits

- As a Freewheeling Diode we recommend our HEXFRED™ ultrafast, ultrasoft recovery diodes for minimum EMI/Noise and switching losses in the Diode and IGBT
- Latest generation 4 IGBTs offer highest power density motor controls possible
- This part replaces the IRGPH50K and IRGPH50M devices

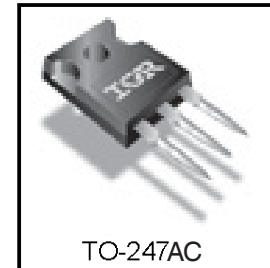

Absolute Maximum Ratings

	Parameter	Max.	Units
V_{CES}	Collector-to-Emitter Voltage	1200	V
$I_C @ T_C = 25^\circ C$	Continuous Collector Current	45	A
$I_C @ T_C = 100^\circ C$	Continuous Collector Current	24	
I_{CM}	Pulsed Collector Current ①	90	
I_{LM}	Clamped Inductive Load Current ②	90	
t_{sc}	Short Circuit Withstand Time	10	μs
V_{GE}	Gate-to-Emitter Voltage	± 20	V
E_{ARV}	Reverse Voltage Avalanche Energy ③	190	mJ
$P_D @ T_C = 25^\circ C$	Maximum Power Dissipation	200	W
$P_D @ T_C = 100^\circ C$	Maximum Power Dissipation	78	
T_J	Operating Junction and	-55 to +150	$^\circ C$
T_{STG}	Storage Temperature Range		
	Soldering Temperature, for 10 sec.	300 (0.063 in. (1.6mm) from case)	
	Mounting torque, 6-32 or M3 screw.	10 lbf·in (1.1 N·m)	

Thermal Resistance

	Parameter	Typ.	Max.	Units
$R_{\theta JC}$	Junction-to-Case	—	0.64	$^\circ C/W$
$R_{\theta CS}$	Case-to-Sink, Flat, Greased Surface	0.24	—	
$R_{\theta JA}$	Junction-to-Ambient, typical socket mount	—	40	
Wt	Weight	6 (0.21)	—	g (oz)

Electrical Characteristics @ $T_J = 25^\circ\text{C}$ (unless otherwise specified)

	Parameter	Min.	Typ.	Max.	Units	Conditions
$V_{(BR)CES}$	Collector-to-Emitter Breakdown Voltage	1200	—	—	V	$V_{GE} = 0V, I_C = 250\mu A$
$V_{(BR)ECS}$	Emitter-to-Collector Breakdown Voltage	18	—	—	V	$V_{GE} = 0V, I_C = 1.0A$
$\Delta V_{(BR)CES}/\Delta T_J$	Temperature Coeff. of Breakdown Voltage	—	0.91	—	V/°C	$V_{GE} = 0V, I_C = 2.0mA$
$V_{CE(ON)}$	Collector-to-Emitter Saturation Voltage	—	2.77	3.5	V	$I_C = 24A, V_{GE} = 15V$
		—	3.28	—		$I_C = 45A$ see figures 2, 5
		—	2.54	—		$I_C = 24A, T_J = 150^\circ\text{C}$
$V_{GE(th)}$	Gate Threshold Voltage	3.0	—	6.0		$V_{CE} = V_{GE}, I_C = 250\mu A$
$\Delta V_{GE(th)}/\Delta T_J$	Temperature Coeff. of Threshold Voltage	—	-10	—	mV/°C	$V_{CE} = V_{GE}, I_C = 2.0mA$
g_{fe}	Forward Transconductance	13	19	—	S	$V_{CE} = 100V, I_C = 24A$
I_{CES}	Zero Gate Voltage Collector Current	—	—	250	μA	$V_{GE} = 0V, V_{CE} = 1200V$
		—	—	2.0		$V_{GE} = 0V, V_{CE} = 10V, T_J = 25^\circ\text{C}$
		—	—	5000		$V_{GE} = 0V, V_{CE} = 1200V, T_J = 150^\circ\text{C}$
I_{GES}	Gate-to-Emitter Leakage Current	—	—	± 100	nA	$V_{GE} = \pm 20V$

Switching Characteristics @ $T_J = 25^\circ\text{C}$ (unless otherwise specified)

	Parameter	Min.	Typ.	Max.	Units	Conditions
Q_g	Total Gate Charge (turn-on)	—	180	270	nC	$I_C = 24A$ $V_{CC} = 400V$ see figure 8 $V_{GE} = 15V$
Q_{ge}	Gate - Emitter Charge (turn-on)	—	25	38		
Q_{gc}	Gate - Collector Charge (turn-on)	—	70	110		
$t_{d(on)}$	Turn-On Delay Time	—	36	—	ns	$T_J = 25^\circ\text{C}$ $I_C = 24A, V_{CC} = 960V$ $V_{GE} = 15V, R_G = 5.0\Omega$ Energy losses include "tail" see figures 9,10,14
t_r	Rise Time	—	27	—		
$t_{d(off)}$	Turn-Off Delay Time	—	200	300		
t_f	Fall Time	—	130	190		
E_{on}	Turn-On Switching Loss	—	1.21	—	mJ	Energy losses include "tail" see figures 9,10,14
E_{off}	Turn-Off Switching Loss	—	2.25	—		
E_{ts}	Total Switching Loss	—	3.46	4.1		
t_{sc}	Short Circuit Withstand Time	10	—	—	μs	$V_{CC} = 720V, T_J = 125^\circ\text{C}$ $V_{GE} = 15V, R_G = 5.0\Omega$
$t_{d(on)}$	Turn-On Delay Time	—	35	—	ns	$T_J = 150^\circ\text{C}$, $I_C = 24A, V_{CC} = 960V$ $V_{GE} = 15V, R_G = 5.0\Omega$ Energy losses include "tail" see figures 10,11,14
t_r	Rise Time	—	29	—		
$t_{d(off)}$	Turn-Off Delay Time	—	380	—		
t_f	Fall Time	—	280	—		
E_{ts}	Total Switching Loss	—	7.80	—	mJ	see figures 10,11,14
L_E	Internal Emitter Inductance	—	13	—	nH	Measured 5mm from package
C_{ies}	Input Capacitance	—	2800	—	pF	$V_{GE} = 0V$ $V_{CC} = 30V$ see figure 7 $f = 1.0MHz$
C_{oes}	Output Capacitance	—	140	—		
C_{res}	Reverse Transfer Capacitance	—	53	—		

Notes:

- ① Repetitive rating; $V_{GE} = 20V$, pulse width limited by max. junction temperature. (see figure 13b)
- ② $V_{CC} = 80\% (V_{CES})$, $V_{GE} = 20V$, $L = 10\mu H$, $R_G = 5.0\Omega$, (see figure 13a)
- ③ Repetitive rating; pulse width limited by maximum junction temperature.
- ④ Pulse width $\leq 80\mu s$; duty factor $\leq 0.1\%$.
- ⑤ Pulse width $5.0\mu s$, single shot.

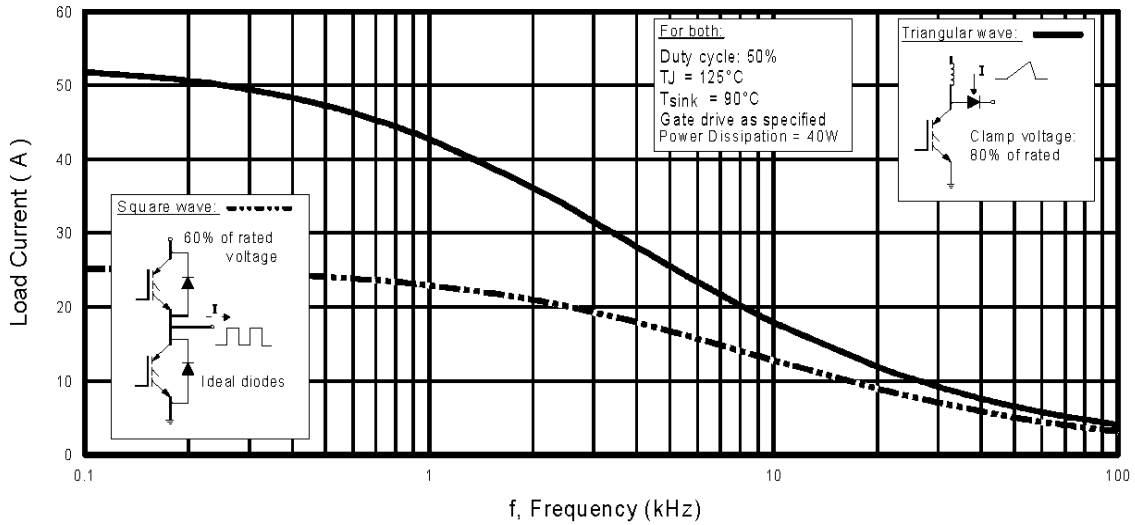

Fig. 1 - Typical Load Current vs. Frequency
(Load Current = I_{RMS} of fundamental)

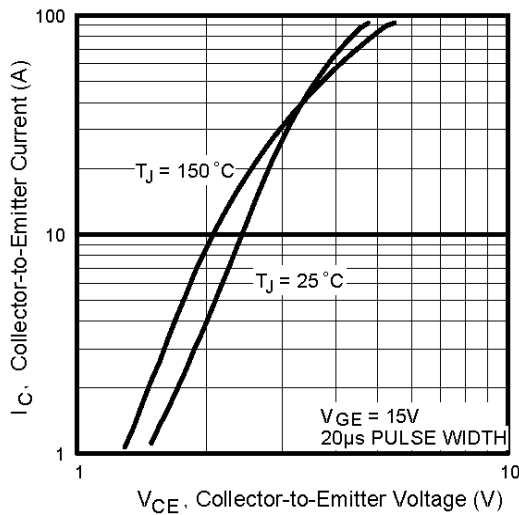

Fig. 2 - Typical Output Characteristics

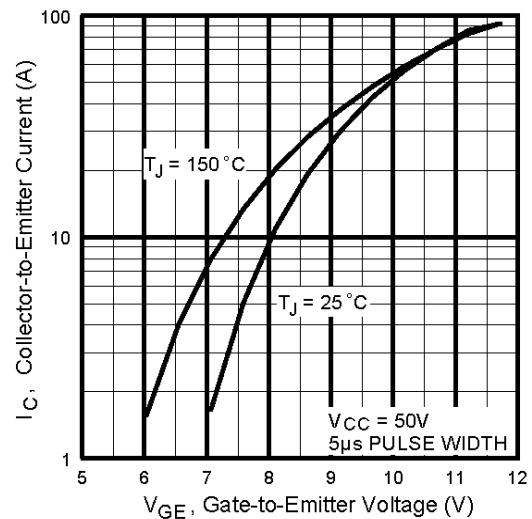

Fig. 3 - Typical Transfer Characteristics

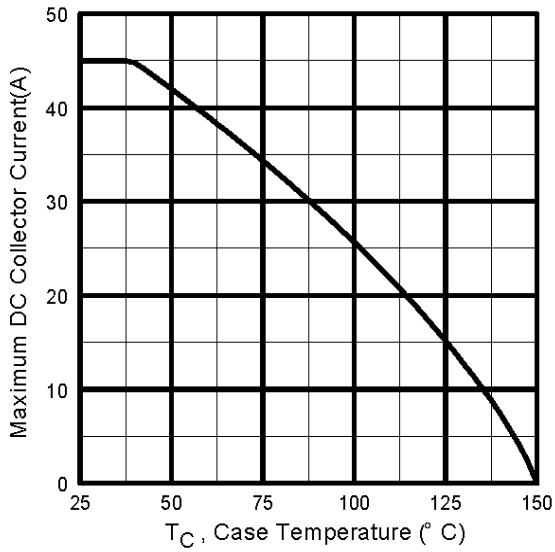

Fig. 4 - Maximum Collector Current vs. Case Temperature

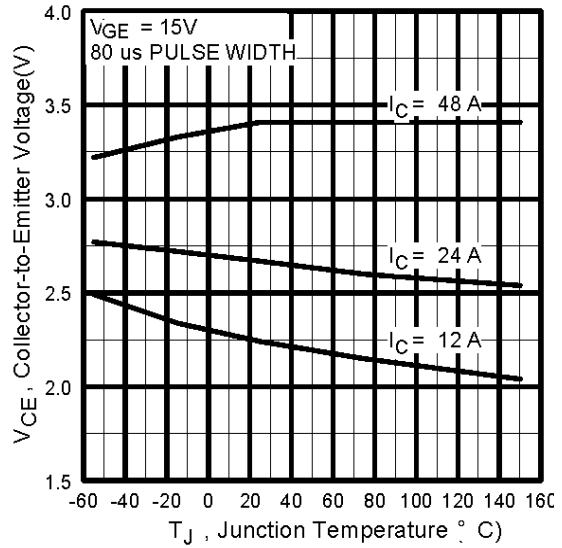

Fig. 5 - Typical Collector-to-Emitter Voltage vs. Junction Temperature

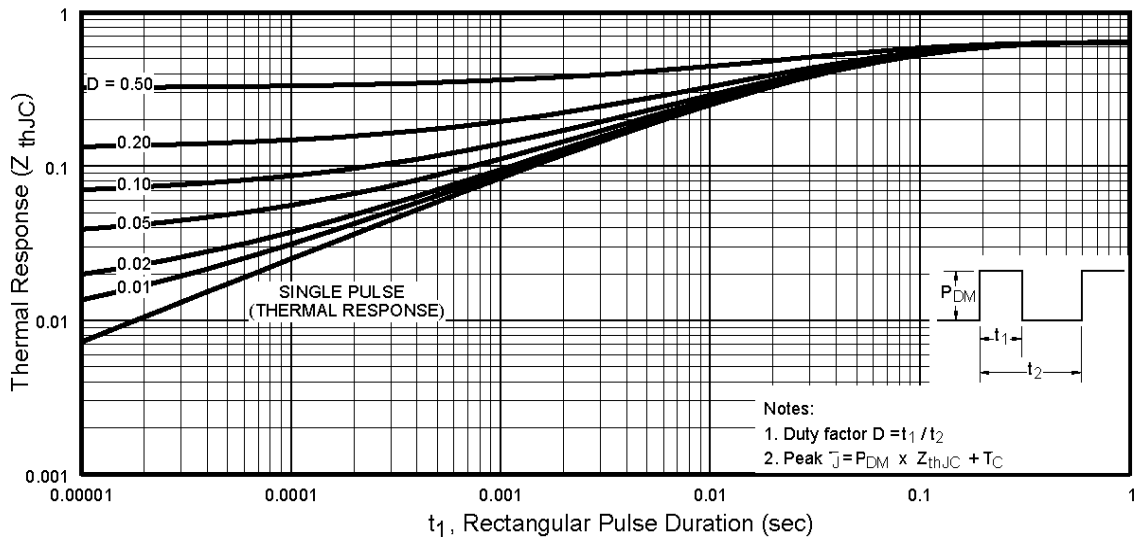

Fig. 6 - Maximum Effective Transient Thermal Impedance, Junction-to-Case

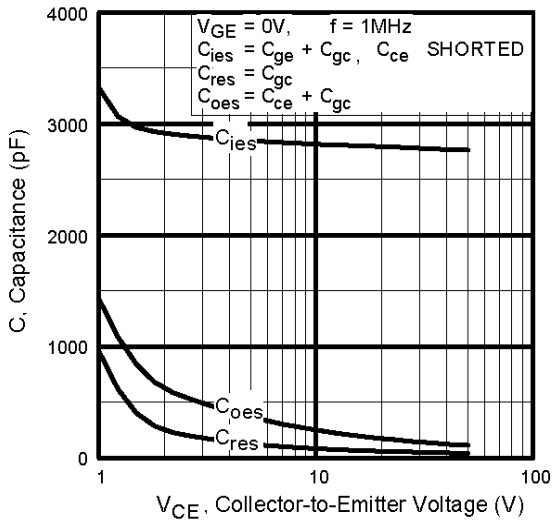

Fig. 7 - Typical Capacitance vs. Collector-to-Emitter Voltage

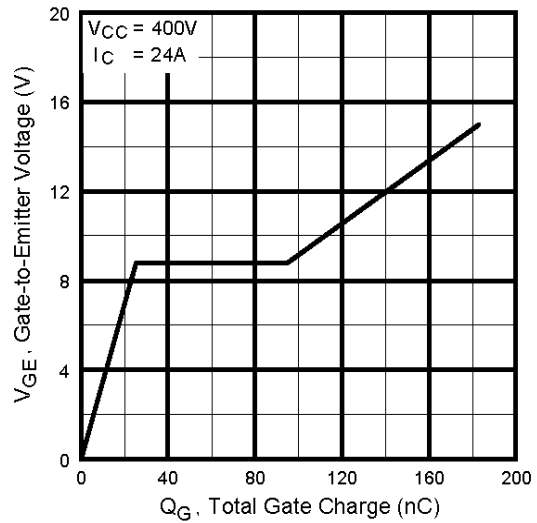

Fig. 8 - Typical Gate Charge vs. Gate-to-Emitter Voltage

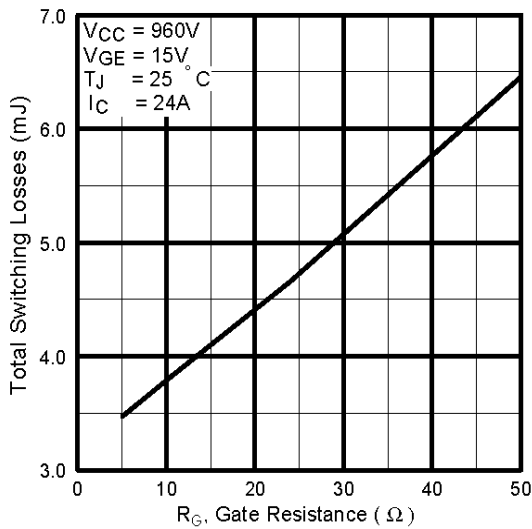

Fig. 9 - Typical Switching Losses vs. Gate Resistance

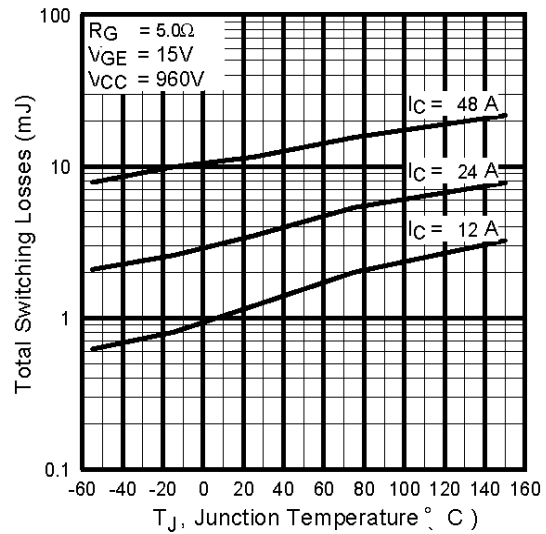

Fig. 10 - Typical Switching Losses vs. Junction Temperature

IRG4PH50KPbF

International
IR Rectifier

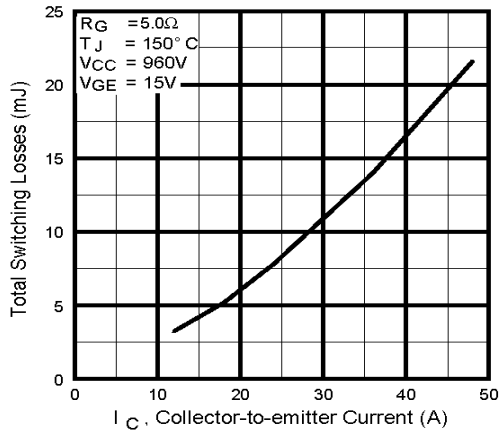

Fig. 11 - Typical Switching Losses vs. Collector-to-Emitter Current

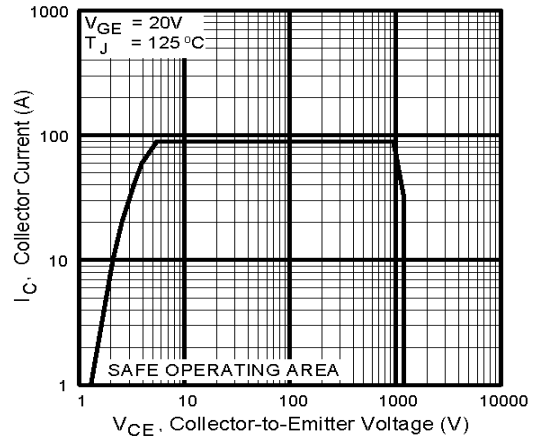

Fig. 12 - Turn-Off SOA

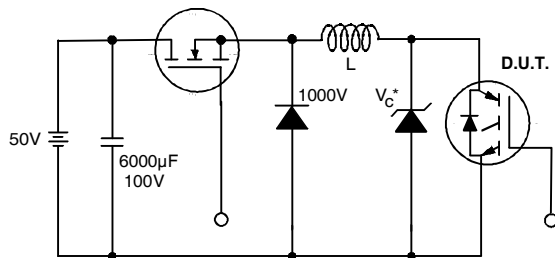

Fig. 13a. Clamped Inductive Load Test Circuit

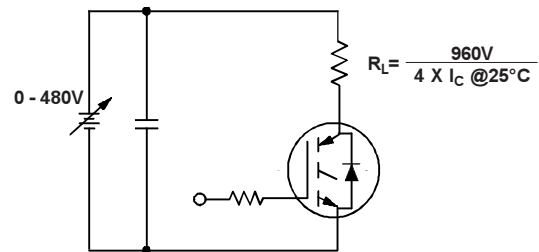
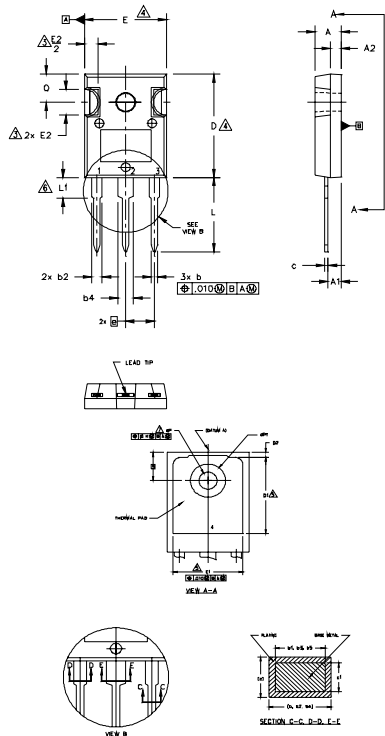

Fig. 13b. Pulsed Collector Current Test Circuit

TO-247AC Package Outline Dimensions are shown in millimeters (inches)



- NOTES:
1. DIMENSIONING AND TOLERANCING AS PER ASME Y14.5M 1994.
 2. DIMENSIONS ARE SHOWN IN INCHES.
 3. CONTOUR OF SLOT OPTIONAL.
 4. DIMENSION D & E DO NOT INCLUDE MOLD FLASH. MOLD FLASH SHALL NOT EXCEED .005" (0.127) PER SIDE. THESE DIMENSIONS ARE MEASURED AT THE OUTERMOST EXTREMES OF THE PLASTIC BODY.
 5. THERMAL PAD CONTOUR OPTIONAL WITHIN DIMENSIONS D1 & E1.
 6. LEAD FINISH UNCONTROLLED IN L1.
 7. ØP TO HAVE A MAXIMUM DRAFT ANGLE OF 1.5 ° TO THE TOP OF THE PART WITH A MAXIMUM HOLE DIAMETER OF .154 INCH.
 8. OUTLINE CONFORMS TO JEDEC OUTLINE TO-247AC .

SYMBOL	DIMENSIONS				NOTES
	INCHES		MILLIMETERS		
	MIN.	MAX.	MIN.	MAX.	
A	.183	.209	4.65	5.31	
A1	.087	.102	2.21	2.59	
A2	.059	.098	1.50	2.49	
b	.039	.055	0.99	1.40	
b1	.039	.053	0.99	1.35	
b2	.065	.094	1.65	2.39	
b3	.065	.092	1.65	2.34	
b4	.102	.135	2.59	3.43	
b5	.102	.133	2.59	3.38	
c	.015	.035	0.38	0.89	
c1	.015	.033	0.38	0.84	
D	.776	.815	19.71	20.70	4
D1	.515	-	13.08	-	5
D2	.020	.053	0.51	1.35	
E	.602	.625	15.29	15.87	4
E1	.530	-	13.46	-	
E2	.178	.216	4.52	5.49	
e	.215 BSC		5.46 BSC		
Øk	.010		0.25		
L	.559	.634	14.20	16.10	
L1	.146	.169	3.71	4.29	
ØP	.140	.144	3.56	3.66	
ØP1	-	.291	-	7.39	
O	.209	.224	5.31	5.69	
S	.217 BSC		5.51 BSC		

LEAD ASSIGNMENTS

HEXFET

- 1.- GATE
- 2.- DRAIN
- 3.- SOURCE
- 4.- DRAIN

IGBTs, CoPACK

- 1.- GATE
- 2.- COLLECTOR
- 3.- EMITTER
- 4.- COLLECTOR

DIODES

- 1.- ANODE/OPEN
- 2.- CATHODE
- 3.- ANODE

TO-247AC Part Marking Information

EXAMPLE: THIS IS AN IRFP30
WITH ASSEMBLY
LOT CODE 5657
ASSEMBLED ON WW 35, 2001
IN THE ASSEMBLY LINE 'H'

Note: 'P' in assembly line position
indicates 'Lead-Free'

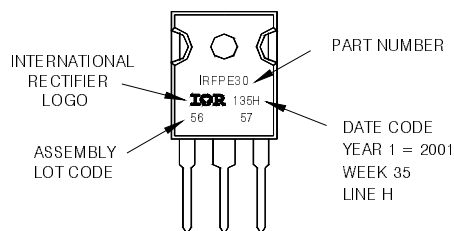

Note: For the most current drawing please refer to IR website at <http://www.irf.com/package/>

Data and specifications subject to change without notice.

单击下面可查看定价，库存，交付和生命周期等信息

[>>Infineon Technologies\(英飞凌\)](#)