

High speed switching series third generation IGBT

Low switching losses IGBT in Highspeed3 technology copacked with soft, fast recovery full current rated anti-parallel Emitter Controlled diode

Features:

High speed H3 technology offers:

- Ultra-low loss switching losses thanks to Kelvin emitter pin package in combination with High speed H3 technology
- High efficiency in hard switching and resonant topologies
- 10µsec short circuit withstand time at $T_{vj}=175^{\circ}\text{C}$
- Easy paralleling capability due to positive temperature coefficient in $V_{CE(sat)}$
- Low EMI
- Low Gate Charge Q_G
- Very soft, fast recovery full current anti-parallel diode
- Maximum junction temperature 175°C
- Pb-free lead plating; RoHS compliant
- Complete product spectrum and PSpice Models:
<http://www.infineon.com/igbt/>

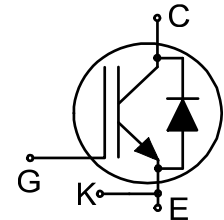

Applications:

- Industrial UPS
- Charger
- Energy Storage
- Three-level Solar String Inverter

Product Validation:

Qualified for industrial applications according to the relevant tests of JEDEC47/20/22



Key Performance and Package Parameters

Type	V_{CE}	I_C	$V_{CEsat}, T_{vj}=25^{\circ}\text{C}$	T_{vjmax}	Marking	Package
IKY50N120CH3	1200V	50A	2V	175°C	K50MCH3	PG-TO247-4-2

Table of Contents

Description	1
Table of Contents	2
Maximum Ratings	3
Thermal Resistance	3
Electrical Characteristics	4
Electrical Characteristics Diagrams	6
Package Drawing	13
Testing Conditions	14
Revision History	15
Disclaimer	16

High speed switching series third generation IGBT

Maximum Ratings

For optimum lifetime and reliability, Infineon recommends operating conditions that do not exceed 80% of the maximum ratings stated in this datasheet.

Parameter	Symbol	Value	Unit
Collector-emitter voltage, $T_{vj} \geq 25^{\circ}\text{C}$	V_{CE}	1200	V
DC collector current, limited by T_{vjmax} $T_c = 25^{\circ}\text{C}$ $T_c = 135^{\circ}\text{C}$	I_C	100.0 50.0	A
Pulsed collector current, t_p limited by T_{vjmax}	I_{Cpuls}	200.0	A
Turn off safe operating area $V_{CE} \leq 1200\text{V}$, $T_{vj} \leq 175^{\circ}\text{C}$, $t_p = 1\mu\text{s}$	-	200.0	A
Diode forward current, limited by T_{vjmax} $T_c = 25^{\circ}\text{C}$ $T_c = 100^{\circ}\text{C}$	I_F	100.0 50.0	A
Diode pulsed current, t_p limited by T_{vjmax}	I_{Fpuls}	200.0	A
Gate-emitter voltage Transient Gate-emitter voltage ($t_p \leq 10\mu\text{s}$, $D < 0.010$)	V_{GE}	± 20 ± 30	V
Short circuit withstand time $V_{GE} = 15.0\text{V}$, $V_{CC} \leq 600\text{V}$ Allowed number of short circuits < 1000 Time between short circuits: $\geq 1.0\text{s}$ $T_{vj} = 175^{\circ}\text{C}$	t_{SC}	10	μs
Power dissipation $T_c = 25^{\circ}\text{C}$ Power dissipation $T_c = 135^{\circ}\text{C}$	P_{tot}	652.0 173.0	W
Operating junction temperature	T_{vj}	-40...+175	$^{\circ}\text{C}$
Storage temperature	T_{stg}	-55...+150	$^{\circ}\text{C}$
Soldering temperature, wave soldering 1.6mm (0.063in.) from case for 10s		260	$^{\circ}\text{C}$

Thermal Resistance

Parameter	Symbol	Conditions	Value			Unit
			min.	typ.	max.	

 R_{th} Characteristics

IGBT thermal resistance, ¹⁾ junction - case	$R_{th(j-c)}$		-	-	0.23	K/W
Diode thermal resistance, ¹⁾ junction - case	$R_{th(j-c)}$		-	-	0.42	K/W
Thermal resistance junction - ambient	$R_{th(j-a)}$		-	-	40	K/W

¹⁾ Thermal resistance of thermal grease $R_{th(c-s)}$ (case to heat sink) of more than 0.1K/W not included.

High speed switching series third generation IGBT

Electrical Characteristic, at $T_{vj} = 25^{\circ}\text{C}$, unless otherwise specified

Parameter	Symbol	Conditions	Value			Unit
			min.	typ.	max.	
Static Characteristic						
Collector-emitter breakdown voltage	$V_{(BR)CES}$	$V_{GE} = 0\text{V}, I_C = 0.50\text{mA}$	1200	-	-	V
Collector-emitter saturation voltage	V_{CEsat}	$V_{GE} = 15.0\text{V}, I_C = 50.0\text{A}$ $T_{vj} = 25^{\circ}\text{C}$ $T_{vj} = 175^{\circ}\text{C}$	- -	2.00 2.50	2.35 -	V
Diode forward voltage	V_F	$V_{GE} = 0\text{V}, I_F = 50.0\text{A}$ $T_{vj} = 25^{\circ}\text{C}$ $T_{vj} = 175^{\circ}\text{C}$	- -	1.90 1.85	2.30 -	V
Gate-emitter threshold voltage	$V_{GE(th)}$	$I_C = 1.70\text{mA}, V_{CE} = V_{GE}$	5.1	5.8	6.5	V
Zero gate voltage collector current	I_{CES}	$V_{CE} = 1200\text{V}, V_{GE} = 0\text{V}$ $T_{vj} = 25^{\circ}\text{C}$ $T_{vj} = 175^{\circ}\text{C}$	- -	- 4000	350 -	μA
Gate-emitter leakage current	I_{GES}	$V_{CE} = 0\text{V}, V_{GE} = 20\text{V}$	-	-	100	nA
Transconductance	g_{fs}	$V_{CE} = 20\text{V}, I_C = 50.0\text{A}$	-	17.0	-	S

Electrical Characteristic, at $T_{vj} = 25^{\circ}\text{C}$, unless otherwise specified

Parameter	Symbol	Conditions	Value			Unit
			min.	typ.	max.	
Dynamic Characteristic						
Input capacitance	C_{ies}	$V_{CE} = 25\text{V}, V_{GE} = 0\text{V}, f = 1\text{MHz}$	-	3269	-	pF
Output capacitance	C_{oes}		-	355	-	
Reverse transfer capacitance	C_{res}		-	199	-	
Gate charge	Q_G	$V_{CC} = 960\text{V}, I_C = 50.0\text{A},$ $V_{GE} = 15\text{V}$	-	235.0	-	nC
Internal emitter inductance measured 5mm (0.197 in.) from case	L_E		-	13.0	-	nH

Switching Characteristic, Inductive Load

Parameter	Symbol	Conditions	Value			Unit
			min.	typ.	max.	
IGBT Characteristic, at $T_{vj} = 25^{\circ}\text{C}$						
Turn-on delay time	$t_{d(on)}$	$T_{vj} = 25^{\circ}\text{C},$ $V_{CC} = 600\text{V}, I_C = 50.0\text{A},$ $V_{GE} = 0.0/15.0\text{V},$ $R_{G(on)} = 10.0\Omega, R_{G(off)} = 10.0\Omega,$ $L_{\sigma} = 90\text{nH}, C_{\sigma} = 67\text{pF}$ L_{σ}, C_{σ} from Fig. E Energy losses include "tail" and diode reverse recovery.	-	32	-	ns
Rise time	t_r		-	28	-	ns
Turn-off delay time	$t_{d(off)}$		-	296	-	ns
Fall time	t_f		-	29	-	ns
Turn-on energy	E_{on}		-	2.30	-	mJ
Turn-off energy	E_{off}		-	1.90	-	mJ
Total switching energy	E_{ts}		-	4.20	-	mJ

High speed switching series third generation IGBT

Diode Characteristic, at $T_{vj} = 25^{\circ}\text{C}$

Diode reverse recovery time	t_{rr}	$T_{vj} = 25^{\circ}\text{C}$, $V_R = 600\text{V}$, $I_F = 50.0\text{A}$, $di_F/dt = 1200\text{A}/\mu\text{s}$	-	255	-	ns
Diode reverse recovery charge	Q_{rr}		-	3.40	-	μC
Diode peak reverse recovery current	I_{rrm}		-	33.0	-	A
Diode peak rate of fall of reverse recovery current during t_b	di_{rr}/dt		-	-620	-	$\text{A}/\mu\text{s}$

Switching Characteristic, Inductive Load

Parameter	Symbol	Conditions	Value			Unit
			min.	typ.	max.	

IGBT Characteristic, at $T_{vj} = 175^{\circ}\text{C}$

Turn-on delay time	$t_{d(on)}$	$T_{vj} = 175^{\circ}\text{C}$, $V_{CC} = 600\text{V}$, $I_C = 50.0\text{A}$, $V_{GE} = 0.0/15.0\text{V}$, $R_{G(on)} = 10.0\Omega$, $R_{G(off)} = 10.0\Omega$, $L\sigma = 90\text{nH}$, $C\sigma = 67\text{pF}$ $L\sigma$, $C\sigma$ from Fig. E Energy losses include "tail" and diode reverse recovery.	-	31	-	ns
Rise time	t_r		-	31	-	ns
Turn-off delay time	$t_{d(off)}$		-	397	-	ns
Fall time	t_f		-	65	-	ns
Turn-on energy	E_{on}		-	4.30	-	mJ
Turn-off energy	E_{off}		-	4.00	-	mJ
Total switching energy	E_{ts}		-	8.30	-	mJ

Diode Characteristic, at $T_{vj} = 175^{\circ}\text{C}$

Diode reverse recovery time	t_{rr}	$T_{vj} = 175^{\circ}\text{C}$, $V_R = 600\text{V}$, $I_F = 50.0\text{A}$, $di_F/dt = 1200\text{A}/\mu\text{s}$	-	370	-	ns
Diode reverse recovery charge	Q_{rr}		-	8.80	-	μC
Diode peak reverse recovery current	I_{rrm}		-	52.0	-	A
Diode peak rate of fall of reverse recovery current during t_b	di_{rr}/dt		-	-460	-	$\text{A}/\mu\text{s}$

High speed switching series third generation IGBT

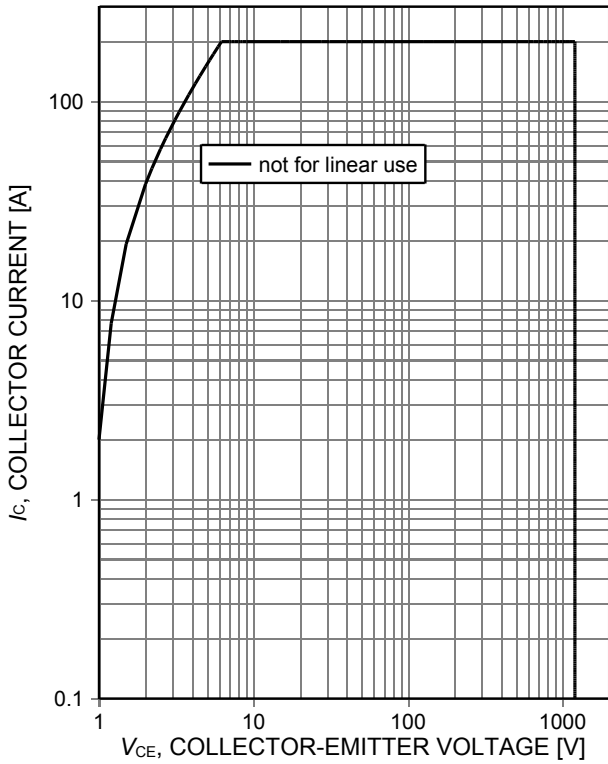

Figure 1. **Forward bias safe operating area**
($D=0$, $T_C=25^\circ\text{C}$, $T_{vj}\leq 175^\circ\text{C}$; $V_{GE}=15\text{V}$)

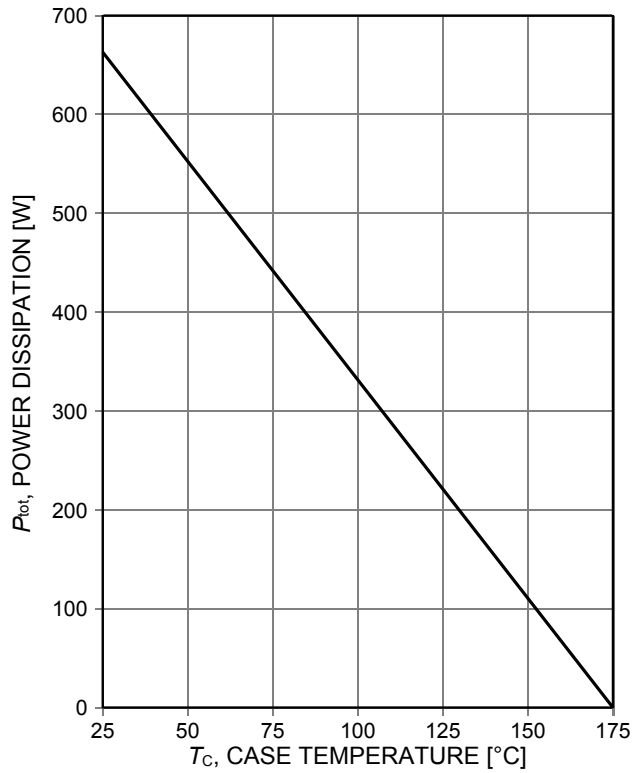

Figure 2. **Power dissipation as a function of case temperature**
($T_{vj}\leq 175^\circ\text{C}$)

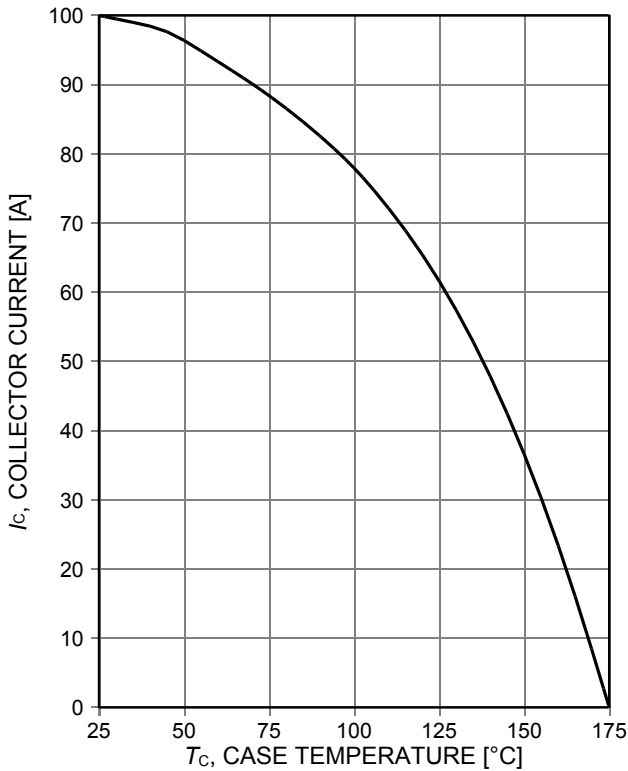

Figure 3. **Collector current as a function of case temperature**
($V_{GE}\geq 15\text{V}$, $T_{vj}\leq 175^\circ\text{C}$)

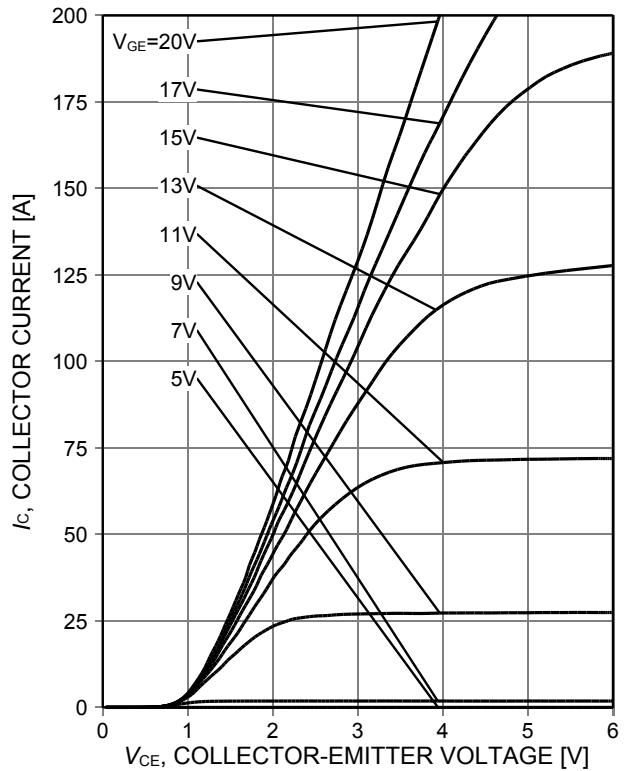

Figure 4. **Typical output characteristic**
($T_{vj}=25^\circ\text{C}$)

High speed switching series third generation IGBT

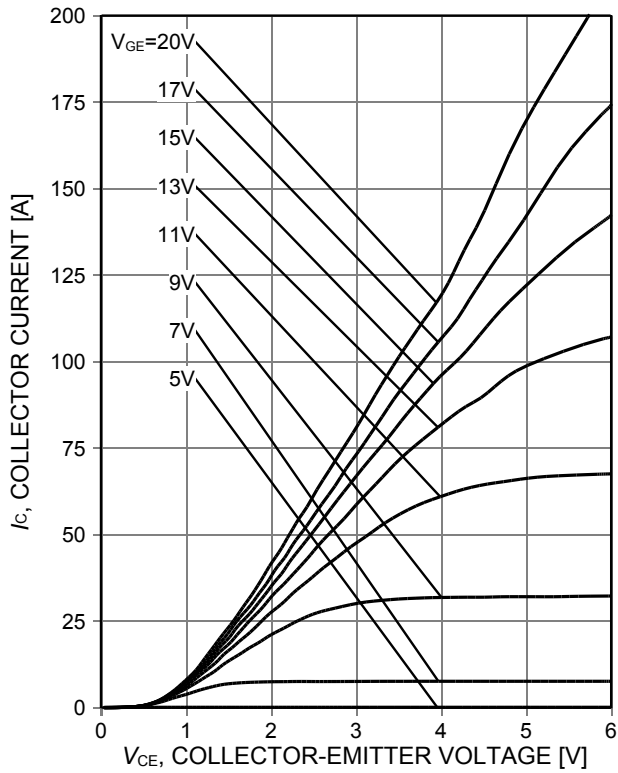

Figure 5. Typical output characteristic ($T_{vj}=175^{\circ}\text{C}$)

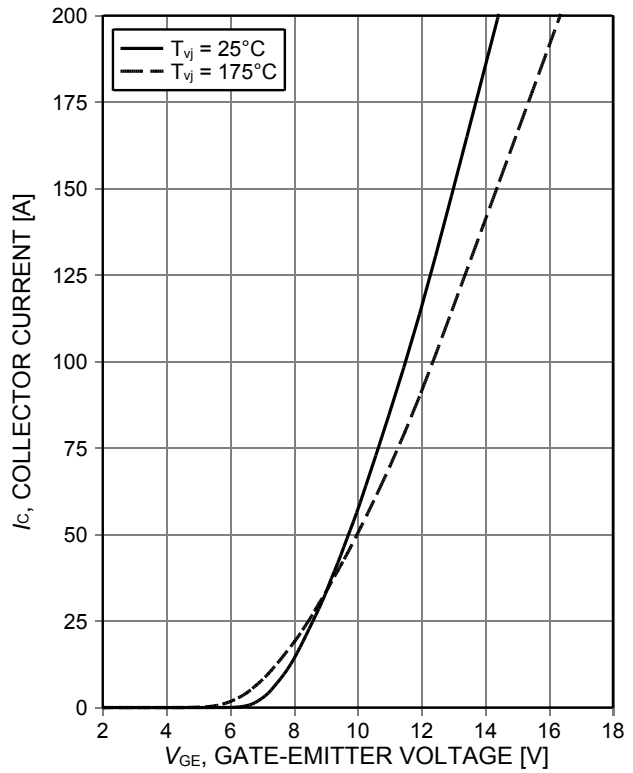

Figure 6. Typical transfer characteristic ($V_{ce}=20\text{V}$)

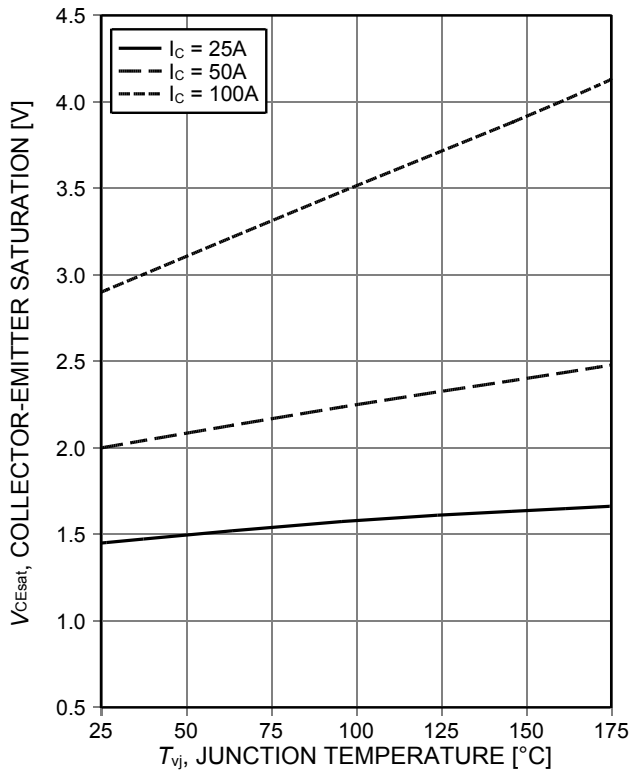

Figure 7. Typical collector-emitter saturation voltage as a function of junction temperature ($V_{ge}=15\text{V}$)

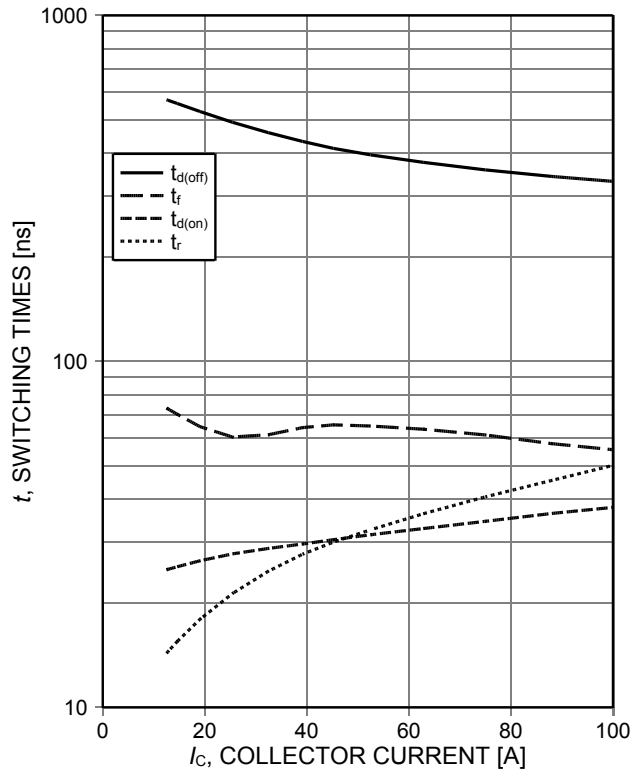

Figure 8. Typical switching times as a function of collector current (inductive load, $T_{vj}=175^{\circ}\text{C}$, $V_{ce}=600\text{V}$, $V_{ge}=0/15\text{V}$, $R_G=10\Omega$, Dynamic test circuit in Figure E)

High speed switching series third generation IGBT

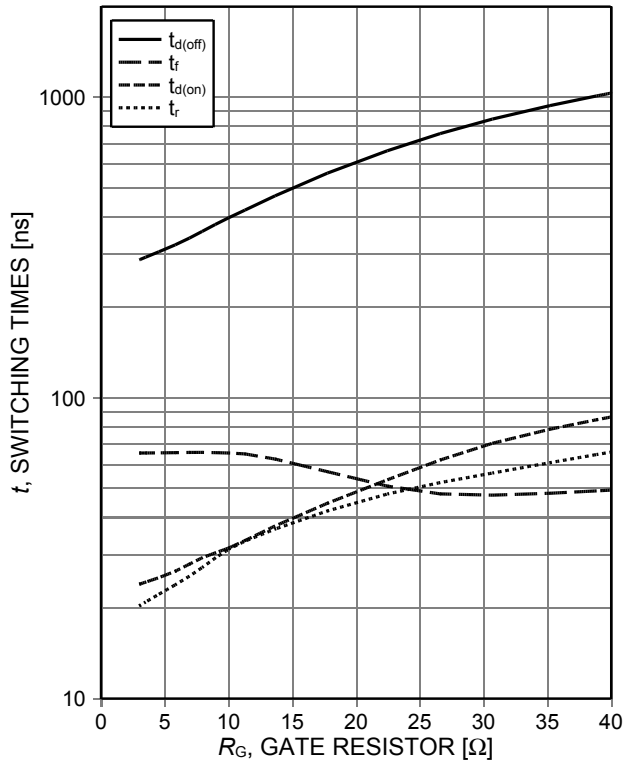

Figure 9. Typical switching times as a function of gate resistor (inductive load, $T_{vj}=175^\circ\text{C}$, $V_{CE}=600\text{V}$, $V_{GE}=0/15\text{V}$, $I_C=50\text{A}$, Dynamic test circuit in Figure E)

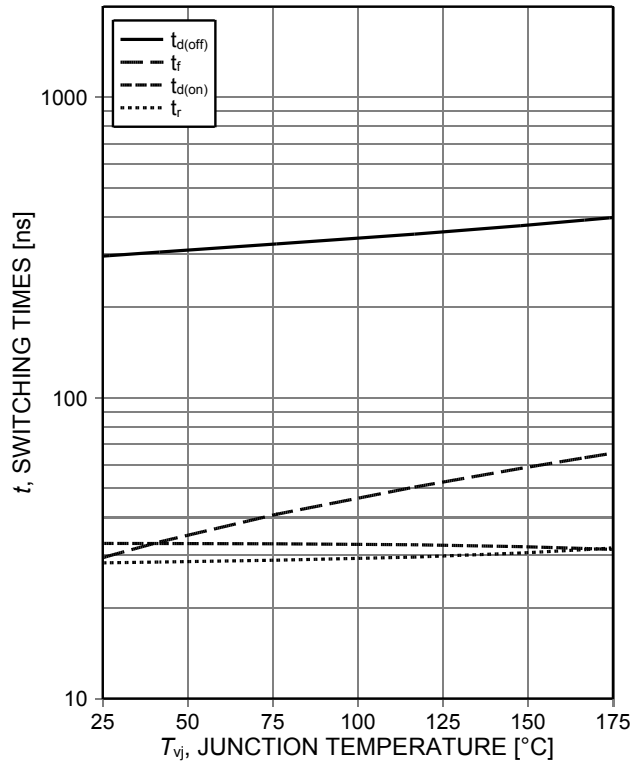

Figure 10. Typical switching times as a function of junction temperature (inductive load, $V_{CE}=600\text{V}$, $V_{GE}=0/15\text{V}$, $I_C=50\text{A}$, $R_G=10\Omega$, Dynamic test circuit in Figure E)

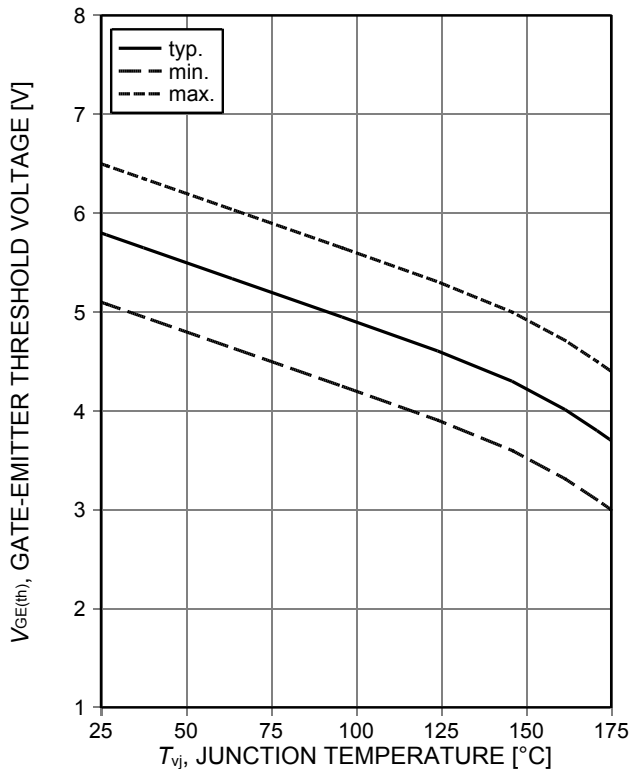

Figure 11. Gate-emitter threshold voltage as a function of junction temperature ($I_C=1.7\text{ mA}$)

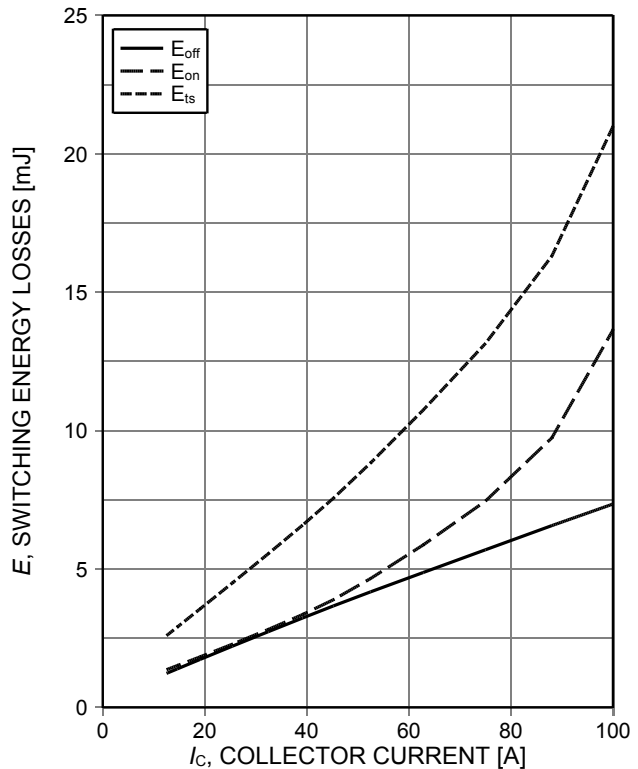

Figure 12. Typical switching energy losses as a function of collector current (inductive load, $T_{vj}=175^\circ\text{C}$, $V_{CE}=600\text{V}$, $V_{GE}=0/15\text{V}$, $R_G=10\Omega$, Dynamic test circuit in Figure E)

High speed switching series third generation IGBT

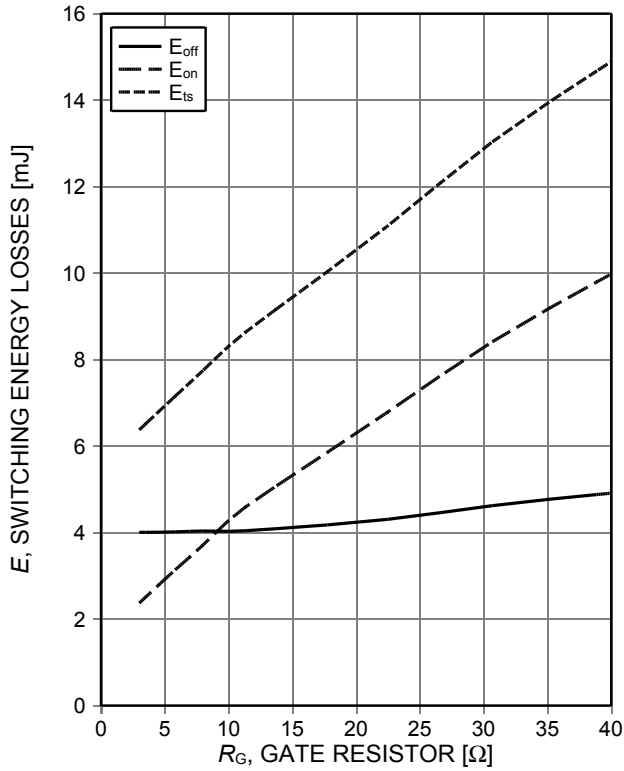

Figure 13. **Typical switching energy losses as a function of gate resistor**
 (inductive load, $T_{vj}=175^{\circ}\text{C}$, $V_{CE}=600\text{V}$, $V_{GE}=0/15\text{V}$, $I_C=50\text{A}$, Dynamic test circuit in Figure E)

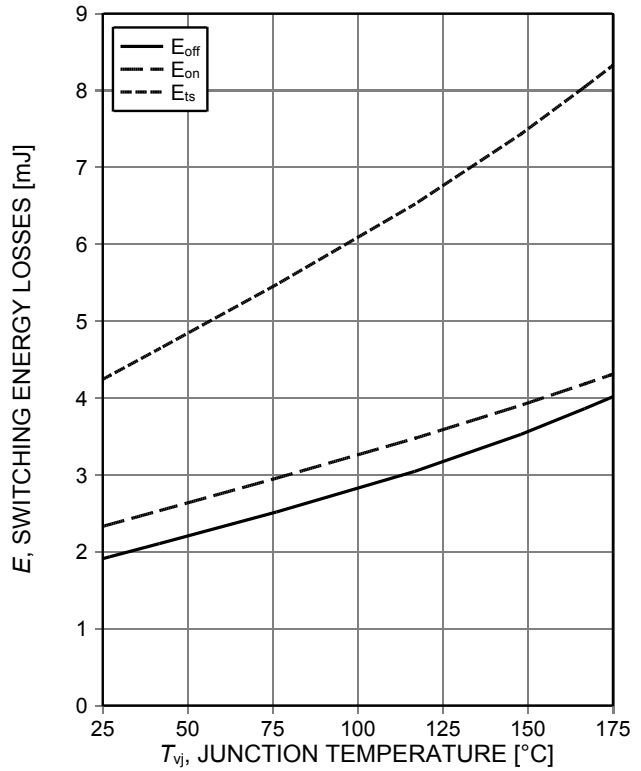

Figure 14. **Typical switching energy losses as a function of junction temperature**
 (inductive load, $V_{CE}=600\text{V}$, $V_{GE}=0/15\text{V}$, $I_C=50\text{A}$, $R_G=10\Omega$, Dynamic test circuit in Figure E)

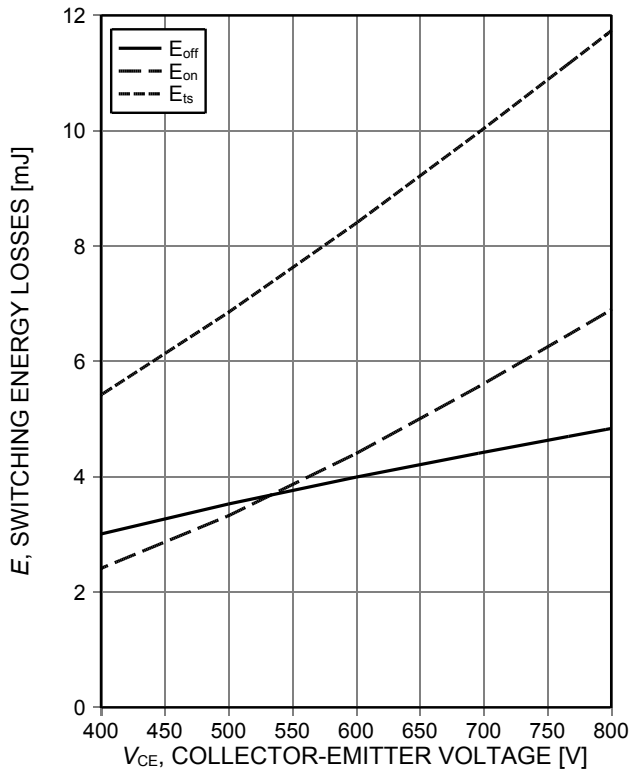

Figure 15. **Typical switching energy losses as a function of collector emitter voltage**
 (inductive load, $T_{vj}=175^{\circ}\text{C}$, $V_{GE}=0/15\text{V}$, $I_C=50\text{A}$, $R_G=10\Omega$, Dynamic test circuit in Figure E)

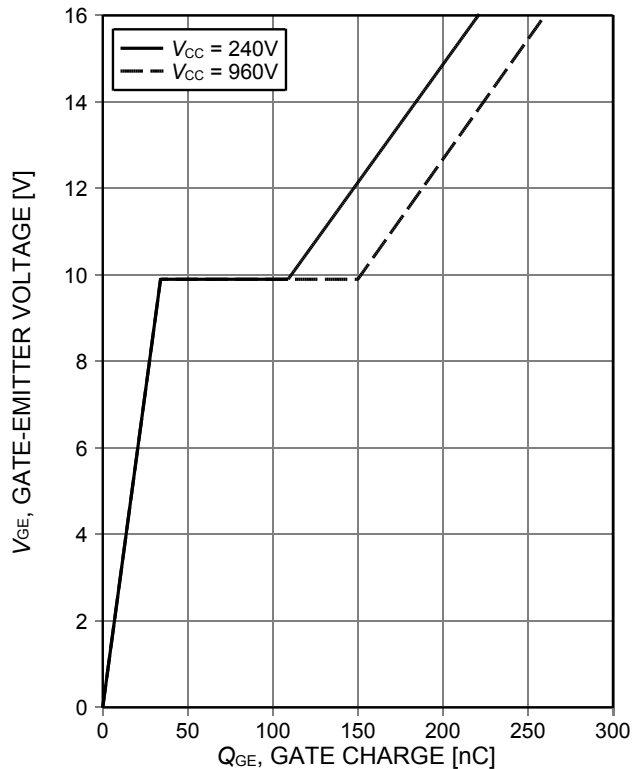

Figure 16. **Typical gate charge**
 ($I_C=50\text{A}$)

High speed switching series third generation IGBT

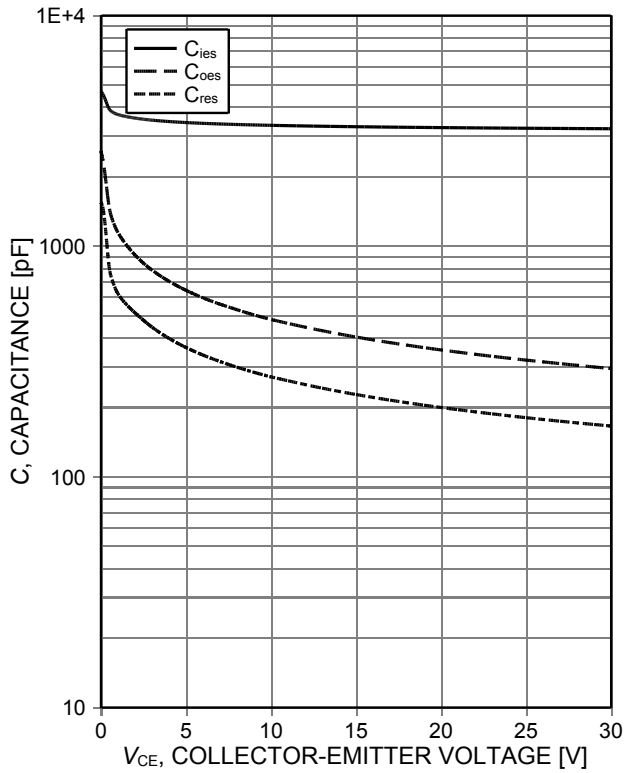

Figure 17. Typical capacitance as a function of collector-emitter voltage ($V_{GE}=0V$, $f=1MHz$)

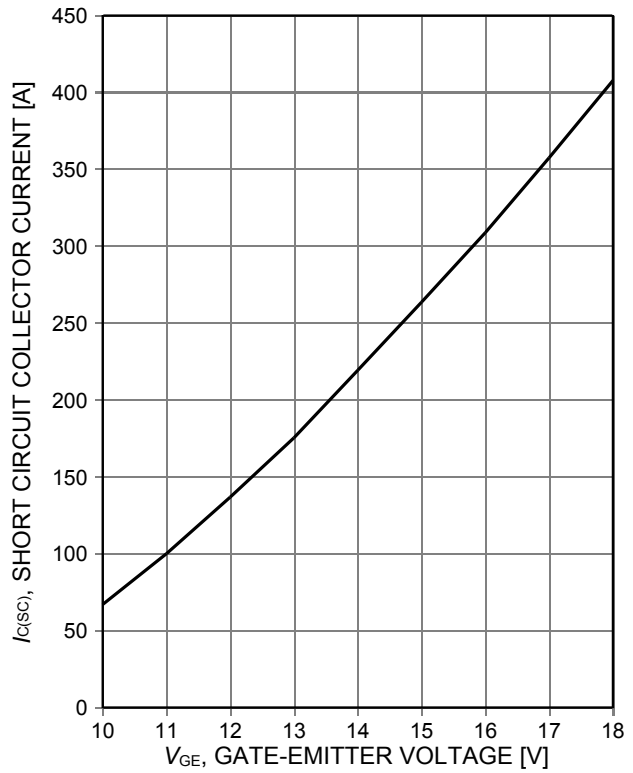

Figure 18. Typical short circuit collector current as a function of gate-emitter voltage ($V_{CE}\leq 600V$, $T_{vj}\leq 175^{\circ}C$)

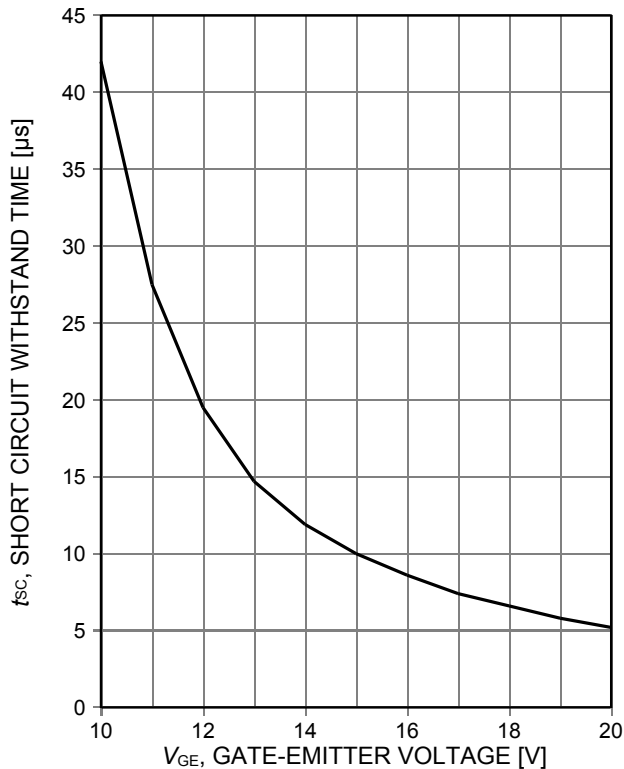

Figure 19. Short circuit withstand time as a function of gate-emitter voltage ($V_{CE}\leq 600V$, start at $T_{vj}\leq 175^{\circ}C$)

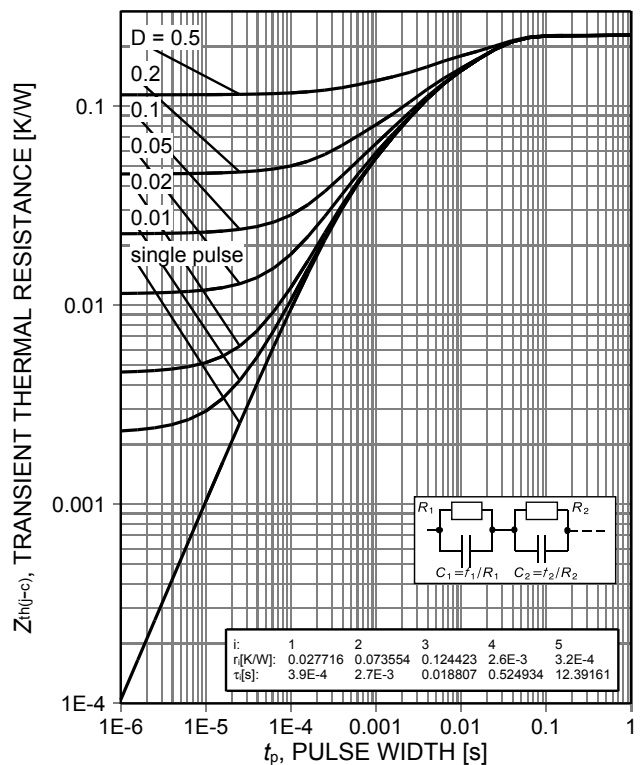

Figure 20. IGBT transient thermal resistance ($D=t_p/T$)

High speed switching series third generation IGBT

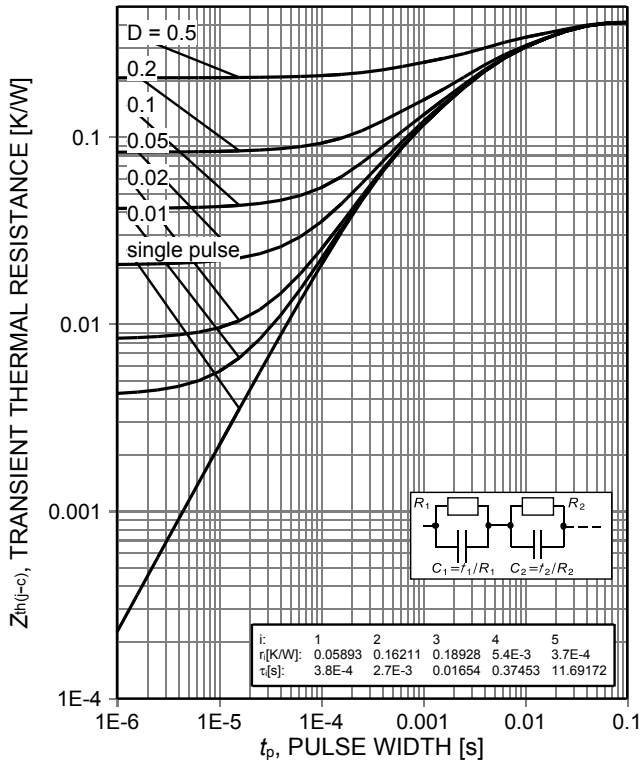

Figure 21. Diode transient thermal impedance as a function of pulse width ($D = t_p/T$)

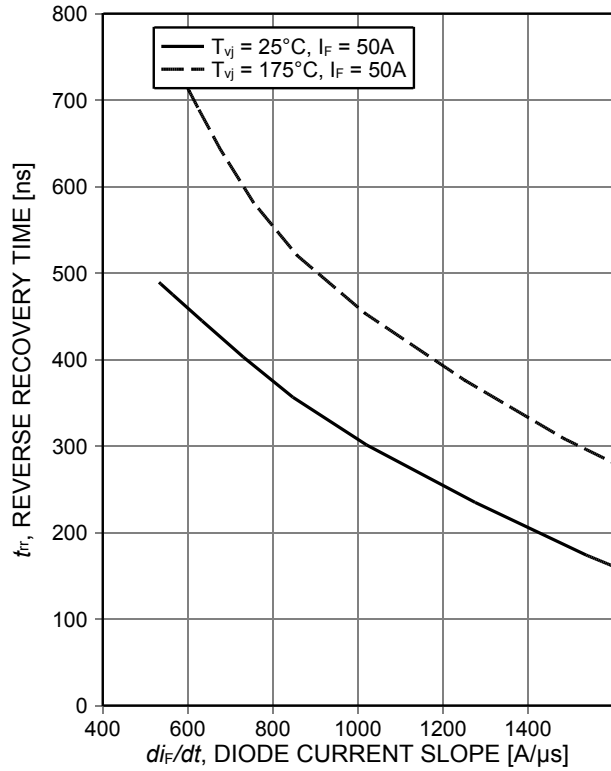

Figure 22. Typical reverse recovery time as a function of diode current slope ($V_R = 600V$)

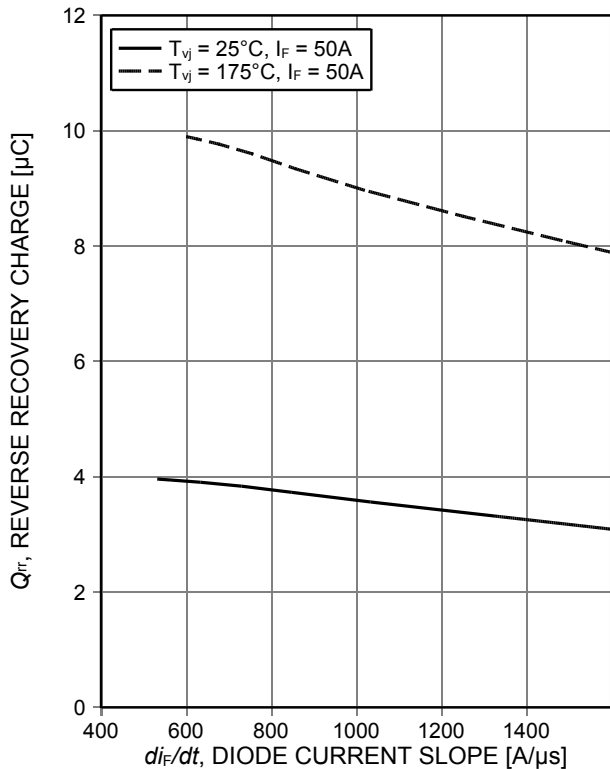

Figure 23. Typical reverse recovery charge as a function of diode current slope ($V_R = 600V$)

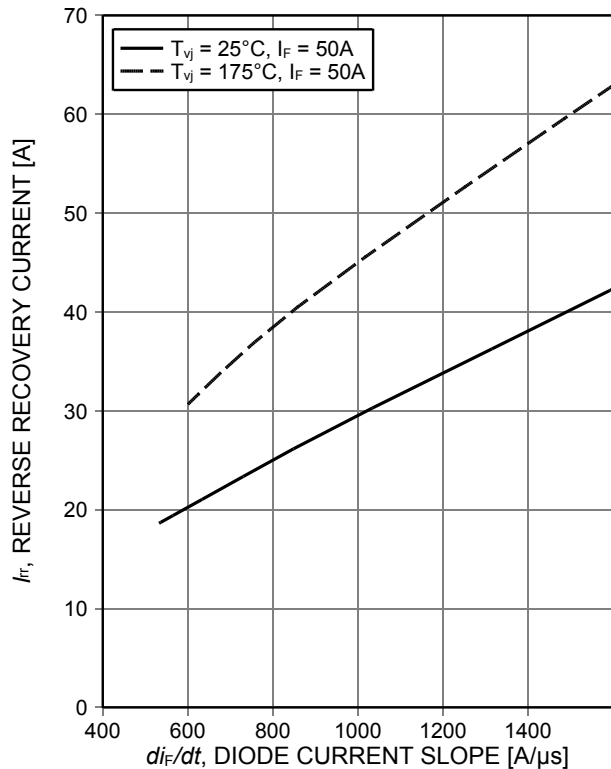

Figure 24. Typical reverse recovery current as a function of diode current slope ($V_R = 600V$)

High speed switching series third generation IGBT

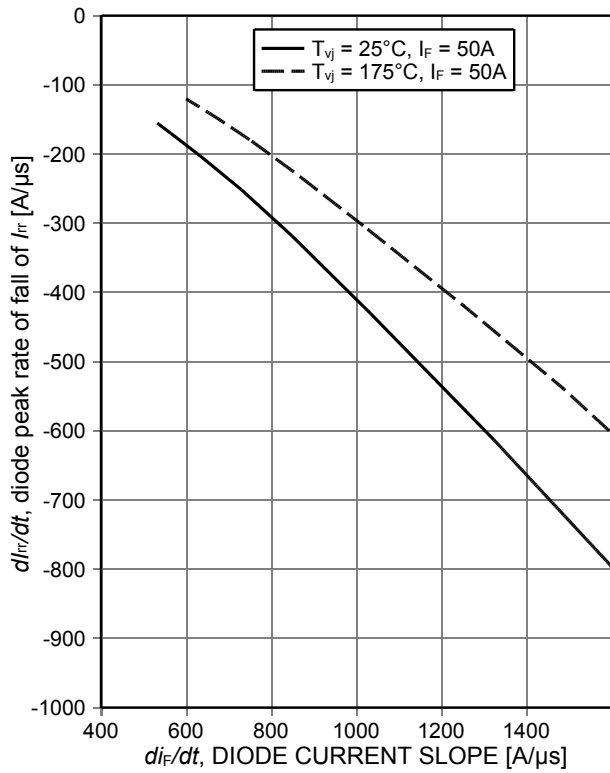

Figure 25. Typical diode peak rate of fall of reverse recovery current as a function of diode current slope (VR=600V)

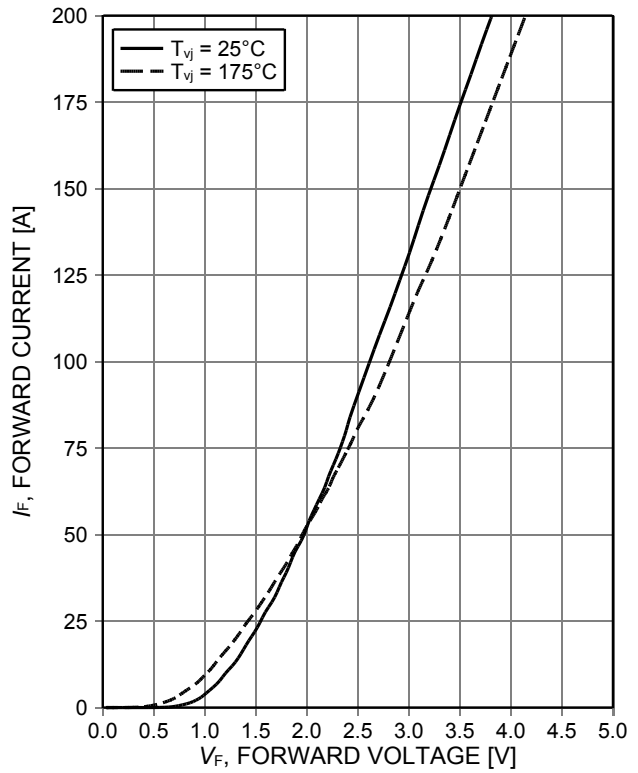

Figure 26. Typical diode forward current as a function of forward voltage

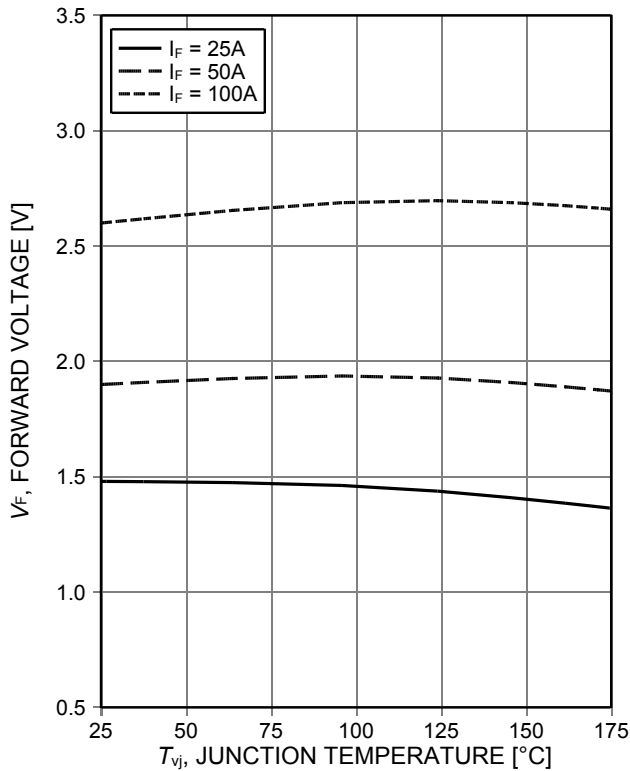
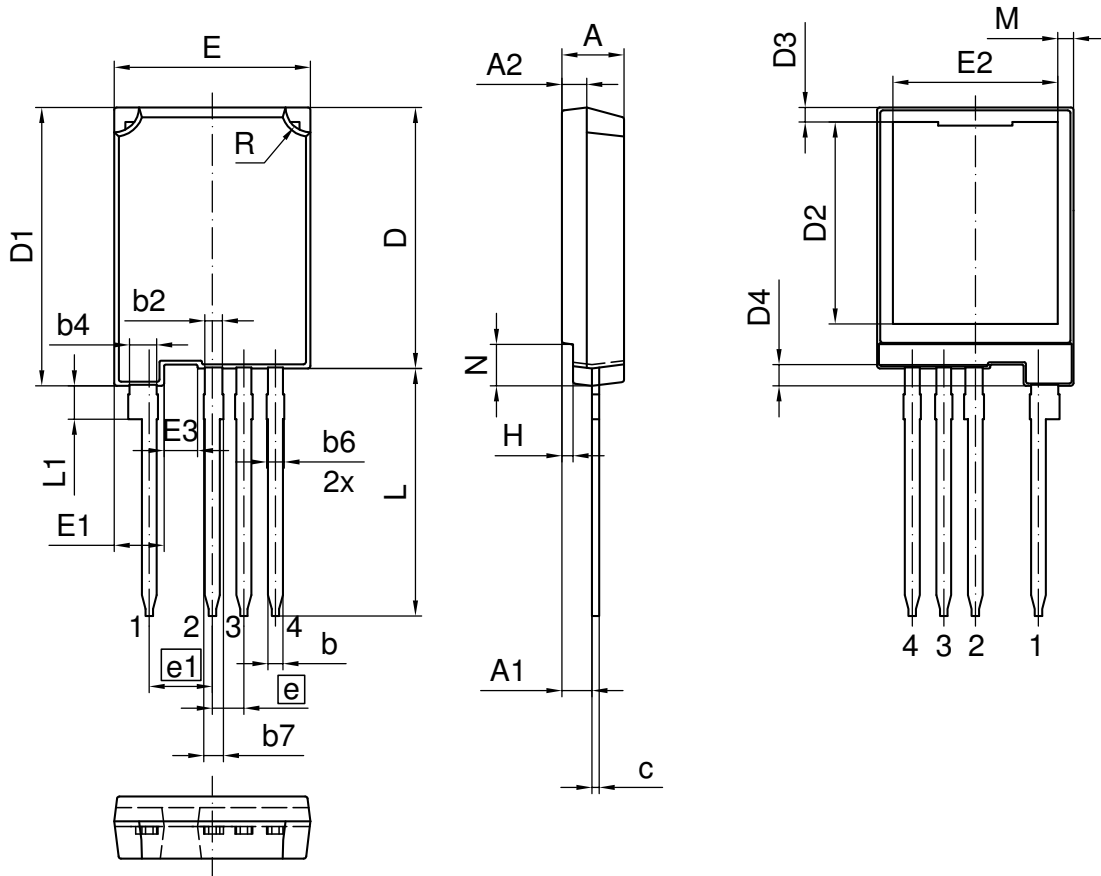

Figure 27. Typical diode forward voltage as a function of junction temperature

PG-TO247-4-2



NOTES:

PACKAGE SURFACE ROUTE BETWEEN PIN 1 & PIN 2 WILL BE 5.1mm MIN.

ALL b... AND c DIMENSIONS INCLUDING PLATING EXCEPT AREA OF CUTTING

DIMENSION	MILLIMETERS	
	MIN.	MAX.
A	4.9	5.1
A1	2.31	2.51
A2	1.9	2.1
b	1.16	1.29
b2	1.36	1.49
b4	2.16	2.29
b6	1.16	1.45
b7	1.16	1.65
c	0.59	0.66
D	20.9	21.1
D1	22.3	22.5
D2	15.95	16.55
D3	1	1.35
D4	1.6	1.8
E	15.7	15.9
E1	3.9	4.1
E2	13.1	13.5
E3	2.58	2.78
e	2.54	
e1	5.08	
H	0.8	1
L	19.8	20.1
L1	2.55	2.85
M	0.97	1.57
N	3.24	3.44
R	1.9	2.1

DOCUMENT NO. Z8B00182798
REVISION 01
SCALE 2:1
EUROPEAN PROJECTION
ISSUE DATE 23.09.2016

High speed switching series third generation IGBT

Testing Conditions

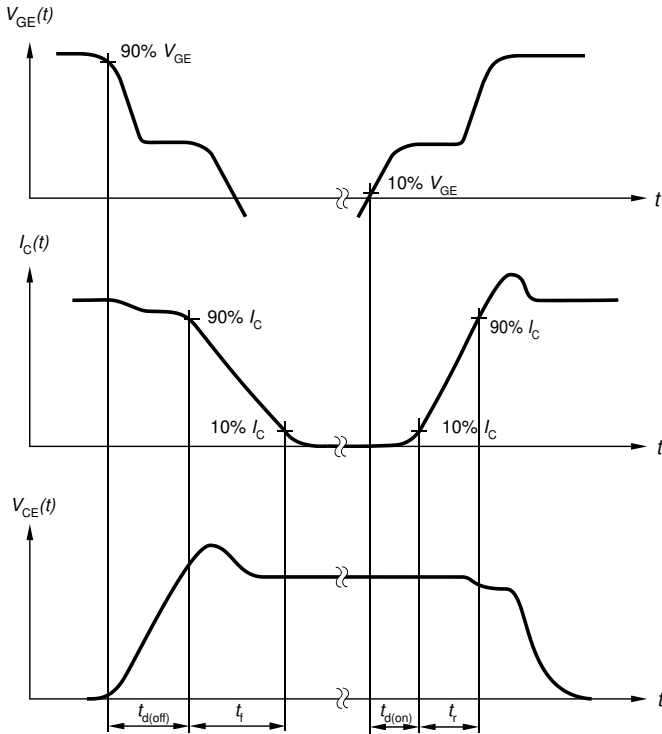

Figure A. Definition of switching times

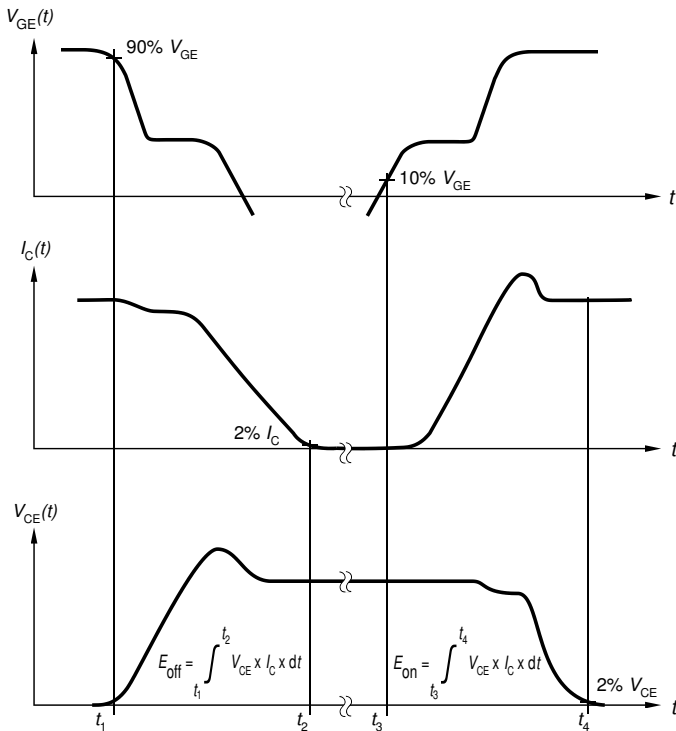

Figure B. Definition of switching losses

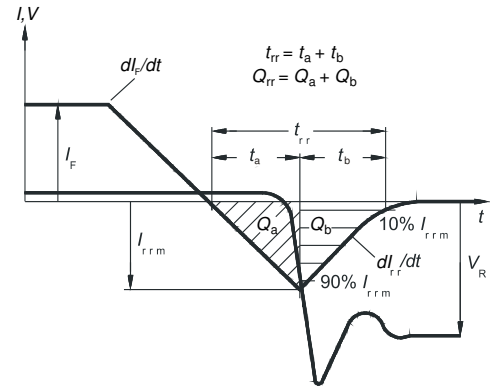

Figure C. Definition of diode switching characteristics

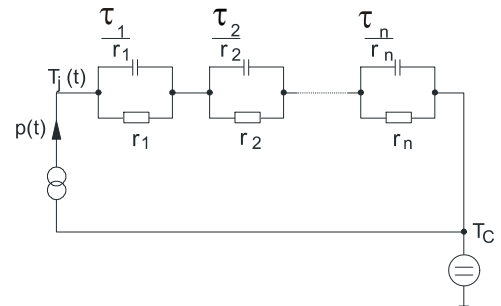

Figure D. Thermal equivalent circuit

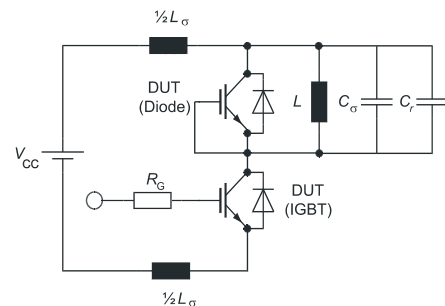

Figure E. Dynamic test circuit
Parasitic inductance L_{σ} ,
parasitic capacitor C_{σ} ,
relief capacitor C_r ,
(only for ZVT switching)

Revision History

IKY50N120CH3

Revision: 2019-04-15, Rev. 2.3

Previous Revision

Revision	Date	Subjects (major changes since last revision)
2.1	2017-04-26	Final data sheet
2.2	2017-06-09	Update Figure 26
2.3	2019-04-15	Update condition for V _{geth} page 4 and Fig. 11

Trademarks

All referenced product or service names and trademarks are the property of their respective owners.

Published by
Infineon Technologies AG
81726 München, Germany
© Infineon Technologies AG 2019.
All Rights Reserved.

Important Notice

The information given in this document shall in no event be regarded as a guarantee of conditions or characteristics ("Beschaffenheitsgarantie"). With respect to any examples, hints or any typical values stated herein and/or any information regarding the application of the product, Infineon Technologies hereby disclaims any and all warranties and liabilities of any kind, including without limitation warranties of non-infringement of intellectual property rights of any third party.

In addition, any information given in this document is subject to customer's compliance with its obligations stated in this document and any applicable legal requirements, norms and standards concerning customer's products and any use of the product of Infineon Technologies in customer's applications.

The data contained in this document is exclusively intended for technically trained staff. It is the responsibility of customer's technical departments to evaluate the suitability of the product for the intended application and the completeness of the product information given in this document with respect to such application.

For further information on the product, technology, delivery terms and conditions and prices please contact your nearest Infineon Technologies office (www.infineon.com).

Please note that this product is not qualified according to the AEC Q100 or AEC Q101 documents of the Automotive Electronics Council.

Warnings

Due to technical requirements products may contain dangerous substances. For information on the types in question please contact your nearest Infineon Technologies office.

Except as otherwise explicitly approved by Infineon Technologies in a written document signed by authorized representatives of Infineon Technologies, Infineon Technologies' products may not be used in any applications where a failure of the product or any consequences of the use thereof can reasonably be expected to result in personal injury.

单击下面可查看定价，库存，交付和生命周期等信息

[>>Infineon Technologies\(英飞凌\)](#)