

Short circuit rugged 1200 V TRENCHSTOP™ IGBT 7 technology copacked with soft, fast recovery Emitter Controlled 7 diode

Features

- $V_{CE} = 1200\text{ V}$
- $I_C = 100\text{ A}$
- IGBT co-packed with full current, soft and low Q_{rr} diode
- Low saturation voltage $V_{CEsat} = 2.0\text{ V}$ at $T_{vj} = 175^\circ\text{C}$
- Optimized for hard switching topologies (2-L inverter, 3-L NPC T-type, ...)
- Short circuit ruggedness $8\ \mu\text{s}$
- Wide range of dv/dt controllability
- Complete product spectrum and PSpice Models: <http://www.infineon.com/igbt/>

Potential applications

- Industrial drives
- Industrial power supplies
- Solar inverters

Product validation

- Qualified for industrial applications according to the relevant tests of JEDEC47/20/22

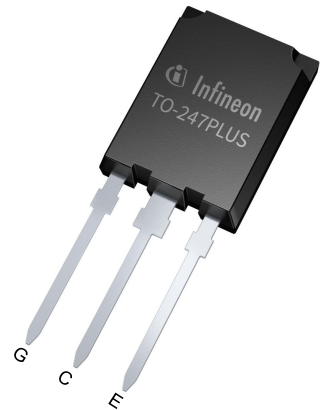

- Halogen-free
- Lead-free
- Green
- RoHS

Description

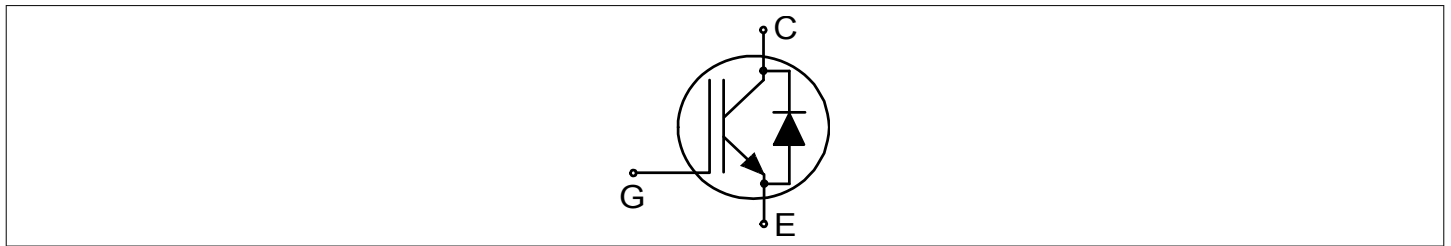

Type	Package	Marking
IKQ100N120CS7	PG-TO247-3-PLUS-NN3.7	K100MCS7

Table of contents

	Description	1
	Features	1
	Potential applications	1
	Product validation	1
	Table of contents	2
1	Package	3
2	IGBT	3
3	Diode	5
4	Characteristics diagrams	7
5	Package outlines	14
6	Testing conditions	15
	Revision history	16
	Disclaimer	17

1 Package

Table 1 Characteristic values

Parameter	Symbol	Note or test condition	Values			Unit
			Min.	Typ.	Max.	
Internal emitter inductance measured 5 mm (0.197 in.) from case	L_E			13		nH
Storage temperature	T_{stg}		-55		150	°C
Soldering temperature	T_{sold}	wave soldering 1.6 mm (0.063 in.) from case for 10 s			260	°C
Thermal resistance, junction-ambient	$R_{th(j-a)}$				40	K/W
IGBT thermal resistance, junction-case	$R_{th(j-c)}$			0.13	0.18	K/W
Diode thermal resistance, junction-case	$R_{th(j-c)}$			0.24	0.33	K/W

2 IGBT

Table 2 Maximum rated values

Parameter	Symbol	Note or test condition	Values	Unit	
Collector-emitter voltage	V_{CE}	$T_{vj} \geq 25\text{ °C}$	1200	V	
DC collector current, limited by T_{vjmax}	I_C	limited by bondwire	$T_c = 25\text{ °C}$	188	A
			$T_c = 100\text{ °C}$	126	
Pulsed collector current, t_p limited by T_{vjmax}	I_{Cpulse}		300	A	
Turn-off safe operating area		$V_{CE} \leq 1200\text{ V}, T_{vj} \leq 175\text{ °C}$	300	A	
Gate-emitter voltage	V_{GE}		± 20	V	
Transient gate-emitter voltage	V_{GE}	$t_p \leq 0.5\text{ }\mu\text{s}, D < 0.001$	± 25	V	
Short-circuit withstand time	t_{SC}	$V_{CC} \leq 600\text{ V}, V_{GE} = 15\text{ V}$, Allowed number of short circuits < 1000, Time between short circuits $\geq 1.0\text{ s}, T_{vj} = 150\text{ °C}$	8	μs	
Power dissipation	P_{tot}	$T_{vj} \leq 175\text{ °C}$	$T_c = 25\text{ °C}$	824	W
			$T_c = 100\text{ °C}$	412	

Table 3 Characteristic values

Parameter	Symbol	Note or test condition	Values			Unit
			Min.	Typ.	Max.	
Collector-emitter saturation voltage	V_{CEsat}	$I_C = 100\text{ A}, V_{GE} = 15\text{ V}$	$T_{vj} = 25\text{ °C}$	1.65	2	V
			$T_{vj} = 175\text{ °C}$		2	
Gate-emitter threshold voltage	V_{GETh}	$I_C = 2\text{ mA}, V_{CE} = V_{GE}$	5.1	5.7	6.5	V
Zero gate-voltage collector current	I_{CES}	$V_{CE} = 1200\text{ V}, V_{GE} = 0\text{ V}$	$T_{vj} = 25\text{ °C}$		40	μA
			$T_{vj} = 175\text{ °C}$		8700	
Gate-emitter leakage current	I_{GES}	$V_{CE} = 0\text{ V}, V_{GE} = 20\text{ V}$			100	nA
Transconductance	g_{fs}	$I_C = 100\text{ A}, V_{CE} = 20\text{ V}, T_{vj} = 175\text{ °C}$		36		S
Short-circuit collector current	I_{SC}	$V_{CC} \leq 600\text{ V}, V_{GE} = 15\text{ V}, t_{SC} \leq 8\text{ }\mu\text{s}$, Allowed number of short circuits < 1000, Time between short circuits $\geq 1.0\text{ s}$		600		A
Input capacitance	C_{ies}	$V_{CE} = 25\text{ V}, V_{GE} = 0\text{ V}, f = 100\text{ kHz}$		14.5		nF
Output capacitance	C_{oes}	$V_{CE} = 25\text{ V}, V_{GE} = 0\text{ V}, f = 100\text{ kHz}$		270		pF
Reverse transfer capacitance	C_{res}	$V_{CE} = 25\text{ V}, V_{GE} = 0\text{ V}, f = 100\text{ kHz}$		60		pF
Gate charge	Q_G	$I_C = 100\text{ A}, V_{GE} = 15\text{ V}, V_{CC} = 960\text{ V}$		610		nC
Turn-on delay time	$t_{d(on)}$	$V_{CC} = 600\text{ V}, V_{GE} = 0/15\text{ V}, R_{G(on)} = 1.6\text{ }\Omega, R_{G(off)} = 1.6\text{ }\Omega$	$T_{vj} = 25\text{ °C}, I_C = 100\text{ A}$	38		ns
			$T_{vj} = 175\text{ °C}, I_C = 100\text{ A}$		39	
Rise time (inductive load)	t_r	$V_{CC} = 600\text{ V}, V_{GE} = 0/15\text{ V}, R_{G(on)} = 1.6\text{ }\Omega, R_{G(off)} = 1.6\text{ }\Omega$	$T_{vj} = 25\text{ °C}, I_C = 100\text{ A}$	26		ns
			$T_{vj} = 175\text{ °C}, I_C = 100\text{ A}$		29	
Turn-off delay time	$t_{d(off)}$	$V_{CC} = 600\text{ V}, V_{GE} = 0/15\text{ V}, R_{G(on)} = 1.6\text{ }\Omega, R_{G(off)} = 1.6\text{ }\Omega$	$T_{vj} = 25\text{ °C}, I_C = 100\text{ A}$	200		ns
			$T_{vj} = 175\text{ °C}, I_C = 100\text{ A}$		270	
Fall time (inductive load)	t_f	$V_{CC} = 600\text{ V}, V_{GE} = 0/15\text{ V}, R_{G(on)} = 1.6\text{ }\Omega, R_{G(off)} = 1.6\text{ }\Omega$	$T_{vj} = 25\text{ °C}, I_C = 100\text{ A}$	103		ns
			$T_{vj} = 175\text{ °C}, I_C = 100\text{ A}$		230	
Turn-on energy	E_{on}	$V_{CC} = 600\text{ V}, V_{GE} = 0/15\text{ V}, R_{G(on)} = 1.6\text{ }\Omega, R_{G(off)} = 1.6\text{ }\Omega$	$T_{vj} = 25\text{ °C}, I_C = 100\text{ A}$	6.87		mJ
			$T_{vj} = 175\text{ °C}, I_C = 100\text{ A}$		10.1	

(table continues...)

Table 3 (continued) Characteristic values

Parameter	Symbol	Note or test condition	Values			Unit	
			Min.	Typ.	Max.		
Turn-off energy	E_{off}	$V_{CC} = 600\text{ V}, V_{GE} = 0/15\text{ V},$ $R_{G(on)} = 1.6\ \Omega,$ $R_{G(off)} = 1.6\ \Omega$	$T_{vj} = 25\text{ }^\circ\text{C},$ $I_C = 100\text{ A}$		4.71		mJ
			$T_{vj} = 175\text{ }^\circ\text{C},$ $I_C = 100\text{ A}$		8.84		
Total switching energy	E_{ts}	$V_{CC} = 600\text{ V}, V_{GE} = 0/15\text{ V},$ $R_{G(on)} = 1.6\ \Omega,$ $R_{G(off)} = 1.6\ \Omega$	$T_{vj} = 25\text{ }^\circ\text{C},$ $I_C = 100\text{ A}$		11.6		mJ
			$T_{vj} = 175\text{ }^\circ\text{C},$ $I_C = 100\text{ A}$		18.9		
Operating junction temperature	T_{vj}		-40		175	$^\circ\text{C}$	

Note: Electrical Characteristic, at $T_{vj} = 25^\circ\text{C}$, unless otherwise specified.

3 Diode

Table 4 Maximum rated values

Parameter	Symbol	Note or test condition	Values	Unit	
Diode forward current, limited by T_{vjmax}	I_F	limited by bondwire	$T_c = 25\text{ }^\circ\text{C}$	155	A
			$T_c = 100\text{ }^\circ\text{C}$	101	
Diode pulsed current, t_p limited by T_{vjmax}	I_{Fpulse}		300	A	
Power dissipation	P_{tot}		$T_c = 25\text{ }^\circ\text{C}$	460	W
			$T_c = 100\text{ }^\circ\text{C}$	230	

Table 5 Characteristic values

Parameter	Symbol	Note or test condition	Values			Unit	
			Min.	Typ.	Max.		
Diode forward voltage	V_F	$I_F = 100\text{ A}$	$T_{vj} = 25\text{ }^\circ\text{C}$		1.65	2.15	V
			$T_{vj} = 175\text{ }^\circ\text{C}$		1.6		
Diode reverse recovery time	t_{rr}	$V_R = 600\text{ V}, R_{G(on)} = 1.6\ \Omega$	$T_{vj} = 25\text{ }^\circ\text{C},$ $I_F = 100\text{ A}$		203		ns
			$T_{vj} = 175\text{ }^\circ\text{C},$ $I_F = 100\text{ A}$		351		
Diode reverse recovery charge	Q_{rr}	$V_R = 600\text{ V}, R_{G(on)} = 1.6\ \Omega$	$T_{vj} = 25\text{ }^\circ\text{C},$ $I_F = 100\text{ A}$		6.84		μC
			$T_{vj} = 175\text{ }^\circ\text{C},$ $I_F = 100\text{ A}$		15		

(table continues...)

Table 5 (continued) Characteristic values

Parameter	Symbol	Note or test condition	Values			Unit	
			Min.	Typ.	Max.		
Diode peak reverse recovery current	I_{rrm}	$V_R = 600 \text{ V}, R_{G(on)} = 1.6 \Omega$	$T_{vj} = 25 \text{ }^\circ\text{C}, I_F = 100 \text{ A}$		62		A
			$T_{vj} = 175 \text{ }^\circ\text{C}, I_F = 100 \text{ A}$		77		
Diode peak rate of fall of reverse recovery current	di_{rr}/dt	$V_R = 600 \text{ V}, R_{G(on)} = 1.6 \Omega$	$T_{vj} = 25 \text{ }^\circ\text{C}, I_F = 100 \text{ A}$		-350		A/ μs
			$T_{vj} = 175 \text{ }^\circ\text{C}, I_F = 100 \text{ A}$		-243		
Reverse recovery energy	E_{rec}	$V_R = 600 \text{ V}, R_{G(on)} = 1.6 \Omega$	$T_{vj} = 25 \text{ }^\circ\text{C}, I_F = 100 \text{ A}$		2.12		mJ
			$T_{vj} = 175 \text{ }^\circ\text{C}, I_F = 100 \text{ A}$		5.4		
Operating junction temperature	T_{vj}			-40		175	$^\circ\text{C}$

Note: For optimum lifetime and reliability, Infineon recommends operating conditions that do not exceed 80% of the maximum ratings stated in this datasheet.

Dynamic test circuit, parasitic inductance $L_\sigma = 30 \text{ nH}$, $C_\sigma = 18 \text{ pF}$.

4 Characteristics diagrams

Reverse bias safe operating area

$$I_C = f(V_{CE})$$

$$T_{vj} \leq 175\text{ °C}, V_{CE} \leq 1200\text{ V}$$

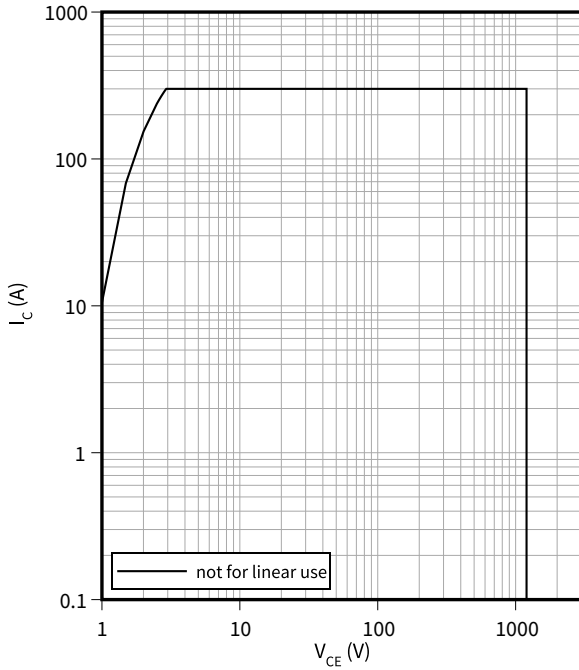

Typical output characteristic

$$I_C = f(V_{CE})$$

$$T_{vj} = 25\text{ °C}$$

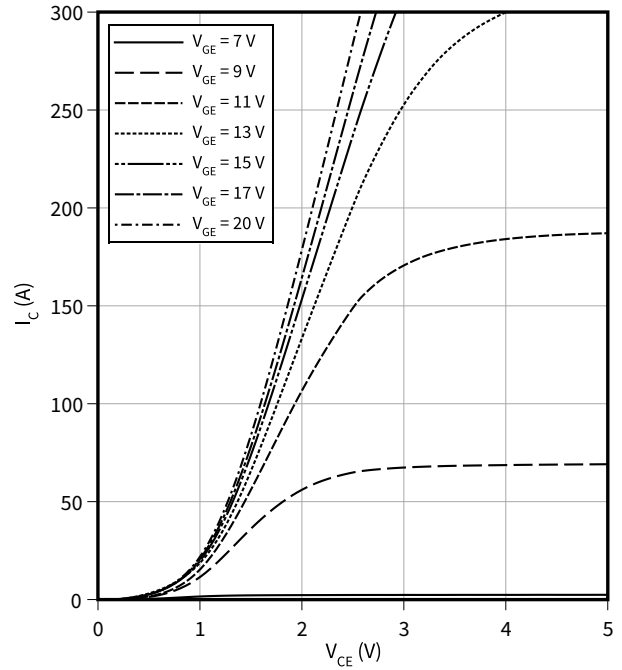

Typical output characteristic

$$I_C = f(V_{CE})$$

$$T_{vj} = 175\text{ °C}$$

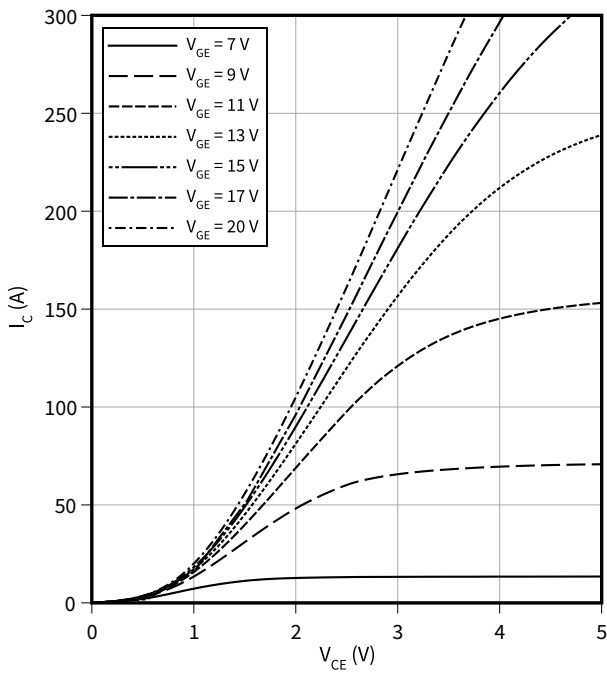

Typical transfer characteristic

$$I_C = f(V_{GE})$$

$$V_{CE} = 20\text{ V}$$

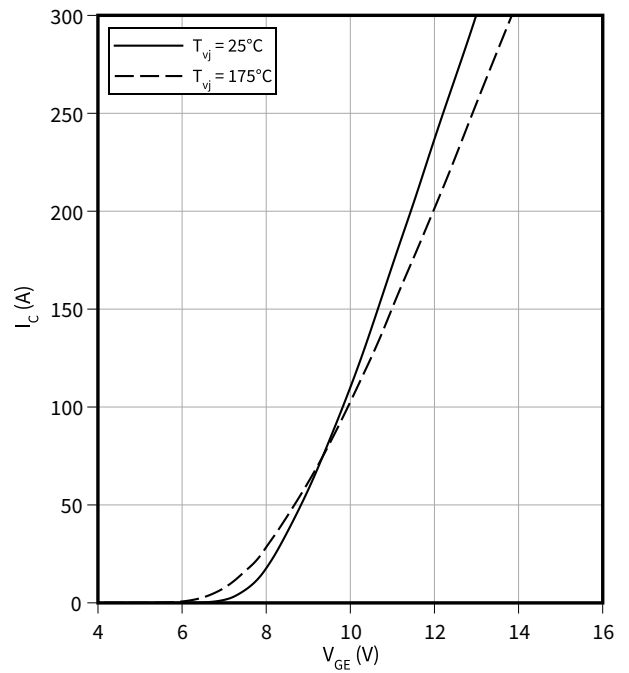

4 Characteristics diagrams

Typical collector-emitter saturation voltage as a function of junction temperature

$V_{CEsat} = f(T_{vj})$
 $V_{GE} = 15\text{ V}$

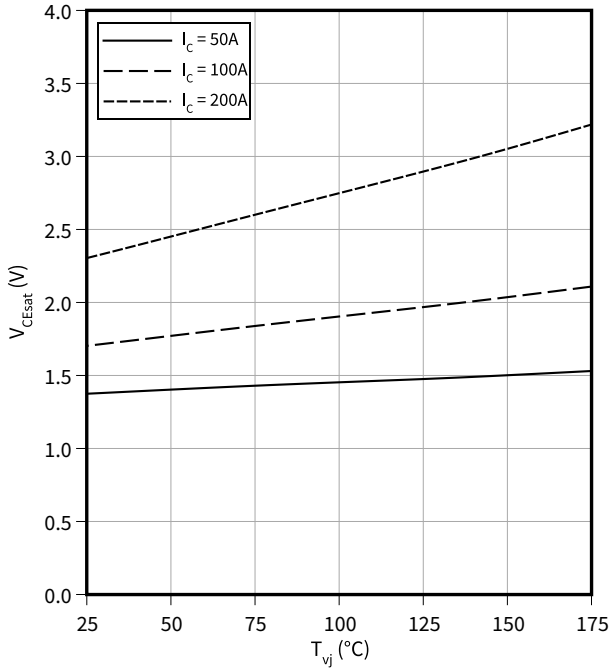

Gate-emitter threshold voltage as a function of junction temperature

$V_{GEth} = f(T_{vj})$
 $I_c = 2\text{ mA}$

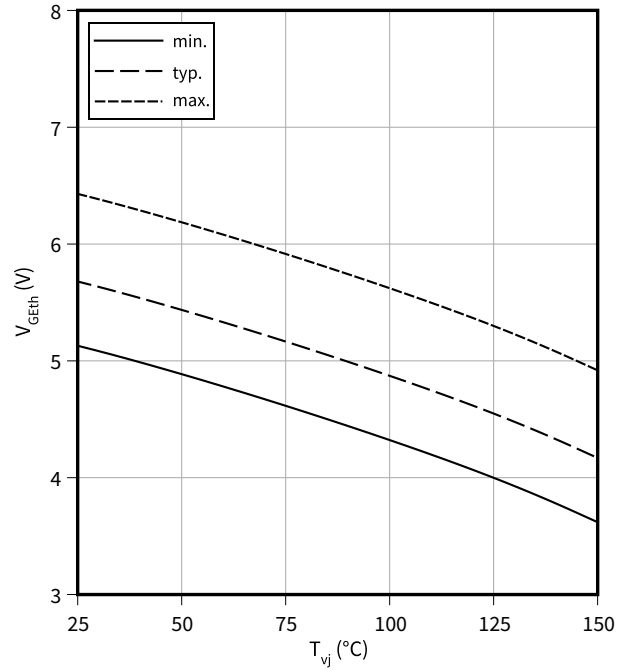

Typical switching times as a function of collector current

$t = f(I_c)$
 $V_{CC} = 600\text{ V}, T_{vj} = 175\text{ °C}, V_{GE} = 0/15\text{ V}, R_G = 1.6\text{ }\Omega$

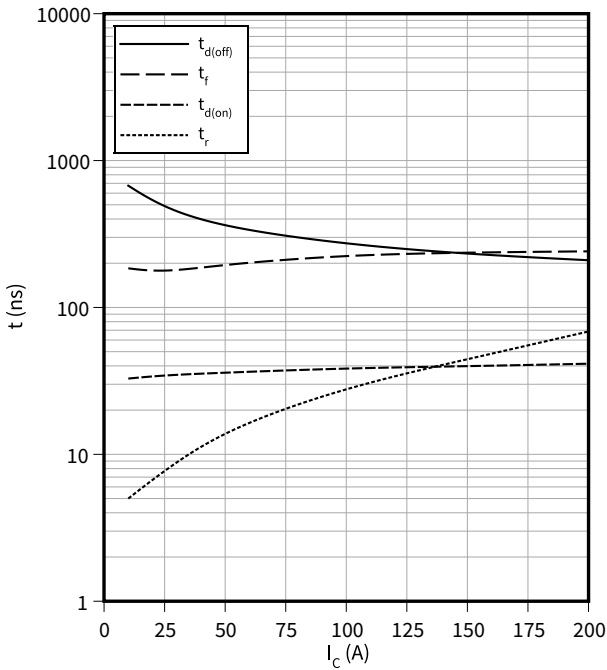

Typical switching times as a function of gate resistor

$t = f(R_G)$
 $I_c = 100\text{ A}, V_{CC} = 600\text{ V}, T_{vj} = 175\text{ °C}, V_{GE} = 0/15\text{ V}$

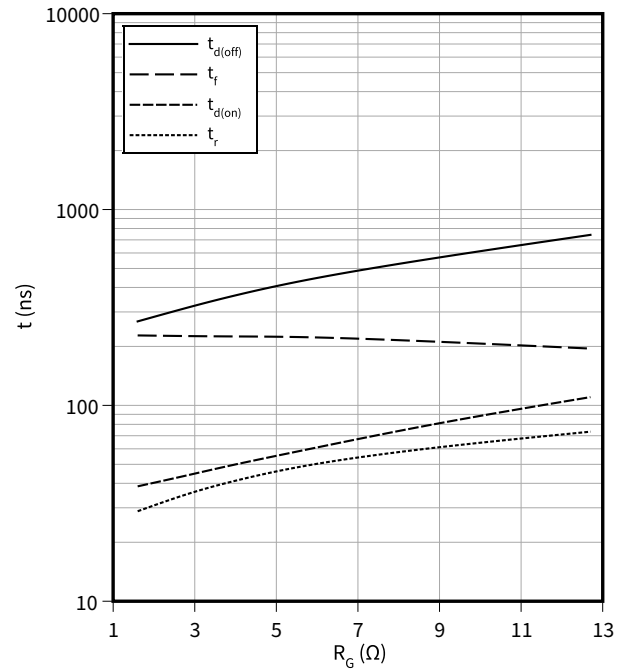

4 Characteristics diagrams

Typical switching times as a function of junction temperature

$t = f(T_{vj})$

$I_C = 100 \text{ A}, V_{CC} = 600 \text{ V}, V_{GE} = 0/15 \text{ V}, R_G = 1.6 \Omega$

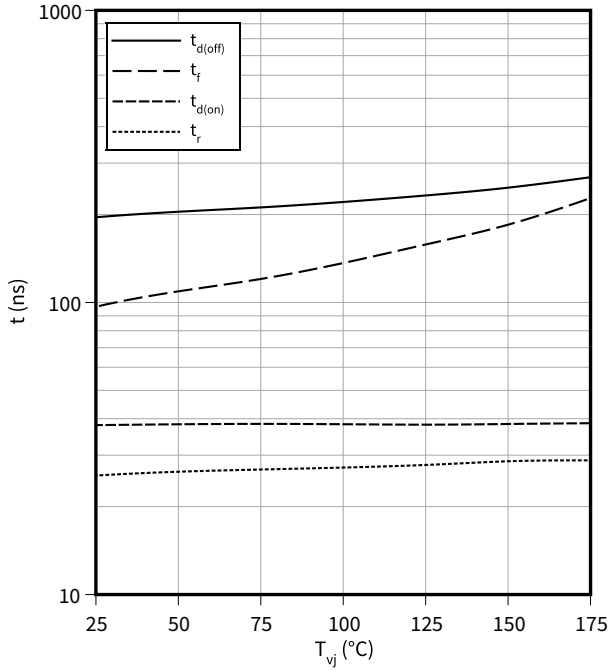

Typical switching energy losses as a function of collector current

$E = f(I_C)$

$V_{CC} = 600 \text{ V}, T_{vj} = 175 \text{ °C}, V_{GE} = 0/15 \text{ V}, R_G = 1.6 \Omega$

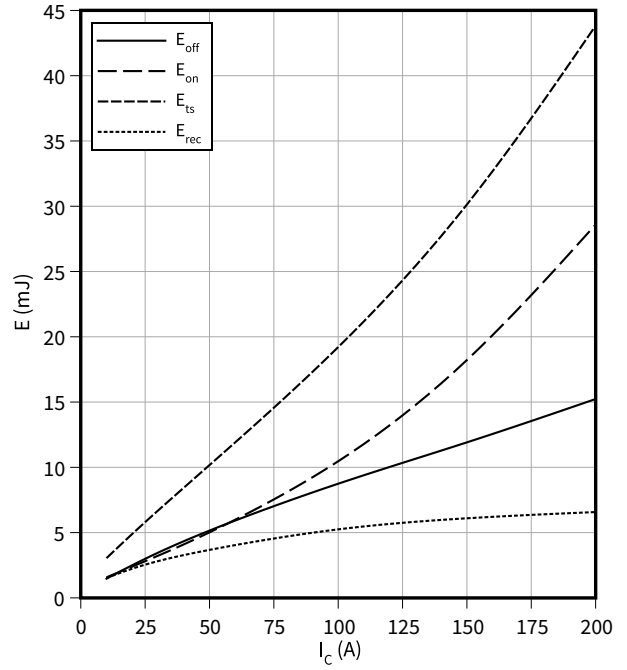

Typical switching energy losses as a function of gate resistor

$E = f(R_G)$

$I_C = 100 \text{ A}, V_{CC} = 600 \text{ V}, T_{vj} = 175 \text{ °C}, V_{GE} = 0/15 \text{ V}$

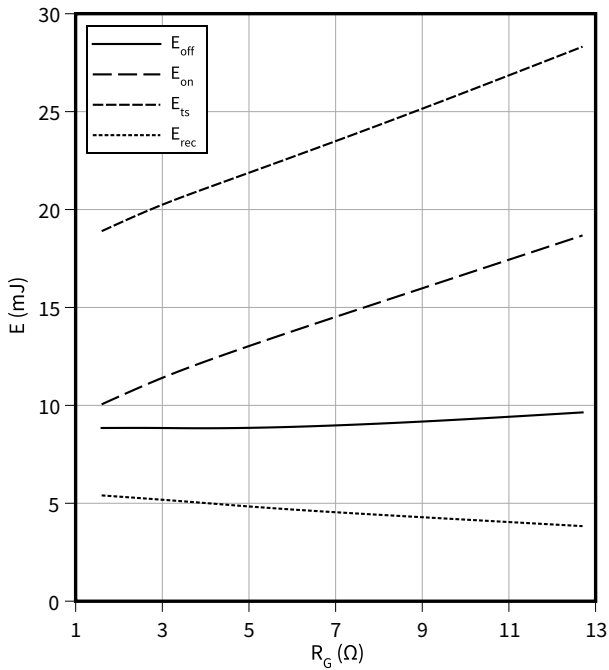

Typical switching energy losses as a function of junction temperature

$E = f(T_{vj})$

$I_C = 100 \text{ A}, V_{CC} = 600 \text{ V}, V_{GE} = 0/15 \text{ V}, R_G = 1.6 \Omega$

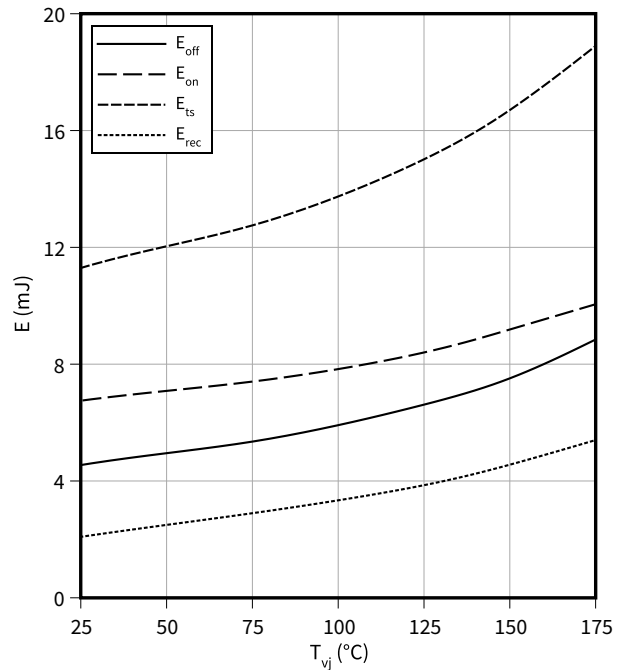

4 Characteristics diagrams

Typical switching energy losses as a function of collector emitter voltage

$E = f(V_{CE})$

$I_C = 100\text{ A}$, $T_{vj} = 175\text{ °C}$, $V_{GE} = 0/15\text{ V}$, $R_G = 1.6\ \Omega$

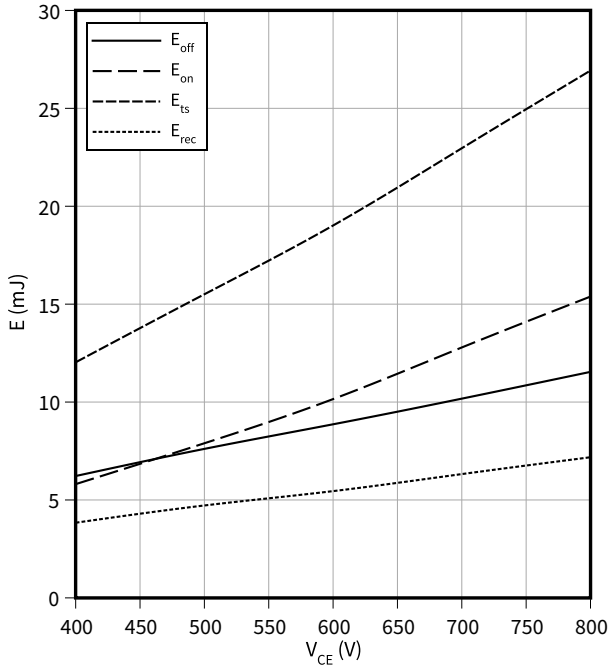

Typical gate charge

$V_{GE} = f(Q_G)$

$I_C = 100\text{ A}$

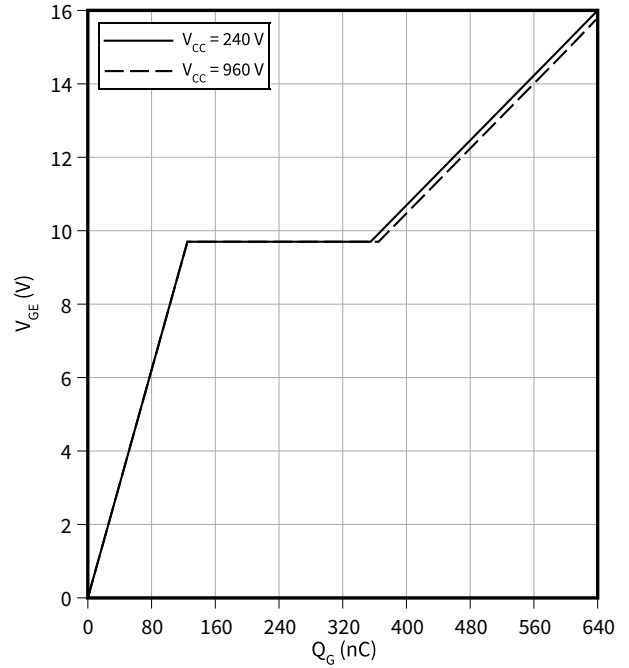

Typical capacitance as a function of collector-emitter voltage

$C = f(V_{CE})$

$f = 100\text{ kHz}$, $V_{GE} = 0\text{ V}$

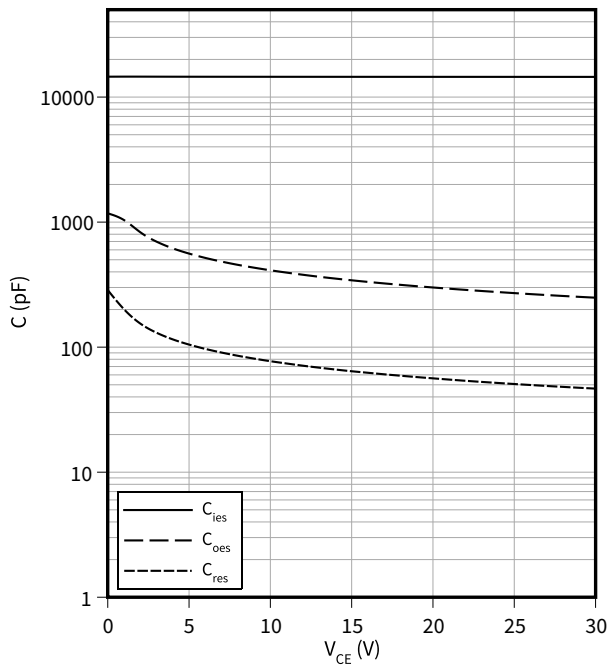

Typical short circuit collector current as a function of gate-emitter voltage

$I_{C(SC)} = f(V_{GE})$

$T_{vj} \leq 175\text{ °C}$, $V_{CC} \leq 600\text{ V}$

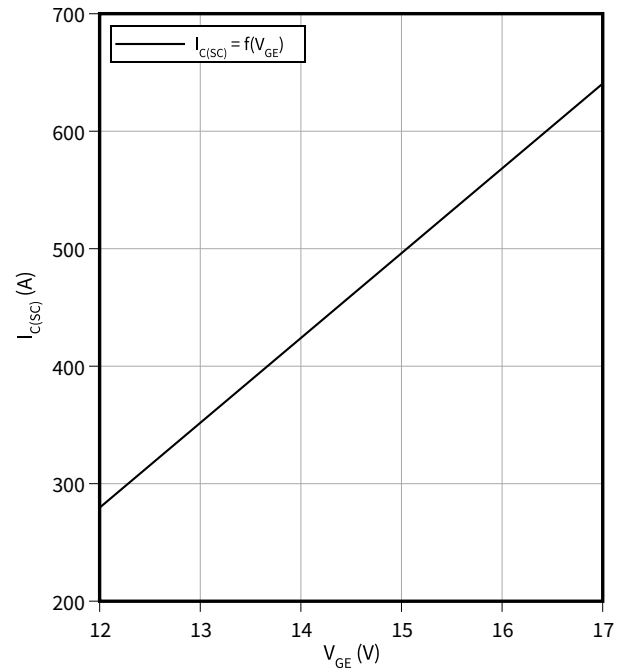

4 Characteristics diagrams

Short circuit withstand time as a function of gate-emitter voltage

$t_{SC} = f(V_{GE})$

$T_{vj} \leq 175^\circ\text{C}, V_{CC} \leq 600\text{ V}$

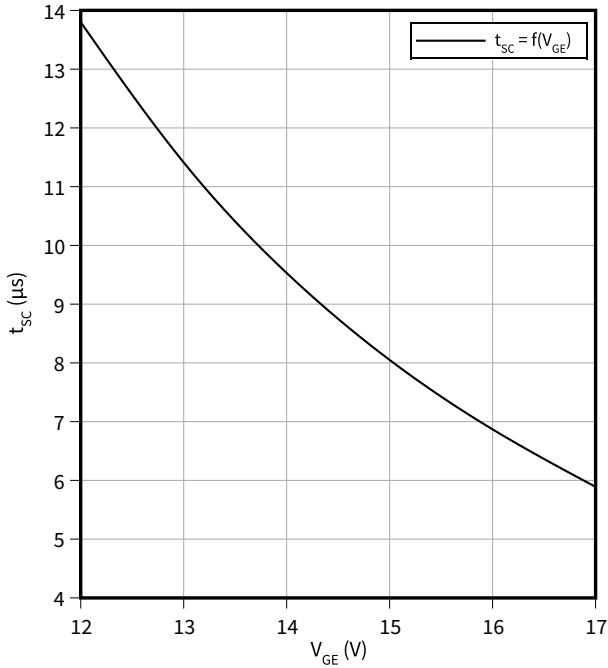

IGBT transient thermal impedance as a function of pulse width

$Z_{th(j-c)} = f(t_p)$

$D = t_p/T$

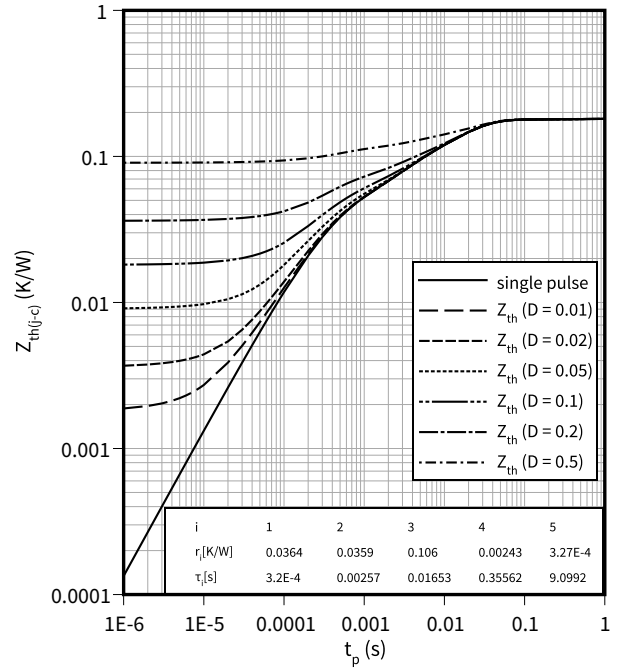

Diode transient thermal impedance as a function of pulse width

$Z_{th(j-c)} = f(t_p)$

$D = t_p/T$

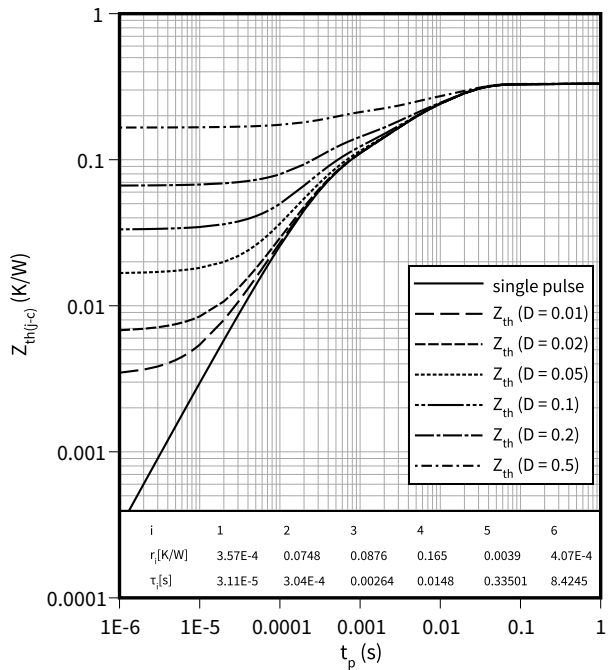

Typical diode forward current as a function of forward voltage

$I_F = f(V_F)$

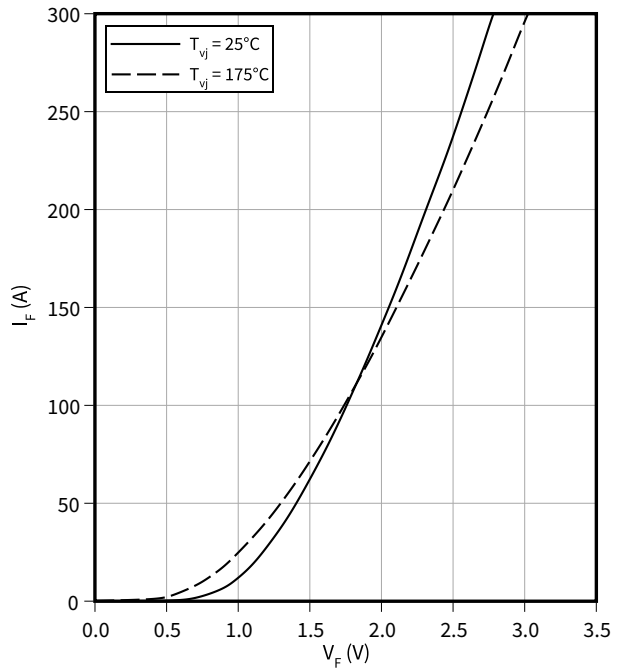

4 Characteristics diagrams

Typical diode forward voltage as a function of junction temperature

$V_F = f(T_{vj})$

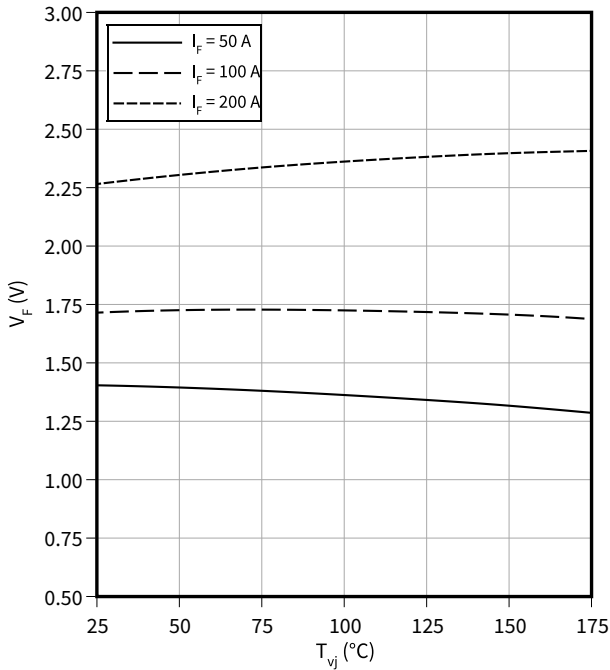

Typical diode current slope as a function of gate resistor

$di_F/dt = f(R_G)$

$V_R = 600$ V, $I_F = 100$ A

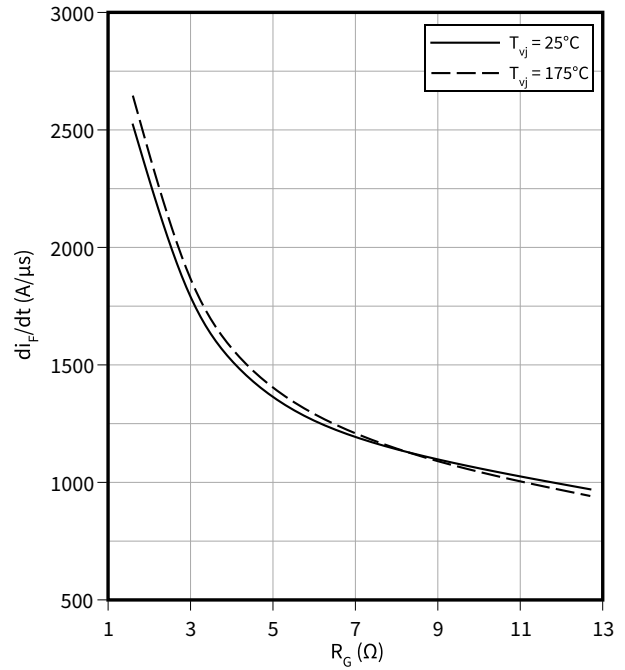

Typical reverse recovery time as a function of diode current slope

$t_{rr} = f(di_F/dt)$

$V_R = 600$ V, $I_F = 100$ A

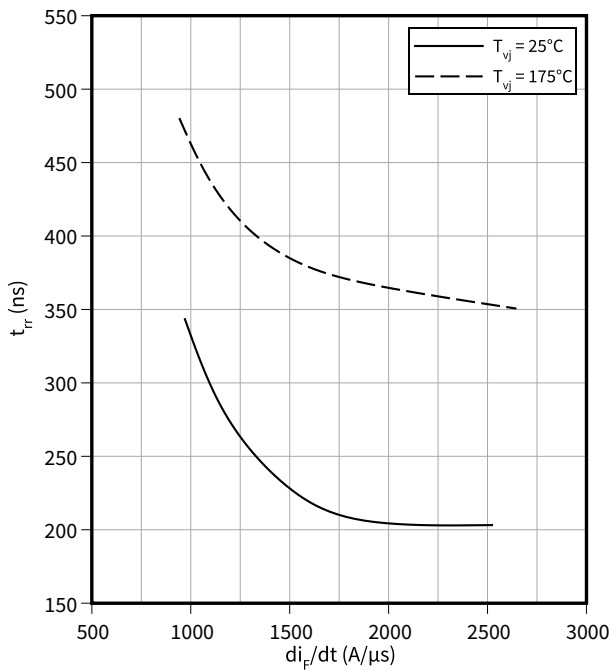

Typical reverse recovery charge as a function of diode current slope

$Q_{rr} = f(di_F/dt)$

$V_R = 600$ V, $I_F = 100$ A

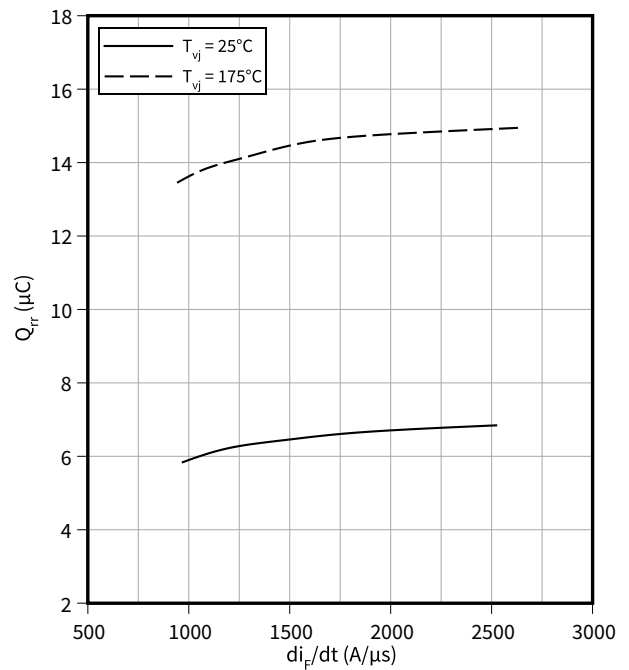

4 Characteristics diagrams

Typical reverse recovery current as a function of diode current slope

$I_{rrm} = f(di_F/dt)$

$V_R = 600\text{ V}, I_F = 100\text{ A}$

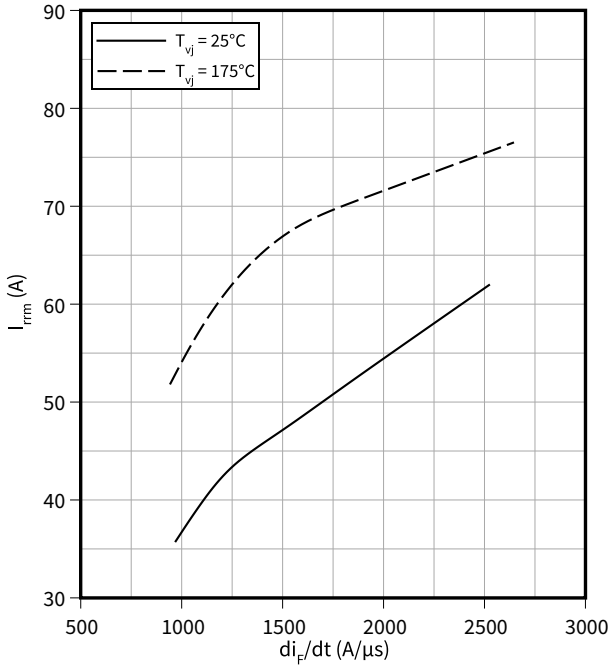

Typical diode peak rate of fall of reverse recovery current as a function of diode current slope

$di_{rr}/dt = f(di_F/dt)$

$V_R = 600\text{ V}, I_F = 100\text{ A}$

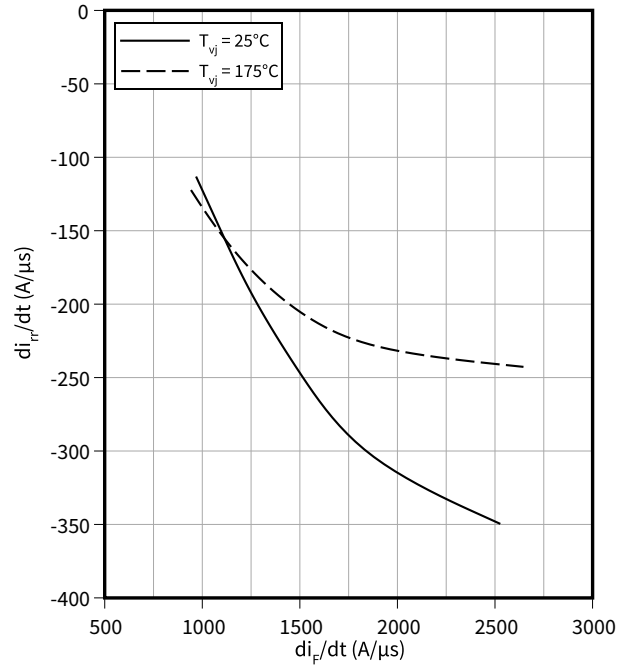

Typical reverse energy losses as a function of diode current slope

$E_{rec} = f(di_F/dt)$

$V_R = 600\text{ V}, I_F = 100\text{ A}$

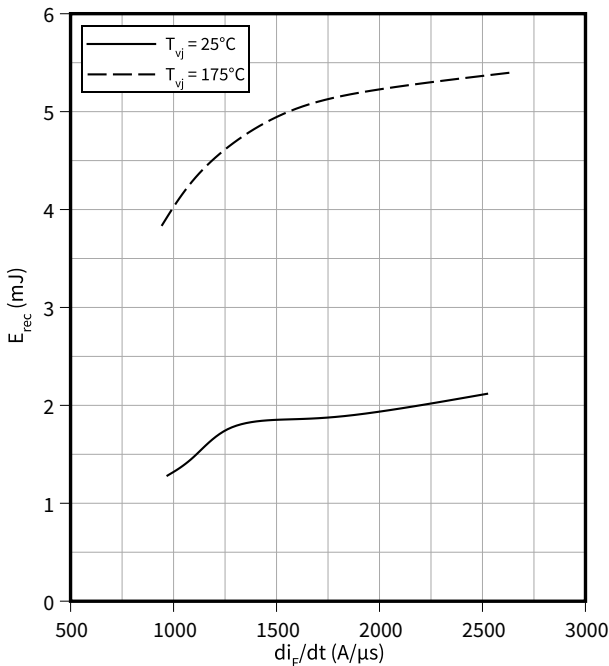

5 Package outlines

PG-TO247-3-PLUS-NN3.7

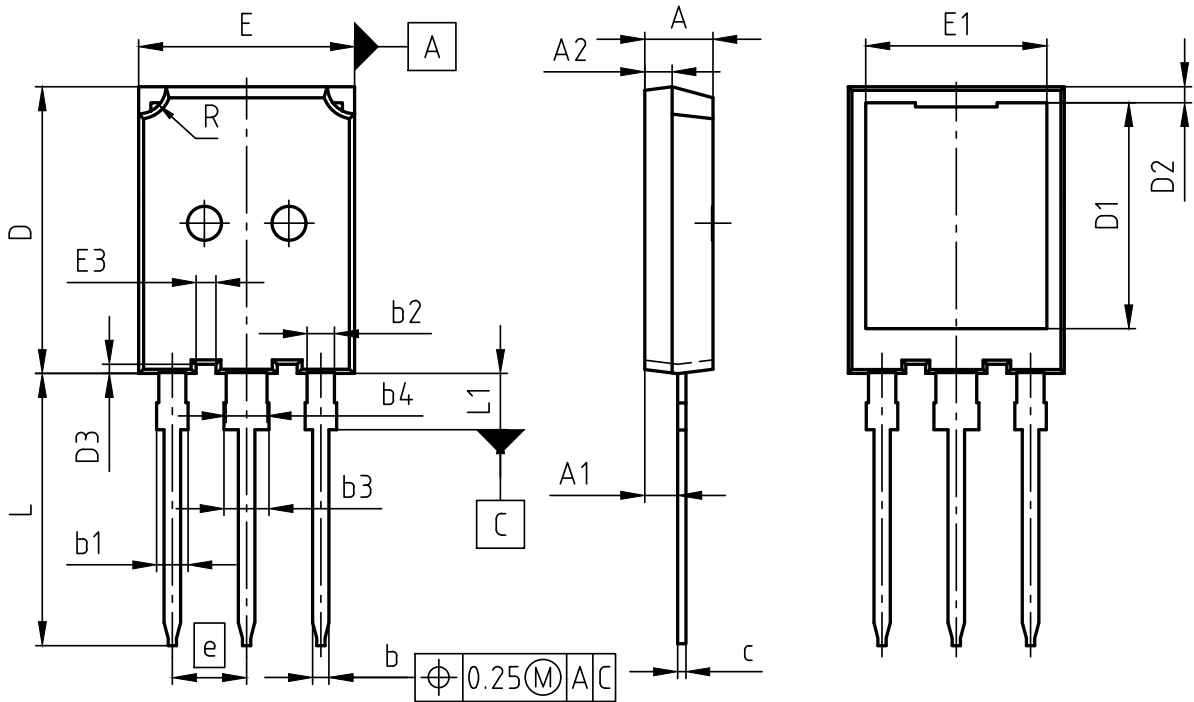

PACKAGE - GROUP NUMBER:		PG-TO247-3-U01	
DIMENSIONS	MILLIMETERS		
	MIN.	MAX.	
A	4.90	5.10	
A1	2.31	2.51	
A2	1.90	2.10	
b	1.16	1.26	
b1	1.96	2.06	
b2	2.77	3.38	
b3	2.96	3.25	
b4	2.96	3.06	
c	0.59	0.66	
D	20.90	21.10	
D1	16.25	16.85	
D2	1.05	1.35	
D3	0.58	0.78	
E	15.70	16.90	
E1	13.10	13.50	
E3	1.35	1.55	
e	5.44 (BSC)		
N	3		
L	19.80	20.10	
L1	3.90	4.30	
R	1.90	2.10	

NOTE:
 DIMENSIONS DO NOT INCLUDE MOLDFLASH; PROTRUSION OR GATE BURRS

Figure 1

6 Testing conditions



Figure 2

Revision history

Document revision	Date of release	Description of changes
0.10	2022-05-04	Target datasheet
1.00	2022-12-05	Final datasheet

Trademarks

All referenced product or service names and trademarks are the property of their respective owners.

Edition 2022-12-05

Published by

Infineon Technologies AG

81726 Munich, Germany

© 2022 Infineon Technologies AG

All Rights Reserved.

Do you have a question about any aspect of this document?

Email: erratum@infineon.com

Document reference

IFX-ABB787-002

Important notice

The information given in this document shall in no event be regarded as a guarantee of conditions or characteristics ("Beschaffheitsgarantie").

With respect to any examples, hints or any typical values stated herein and/or any information regarding the application of the product, Infineon Technologies hereby disclaims any and all warranties and liabilities of any kind, including without limitation warranties of non-infringement of intellectual property rights of any third party.

In addition, any information given in this document is subject to customer's compliance with its obligations stated in this document and any applicable legal requirements, norms and standards concerning customer's products and any use of the product of Infineon Technologies in customer's applications.

The data contained in this document is exclusively intended for technically trained staff. It is the responsibility of customer's technical departments to evaluate the suitability of the product for the intended application and the completeness of the product information given in this document with respect to such application.

Please note that this product is not qualified according to the AEC Q100 or AEC Q101 documents of the Automotive Electronics Council.

Warnings

Due to technical requirements products may contain dangerous substances. For information on the types in question please contact your nearest Infineon Technologies office.

Except as otherwise explicitly approved by Infineon Technologies in a written document signed by authorized representatives of Infineon Technologies, Infineon Technologies' products may not be used in any applications where a failure of the product or any consequences of the use thereof can reasonably be expected to result in personal injury.

单击下面可查看定价，库存，交付和生命周期等信息

[>>Infineon\(英飞凌\)](#)