

# IRG4PC50SDPbF

INSULATED GATE BIPOLAR TRANSISTOR WITH  
ULTRAFAST SOFT RECOVERY DIODE

Standard Speed CoPack IGBT

## Features

- Standard: Optimized for minimum saturation voltage and low operating frequencies (<1kHz)
- IGBT co-packaged with HEXFRED™ ultrafast, ultra-soft-recovery anti-parallel diodes for use in bridge configurations
- Industry standard TO-247AC package

## Benefits

- Generation -4 IGBT's offer highest efficiencies available
- IGBT's optimized for specific application conditions
- HEXFRED diodes optimized for performance with IGBT's. Minimized recovery characteristics require less/no snubbing

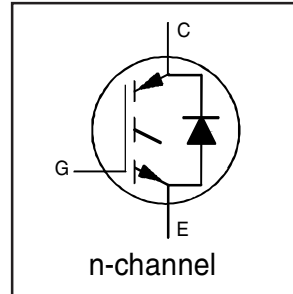

$V_{CES} = 600V$
$V_{CE(on) typ.} = 1.28V$
@ $V_{GE} = 15V, I_C = 41A$

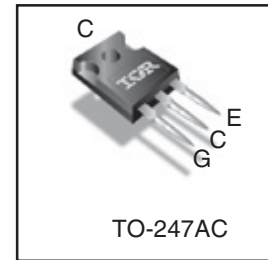

<b>G</b>	<b>C</b>	<b>E</b>
Gate	Collector	Emitter

## Absolute Maximum Ratings

	Parameter	Max.	Units
$V_{CES}$	Collector-to-Emitter Breakdown Voltage	600	V
$I_C @ T_C = 25^\circ C$	Continuous Collector Current	70	A
$I_C @ T_C = 100^\circ C$	Continuous Collector Current	41	
$I_{CM}$	Pulsed Collector Current ①	140	
$I_{LM}$	Clamped Inductive Load Current ②	140	
$I_F @ T_C = 100^\circ C$	Diode Continuous Forward Current	25	
$I_{FM}$	Diode Maximum Forward Current ③	280	
$V_{GE}$	Continuous Gate-to-Emitter Voltage	$\pm 20$	V
$P_D @ T_C = 25^\circ C$	Maximum Power Dissipation	200	W
$P_D @ T_C = 100^\circ C$	Maximum Power Dissipation	78	
$T_J$	Operating Junction and Storage Temperature Range	-55 to +150	°C
$T_{STG}$			
	Soldering Temperature, for 10 sec.	300 (0.063 in. (1.6mm) from case)	
	Mounting Torque, 6-32 or M3 Screw	10 lbf-in (1.1 N-m)	

## Thermal Resistance

	Parameter	Min.	Typ.	Max.	Units
$R_{\theta JC}$ (IGBT)	Thermal Resistance Junction-to-Case-(each IGBT)	—	—	0.64	°C/W
$R_{\theta JC}$ (Diode)	Thermal Resistance Junction-to-Case-(each Diode)	—	—	0.83	
$R_{\theta CS}$	Thermal Resistance, Case-to-Sink (flat, greased surface)	—	0.24	—	
$R_{\theta JA}$	Thermal Resistance, Junction-to-Ambient (typical socket mount)	—	—	40	

## Electrical Characteristics @ $T_J = 25^\circ\text{C}$ (unless otherwise specified)

	Parameter	Min.	Typ.	Max.	Units	Conditions	Ref.Fig
$V_{(BR)CES}$	Collector-to-Emitter Breakdown Voltage	600	—	—	V	$V_{GE} = 0V, I_C = 250\mu A$	
$\Delta V_{(BR)CES}/\Delta T_J$	Temperature Coeff. of Breakdown Voltage	—	0.75	—	V/ $^\circ\text{C}$	$V_{GE} = 0V, I_C = 1mA (25^\circ\text{C}-150^\circ\text{C})$	
$V_{CE(on)}$	Collector-to-Emitter Saturation Voltage	—	1.28	1.36	V	$I_C = 41A, V_{GE} = 15V, T_J = 25^\circ\text{C}$	2
		—	1.62	—		$I_C = 80A, V_{GE} = 15V, T_J = 25^\circ\text{C}$	
		—	1.25	—		$I_C = 41A, V_{GE} = 15V, T_J = 150^\circ\text{C}$	
$V_{GE(th)}$	Gate Threshold Voltage	3.0	—	6.0	V	$V_{CE} = V_{GE}, I_C = 250\mu A$	3
$\Delta V_{GE(th)}/\Delta T_J$	Threshold Voltage temp. coefficient	—	-9.3	—	mV/ $^\circ\text{C}$	$V_{CE} = V_{GE}, I_C = 250\mu A (25^\circ\text{C} - 150^\circ\text{C})$	
$g_{fe}$	Forward Transconductance	17	34	—	S	$V_{CE} = 100V, I_C = 41A$	
$I_{CES}$	Collector-to-Emitter Leakage Current	—	—	250	$\mu A$	$V_{GE} = 0V, V_{CE} = 600V$	
		—	—	2.0		$V_{GE} = 0V, V_{CE} = 10V, T_J = 25^\circ\text{C}$	
		—	—	1000		$V_{GE} = 0V, V_{CE} = 600V, T_J = 150^\circ\text{C}$	
$V_{FM}$	Diode Forward Voltage Drop	—	1.3	1.7	V	$I_F = 25A$	13
		—	1.2	1.5		$I_F = 25A, T_J = 150^\circ\text{C}$	
$I_{GES}$	Gate-to-Emitter Leakage Current	—	—	$\pm 100$	nA	$V_{GE} = \pm 20V$	

## Switching Characteristics @ $T_J = 25^\circ\text{C}$ (unless otherwise specified)

	Parameter	Min.	Typ.	Max.	Units	Conditions	Ref.Fig
$Q_g$	Total Gate Charge (turn-on)	—	180	280	nC	$I_C = 41A$ $V_{GE} = 15V$ $V_{CC} = 400V$	8
$Q_{ge}$	Gate-to-Emitter Charge (turn-on)	—	24	37			
$Q_{gc}$	Gate-to-Collector Charge (turn-on)	—	61	92			
$E_{on}$	Turn-On Switching Loss	—	0.72	—	mJ	$I_C = 41A, V_{CC} = 480V, V_{GE} = 15V$ $R_G = 5.0\Omega, T_J = 25^\circ\text{C}$ Energy losses include tail & diode reverse recovery	18a, 18b
$E_{off}$	Turn-Off Switching Loss	—	8.27	—			18c
$E_{total}$	Total Switching Loss	—	8.99	13			
$t_{d(on)}$	Turn-On delay time	—	33	—	ns	$I_C = 41A, V_{CC} = 480V, V_{GE} = 15V$ $R_G = 5.0\Omega, L = 200\mu H, T_J = 25^\circ\text{C}$	18a, 18b
$t_r$	Rise time	—	30	—			18c
$t_{d(off)}$	Turn-Off delay time	—	650	980			
$t_f$	Fall time	—	400	600			
$E_{total}$	Total Switching Loss	—	15	—	mJ	$I_C = 41A, V_{CC} = 480V, V_{GE} = 15V$ $R_G = 5.0\Omega, L = 200\mu H$ $T_J = 150^\circ\text{C}$	18a, 18b
$t_{d(on)}$	Turn-On delay time	—	31	—			18c
$t_r$	Rise time	—	31	—			
$t_{d(off)}$	Turn-Off delay time	—	1080	—			
$t_f$	Fall time	—	620	—			
$C_{ies}$	Input Capacitance	—	4100	—	pF	$V_{GE} = 0V$ $V_{CC} = 30V$ $f = 1.0Mhz$	7
$C_{oes}$	Output Capacitance	—	250	—			
$C_{res}$	Reverse Transfer Capacitance	—	48	—			
$t_{rr}$	Diode Reverse Recovery Time	—	50	75	ns	$T_J = 25^\circ\text{C}, V_R = 200V, I_F = 25A, di/dt=200A/\mu s$	14
		—	105	160		$T_J = 125^\circ\text{C}, V_R = 200V, I_F = 25A, di/dt=200A/\mu s$	18a, 18d
$I_{rr}$	Peak Reverse Recovery Current	—	4.5	10	A	$T_J = 25^\circ\text{C}, V_R = 200V, I_F = 25A, di/dt=200A/\mu s$	15
		—	8.0	15		$T_J = 125^\circ\text{C}, V_R = 200V, I_F = 25A, di/dt=200A/\mu s$	18a, 18d
$Q_{rr}$	Peak Reverse Recovery Current	—	112	375	nC	$T_J = 25^\circ\text{C}, V_R = 200V, I_F = 25A, di/dt=200A/\mu s$	16
		—	420	1200		$T_J = 125^\circ\text{C}, V_R = 200V, I_F = 25A, di/dt=200A/\mu s$	18a, 18d
$di_{(rec)M}/dt$	Peak Rate of Fall of Recovery During $t_b$	—	250	—	A/ $\mu s$	$T_J = 25^\circ\text{C}, V_R = 200V, I_F = 25A, di/dt=200A/\mu s$	17
		—	160	—		$T_J = 125^\circ\text{C}, V_R = 200V, I_F = 25A, di/dt=200A/\mu s$	

Notes:

- ① Repetitive rating:  $V_{GE}=15V$ ; pulse width limited by maximum junction temperature. (See figure 20)
- ②  $V_{CC}=80\%(V_{CES}), V_{GE}=15V, R_G = 5.0\Omega$ . (See figure 19)
- ③ Pulse width  $\leq 80\mu s$ ; duty factor  $\leq 0.1\%$ .

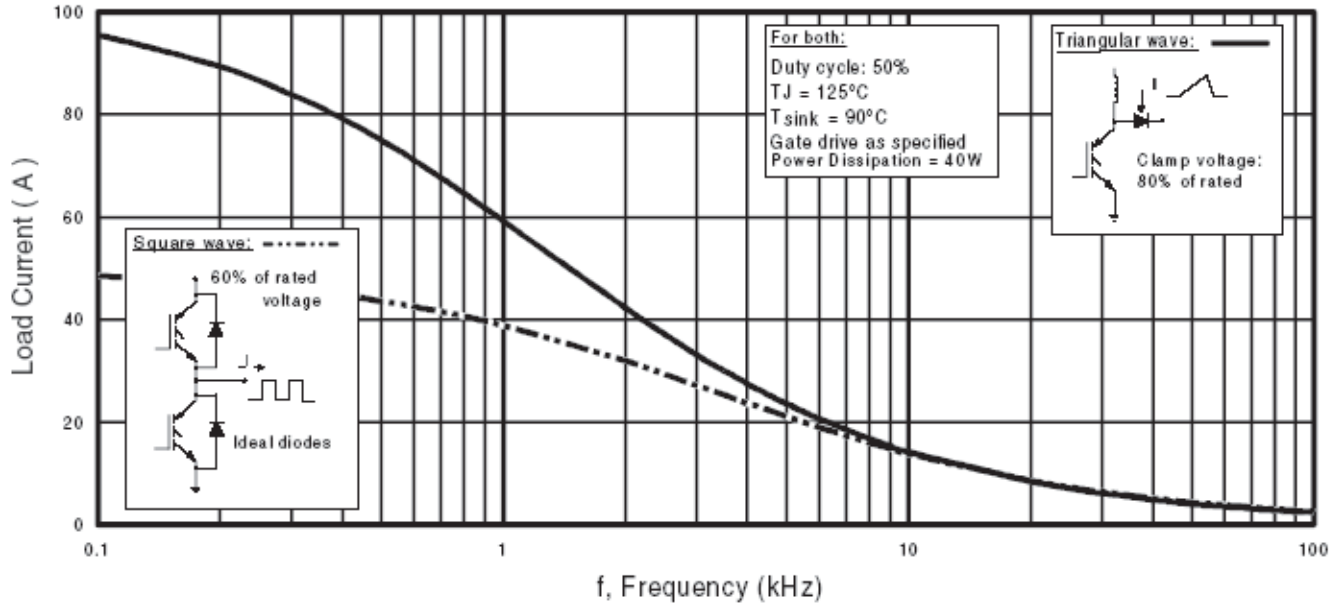

Fig. 1 - Typical Load Current vs. Frequency  
(Load Current =  $I_{\text{RMS}}$  of fundamental)

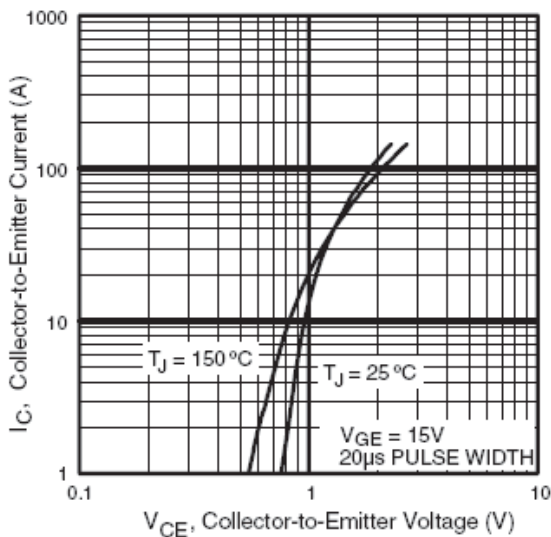

Fig. 2 - Typical Output Characteristics

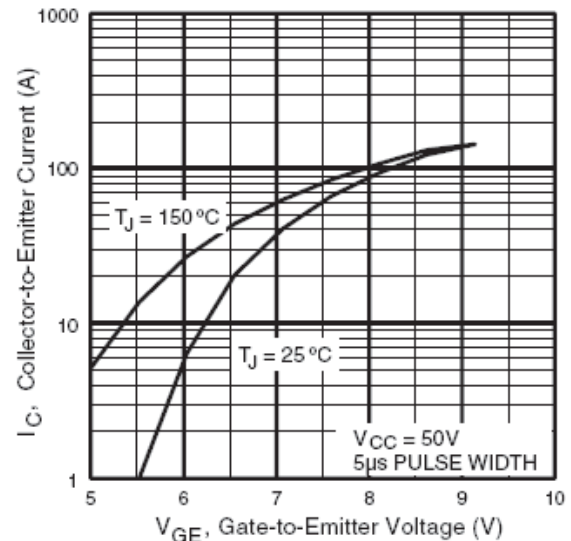
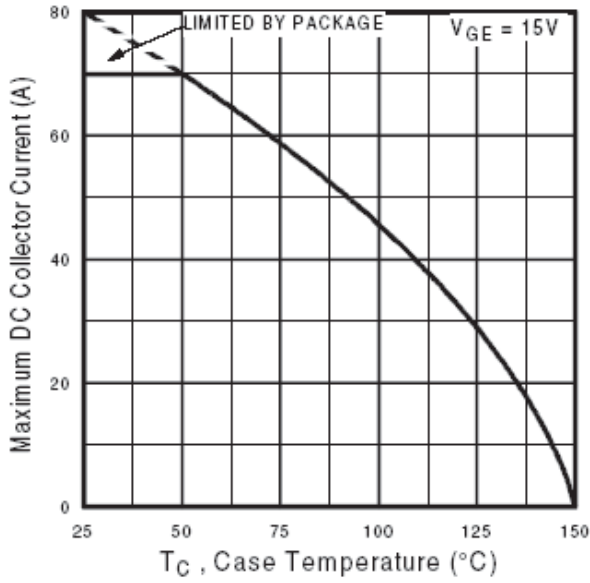
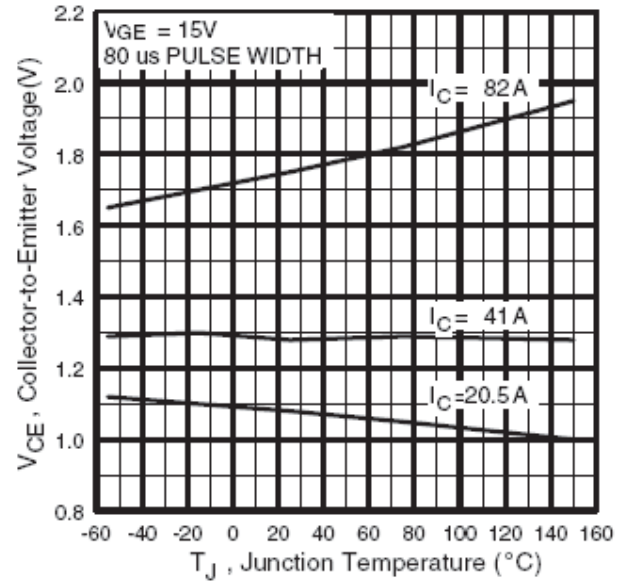

Fig. 3 - Typical Transfer Characteristics



**Fig. 4** - Maximum Collector Current vs. Case Temperature



**Fig. 5** - Typical Collector-to-Emitter Voltage vs. Junction Temperature

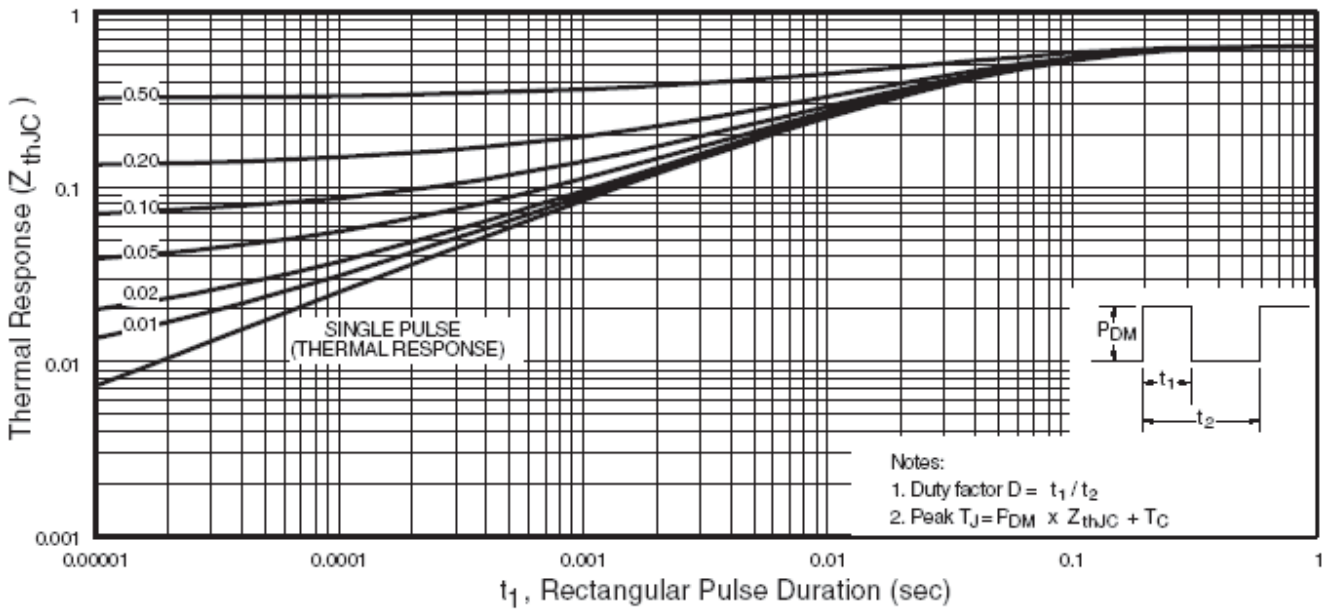

**Fig. 6** - Maximum IGBT Effective Transient Thermal Impedance, Junction-to-Case

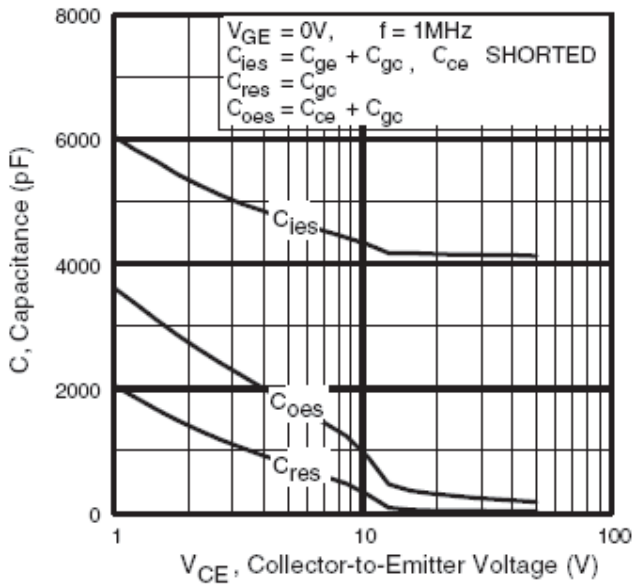

**Fig. 7 - Typical Capacitance vs. Collector-to-Emitter Voltage**

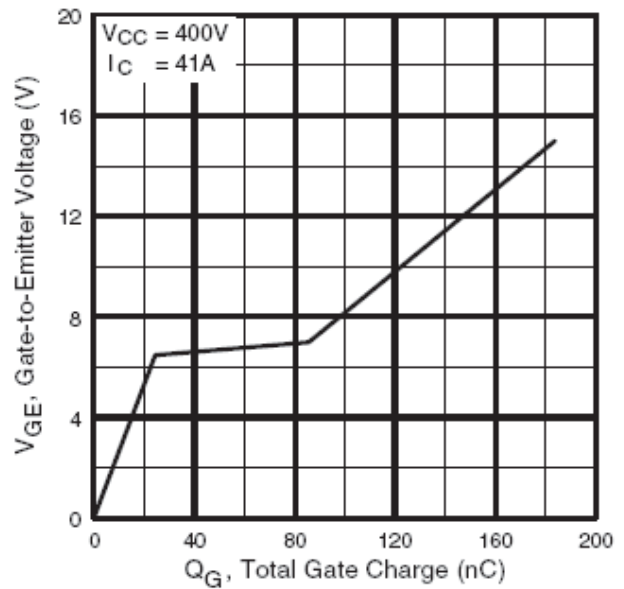

**Fig. 8 - Typical Gate Charge vs. Gate-to-Emitter Voltage**

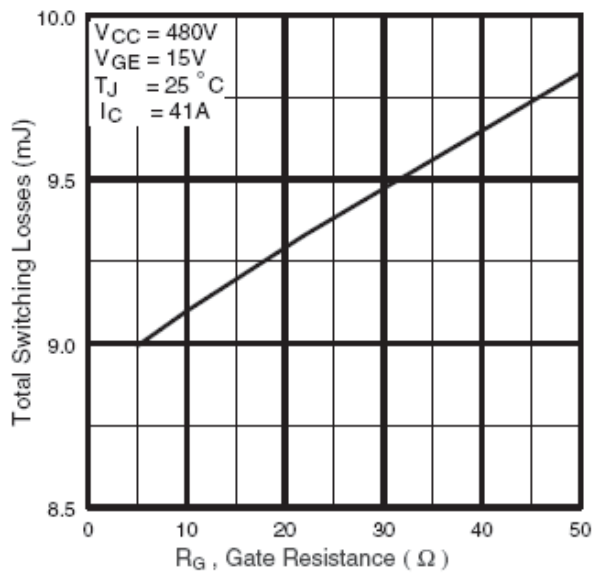

**Fig. 9 - Typical Switching Losses vs. Gate Resistance**

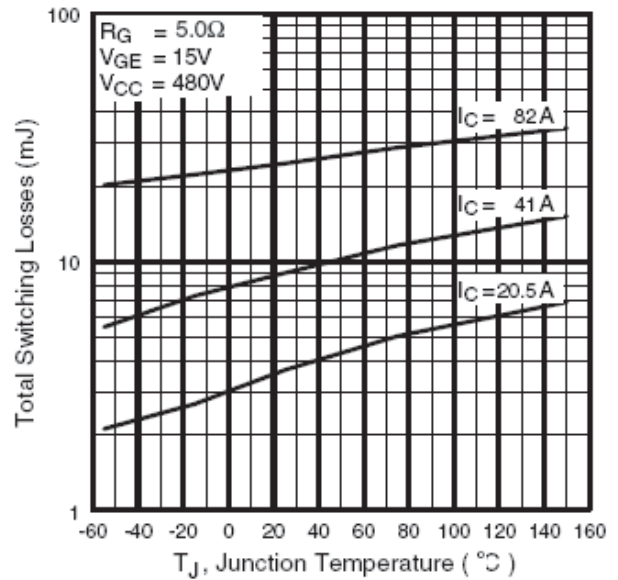

**Fig. 10 - Typical Switching Losses vs. Junction Temperature**

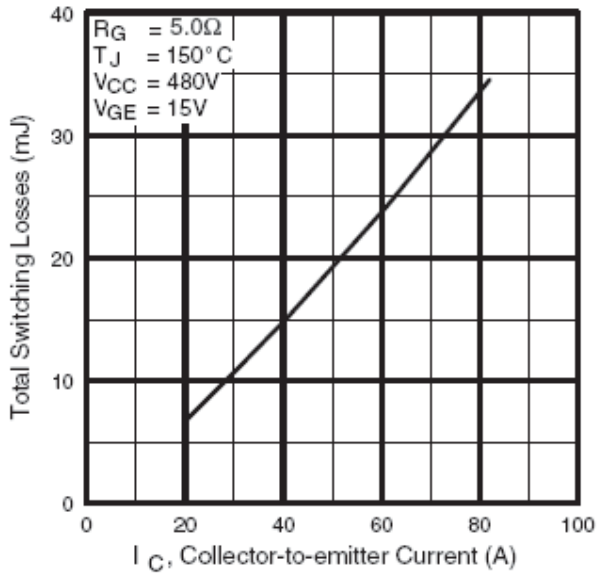

**Fig. 11** - Typical Switching Losses vs. Collector-to-Emitter Current

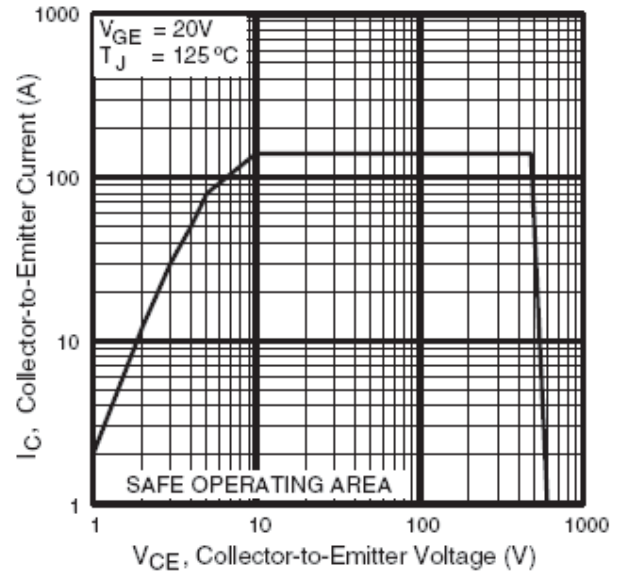

**Fig. 12** - Turn-Off SOA

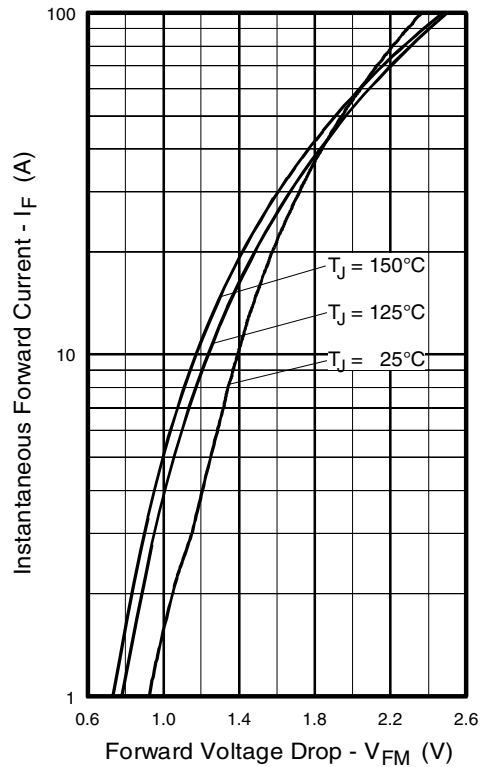

**Fig. 13** - Maximum Forward Voltage Drop vs. Instantaneous Forward Current

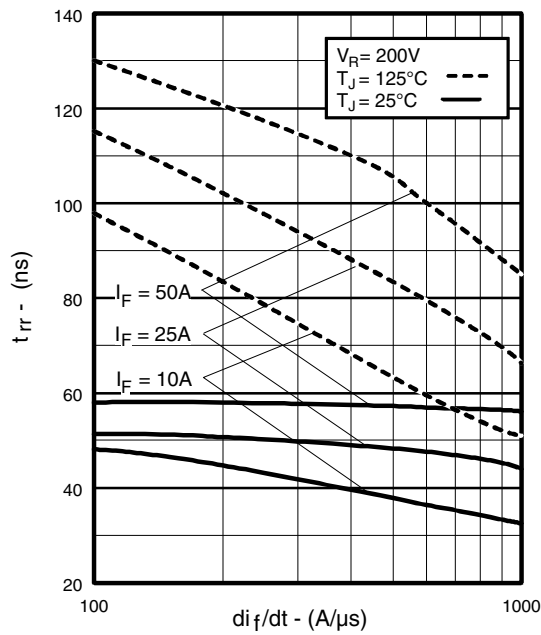

Fig. 14 - Typical Reverse Recovery vs.  $di_f/dt$

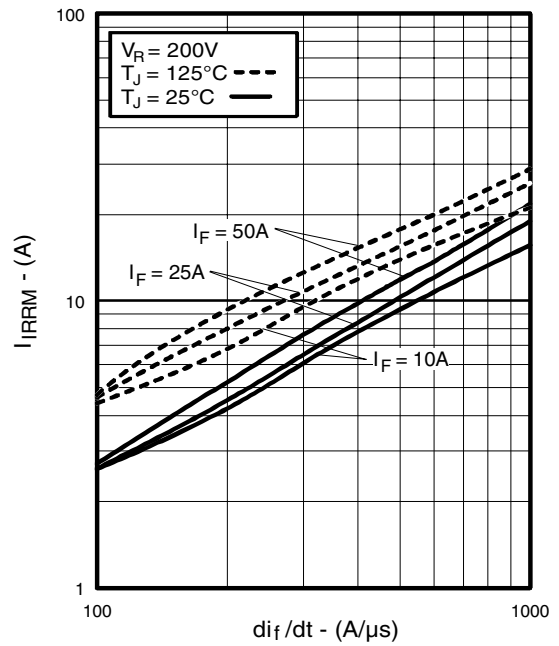

Fig. 15 - Typical Recovery Current vs.  $di_f/dt$

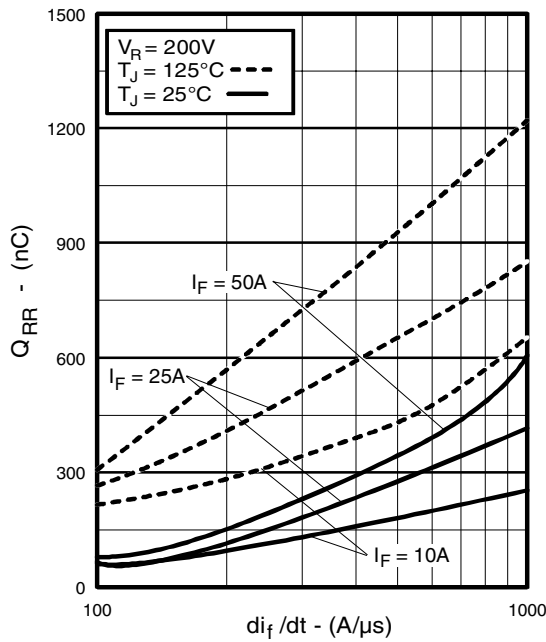

Fig. 16 - Typical Stored Charge vs.  $di_f/dt$

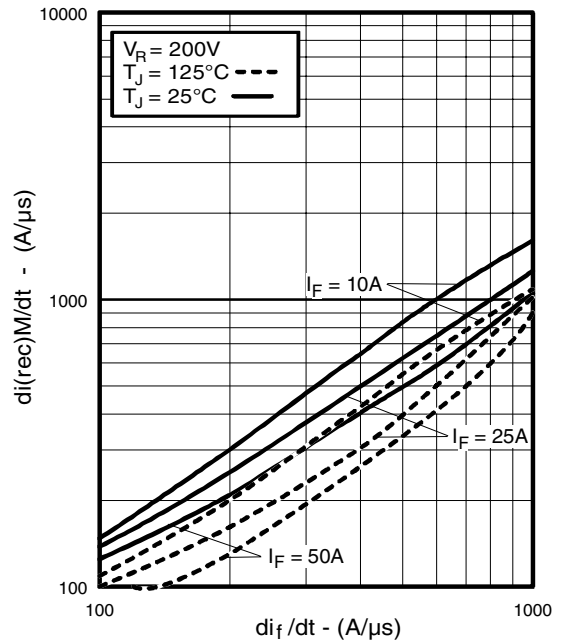
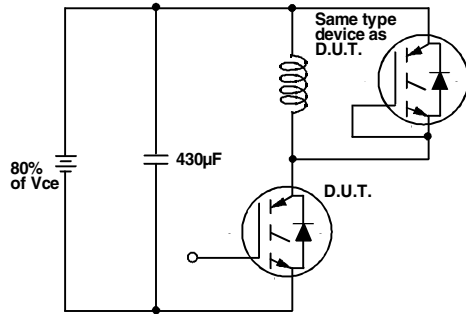
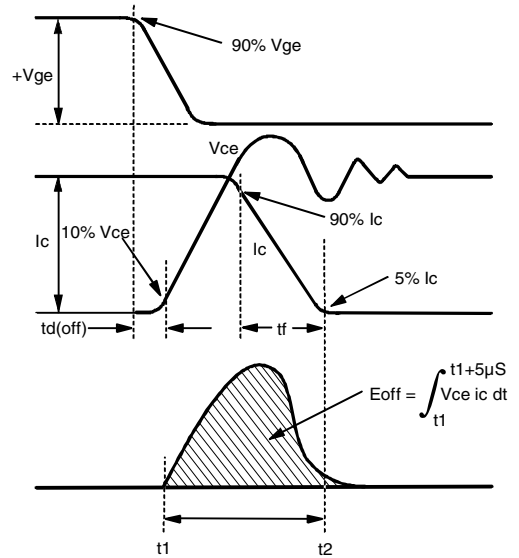

Fig. 17 - Typical  $di_{(rec)M}/dt$  vs.  $di_f/dt$



**Fig. 18a** - Test Circuit for Measurement of  $I_{LM}$ ,  $E_{on}$ ,  $E_{off}(\text{diode})$ ,  $t_{rr}$ ,  $Q_{rr}$ ,  $I_{rr}$ ,  $t_{d(on)}$ ,  $t_r$ ,  $t_{d(off)}$ ,  $t_f$



**Fig. 18b** - Test Waveforms for Circuit of Fig. 18a, Defining  $E_{off}$ ,  $t_{d(off)}$ ,  $t_f$

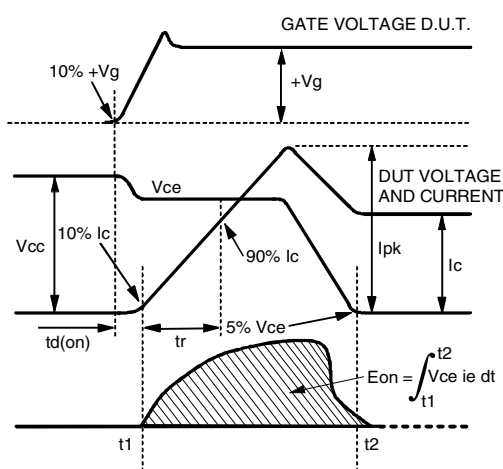

**Fig. 18c** - Test Waveforms for Circuit of Fig. 18a, Defining  $E_{on}$ ,  $t_{d(on)}$ ,  $t_r$

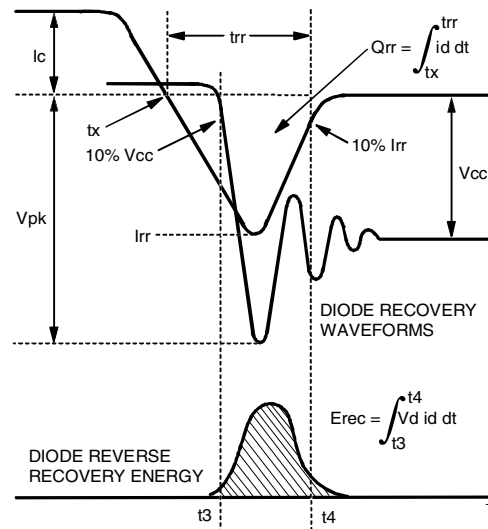

**Fig. 18d** - Test Waveforms for Circuit of Fig. 18a, Defining  $E_{rec}$ ,  $t_{rr}$ ,  $Q_{rr}$ ,  $I_{rr}$



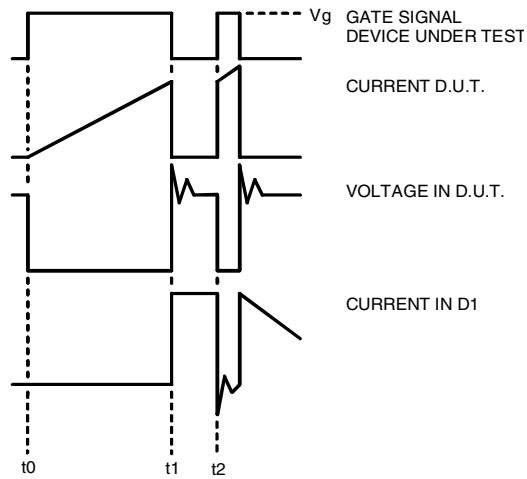

Figure 18e. Macro Waveforms for Figure 18a's Test Circuit

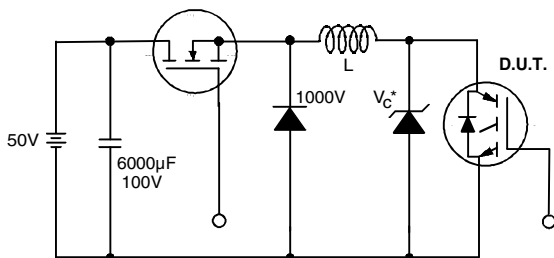

Figure 19. Clamped Inductive Load Test Circuit

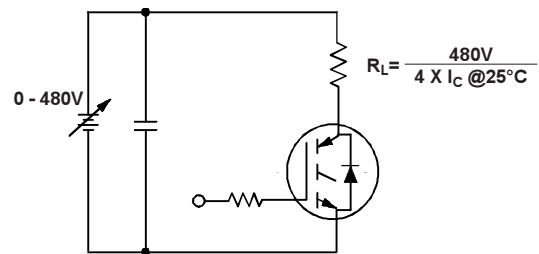
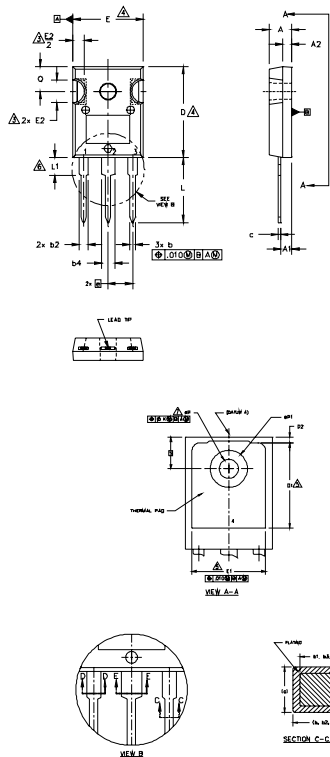

Figure 20. Pulsed Collector Current Test Circuit

# IRG4PC50SDPbF

## TO-247AC Package Outline

Dimensions are shown in millimeters (inches)



**NOTES:**

1. DIMENSIONING AND TOLERANCING AS PER ASME Y14.5M 1994.
2. DIMENSIONS ARE SHOWN IN INCHES.
3. CONTOUR OF SLOT OPTIONAL.
4. DIMENSION D & E DO NOT INCLUDE MOLD FLASH. MOLD FLASH SHALL NOT EXCEED .005" (0.127) PER SIDE. THESE DIMENSIONS ARE MEASURED AT THE OUTERMOST EXTREMES OF THE PLASTIC BODY.
5. THERMAL PAD CONTOUR OPTIONAL WITHIN DIMENSIONS D1 & E1.
6. LEAD FINISH UNCONTROLLED IN LI.
7. ØP TO HAVE A MAXIMUM DRAFT ANGLE OF 1.5° TO THE TOP OF THE PART WITH A MAXIMUM HOLE DIAMETER OF .154 INCH.
8. OUTLINE CONFORMS TO JEDEC OUTLINE TO-247AC .

SYMBOL	DIMENSIONS				NOTES
	INCHES		MILLIMETERS		
	MIN.	MAX.	MIN.	MAX.	
A	.183	.209	4.65	5.31	
A1	.087	.102	2.21	2.59	
A2	.059	.098	1.50	2.49	
b	.039	.055	0.99	1.40	
b1	.039	.053	0.99	1.35	
b2	.065	.094	1.65	2.39	
b3	.065	.092	1.65	2.34	
b4	.102	.135	2.59	3.43	
b5	.102	.133	2.59	3.38	
c	.015	.035	0.38	0.89	
c1	.015	.033	0.38	0.84	
D	.776	.815	19.71	20.70	4
D1	.515	-	13.08	-	5
D2	.020	.053	0.51	1.35	
E	.602	.625	15.29	15.87	4
E1	.530	-	13.46	-	
E2	.178	.216	4.52	5.49	
e	.215 BSC		5.46 BSC		
Øk	.010		0.25		
L	.559	.634	14.20	16.10	
L1	.146	.169	3.71	4.29	
ØP	.140	.144	3.56	3.66	
ØP1	-	.291	-	7.39	
Q	.209	.224	5.31	5.69	
S	.217 BSC		5.51 BSC		

**LEAD ASSIGNMENTS**

**HEXFET**

- 1.- GATE
- 2.- DRAIN
- 3.- SOURCE
- 4.- DRAIN

**IGBTs, CoPACK**

- 1.- GATE
- 2.- COLLECTOR
- 3.- EMITTER
- 4.- COLLECTOR

**DIODES**

- 1.- ANODE/OPEN
- 2.- CATHODE
- 3.- ANODE

## TO-247AC Part Marking Information

EXAMPLE: THIS IS AN IRFPE30  
WITH ASSEMBLY  
LOT CODE 5657  
ASSEMBLED ON WW 35, 2001  
IN THE ASSEMBLY LINE "H"

Note: "P" in assembly line position  
indicates "Lead-Free"

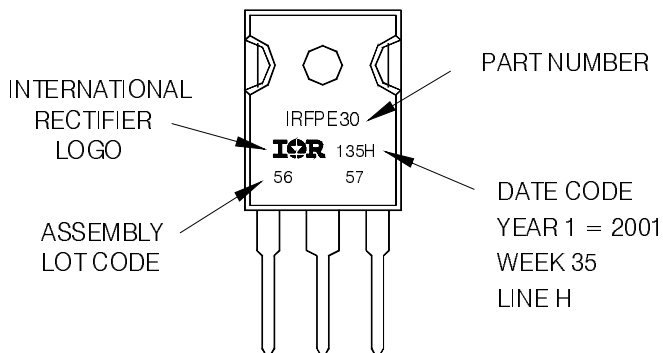

TO-247AC package is not recommended for Surface Mount Application.

Note: For the most current drawing please refer to IR website at <http://www.irf.com/package/>

Data and specifications subject to change without notice.  
This product has been designed and qualified for Industrial market.  
Qualification Standards can be found on IR's Web site.

单击下面可查看定价，库存，交付和生命周期等信息

[>>Infineon Technologies\(英飞凌\)](#)