

**RADIATION HARDENED
 LOGIC LEVEL POWER MOSFET
 SURFACE MOUNT (LCC-28)**

**2N7615U6
 IRHLQ77214
 250V, Quad N-CHANNEL**

Product Summary

Part Number	Radiation Level	R _{DS(on)}	I _D
IRHLQ77214	100K Rads (Si)	1.0Ω	2.6A
IRHLQ73214	300K Rads (Si)	1.0Ω	2.6A



International Rectifier's R7™ Logic Level Power MOSFETs provide simple solution to interfacing CMOS and TTL control circuits to power devices in space and other radiation environments. The threshold voltage remains within acceptable operating limits over the full operating temperature and post radiation. This is achieved while maintaining single event gate rupture and single event burnout immunity. These devices are used in applications such as current boost low signal source in PWM, voltage comparator and operational amplifiers.

Features:

- 5V CMOS and TTL Compatible
- Fast Switching
- Single Event Effect (SEE) Hardened
- Low Total Gate Charge
- Simple Drive Requirements
- Ease of Paralleling
- Hermetically Sealed
- Ceramic Package
- Surface Mount
- Light Weight

Absolute Maximum Ratings (Per Die)

Pre-Irradiation

	Parameter		Units
I _D @ V _{GS} = 4.5V, T _C = 25°C	Continuous Drain Current	2.6	A
I _D @ V _{GS} = 4.5V, T _C = 100°C	Continuous Drain Current	1.6	
I _{DM}	Pulsed Drain Current ①	10.4	
P _D @ T _C = 25°C	Max. Power Dissipation	12	W
	Linear Derating Factor	0.1	W/°C
V _{GS}	Gate-to-Source Voltage	±10	V
EAS	Single Pulse Avalanche Energy ②	38.5	mJ
I _{AR}	Avalanche Current ①	2.6	A
EAR	Repetitive Avalanche Energy ①	1.2	mJ
dv/dt	Peak Diode Recovery dv/dt ③	5.56	V/ns
T _J	Operating Junction	-55 to 150	°C
T _{STG}	Storage Temperature Range		
	Pckg. Mounting Surface Temp.	300 (for 5s)	
	Weight	0.89 (Typical)	g

For footnotes refer to the last page

www.irf.com

Electrical Characteristics @ T_j = 25°C (Per Die) (Unless Otherwise Specified)

	Parameter	Min	Typ	Max	Units	Test Conditions
B _V D _{SS}	Drain-to-Source Breakdown Voltage	250	—	—	V	V _{GS} = 0V, I _D = 250μA
ΔB _V D _{SS} /ΔT _J	Temperature Coefficient of Breakdown Voltage	—	0.25	—	V/°C	Reference to 25°C, I _D = 1.0mA
R _{DS(on)}	Static Drain-to-Source On-State Resistance	—	—	1.0	Ω	V _{GS} = 4.5V, I _D = 1.6A ④
V _{GS(th)}	Gate Threshold Voltage	1.0	—	2.0	V	V _{DS} = V _{GS} , I _D = 250μA
ΔV _{GS(th)} /ΔT _J	Gate Threshold Voltage Coefficient	—	-5.3	—	mV/°C	
g _{fs}	Forward Transconductance	2.5	—	—	S	V _{DS} = 15V, I _{DS} = 1.6A ④
I _{DSS}	Zero Gate Voltage Drain Current	—	—	1.0	μA	V _{DS} = 200V, V _{GS} = 0V
		—	—	10		V _{DS} = 200V, V _{GS} = 0V, T _J = 125°C
I _{GSS}	Gate-to-Source Leakage Forward	—	—	100	nA	V _{GS} = 10V
I _{GSS}	Gate-to-Source Leakage Reverse	—	—	-100		V _{GS} = -10V
Q _g	Total Gate Charge	—	—	18	nC	V _{GS} = 4.5V, I _D = 2.6A V _{DS} = 125V
Q _{gs}	Gate-to-Source Charge	—	—	5.0		
Q _{gd}	Gate-to-Drain ('Miller') Charge	—	—	12		
t _{d(on)}	Turn-On Delay Time	—	—	27	ns	V _{DD} = 125V, I _D = 2.6A, V _{GS} = 5.0V, R _G = 7.5Ω
t _r	Rise Time	—	—	57		
t _{d(off)}	Turn-Off Delay Time	—	—	45		
t _f	Fall Time	—	—	55		
L _S + L _D	Total Inductance	—	6.1	—	nH	Measured from the center of drain pad to center of source pad
C _{iss}	Input Capacitance	—	605	—	pF	V _{GS} = 0V, V _{DS} = 25V f = 1.0MHz
C _{oss}	Output Capacitance	—	62	—		
C _{rss}	Reverse Transfer Capacitance	—	0.7	—		
R _g	Gate Resistance	—	8.0	—	Ω	f = 1.0MHz, open drain

Source-Drain Diode Ratings and Characteristics (Per Die)

	Parameter	Min	Typ	Max	Units	Test Conditions
I _S	Continuous Source Current (Body Diode)	—	—	2.6	A	T _j = 25°C, I _S = 2.6A, V _{GS} = 0V ④
I _{SM}	Pulse Source Current (Body Diode) ①	—	—	10.4		
V _{SD}	Diode Forward Voltage	—	—	1.2	V	T _j = 25°C, I _F = 2.6A, di/dt ≤ 100A/μs
t _{rr}	Reverse Recovery Time	—	—	371	ns	V _{DD} ≤ 25V ④
Q _{RR}	Reverse Recovery Charge	—	—	858	nC	
t _{on}	Forward Turn-On Time	Intrinsic turn-on time is negligible. Turn-on speed is substantially controlled by L _S + L _D .				

Thermal Resistance (Per Die)

	Parameter	Min	Typ	Max	Units	Test Conditions
R _{thJ-PCB}	Junction-to-PCB	—	—	10.4	°C/W	Typical socket mount
R _{thJA}	Junction-to-Ambient	—	—	90		

Note: Corresponding Spice and Saber models are available International Rectifier Website.

For footnotes refer to the last page

Radiation Characteristics

IRHLQ77214, 2N7615U6

International Rectifier Radiation Hardened MOSFETs are tested to verify their radiation hardness capability. The hardness assurance program at International Rectifier is comprised of two radiation environments. Every manufacturing lot is tested for total ionizing dose (per notes 5 and 6) using the TO-3 package. Both pre- and post-irradiation performance are tested and specified using the same drive circuitry and test conditions in order to provide a direct comparison.

Table 1. Electrical Characteristics @ Tj = 25°C, Post Total Dose Irradiation ⑤⑥ (Per Die)

	Parameter	Up to 300K Rads (Si) ¹		Units	Test Conditions
		Min	Max		
BV _{DSS}	Drain-to-Source Breakdown Voltage	250	—	V	V _{GS} = 0V, I _D = 250μA
V _{GS(th)}	Gate Threshold Voltage	1.0	2.0		V _{GS} = V _{DS} , I _D = 250μA
I _{GSS}	Gate-to-Source Leakage Forward	—	100	nA	V _{GS} = 10V
I _{GSS}	Gate-to-Source Leakage Reverse	—	-100		V _{GS} = -10V
I _{DSS}	Zero Gate Voltage Drain Current	—	10	μA	V _{DS} = 200V, V _{GS} = 0V
R _{DS(on)}	Static Drain-to-Source On-State Resistance (TO-3) ④	—	0.85	Ω	V _{GS} = 4.5V, I _D = 1.6A
R _{DS(on)}	Static Drain-to-Source On-state Resistance (LCC-28) ④	—	1.0	Ω	V _{GS} = 4.5V, I _D = 1.6A
V _{SD}	Diode Forward Voltage④	—	1.2	V	V _{GS} = 0V, I _D = 2.6A

1. Part numbers IRHLQ77214, IRHLQ73214

International Rectifier radiation hardened MOSFETs have been characterized in heavy ion environment for Single Event Effects (SEE). Single Event Effects characterization is illustrated in Fig. a and Table 2.

Table 2. Typical Single Event Effect Safe Operating Area

LET (MeV/(mg/cm ²))	Energy (MeV)	Range (μm)	VDS (V)					
			@VGS=0V	@VGS=-2V	@VGS=-4V	@VGS=-5V	@VGS=-6V	@VGS=-7V
38 ± 5%	300 ± 7.5%	38 ± 7.5%	250	250	250	250	250	250
62 ± 5%	355 ± 7.5%	33 ± 7.5%	250	250	250	250	250	-
85 ± 5%	380 ± 7.5%	29 ± 7.5%	250	250	250	250	-	-

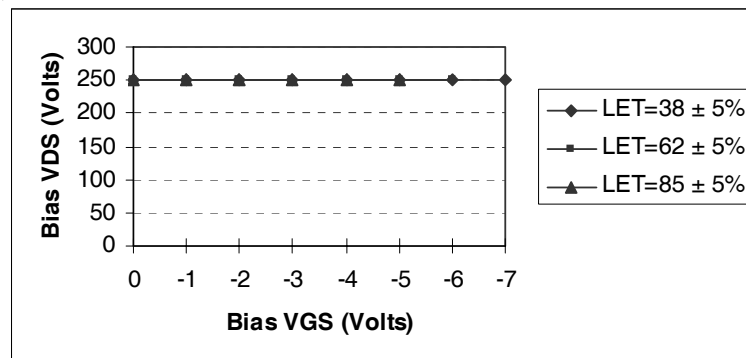
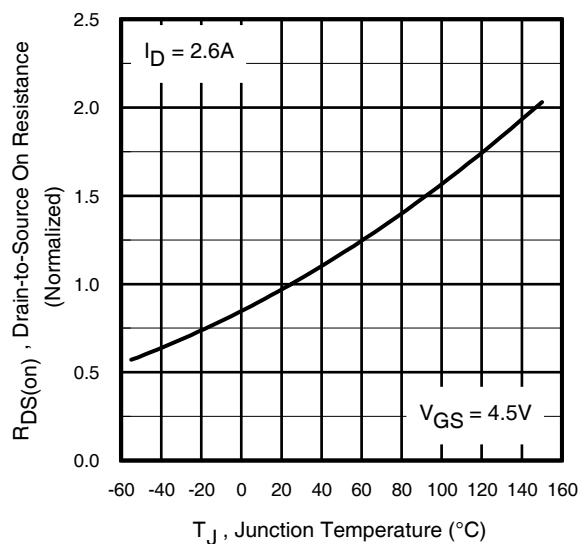
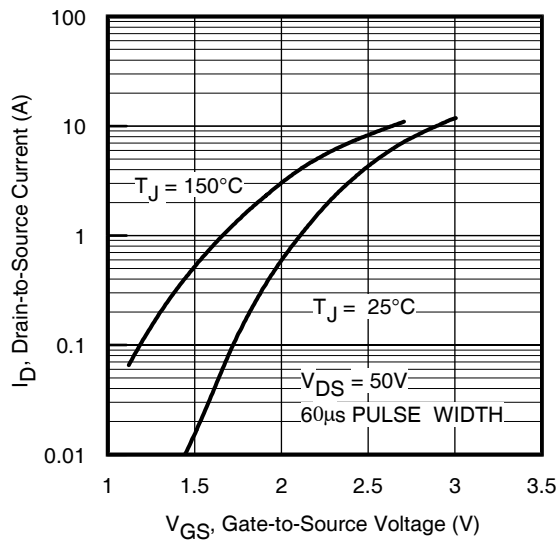
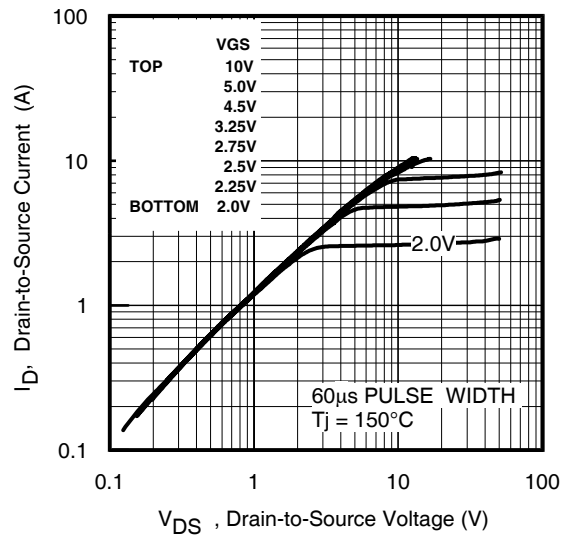
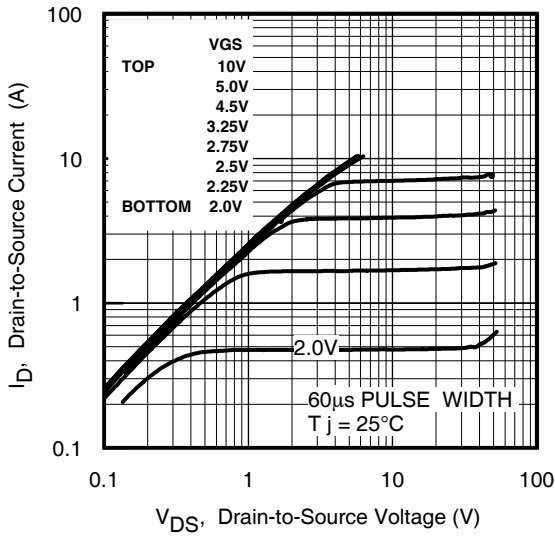

Fig a. Typical Single Event Effect, Safe Operating Area

For footnotes refer to the last page



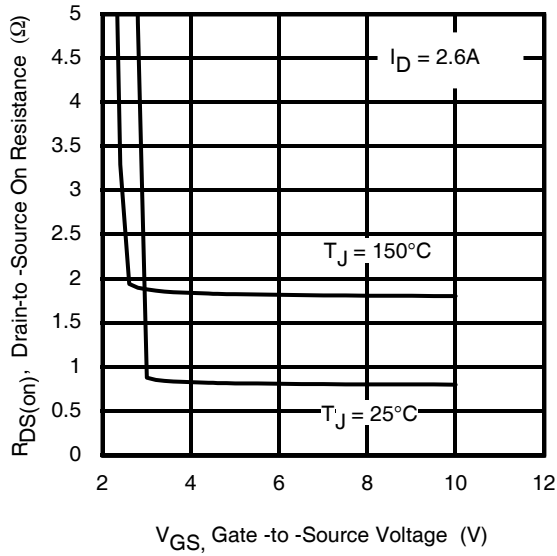

Fig 5. Typical On-Resistance Vs Gate Voltage

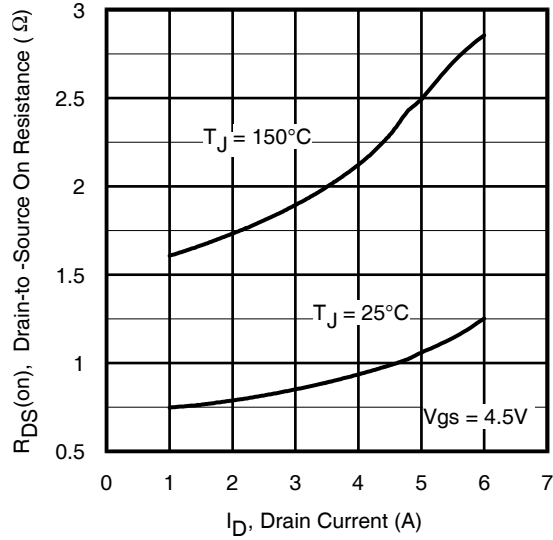

Fig 6. Typical On-Resistance Vs Drain Current

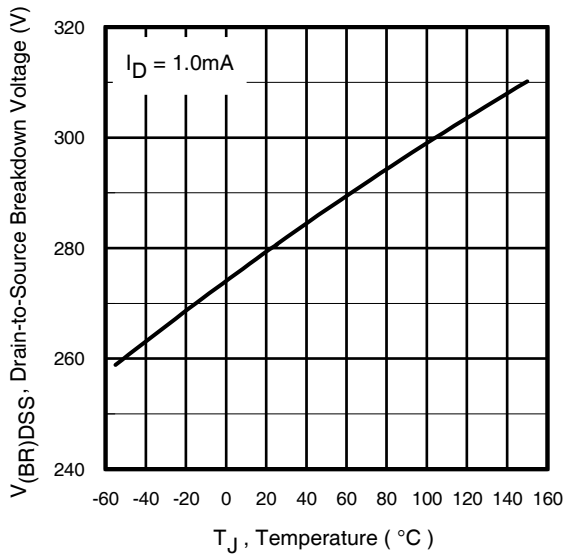

Fig 7. Typical Drain-to-Source Breakdown Voltage Vs Temperature

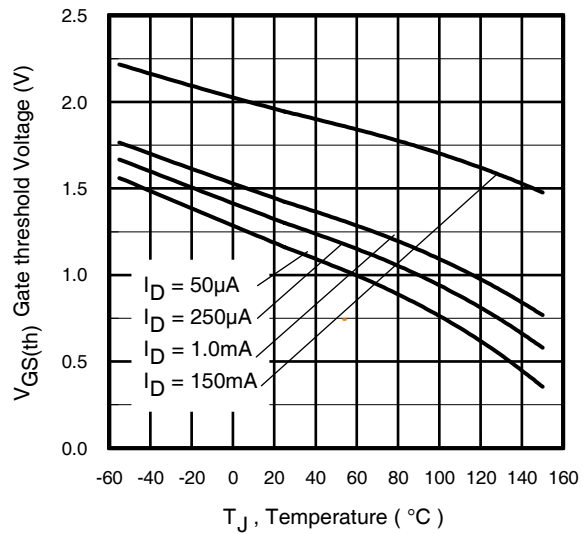

Fig 8. Typical Threshold Voltage Vs Temperature

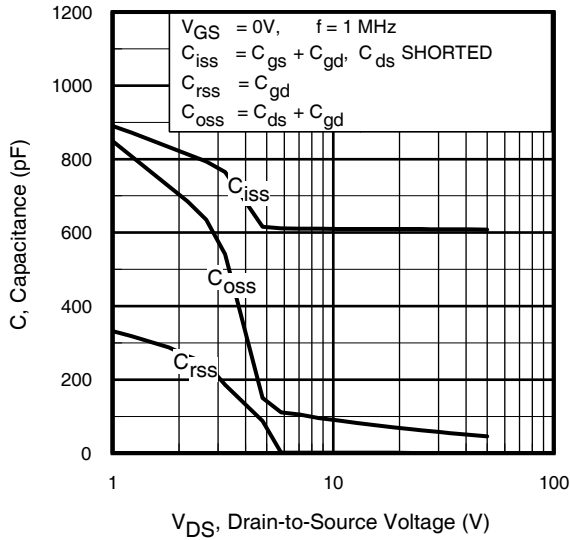

Fig 9. Typical Capacitance Vs. Drain-to-Source Voltage

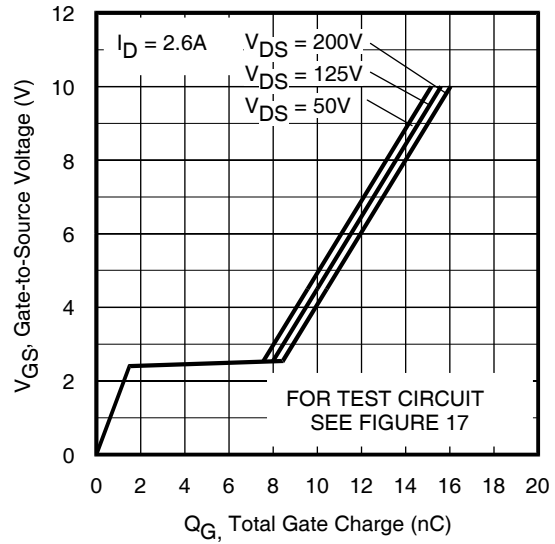

Fig 10. Typical Gate Charge Vs. Gate-to-Source Voltage

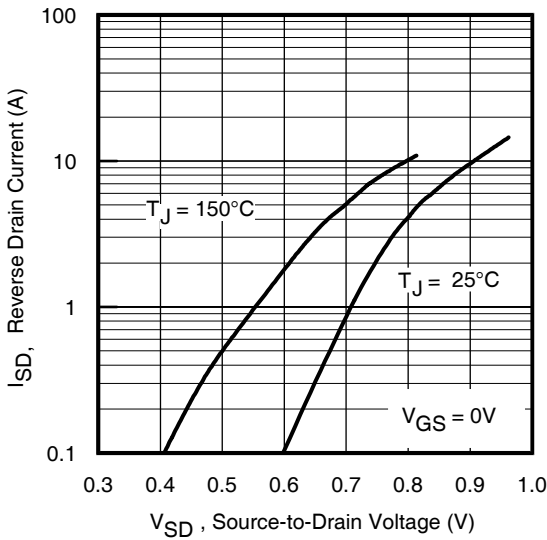

Fig 11. Typical Source-to-Drain Diode Forward Voltage

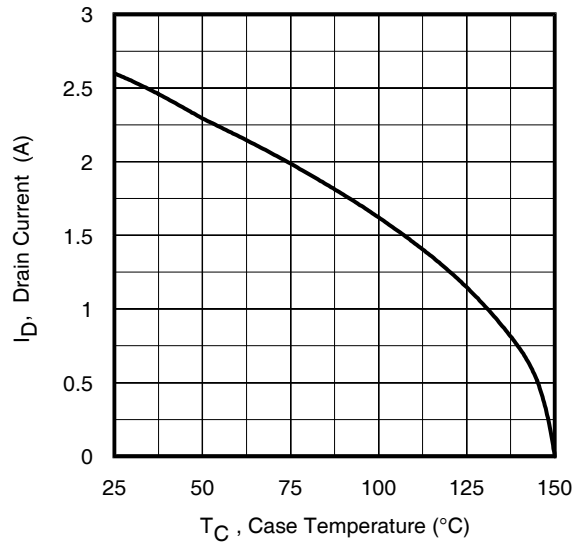

Fig 12. Maximum Drain Current Vs. Case Temperature

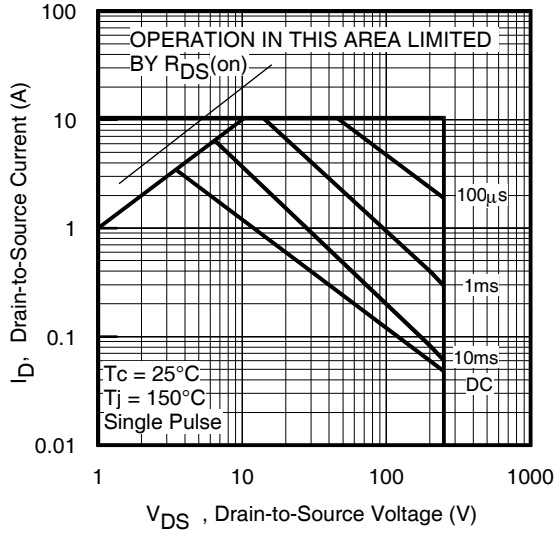

Fig 13. Maximum Safe Operating Area

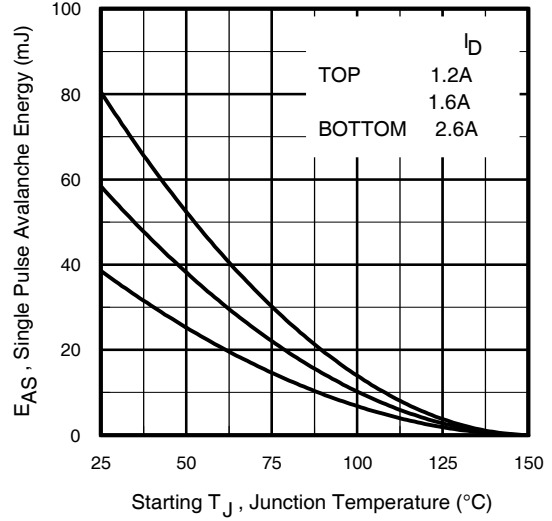

Fig 14. Maximum Avalanche Energy Vs. Drain Current

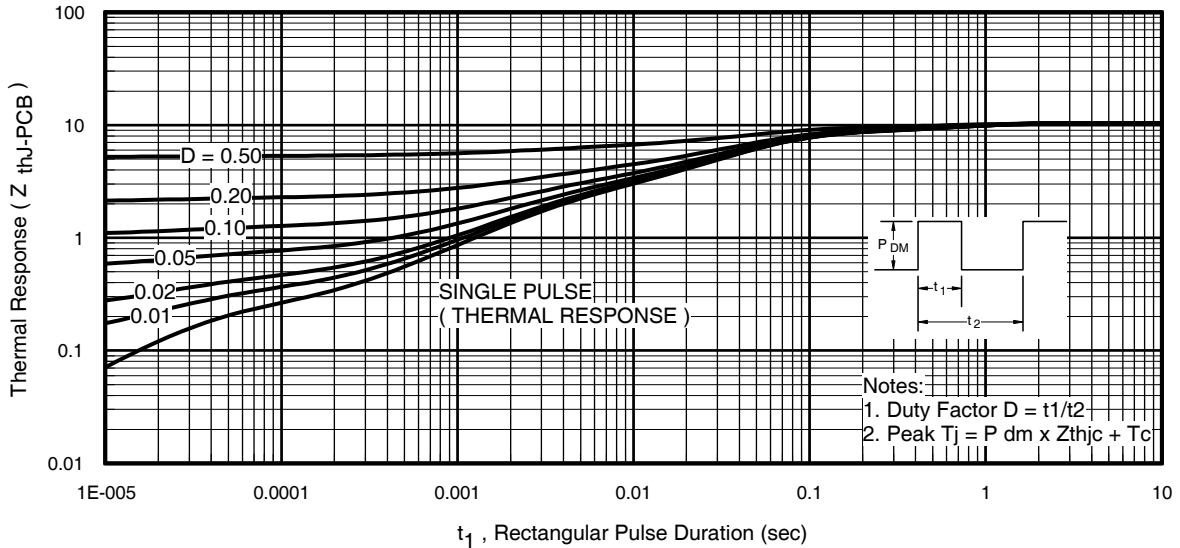

Fig 15. Maximum Effective Transient Thermal Impedance, Junction-to-PCB

IRHLQ77214, 2N7615U6

Pre-Irradiation

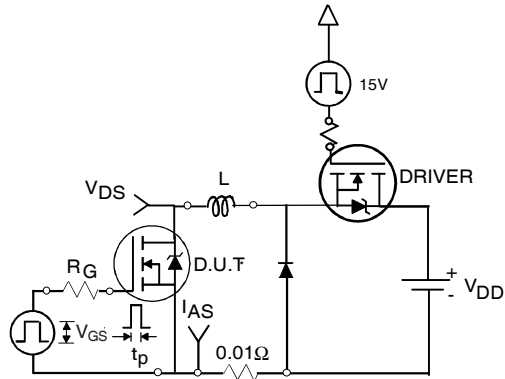

Fig 16a. Unclamped Inductive Test Circuit

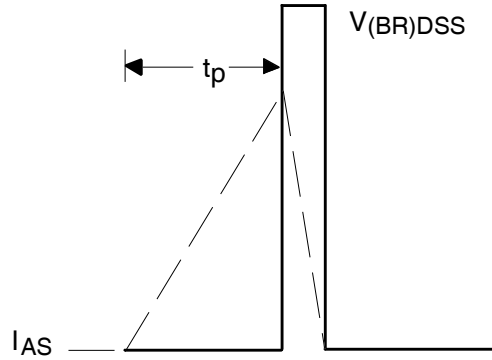

Fig 16b. Unclamped Inductive Waveforms

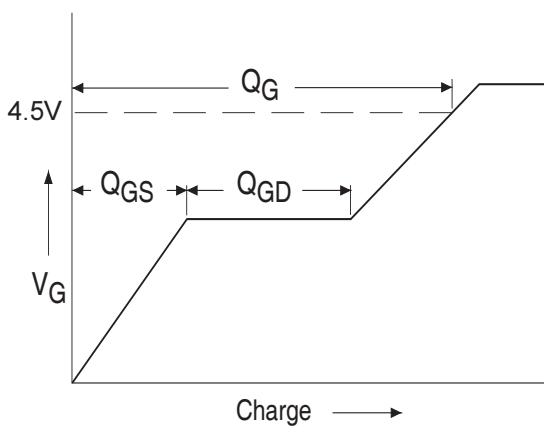

Fig 17a. Basic Gate Charge Waveform

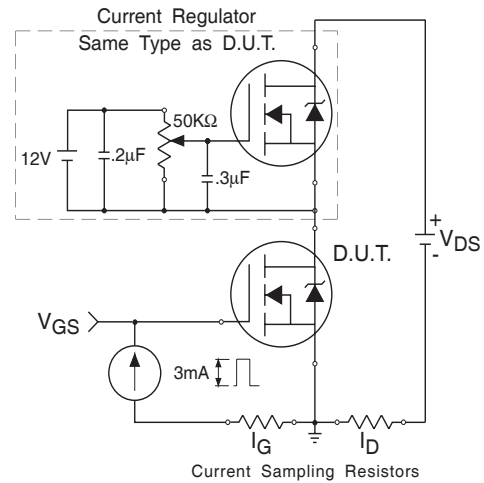

Fig 17b. Gate Charge Test Circuit

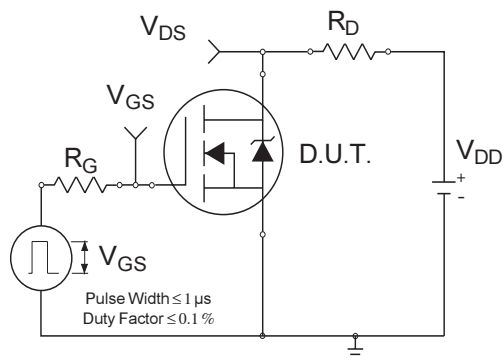

Fig 18a. Switching Time Test Circuit

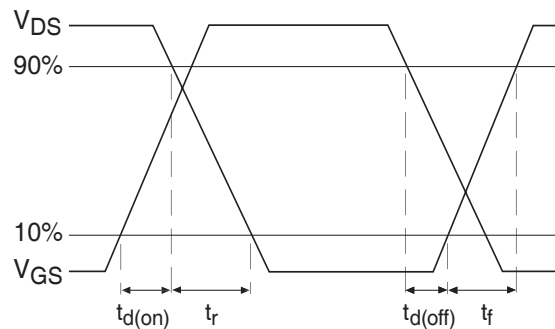

Fig 18b. Switching Time Waveforms

Pre-Irradiation

IRHLQ77214, 2N7615U6

Footnotes:

- ① Repetitive Rating; Pulse width limited by maximum junction temperature.
- ② $V_{DD} = 50V$, starting $T_J = 25^\circ C$, $L = 11.4mH$
Peak $I_L = 2.6A$, $V_{GS} = 10V$
- ③ $I_{SD} \leq 2.6A$, $di/dt \leq 399A/\mu s$,
 $V_{DD} \leq 250V$, $T_J \leq 150^\circ C$
- ④ Pulse width $\leq 300 \mu s$; Duty Cycle $\leq 2\%$
- ⑤ **Total Dose Irradiation with V_{GS} Bias.**
10 volt V_{GS} applied and $V_{DS} = 0$ during irradiation per MIL-STD-750, method 1019, condition A.
- ⑥ **Total Dose Irradiation with V_{DS} Bias.**
200 volt V_{DS} applied and $V_{GS} = 0$ during irradiation per MIL-STD-750, method 1019, condition A.

Case Outline and Dimensions — LCC-28

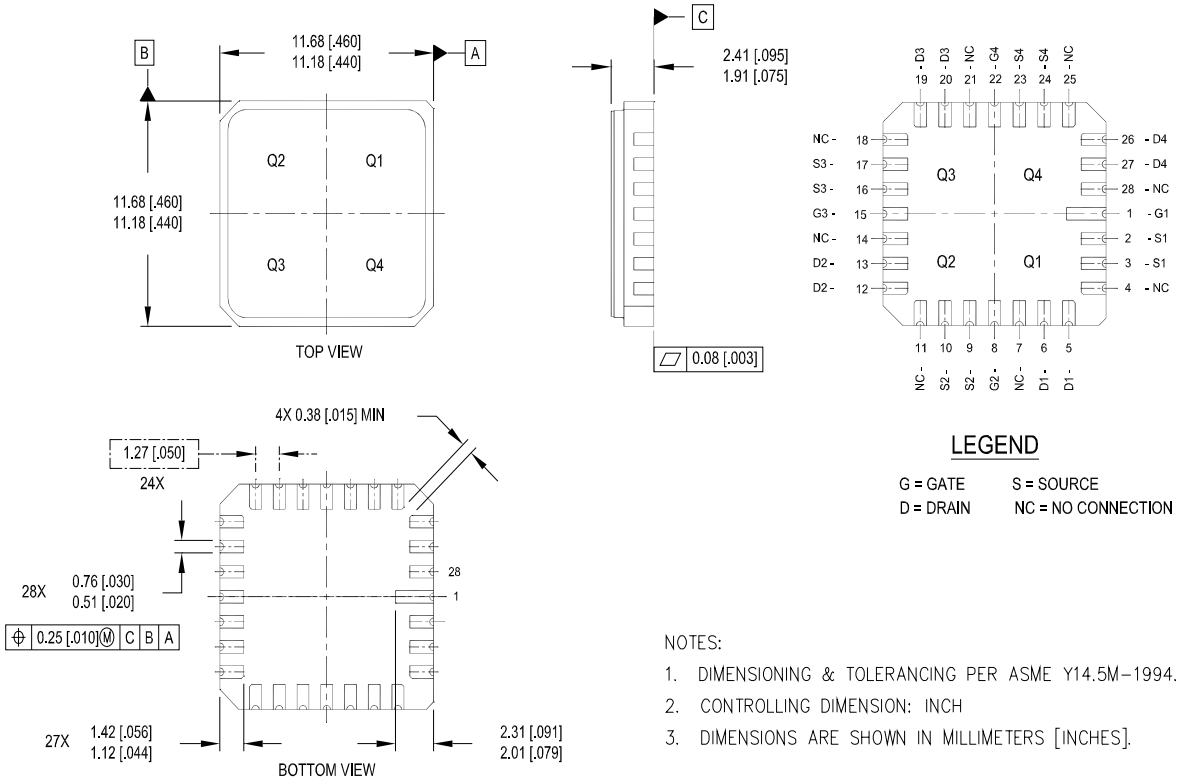

International
IR Rectifier

IR WORLD HEADQUARTERS: 233 Kansas St., El Segundo, California 90245, USA Tel: (310) 252-7105

IR LEOMINSTER : 205 Crawford St., Leominster, Massachusetts 01453, USA Tel: (978) 534-5776

TAC Fax: (310) 252-7903

Visit us at www.irf.com for sales contact information.

Data and specifications subject to change without notice. 02/2011

单击下面可查看定价，库存，交付和生命周期等信息

[>>Infineon Technologies\(英飞凌\)](#)