

**Applications**

- High Frequency DC-DC Isolated Converters with Synchronous Rectification for Telecom and Industrial Use
- High Frequency Buck Converters for Computer Processor Power
- Lead-Free

**Benefits**

- Ultra-Low Gate Impedance
- Very Low  $R_{DS(on)}$  at 4.5V  $V_{GS}$
- Fully Characterized Avalanche Voltage and Current

HEXFET® Power MOSFET

$V_{DSS}$	$R_{DS(on)}$ max	$I_D$
30V	12mΩ	62A

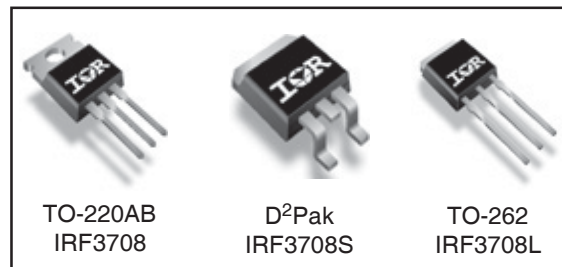

**Absolute Maximum Ratings**

Symbol	Parameter	Max.	Units
$V_{DS}$	Drain-Source Voltage	30	V
$V_{GS}$	Gate-to-Source Voltage	±12	V
$I_D @ T_C = 25^\circ C$	Continuous Drain Current, $V_{GS} @ 10V$	62	A
$I_D @ T_C = 70^\circ C$	Continuous Drain Current, $V_{GS} @ 10V$	52	
$I_{DM}$	Pulsed Drain Current <sup>①</sup>	248	
$P_D @ T_C = 25^\circ C$	Maximum Power Dissipation <sup>③</sup>	87	W
$P_D @ T_C = 70^\circ C$	Maximum Power Dissipation <sup>③</sup>	61	W
	Linear Derating Factor	0.58	W/°C
$T_J, T_{STG}$	Junction and Storage Temperature Range	-55 to + 175	°C

**Thermal Resistance**

	Parameter	Typ.	Max.	Units
$R_{\theta JC}$	Junction-to-Case	—	1.73	°C/W
$R_{\theta CS}$	Case-to-Sink, Flat, Greased Surface <sup>④</sup>	0.50	—	
$R_{\theta JA}$	Junction-to-Ambient <sup>④</sup>	—	62	
$R_{\theta JA}$	Junction-to-Ambient (PCB mount)*	—	40	

\* When mounted on 1" square PCB (FR-4 or G-10 Material) .  
For recommended footprint and soldering techniques refer to application note #AN-994

Notes ① through ④ are on page 10

www.irf.com

# IRF3708/S/LPbF

International  
**IR** Rectifier

## Static @ T<sub>J</sub> = 25°C (unless otherwise specified)

	Parameter	Min.	Typ.	Max.	Units	Conditions
V <sub>(BR)DSS</sub>	Drain-to-Source Breakdown Voltage	30	—	—	V	V <sub>GS</sub> = 0V, I <sub>D</sub> = 250μA
ΔV <sub>(BR)DSS</sub> /ΔT <sub>J</sub>	Breakdown Voltage Temp. Coefficient	—	0.028	—	V/°C	Reference to 25°C, I <sub>D</sub> = 1mA
R <sub>DS(on)</sub>	Static Drain-to-Source On-Resistance	—	8	12.0	mΩ	V <sub>GS</sub> = 10V, I <sub>D</sub> = 15A ③
		—	9.5	13.5		V <sub>GS</sub> = 4.5V, I <sub>D</sub> = 12A ③
		—	14.5	29		V <sub>GS</sub> = 2.8V, I <sub>D</sub> = 7.5A ③
V <sub>GS(th)</sub>	Gate Threshold Voltage	0.6	—	2.0	V	V <sub>DS</sub> = V <sub>GS</sub> , I <sub>D</sub> = 250μA
I <sub>DSS</sub>	Drain-to-Source Leakage Current	—	—	20	μA	V <sub>DS</sub> = 24V, V <sub>GS</sub> = 0V
		—	—	100		V <sub>DS</sub> = 24V, V <sub>GS</sub> = 0V, T <sub>J</sub> = 125°C
I <sub>GSS</sub>	Gate-to-Source Forward Leakage	—	—	200	nA	V <sub>GS</sub> = 12V
	Gate-to-Source Reverse Leakage	—	—	-200		V <sub>GS</sub> = -12V

## Dynamic @ T<sub>J</sub> = 25°C (unless otherwise specified)

Symbol	Parameter	Min.	Typ.	Max.	Units	Conditions
g <sub>fs</sub>	Forward Transconductance	49	—	—	S	V <sub>DS</sub> = 15V, I <sub>D</sub> = 50A
Q <sub>g</sub>	Total Gate Charge	—	24	—	nC	I <sub>D</sub> = 24.8A
Q <sub>gs</sub>	Gate-to-Source Charge	—	6.7	—		V <sub>DS</sub> = 15V
Q <sub>gd</sub>	Gate-to-Drain ("Miller") Charge	—	5.8	—		V <sub>GS</sub> = 4.5V ③
Q <sub>oss</sub>	Output Gate Charge	—	14	21		V <sub>GS</sub> = 0V, I <sub>D</sub> = 24.8A, V <sub>DS</sub> = 15V
t <sub>d(on)</sub>	Turn-On Delay Time	—	7.2	—	ns	V <sub>DD</sub> = 15V
t <sub>r</sub>	Rise Time	—	50	—		I <sub>D</sub> = 24.8A
t <sub>d(off)</sub>	Turn-Off Delay Time	—	17.6	—		R <sub>G</sub> = 0.6Ω
t <sub>f</sub>	Fall Time	—	3.7	—		V <sub>GS</sub> = 4.5V ③
C <sub>iss</sub>	Input Capacitance	—	2417	—	pF	V <sub>GS</sub> = 0V
C <sub>oss</sub>	Output Capacitance	—	707	—		V <sub>DS</sub> = 15V
C <sub>rss</sub>	Reverse Transfer Capacitance	—	52	—		f = 1.0MHz

## Avalanche Characteristics

Symbol	Parameter	Typ.	Max.	Units
E <sub>AS</sub>	Single Pulse Avalanche Energy②	—	213	mJ
I <sub>AR</sub>	Avalanche Current①	—	62	A

## Diode Characteristics

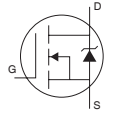
Symbol	Parameter	Min.	Typ.	Max.	Units	Conditions
I <sub>S</sub>	Continuous Source Current (Body Diode)	—	—	62	A	MOSFET symbol showing the integral reverse p-n junction diode. 
I <sub>SM</sub>	Pulsed Source Current (Body Diode) ①	—	—	248		
V <sub>SD</sub>	Diode Forward Voltage	—	0.88	1.3	V	T <sub>J</sub> = 25°C, I <sub>S</sub> = 31A, V <sub>GS</sub> = 0V ③
		—	0.80	—		T <sub>J</sub> = 125°C, I <sub>S</sub> = 31A, V <sub>GS</sub> = 0V ③
t <sub>rr</sub>	Reverse Recovery Time	—	41	62	ns	T <sub>J</sub> = 25°C, I <sub>F</sub> = 31A, V <sub>R</sub> = 20V
Q <sub>rr</sub>	Reverse Recovery Charge	—	64	96	nC	di/dt = 100A/μs ③
t <sub>rr</sub>	Reverse Recovery Time	—	43	65	ns	T <sub>J</sub> = 125°C, I <sub>F</sub> = 31A, V <sub>R</sub> = 20V
Q <sub>rr</sub>	Reverse Recovery Charge	—	70	105	nC	di/dt = 100A/μs ③

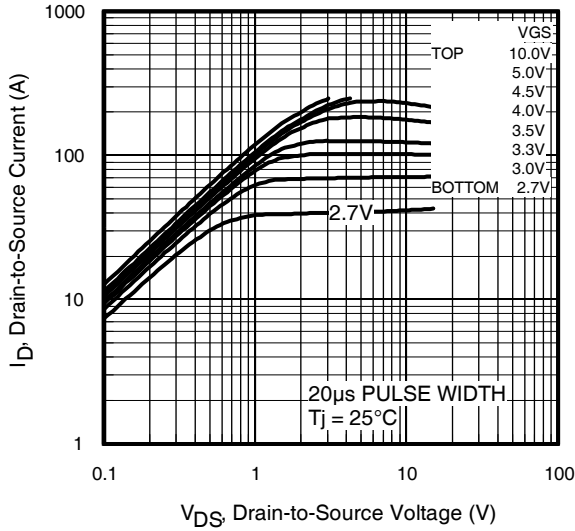

**Fig 1.** Typical Output Characteristics

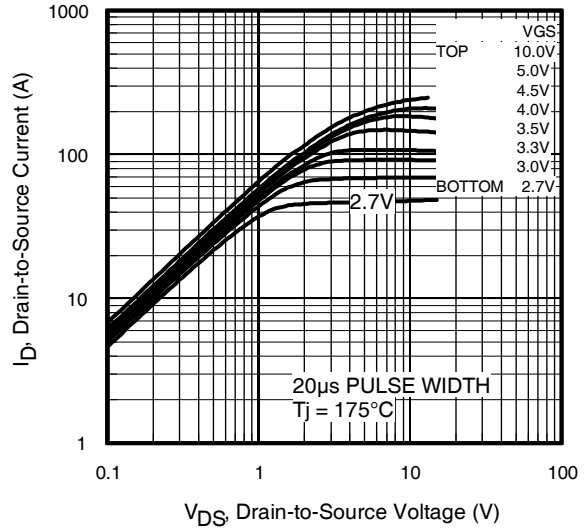

**Fig 2.** Typical Output Characteristics

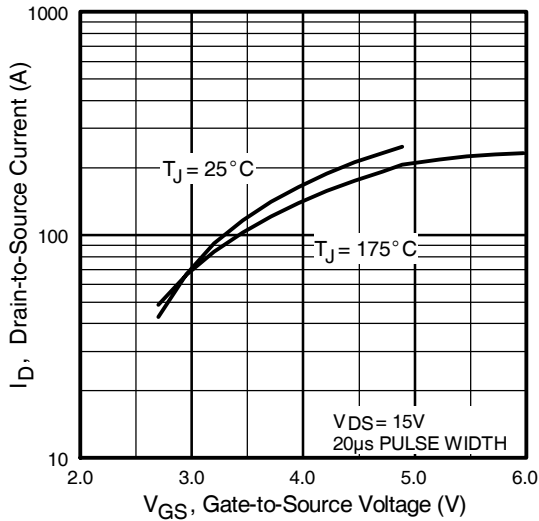

**Fig 3.** Typical Transfer Characteristics

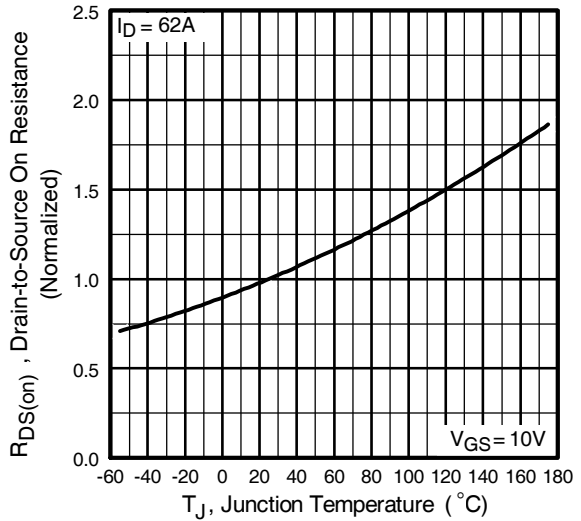

**Fig 4.** Normalized On-Resistance Vs. Temperature

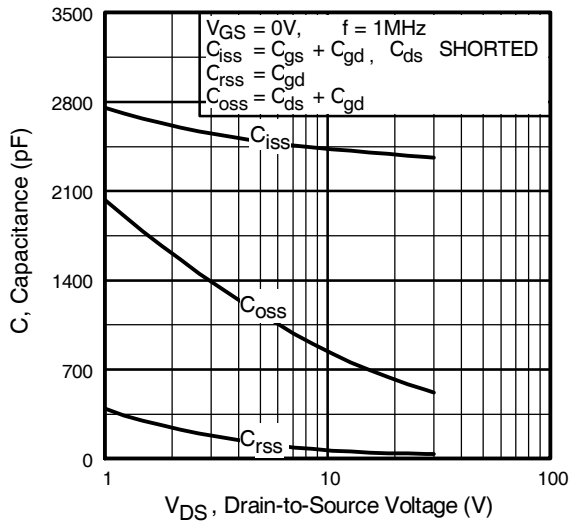

**Fig 5.** Typical Capacitance Vs. Drain-to-Source Voltage

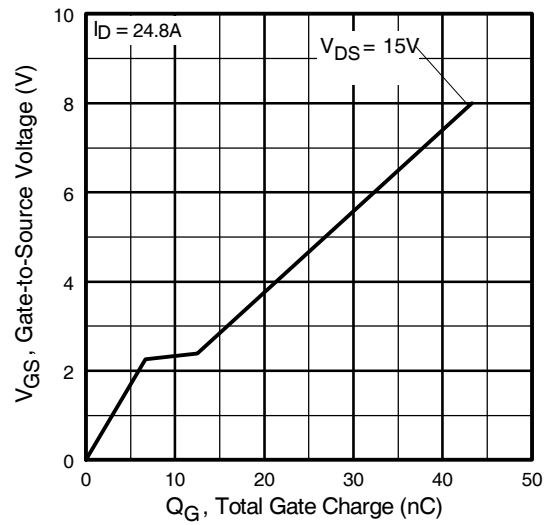

**Fig 6.** Typical Gate Charge Vs. Gate-to-Source Voltage

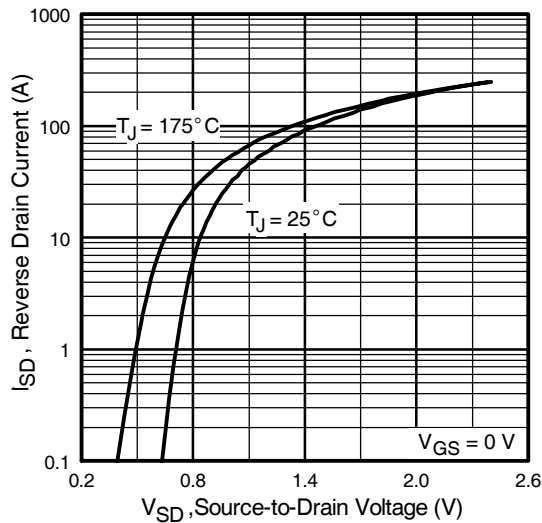

**Fig 7.** Typical Source-Drain Diode Forward Voltage

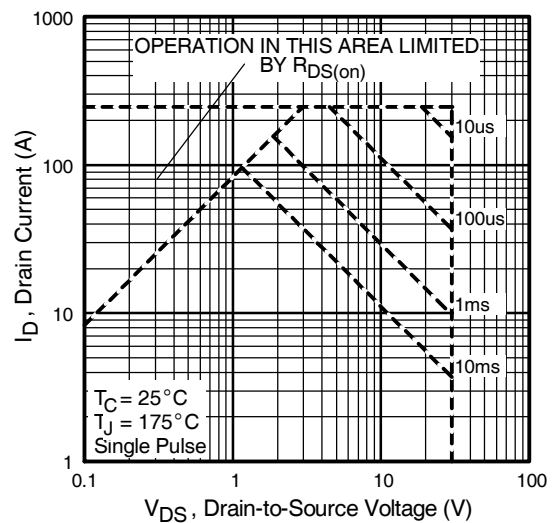

**Fig 8.** Maximum Safe Operating Area

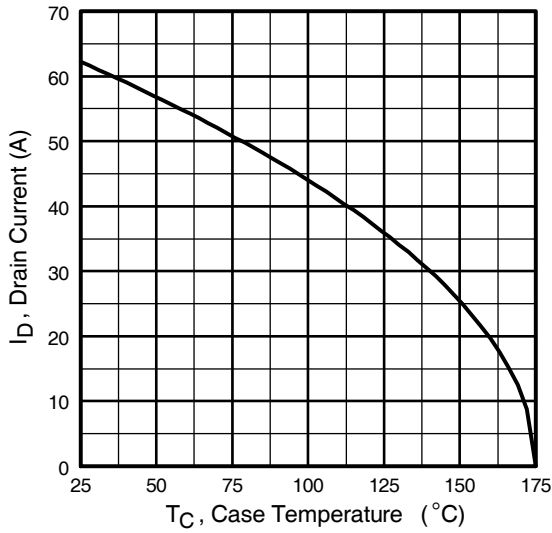

**Fig 9.** Maximum Drain Current Vs. Case Temperature

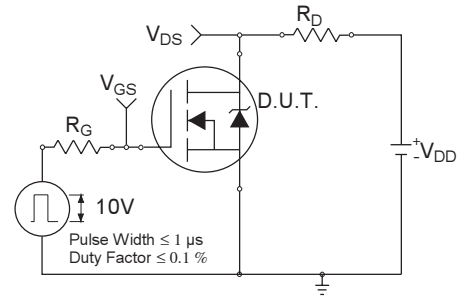

**Fig 10a.** Switching Time Test Circuit

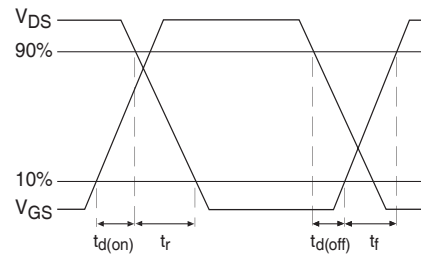

**Fig 10b.** Switching Time Waveforms

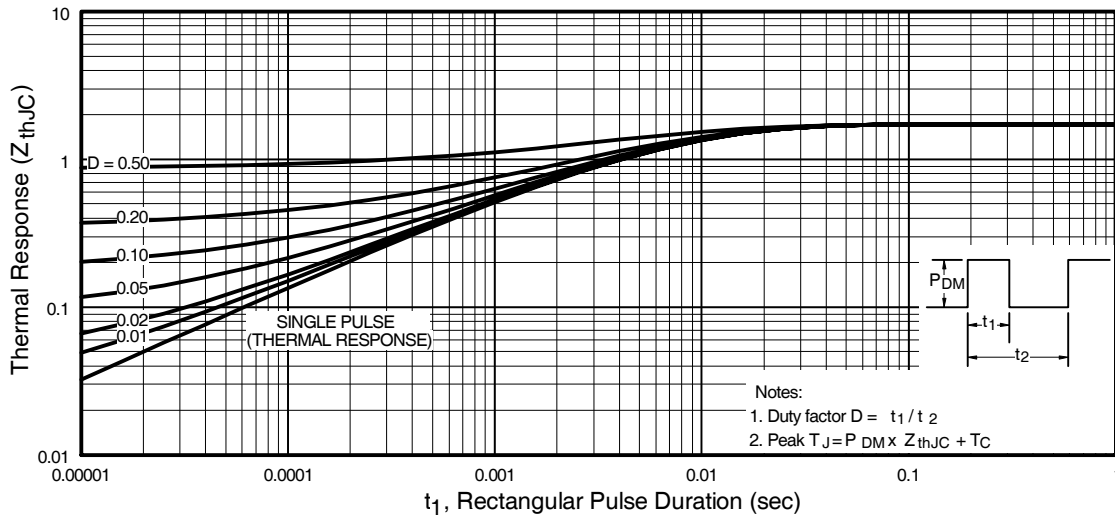

**Fig 11.** Maximum Effective Transient Thermal Impedance, Junction-to-Case

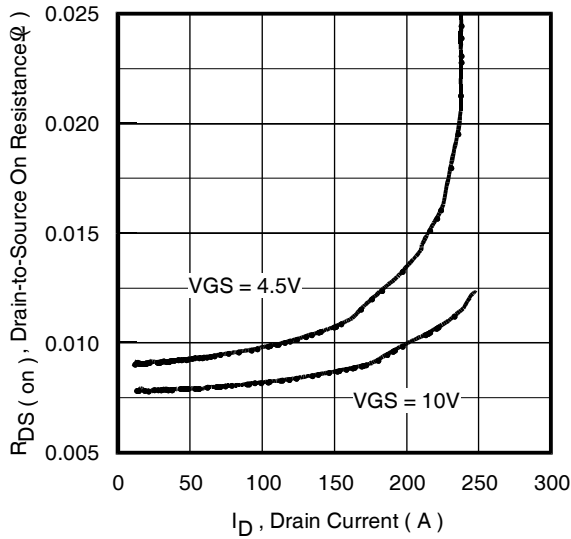

**Fig 12.** On-Resistance Vs. Drain Current

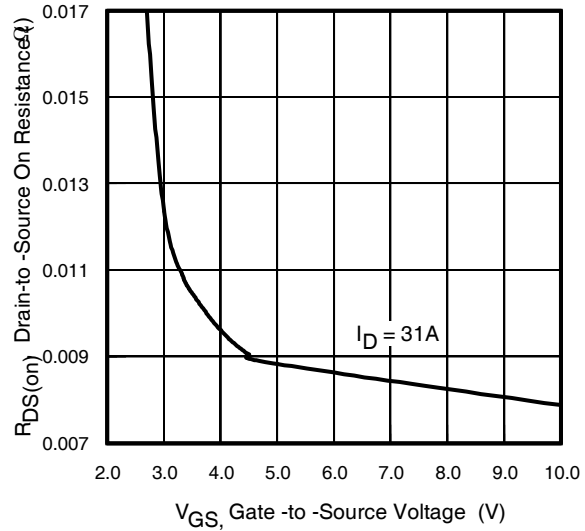

**Fig 13.** On-Resistance Vs. Gate Voltage

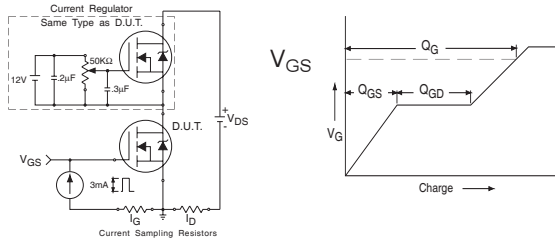

**Fig 14a&b.** Gate Charge Test Circuit and Waveform

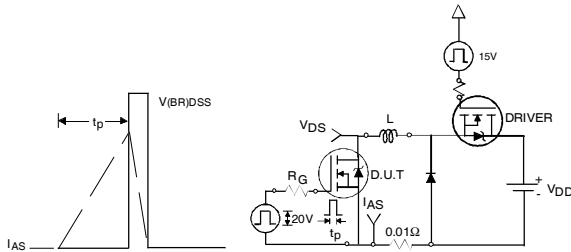

**Fig 15a&b.** Unclamped Inductive Test circuit and Waveforms

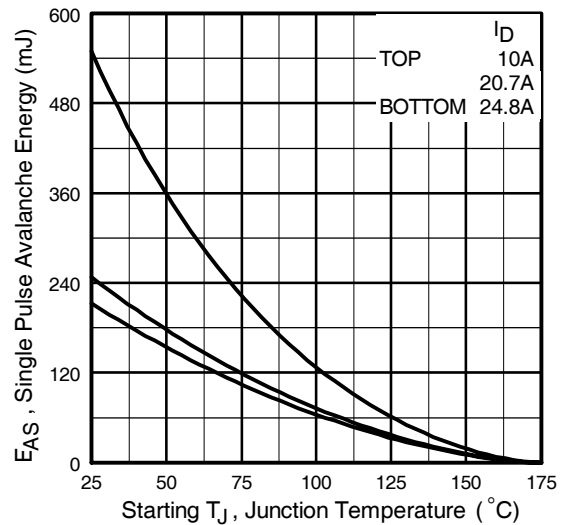

**Fig 15c.** Maximum Avalanche Energy Vs. Drain Current

## TO-220AB Package Outline

Dimensions are shown in millimeters (inches)

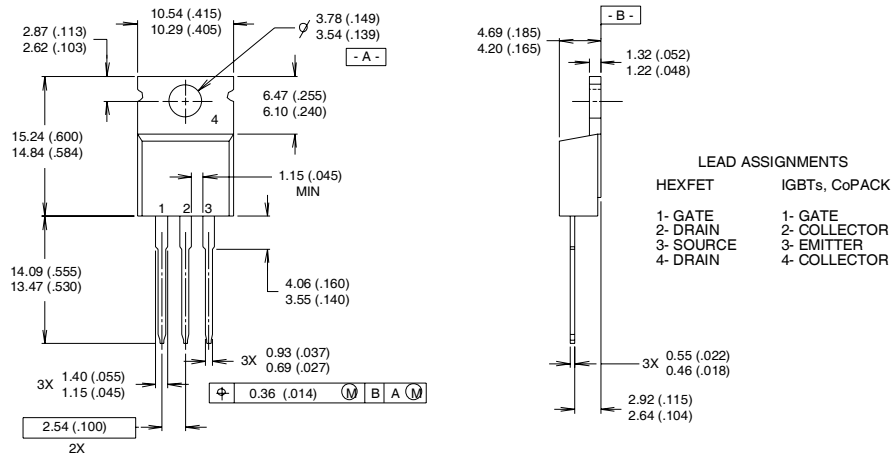

- NOTES:
- 1 DIMENSIONING & TOLERANCING PER ANSI Y14.5M, 1982.
  - 2 CONTROLLING DIMENSION : INCH
  - 3 OUTLINE CONFORMS TO JEDEC OUTLINE TO-220AB.
  - 4 HEATSINK & LEAD MEASUREMENTS DO NOT INCLUDE BURRS.

## TO-220AB Part Marking Information

EXAMPLE: THIS IS AN IRF1010  
 LOT CODE 1789  
 ASSEMBLED ON WW 19, 1997  
 IN THE ASSEMBLY LINE "C"  
**Note:** "P" in assembly line  
 position indicates "Lead-Free"

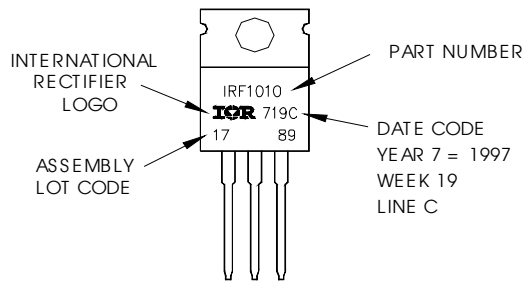

# IRF3708/S/LPbF

International  
**IR** Rectifier

## D<sup>2</sup>Pak Package Outline

Dimensions are shown in millimeters (inches)

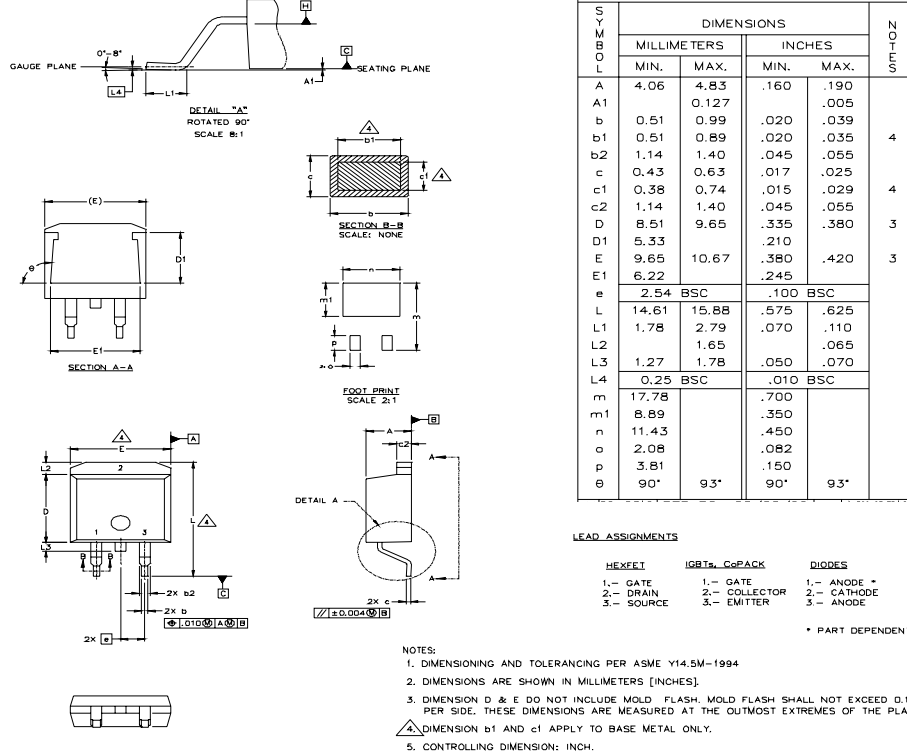

## D<sup>2</sup>Pak Part Marking Information (Lead-Free)

EXAMPLE: THIS IS AN IRF530S WITH  
LOT CODE 8024  
ASSEMBLED ON WW 02, 2000  
IN THE ASSEMBLY LINE "L"

Note: "P" in assembly line  
position indicates "Lead-Free"

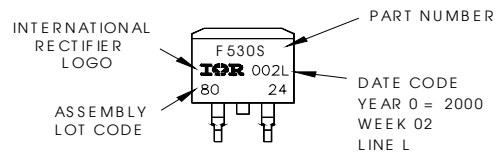

**OR**

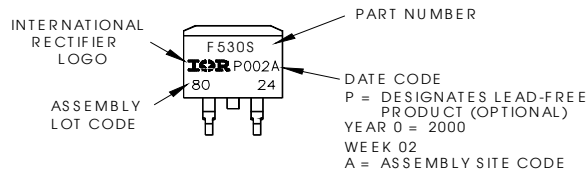



## TO-262 Package Outline

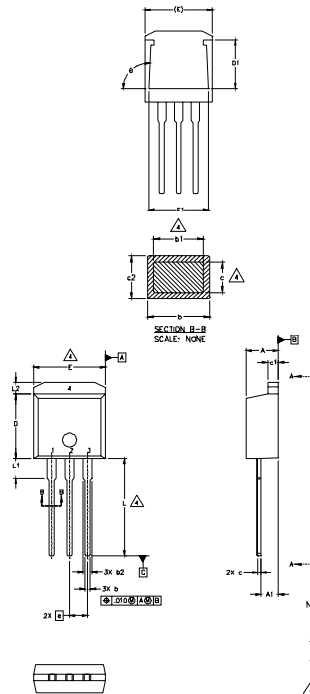

SYMBOL	DIMENSIONS				NOTES
	MILLIMETERS		INCHES		
	MIN.	MAX.	MIN.	MAX.	
A	4.06	4.83	.160	.190	
A1	2.03	2.92	.080	.115	
b	0.51	0.99	.020	.039	
b1	0.51	0.89	.020	.035	4
b2	1.14	1.40	.045	.055	
c	0.38	0.63	.015	.025	4
c1	1.14	1.40	.045	.055	
c2	0.43	.063	.017	.029	
D	8.51	9.65	.335	.380	3
D1	5.33		.210		
E	9.65	10.67	.380	.420	3
E1	6.22		.245		
e	2.54 BSC		.100 BSC		
L	13.46	14.09	.530	.555	
L1	3.56	3.71	.140	.146	
L2		1.65		.065	

**LEAD ASSIGNMENTS**

	IGBT
<b>HEXFET</b>	1- GATE
1.- GATE	2- COLLECTOR
2.- DRAIN	3- EMITTER
3.- SOURCE	
4.- DRAIN	

- NOTES:
1. DIMENSIONING AND TOLERANCING PER ASME Y14.5M-1994
  2. DIMENSIONS ARE SHOWN IN MILLIMETERS [INCHES]
  3. DIMENSION D & E DO NOT INCLUDE MOLD FLASH. MOLD FLASH SHALL NOT EXCEED 0.127 [0.005"] PER SIDE. THESE DIMENSIONS ARE MEASURED AT THE OUTMOST EXTREMES OF THE PLASTIC BODY.
  4. DIMENSION b1 AND c1 APPLY TO BASE METAL ONLY.
  5. CONTROLLING DIMENSION: INCH.

## TO-262 Part Marking Information

EXAMPLE: THIS IS AN IRL3103L  
 LOT CODE 1789  
 ASSEMBLED ON WW 19, 1997  
 IN THE ASSEMBLY LINE "C"  
 Note: "P" in assembly line  
 position indicates "Lead-Free"

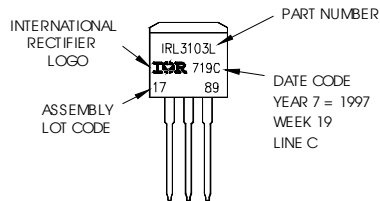

**OR**

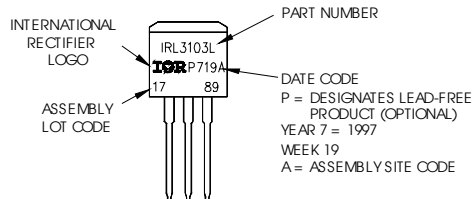

# IRF3708/S/LPbF

International  
**IR** Rectifier

## D<sup>2</sup>Pak Tape & Reel Information

Dimensions are shown in millimeters (inches)

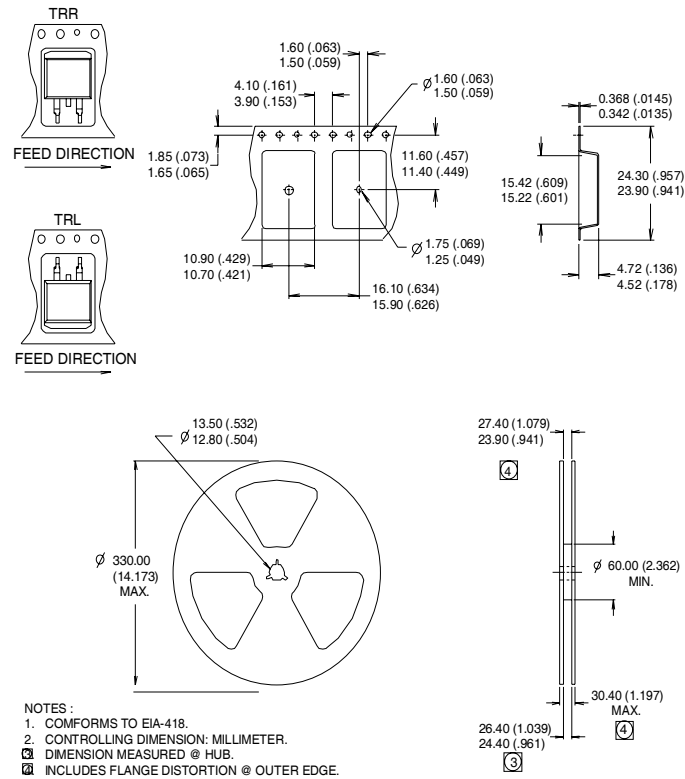

### Notes:

- ① Repetitive rating; pulse width limited by max. junction temperature.
- ② Starting  $T_J = 25^\circ\text{C}$ ,  $L = 0.7\text{ mH}$   
 $R_G = 25\Omega$ ,  $I_{AS} = 24.8\text{ A}$ .
- ③ Pulse width  $\leq 300\mu\text{s}$ ; duty cycle  $\leq 2\%$ .
- ④ This is only applied to TO-220AB package

Data and specifications subject to change without notice.

International  
**IR** Rectifier

IR WORLD HEADQUARTERS: 233 Kansas St., El Segundo, California 90245, USA Tel: (310) 252-7105  
TAC Fax: (310) 252-7903

Visit us at [www.irf.com](http://www.irf.com) for sales contact information.06/04

Note: For the most current drawings please refer to the IR website at:  
<http://www.irf.com/package/>

单击下面可查看定价，库存，交付和生命周期等信息

[>>Infineon Technologies\(英飞凌\)](#)