

MOSFET

650 V CoolSiC™ M1 SiC Trench Power Device

The 650 V CoolSiC™ is built over the solid silicon carbide technology developed in Infineon in more than 20 years. Leveraging the wide bandgap SiC material characteristics, the 650V CoolSiC™ MOSFET offers a unique combination of performance, reliability and ease of use. Suitable for high temperature and harsh operations, it enables the simplified and cost effective deployment of the highest system efficiency.

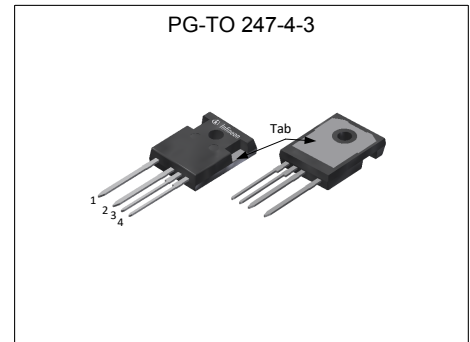

Features

- Optimized switching behavior at higher currents
- Commutation robust fast body diode with low Q_{rr}
- Superior gate oxide reliability
- Best thermal conductivity and behavior
- Lower $R_{DS(on)}$ and pulse current dependency on temperature
- Increased avalanche capability
- Compatible with standard drivers (recommended driving voltage: 18V)
- Kelvin source provides up to 4 times lower switching losses

Benefits

- Unique combination of high performance, high reliability and ease of use
- Ease of use and integration
- Suitable for topologies with continuous hard commutation
- Higher robustness and system reliability
- Efficiency improvement
- Reduced system size leading to higher power density

Potential applications

- SMPS
- UPS (uninterruptable power supplies)
- Solar PV inverters
- EV charging infrastructure
- Energy storage and battery formation
- Class D amplifiers

Product validation

Fully qualified according to JEDEC for Industrial Applications

Table 1 Key Performance Parameters

Parameter	Value	Unit
$V_{DS} @ T_J = 25\text{ °C}$	650	V
$R_{DS(on),typ}$	107	mΩ
$Q_{G,typ}$	15	nC
$I_{D,pulse}$	48	A
$Q_{oss} @ 400\text{ V}$	35	nC
$E_{oss} @ 400\text{ V}$	5.3	μJ

Type / Ordering Code	Package	Marking	Related Links
IMZA65R107M1H	PG-TO 247-4-3	65R107M1	see Appendix A

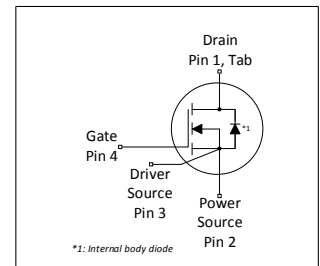

Table of Contents

Description	1
Maximum ratings	3
Thermal characteristics	4
Electrical characteristics	5
Electrical characteristics diagrams	7
Test Circuits	12
Package Outlines	13
Appendix A	14
Revision History	15
Trademarks	15
Disclaimer	15

1 Maximum ratings

at $T_J = 25\text{ °C}$, unless otherwise specified

Table 2 Maximum ratings

Parameter	Symbol	Values			Unit	Note / Test Condition
		Min.	Typ.	Max.		
Continuous drain current ¹⁾	I_D	-	-	20 13	A	$T_C = 25\text{ °C}$ $T_C = 100\text{ °C}$
Pulsed drain current ²⁾	$I_{D,pulse}$	-	-	48	A	$T_C = 25\text{ °C}$
Avalanche energy, single pulse	E_{AS}	-	-	76	mJ	$I_D = 2.8\text{ A}$, $V_{DD} = 50\text{ V}$, $L = 19.4\text{ mH}$; see table 10
Avalanche energy, repetitive	E_{AR}	-	-	0.38	mJ	$I_D = 2.8\text{ A}$, $V_{DD} = 50\text{ V}$; see table 10
Avalanche current, single pulse	I_{AS}	-	-	2.8	A	-
MOSFET dv/dt ruggedness	dv/dt	-	-	200	V/ns	$V_{DS} = 0...400\text{ V}$
Gate source voltage (recommended driving voltage)	V_{GS}	0	-	18	V	AC ($f > 1\text{ Hz}$)
Gate source voltage (dynamic)	V_{GS}	-5	-	23	V	$t_{pulse,negative} \leq 15\text{ ns}$
Power dissipation	P_{tot}	-	-	75	W	$T_C = 25\text{ °C}$
Storage temperature	T_{stg}	-55	-	150	°C	-
Operating junction temperature	T_J	-55	-	150	°C	-
Mounting torque	-	-	-	60	Ncm	M3 and M3.5 screws
Continuous diode forward current ¹⁾	I_S	-	-	20	A	$T_C = 25\text{ °C}$
Diode pulse current ²⁾	$I_{S,pulse}$	-	-	48	A	$T_C = 25\text{ °C}$
Insulation withstand voltage	V_{ISO}	-	-	n.a.	V	V_{rms} , $T_C = 25\text{ °C}$, $t = 1\text{ min}$

¹⁾ Limited by $T_{J,max}$

²⁾ Pulse width t_p limited by $T_{J,max}$

2 Thermal characteristics

Table 3 Thermal characteristics

Parameter	Symbol	Values			Unit	Note / Test Condition
		Min.	Typ.	Max.		
Thermal resistance, junction - case	R_{thJC}	-	-	1.6	°C/W	-
Thermal resistance, junction - ambient	R_{thJA}	-	-	62	°C/W	leaded
Thermal resistance, junction - ambient for SMD version	R_{thJA}	-	-	-	°C/W	n.a.
Soldering temperature, wavesoldering only allowed at leads	T_{sold}	-	-	260	°C	1.6mm (0.063 in.) from case for 10s

3 Electrical characteristics

at $T_J = 25\text{ °C}$, unless otherwise specified

Table 4 Static characteristics

Parameter	Symbol	Values			Unit	Note / Test Condition
		Min.	Typ.	Max.		
Drain-source breakdown voltage	$V_{(BR)DSS}$	650	-	-	V	$V_{GS} = 0\text{ V}$, $I_D = 0.3\text{ mA}$
Gate threshold voltage ¹⁾	$V_{(GS)th}$	3.5	4.5	5.7	V	$V_{DS} = V_{GS}$, $I_D = 3\text{ mA}$
Zero gate voltage drain current	I_{DSS}	-	1 2	150 -	μA	$V_{DS} = 650\text{ V}$, $V_{GS} = 0\text{ V}$, $T_J = 25\text{ °C}$ $V_{DS} = 650\text{ V}$, $V_{GS} = 0\text{ V}$, $T_J = 150\text{ °C}$
Gate-source leakage current	I_{GSS}	-	-	100	nA	$V_{GS} = 20\text{ V}$, $V_{DS} = 0\text{ V}$
Drain-source on-state resistance	$R_{DS(on)}$	-	0.107 0.139	0.142 -	Ω	$V_{GS} = 18\text{ V}$, $I_D = 8.9\text{ A}$, $T_J = 25\text{ °C}$ $V_{GS} = 18\text{ V}$, $I_D = 8.9\text{ A}$, $T_J = 150\text{ °C}$
Gate resistance	R_G	-	12.0	-	Ω	$f = 1\text{ MHz}$, open drain

Table 5 Dynamic characteristics

Parameter	Symbol	Values			Unit	Note / Test Condition
		Min.	Typ.	Max.		
Input capacitance	C_{iss}	-	496	-	pF	$V_{GS} = 0\text{ V}$, $V_{DS} = 400\text{ V}$, $f = 250\text{ kHz}$
Reverse capacitance	C_{riss}	-	7	-	pF	$V_{GS} = 0\text{ V}$, $V_{DS} = 400\text{ V}$, $f = 250\text{ kHz}$
Output capacitance ²⁾	C_{oss}	-	58	75	pF	$V_{GS} = 0\text{ V}$, $V_{DS} = 400\text{ V}$, $f = 250\text{ kHz}$
Output charge ²⁾	Q_{oss}	-	35	46	nC	calculation based on C_{oss}
Effective output capacitance, energy related ³⁾	$C_{o(er)}$	-	66	-	pF	$V_{GS} = 0\text{ V}$, $V_{DS} = 0...400\text{ V}$
Effective output capacitance, time related ⁴⁾	$C_{o(tr)}$	-	87	-	pF	$I_D = \text{constant}$, $V_{GS} = 0\text{ V}$, $V_{DS} = 0...400\text{ V}$
Turn-on delay time	$t_{d(on)}$	-	6.6	-	ns	$V_{DD} = 400\text{ V}$, $V_{GS} = 18\text{ V}$, $I_D = 8.9\text{ A}$, $R_G = 1.8\text{ }\Omega$; see table 9
Rise time	t_r	-	7.4	-	ns	$V_{DD} = 400\text{ V}$, $V_{GS} = 18\text{ V}$, $I_D = 8.9\text{ A}$, $R_G = 1.8\text{ }\Omega$; see table 9
Turn-off delay time	$t_{d(off)}$	-	12.2	-	ns	$V_{DD} = 400\text{ V}$, $V_{GS} = 18\text{ V}$, $I_D = 8.9\text{ A}$, $R_G = 1.8\text{ }\Omega$; see table 9
Fall time	t_f	-	6.4	-	ns	$V_{DD} = 400\text{ V}$, $V_{GS} = 18\text{ V}$, $I_D = 8.9\text{ A}$, $R_G = 1.8\text{ }\Omega$; see table 9

¹⁾ Tested after 1 ms pulse at $V_{GS} = +20\text{ V}$

²⁾ Maximum specification is defined by calculated six sigma upper confidence bound

³⁾ $C_{o(er)}$ is a fixed capacitance that gives the same stored energy as C_{oss} while V_{DS} is rising from 0 to 400 V

⁴⁾ $C_{o(tr)}$ is a fixed capacitance that gives the same charging time as C_{oss} while V_{DS} is rising from 0 to 400 V

Table 6 Gate charge characteristics

Parameter	Symbol	Values			Unit	Note / Test Condition
		Min.	Typ.	Max.		
Gate to source charge	Q_{gs}	-	4	-	nC	$V_{DD} = 400\text{ V}$, $I_D = 8.9\text{ A}$, $V_{GS} = 0\text{ to }18\text{ V}$
Gate to drain charge	Q_{gd}	-	4	-	nC	$V_{DD} = 400\text{ V}$, $I_D = 8.9\text{ A}$, $V_{GS} = 0\text{ to }18\text{ V}$
Gate charge total	Q_g	-	15	-	nC	$V_{DD} = 400\text{ V}$, $I_D = 8.9\text{ A}$, $V_{GS} = 0\text{ to }18\text{ V}$

Table 7 Reverse diode characteristics

Parameter	Symbol	Values			Unit	Note / Test Condition
		Min.	Typ.	Max.		
Diode forward voltage	V_{SD}	-	4.0	-	V	$V_{GS} = 0\text{ V}$, $I_F = 8.9\text{ A}$, $T_J = 25\text{ °C}$
Reverse recovery time	t_{rr}	-	55	-	ns	$V_R = 400\text{ V}$, $I_F = 8.9\text{ A}$, $di_F/dt = 1000\text{ A}/\mu\text{s}$; see table 8
Reverse recovery charge	Q_{rr}	-	76	-	nC	$V_R = 400\text{ V}$, $I_F = 8.9\text{ A}$, $di_F/dt = 1000\text{ A}/\mu\text{s}$; see table 8
Peak reverse recovery current	I_{rrm}	-	6.8	-	A	$V_R = 400\text{ V}$, $I_F = 8.9\text{ A}$, $di_F/dt = 1000\text{ A}/\mu\text{s}$; see table 8

4 Electrical characteristics diagrams

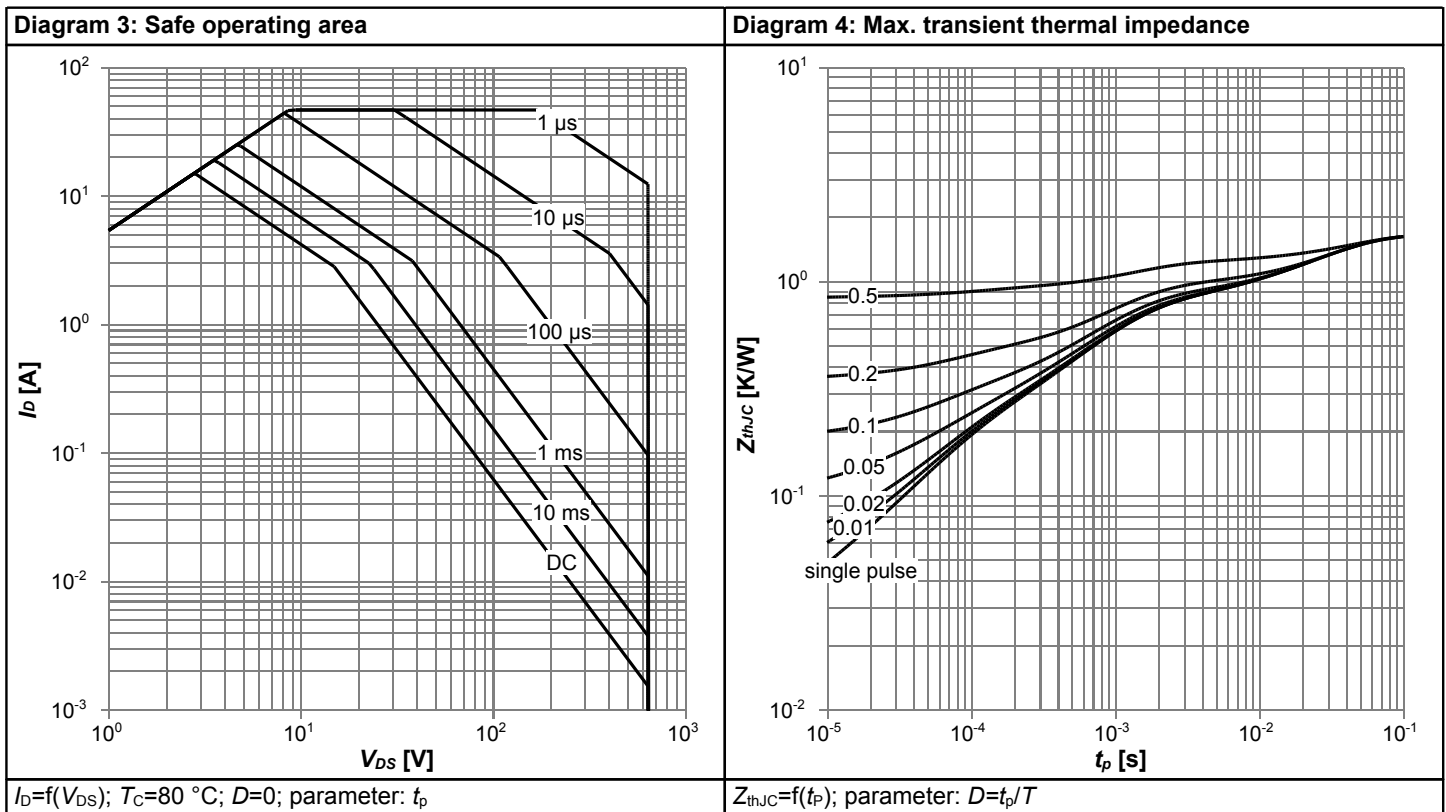
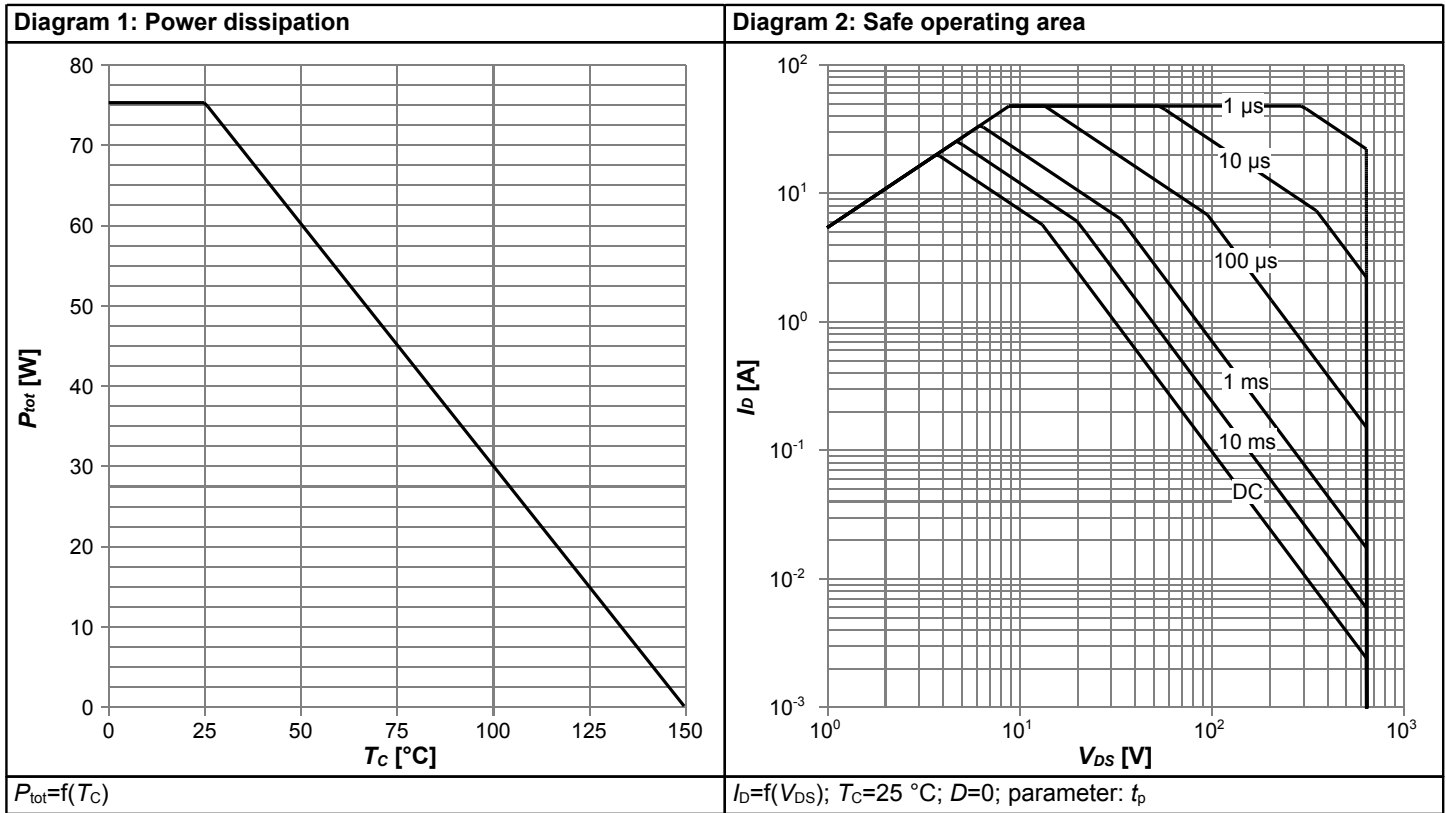
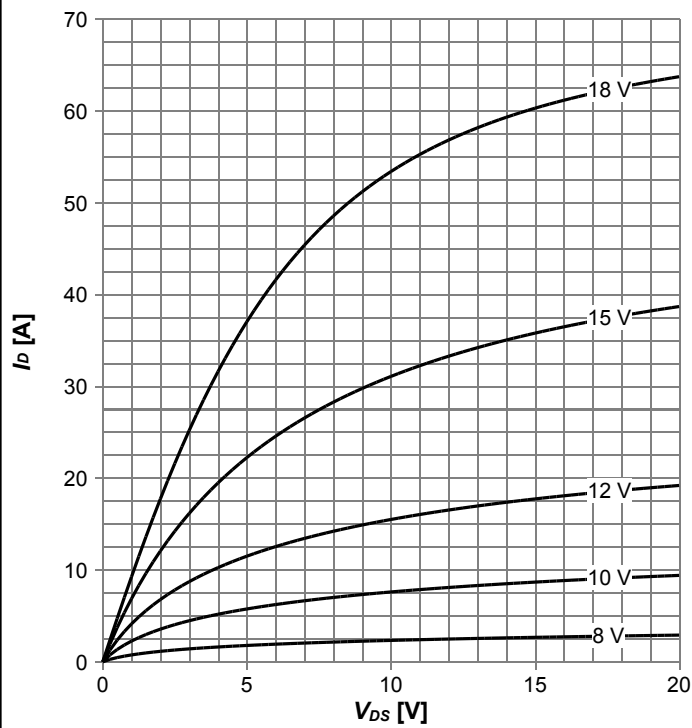
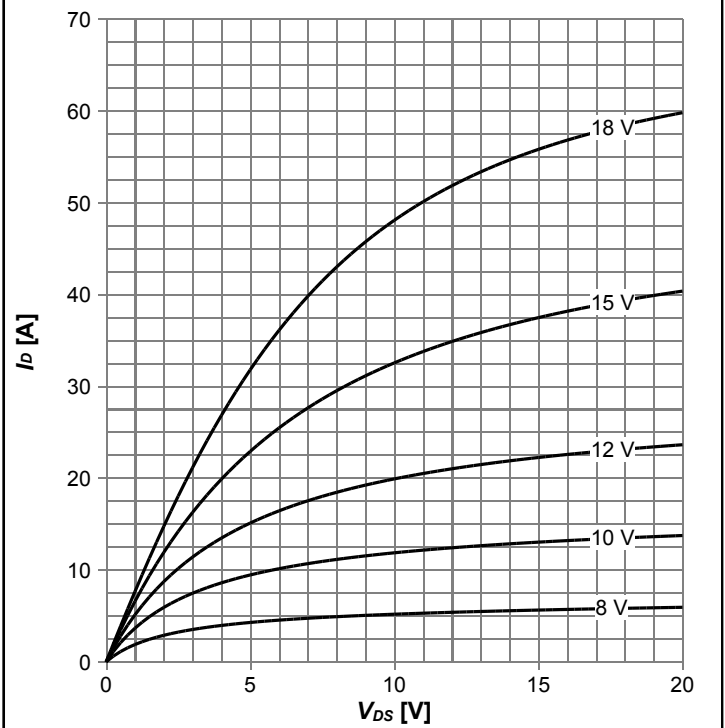

Diagram 5: Typ. output characteristics



$I_D=f(V_{DS})$; $T_j=25\text{ °C}$; parameter: V_{GS}

Diagram 6: Typ. output characteristics



$I_D=f(V_{DS})$; $T_j=125\text{ °C}$; parameter: V_{GS}

Diagram 7: Typ. drain-source on-state resistance

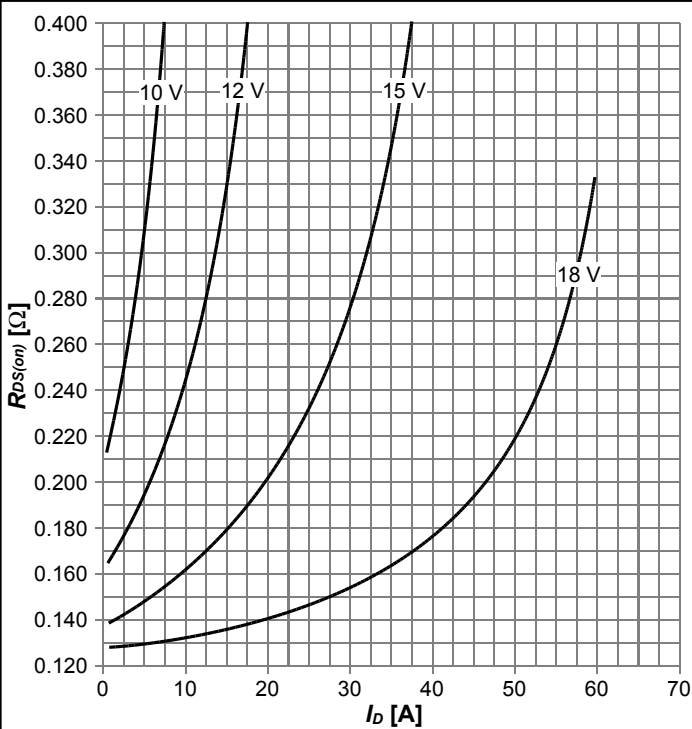

$R_{DS(on)}=f(I_D)$; $T_j=125\text{ °C}$; parameter: V_{GS}

Diagram 8: Drain-source on-state resistance

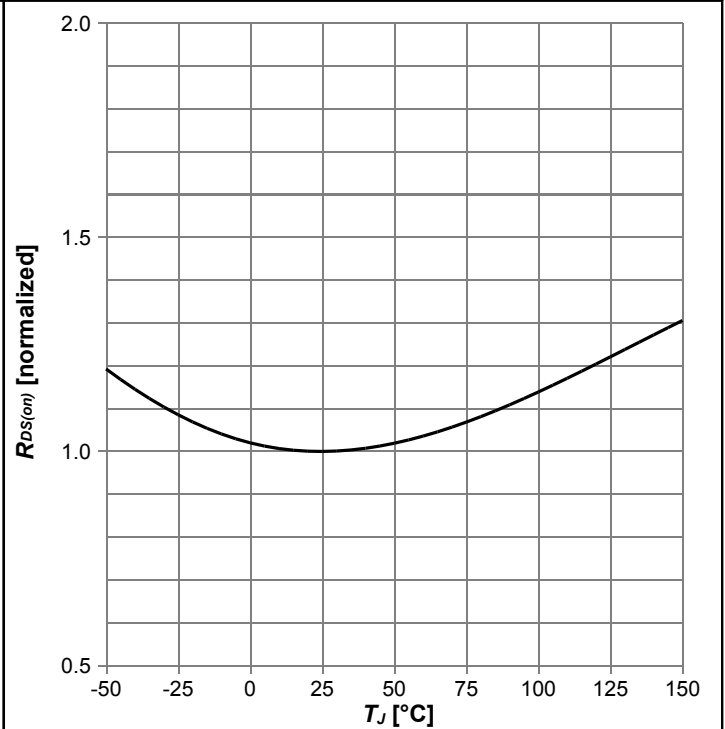

$R_{DS(on)}=f(T_j)$; $I_D=8.9\text{ A}$; $V_{GS}=18\text{ V}$

Diagram 9: Typ. transfer characteristics

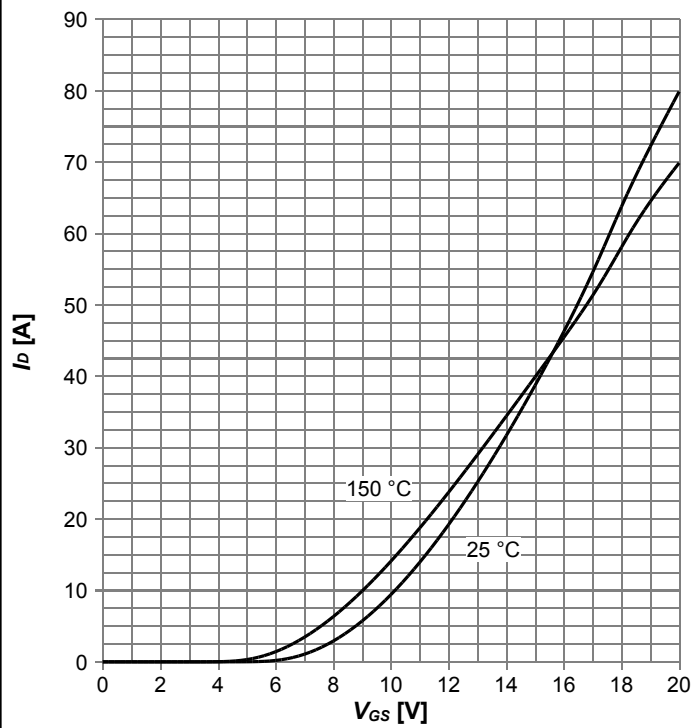

$I_D=f(V_{GS})$; $V_{DS}=20V$; parameter: T_j

Diagram 10: Typ. gate charge

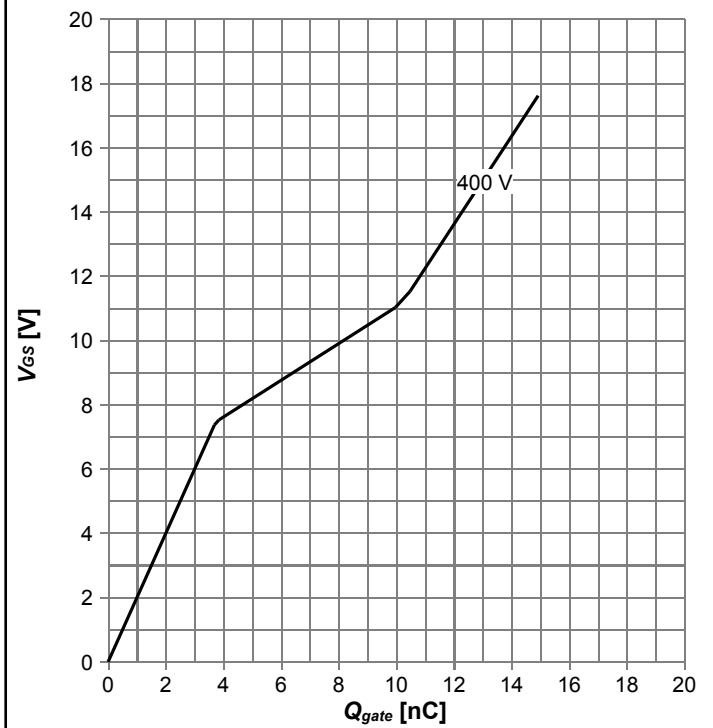

$V_{GS}=f(Q_{gate})$; $I_D=8.9$ A pulsed; parameter: V_{DD}

Diagram 11: Forward characteristics of reverse diode

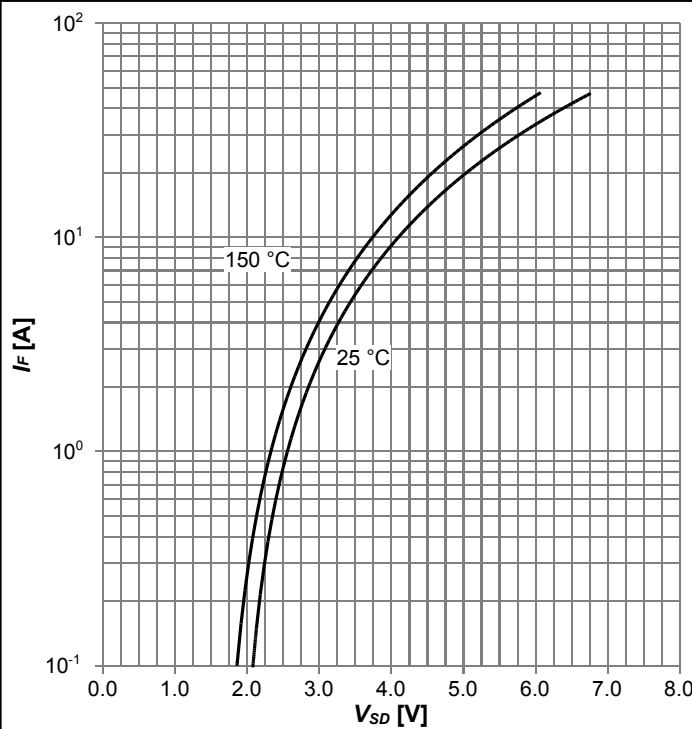

$I_F=f(V_{SD})$; parameter: T_j

Diagram 12: Forward characteristics of reverse diode

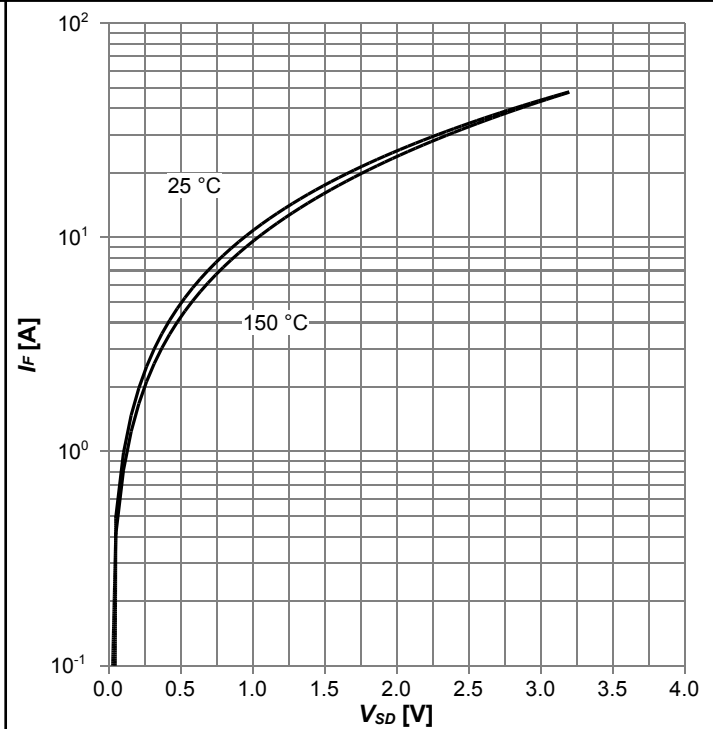

$I_F=f(V_{SD})$; $V_{GS}=18$ V; parameter: T_j

Diagram 13: Avalanche energy

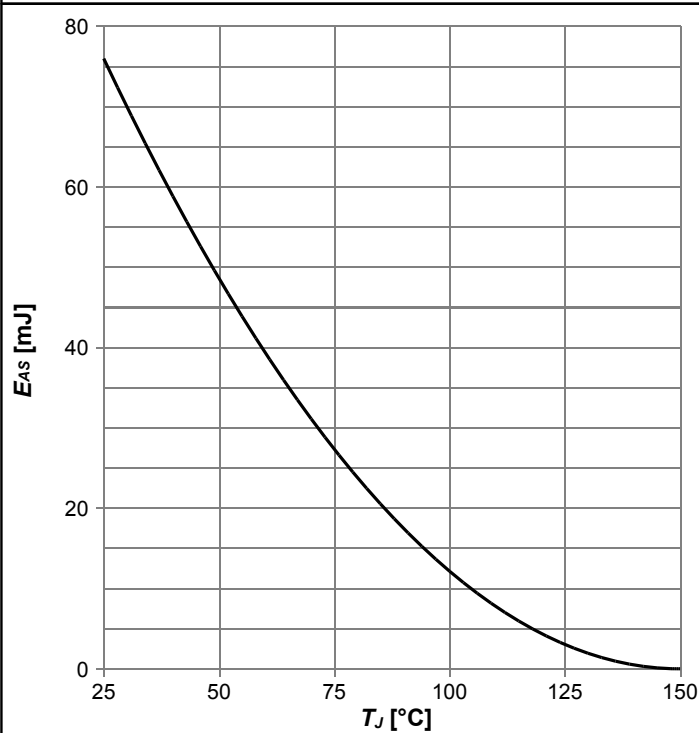

$E_{AS}=f(T_J)$; $I_D=2.8$ A; $V_{DD}=50$ V

Diagram 14: Drain-source breakdown voltage

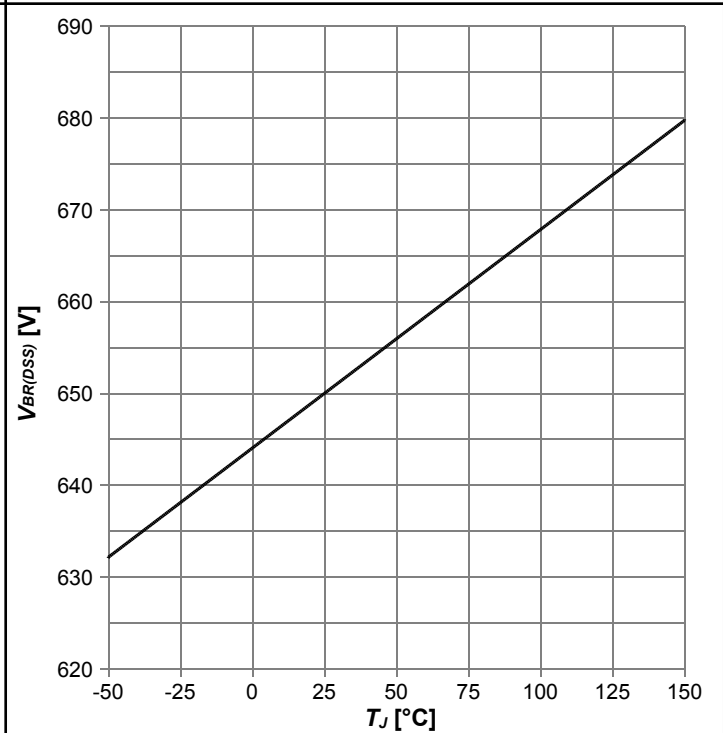

$V_{BR(DSS)}=f(T_J)$; $I_D=0.3$ mA

Diagram 15: Typ. capacitances

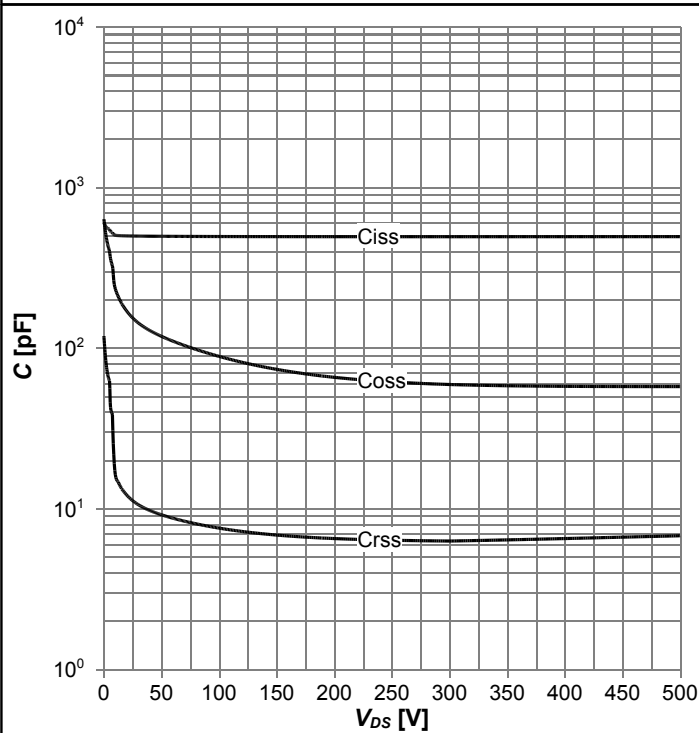

$C=f(V_{DS})$; $V_{GS}=0$ V; $f=250$ kHz

Diagram 16: Typ. Coss stored energy

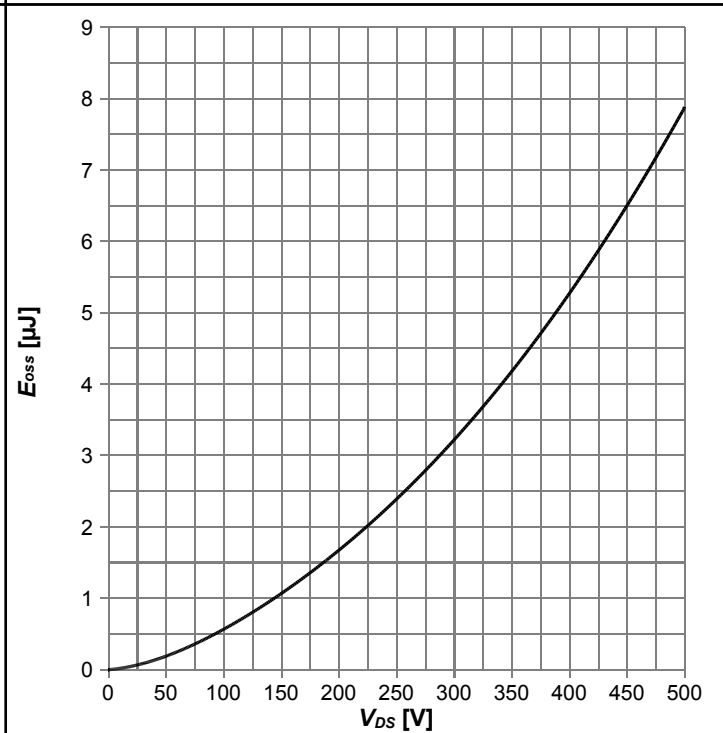

$E_{oss}=f(V_{DS})$

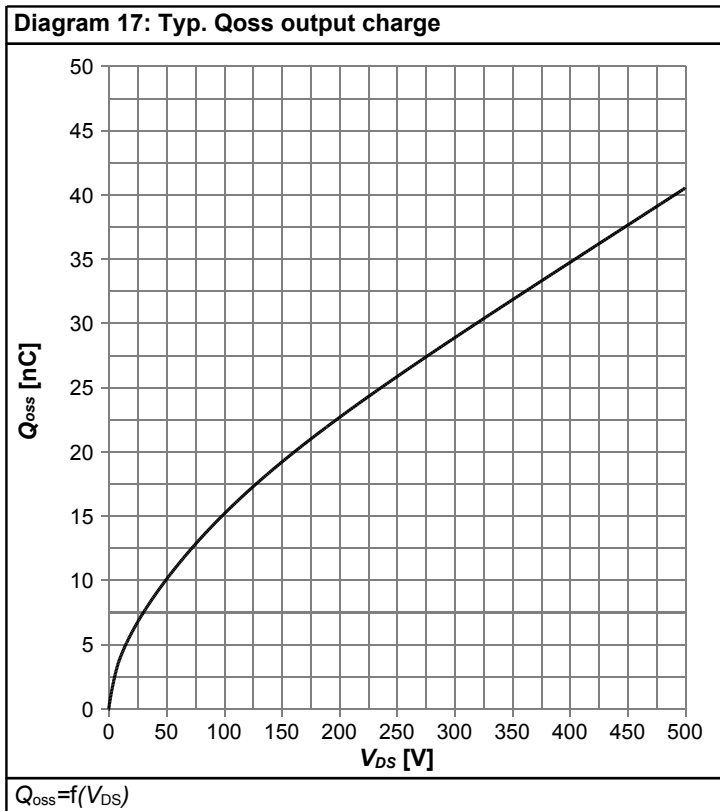

5 Test Circuits

Table 8 Diode characteristics

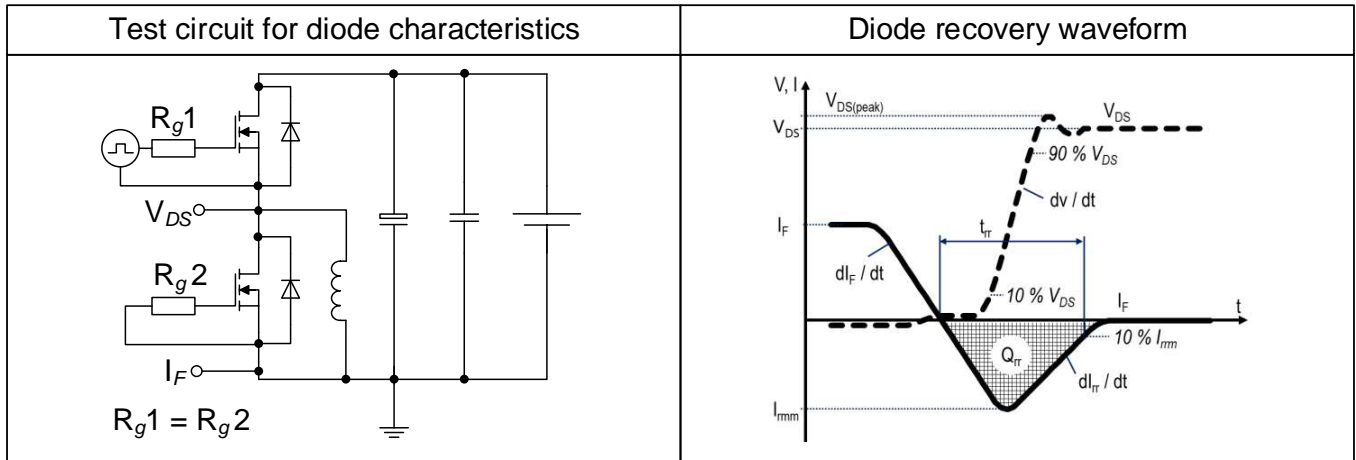

Table 9 Switching times (ss)

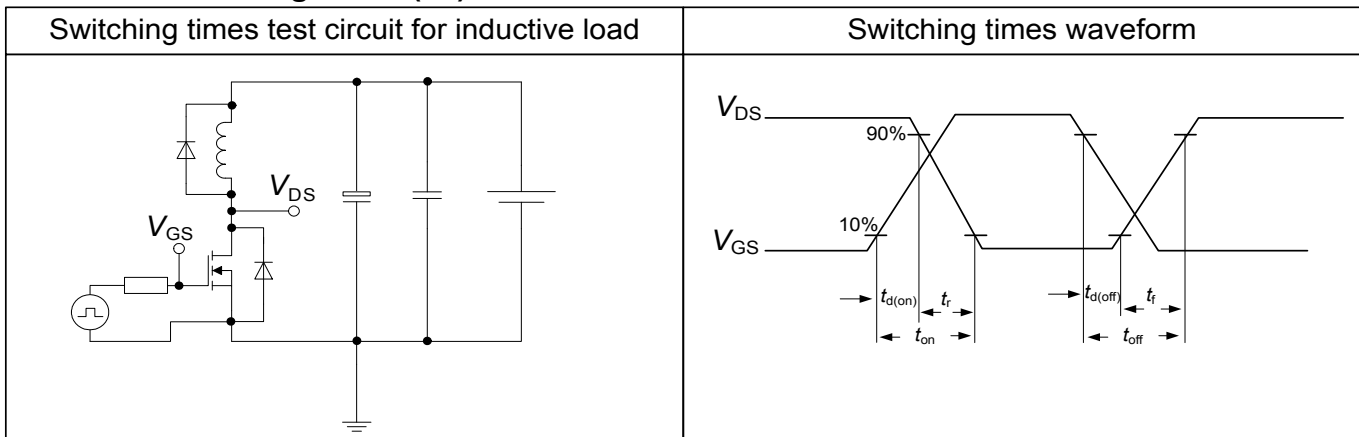
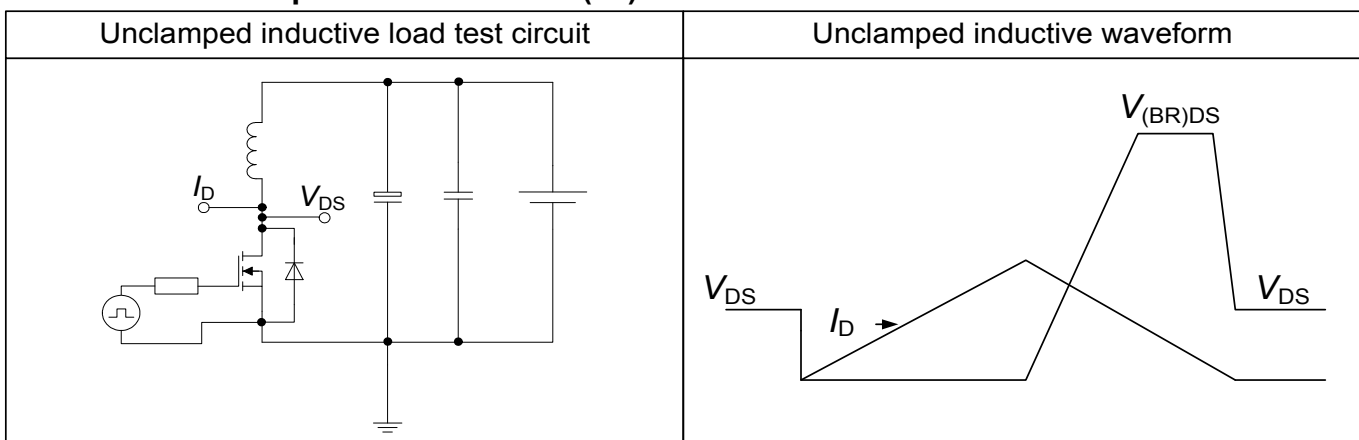
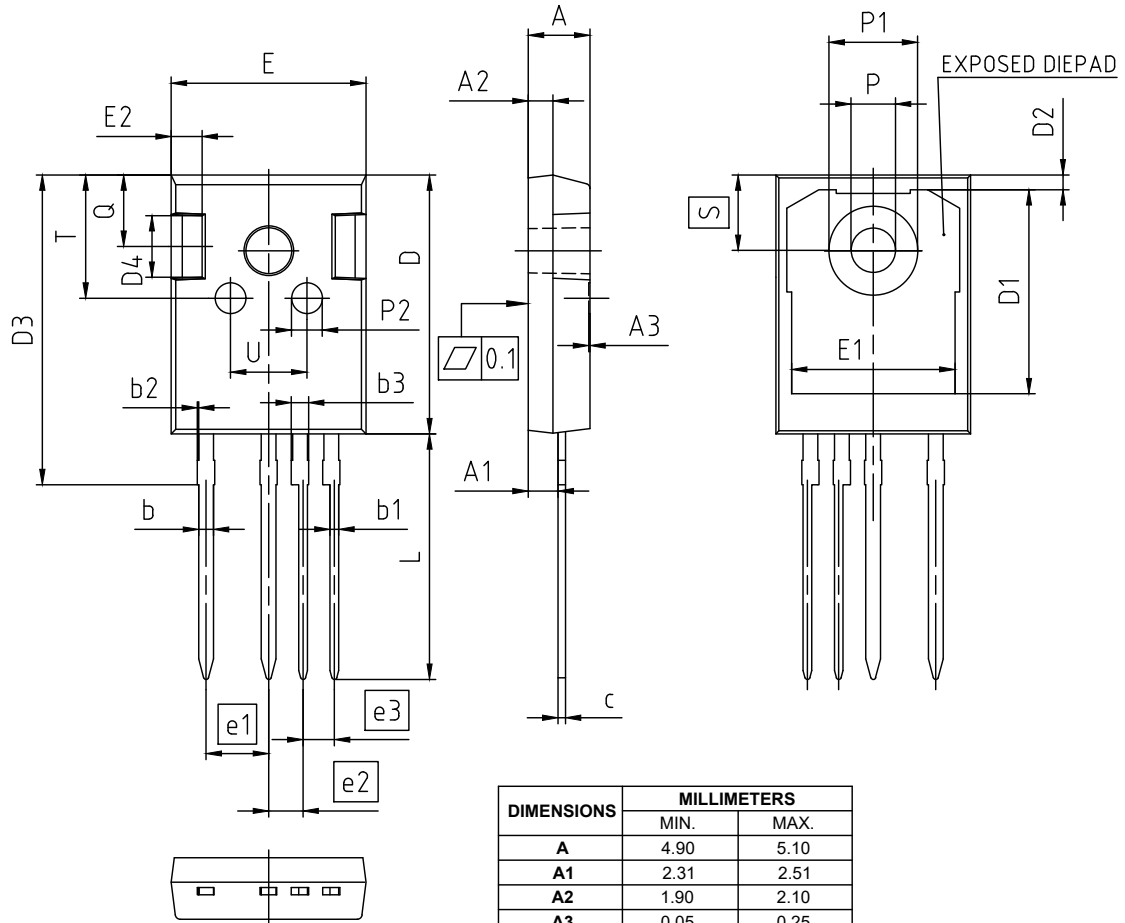

Table 10 Unclamped inductive load (ss)



6 Package Outlines



NOTES:
ALL DIMENSIONS DO NOT INCLUDE MOLD FLASH OR PROTRUSIONS.

DIMENSIONS	MILLIMETERS	
	MIN.	MAX.
A	4.90	5.10
A1	2.31	2.51
A2	1.90	2.10
A3	0.05	0.25
b	1.10	1.30
b1	0.65	0.79
b2	-	0.20
b3	1.34	1.44
c	0.58	0.66
D	20.90	21.10
D1	16.25	16.85
D2	1.05	1.35
D3	24.97	25.27
D4	4.90	5.10
E	15.70	15.90
E1	13.10	13.50
E2	2.40	2.60
e1	5.08	
e2	2.79	
e3	2.54	
L	19.80	20.10
L1	-	4.30
øP	3.50	3.70
øP1	7.00	7.40
øP2	2.40	2.60
Q	5.60	6.00
S	6.15	
T	9.80	10.20
U	6.00	6.40

DOCUMENT NO. Z8B00184785
REVISION 03
SCALE 2:1 0 5 10mm
EUROPEAN PROJECTION
ISSUE DATE 21.08.2017

Figure 1 Outline PG-TO 247-4-3, dimensions in mm

7 Appendix A

Table 11 Related Links

- IFX CoolSiC M1 Webpage: www.infineon.com
- IFX CoolSiC M1 application note: www.infineon.com
- IFX CoolSiC M1 simulation model: www.infineon.com
- IFX Design tools: www.infineon.com

Revision History

IMZA65R107M1H

Revision: 2019-12-16, Rev. 2.0

Previous Revision

Revision	Date	Subjects (major changes since last revision)
2.0	2019-12-16	Release of final version

Trademarks

All referenced product or service names and trademarks are the property of their respective owners.

We Listen to Your Comments

Any information within this document that you feel is wrong, unclear or missing at all? Your feedback will help us to continuously improve the quality of this document. Please send your proposal (including a reference to this document) to:

erratum@infineon.com

Published by

Infineon Technologies AG
81726 München, Germany
© 2019 Infineon Technologies AG
All Rights Reserved.

Legal Disclaimer

The information given in this document shall in no event be regarded as a guarantee of conditions or characteristics ("Beschaffheitsgarantie").

With respect to any examples, hints or any typical values stated herein and/or any information regarding the application of the product, Infineon Technologies hereby disclaims any and all warranties and liabilities of any kind, including without limitation warranties of non-infringement of intellectual property rights of any third party.

In addition, any information given in this document is subject to customer's compliance with its obligations stated in this document and any applicable legal requirements, norms and standards concerning customer's products and any use of the product of Infineon Technologies in customer's applications.

The data contained in this document is exclusively intended for technically trained staff. It is the responsibility of customer's technical departments to evaluate the suitability of the product for the intended application and the completeness of the product information given in this document with respect to such application.

Information

For further information on technology, delivery terms and conditions and prices please contact your nearest Infineon Technologies Office (www.infineon.com).

Warnings

Due to technical requirements, components may contain dangerous substances. For information on the types in question, please contact the nearest Infineon Technologies Office.

The Infineon Technologies component described in this Data Sheet may be used in life-support devices or systems and/or automotive, aviation and aerospace applications or systems only with the express written approval of Infineon Technologies, if a failure of such components can reasonably be expected to cause the failure of that life-support, automotive, aviation and aerospace device or system or to affect the safety or effectiveness of that device or system. Life support devices or systems are intended to be implanted in the human body or to support and/or maintain and sustain and/or protect human life. If they fail, it is reasonable to assume that the health of the user or other persons may be endangered.

单击下面可查看定价，库存，交付和生命周期等信息

[>>Infineon\(英飞凌\)](#)