

Key data

3x 306A rms at 400V rms, forced air (fan not implemented)

General information

Stacks for various inverter application. IGBT's, heat sinks, capacitors, drivers and sensors included.

Please read carefully the complete document and maintain the proper design environment!

Topology	B6I	
Application / Modulation	Inverter / Sine	
Load type	resistive, inductive	
Cooling	forced air (fan not implemented)	
Implemented sensors	current, voltage, temperature	
Semicond. (Unit 1)	none	
DC Link	2.4mF	
Semicond. (Unit 2)	IGBT	6x FF200R12KE4
Driver signals IGBT	electrical CMOS 0 .. 15V	
Standards	EN50178, UL94	
Sales - name	6PS04012E4DG36022	
Internal ID	36022	
Mechanical drawing number	36022_MB	
Electrical drawing number	2PS-CD-V	

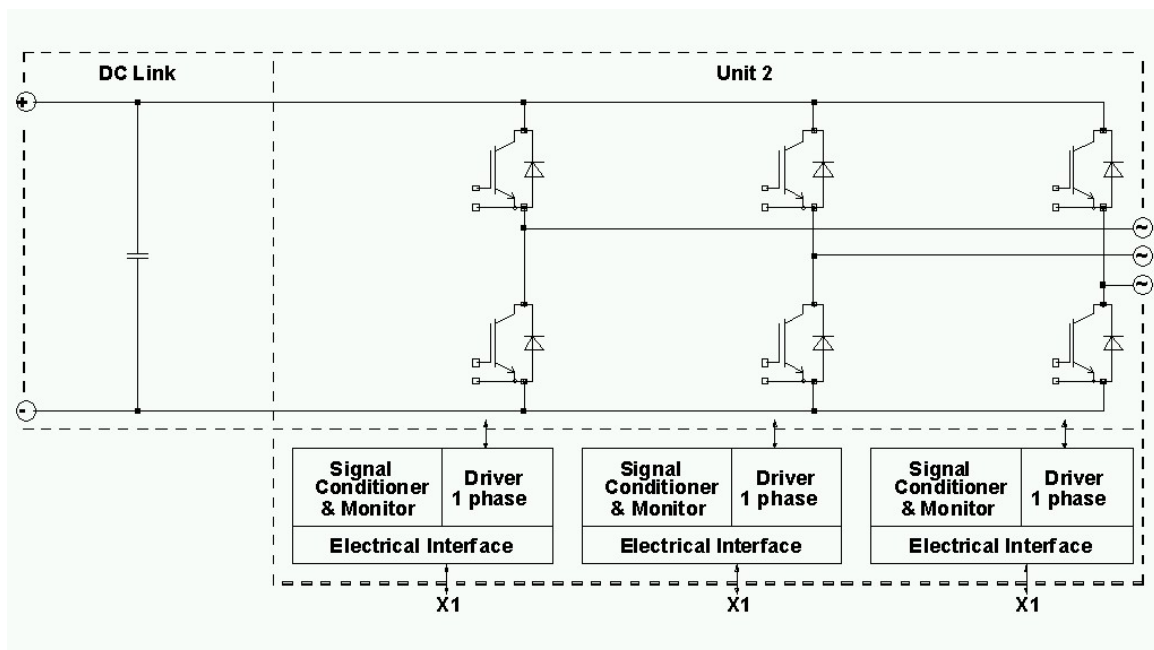
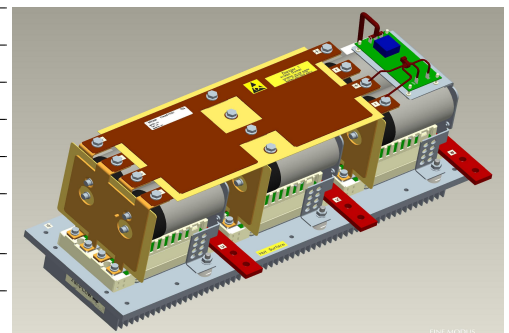

prepared by: OW	date of publication: 2012-10-17
approved by: AR	revision: 2.1

Technical Information

PrimeSTACK™

6PS04012E4DG36022



Preliminary data

Notes

Overvoltage sensor is located only in the middle phase.

Electrical data

DC Link			min	typ	max	units
Voltage		V_{DC}		650	850	V
Overvoltage shutdown	within 5000 μ s			850		V

Unit 2 AC			min	typ	max	units
Voltage	depending on controller	V_{Unit2}		400		V_{RMS}
Continuous current	$V_{Unit2} = 400V_{RMS}$, $V_{DC} = 650V$, $T_{inlet} = 40^{\circ}C$, $T_J \leq 125^{\circ}C$, $f_{Unit2} = 50Hz$, $f_{sw2} = 5000Hz$, $\cos(\phi) = 0,85$	I_{Unit2}			306	A_{RMS}
Continuous current overload cap.	$T_{inlet} = 40^{\circ}C$, for overload capability 150% for 60s			217		A_{RMS}
DC current	no rotating field, $T_{inlet} = 40^{\circ}C$	$I_{Unit2 DC}$			159,0	A_{av}
Overcurrent shutdown	within 15 μ s			640		A_{peak}
Switching frequency		f_{sw2}			20000	Hz
Power losses	$V_{Unit2} = 400V$, $V_{DC} = 650V$, $T_{inlet} = 40^{\circ}C$, $T_J \leq 125^{\circ}C$, $f_{Unit2} = 50Hz$, $f_{sw2} = 5000Hz$, $\cos(\phi) = 0,85$, $I_{Unit2} = 306A_{RMS}$	P_{loss2}		3030		W
Power factor		$\cos(\phi)_{Unit2}$	-1,00		1,00	

General data			min	typ	max	units
Power losses (PCB)		$P_{loss aux}$			40	W
EMC test	according to IEC61800-3 at named interfaces	power	V_{Burst}	2		kV
		control	V_{Burst}	1		kV
		aux (24V)	V_{Surge}	1		kV
Insulation management is designed for		V_{Line}		690		V_{RMS}
Insulation test voltage	according to EN50178, $f = 50Hz$, $t = 60s$	V_{isol}		2,5		kV_{RMS}

Important component data			min	typ	max	units
DC Link capacitor		C_{DC}		2,40		mF
		type		Foil		
Temperature range			-40		+85	$^{\circ}C$
Rated voltage	per device	U_R		1100		V_{DC}
Rated capacitance	per device	C_R		400		μF
Capacitance tolerance	per device	Tol	-10		+10	%
Maximum ripple current	per device, $T_{amb} = 55^{\circ}C$	I_{Rmax}			45	A_{RMS}
wiring system	series, parallel			1s, 6p		
Balance or discharge resistors	per DC Link unit	R_b		164,0		k Ω

prepared by: OW	date of publication: 2012-10-17
approved by: AR	revision: 2.1

Technical Information

PrimeSTACK™

6PS04012E4DG36022



Preliminary data

Controller interface data

			min	typ	max	units
Auxiliary voltage		V_{aux}	13	24	30	V_{av}
Auxiliary power requirement	$V_{aux} = 24V_{av}$	P_{aux}	120			W
Driver and interface board	see separate technical information		3 x DR240			
Driver core			EiceDRIVER 2ED300C17-S			
Digital input level	resistor to GND 10,0k Ω , capacitor to GND 1nF, high = on, min 15mA	V_{in}	0,0		15,0	V
Digital output level	open collector, low = ok, max 15mA	V_{out}	0,0		30,0	V
Analog current outputs Unit 2	load max 1mA; at 306A	$V_{ana\ out}$	4,80	4,90	5,00	V
Analog DC Link voltage output	load max 1mA; at 850V	$V_{DC\ out}$	8,33	8,50	8,67	V
Analog temperature output	load max 1mA; at $T_{NTC} = 75^{\circ}C$ correspond to $T_j = 125^{\circ}C$	$V_{T\ out}$		8,70		V
Overtemperature shutdown	at $T_{NTC} = 81^{\circ}C$ correspond to $T_j = 135^{\circ}C$	$V_{T\ out\ OT}$		10		V

Heat sink air cooled / Thermal data

			min	typ	max	units
Airflow	$T_{Air} = 20^{\circ}C$, $P_{Air} = 1013hPa$, dry- and dust free, measured on side of heat sink. according to DIN 41882	$\Delta V/\Delta t_{Air}$	1710			m ³ /h
Air pressure drop		Δp_{Air}		135		Pa
Cooling air inlet temperature	heat sink temperature < -25 $^{\circ}C$	T_{inlet}	-40		60	$^{\circ}C$

prepared by: OW	date of publication: 2012-10-17
approved by: AR	revision: 2.1

Technical Information

PrimeSTACK™

6PS04012E4DG36022



Preliminary data

IGBT data unit 2

			min	typ	max	units
Type	assumed					
collector-emitter saturation voltage	$I_c = 200A; V_{ge} = 15V; T_{vj} = 150^\circ C$	$V_{CE\ sat}$		2,05		V
parameter for linear model	$T_{vj} = 25^\circ C$	V_{ce1}		0,944		V
parameter for linear model	$T_{vj} = 25^\circ C$	r_{ce1}		4,031		mΩ
parameter for linear model	$T_{vj} = 150^\circ C$	V_{ce2}		0,89		V
parameter for linear model	$T_{vj} = 150^\circ C$	r_{ce2}		5,799		mΩ
turn-on / turn-off energy loss per pulse	$T_{vj} = 25^\circ C$	E_1		10 / 17		mJ
turn-on / turn-off energy loss per pulse	$T_{vj} = 150^\circ C$	E_2		17 / 29		mJ
thermal resistance, junction to case	per IGBT	R_{thjc}		0,135		K/W
thermal resistance, case to heatsink	per IGBT	R_{thch}		0,034		K/W

Diode data unit 2

			min	typ	max	units
Type	assumed					
forward voltage	$I_F = 200A; V_{ge} = 0V; T_{vj} = 150^\circ C$	V_F		1,65		V
parameter for linear model	$T_{vj} = 25^\circ C$	V_{F1}		1,06		V
parameter for linear model	$T_{vj} = 25^\circ C$	r_{F1}		2,951		mΩ
parameter for linear model	$T_{vj} = 150^\circ C$	V_{F2}		0,833		V
parameter for linear model	$T_{vj} = 150^\circ C$	r_{F2}		4,084		mΩ
reverse recovery energy	$T_{vj} = 25^\circ C$	E_{rec1}		9		mJ
reverse recovery energy	$T_{vj} = 150^\circ C$	E_{rec2}		17,5		mJ
thermal resistance, junction to case	per Diode	R_{thjc}		0,2		K/W
thermal resistance, case to heatsink	per Diode	R_{thch}		0,05		K/W

Environmental conditions

			min	typ	max	units
Storage temperature		T_{stor}	-40		80	°C
Ambient temperature		T_{amb}	-25		55	°C
Operating temperature	see chapter Heat sink air cooled / Thermal data					
Cooling air velocity (PCB)		$V_{Air\ PCB}$	2,0			m/s
Air pressure	standard atmosphere	p_{Air}	900		1100	hPa
Humidity	no condensation	Rel. F	5		85	%
Installation height			0		1000	m
Vibration	according to IEC60721				5	m/s ²
Shock	according to IEC60721				40	m/s ²
Protection degree				IP00		
Pollution degree				2		
Torque at DC Terminals		M_{DC}	6,0		10,0	Nm
Torque at AC Terminals		M_{AC}	16,0		20,0	Nm
Dimensions	width × depth × height		645	276	298	mm
Weight with heat sink	approximation			35,0		kg

prepared by: OW	date of publication: 2012-10-17
approved by: AR	revision: 2.1



Preliminary data

fo - derating curve IGBT (motor), Diode (generator)
 cos(phi) = ± 0,85
 T_{cool medium} = 40°C

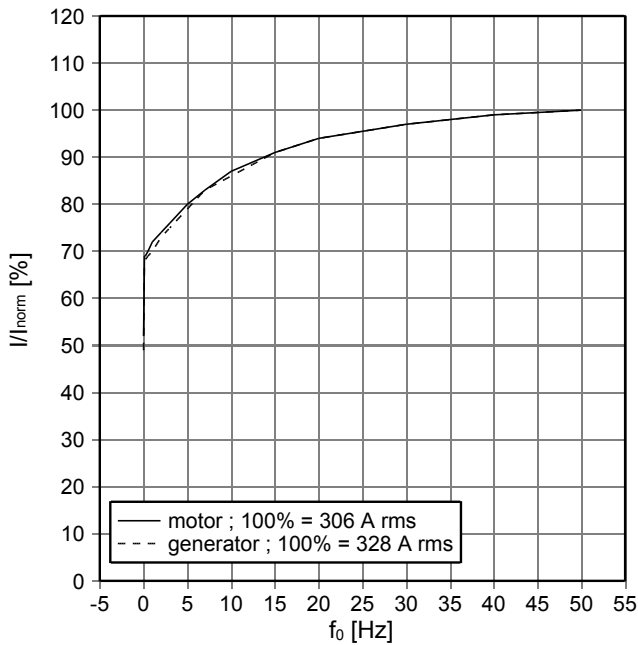

fsw - derating curve IGBT (motor), Diode (generator)
 cos(phi) = ± 0,85
 T_{cool medium} = 40°C

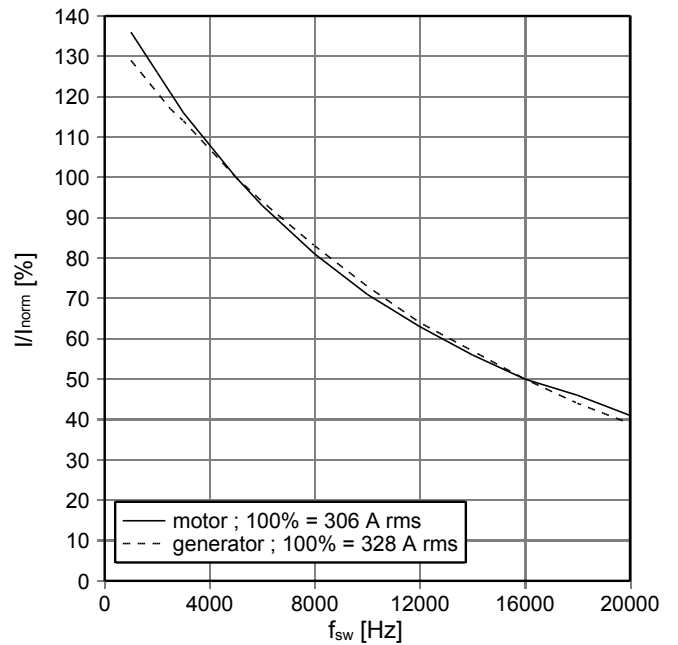

Transient thermal impedance per switch
 T_{cool medium} = 40°C

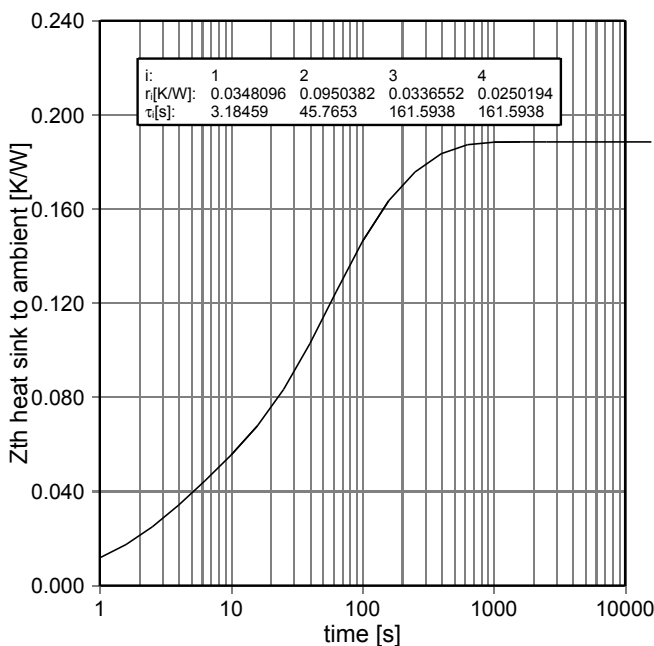

prepared by: OW	date of publication: 2012-10-17
approved by: AR	revision: 2.1

Mechanical drawing

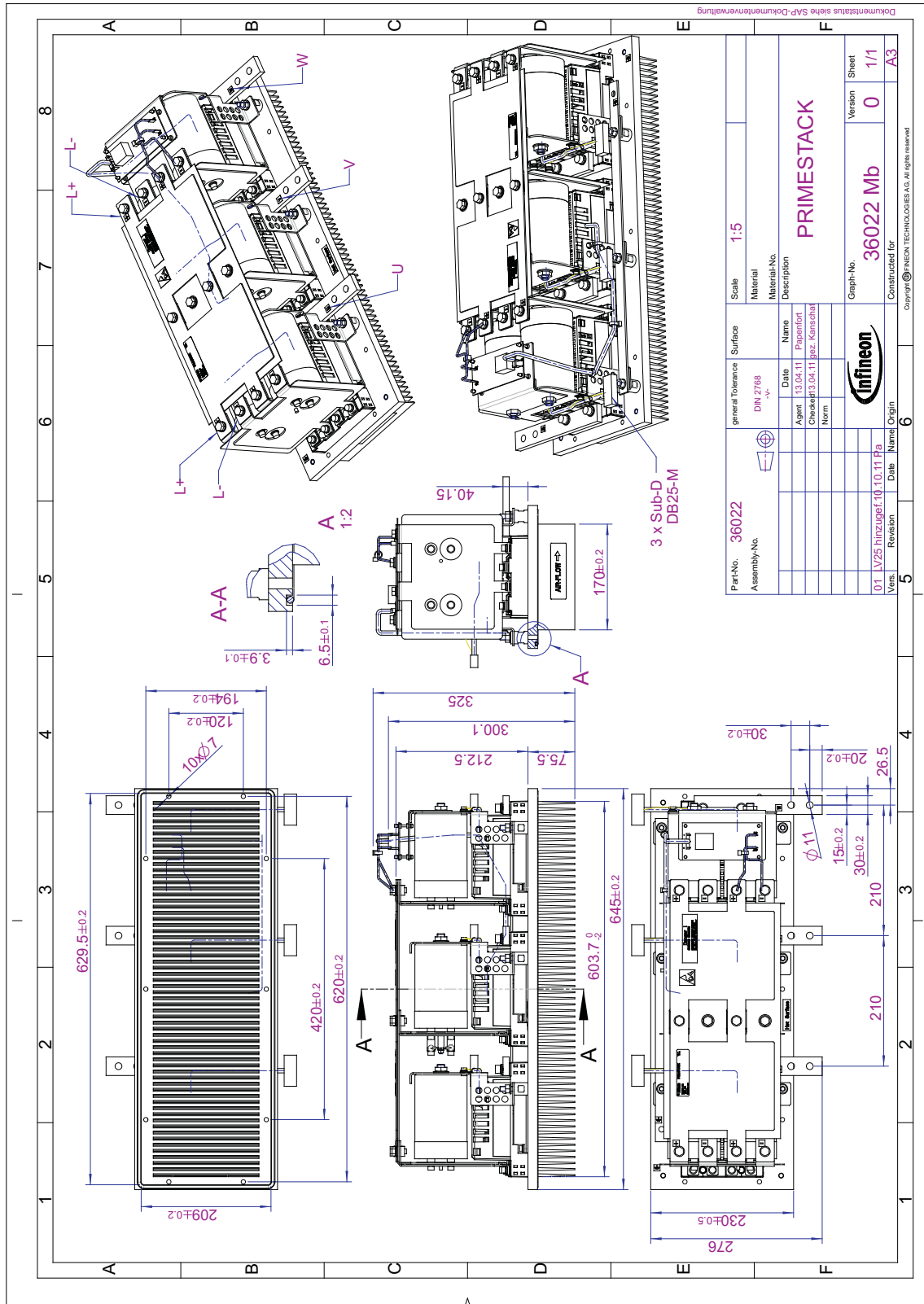

prepared by: OW	date of publication: 2012-10-17
approved by: AR	revision: 2.1

Circuit diagram

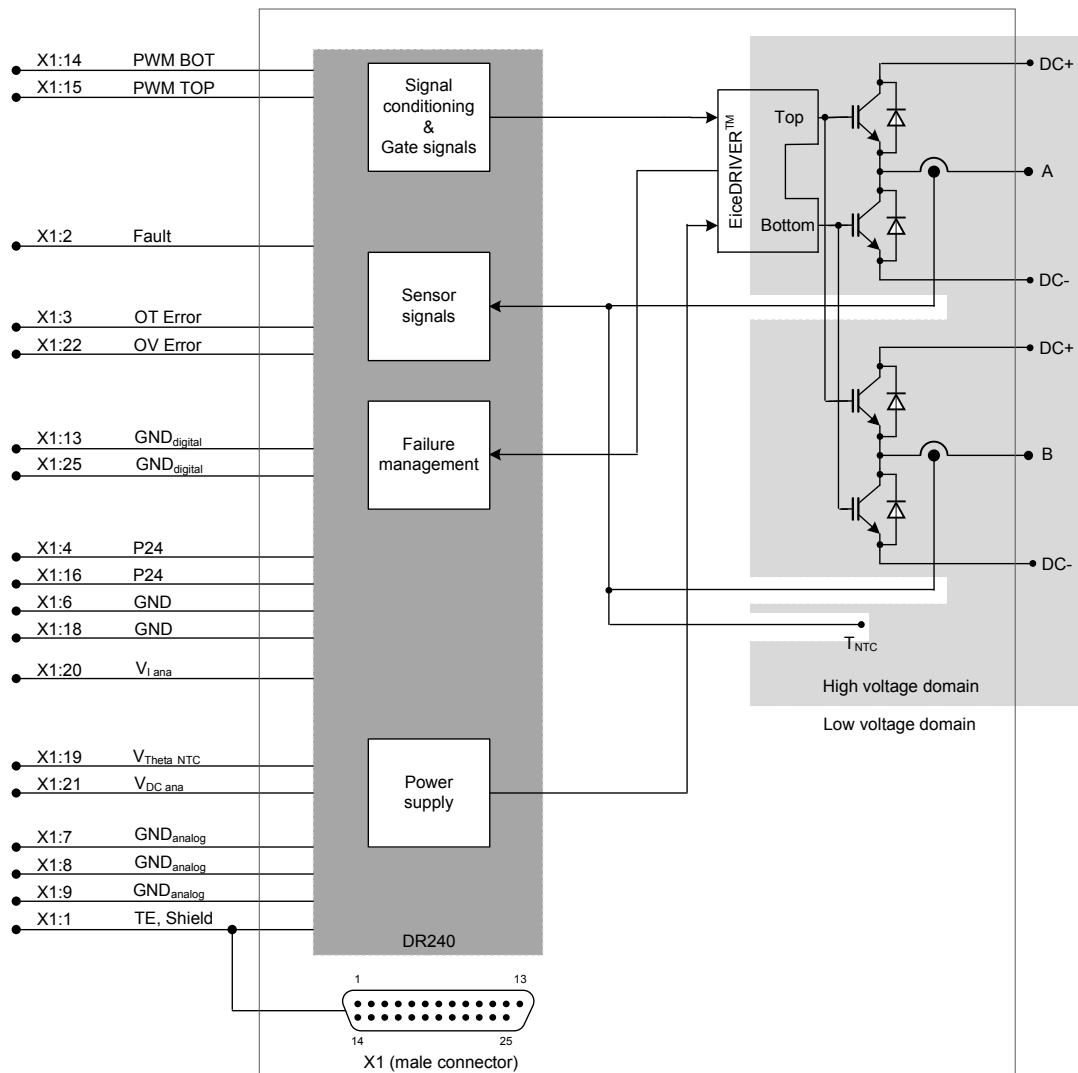

	Error outputs (open collector)		
	X1:2	X1:3	X1:22
Error driver core	X		
Over current	X		
Over temp. output stage	X	X	
Over temperature PCB		X	
Over voltage DC Link			
Under voltage power supply	X		X

X = high level with external pull up resistor

Voltage option only installed in the middle phase v

prepared by: OW	date of publication: 2012-10-17
approved by: AR	revision: 2.1



Preliminary data

Terms & Conditions of usage

The data contained in this product data sheet is exclusively intended for technically trained staff. You and your technical departments will have to evaluate the suitability of the product for the intended application and the completeness of the product data with respect to such application.

This product data sheet is describing the characteristics of this product for which a warranty is granted. Any such warranty is granted exclusively pursuant the terms and conditions of the supply agreement. There will be no guarantee of any kind for the product and its characteristics.

Should you require product information in excess of the data given in this product data sheet or which concerns the specific application of our product, please contact the sales office, which is responsible for you (see www.infineon.com, sales&contact). For those that are specifically interested we may provide application notes.

Due to technical requirements our product may contain dangerous substances. For information on the types in question please contact the sales office, which is responsible for you.

Should you intend to use the Product in aviation applications, in health or live endangering or life support applications, please notify. Please note, that for any such applications we urgently recommend

- to perform joint Risk and Quality Assessments;
- the conclusion of Quality Agreements;
- to establish joint measures of an ongoing product survey, and that we may make delivery depended on the realization of any such measures.

If and to the extent necessary, please forward equivalent notices to your customers.

Changes of this product data sheet are reserved.

Safety Instructions

Prior to installation and operation, all safety notices and warnings and all warning signs attached to the equipment have to be carefully read. Make sure that all warning signs remain in a legible condition and that missing or damaged signs are replaced. To installation and operation, all safety notices and warnings and all warning signs attached to the equipment have to be carefully read. Make sure that all warning signs remain in a legible condition and that missing or damaged signs are replaced.

prepared by: OW	date of publication: 2012-10-17
approved by: AR	revision: 2.1

单击下面可查看定价，库存，交付和生命周期等信息

[>>Infineon Technologies\(英飞凌\)](#)