

# IRF7907PbF

HEXFET® Power MOSFET

## Applications

- Dual SO-8 MOSFET for POL Converters in Notebook Computers, Servers, Graphics Cards, Game Consoles and Set-Top Box

## Benefits

- Very Low  $R_{DS(on)}$  at 4.5V  $V_{GS}$
- Low Gate Charge
- Fully Characterized Avalanche Voltage and Current
- 20V  $V_{GS}$  Max. Gate Rating
- Improved Body Diode Reverse Recovery
- 100% Tested for  $R_G$
- Lead-Free

$V_{DSS}$	$R_{DS(on)}$ max	$I_D$
30V	Q1 16.4m $\Omega$ @ $V_{GS} = 10V$	9.1A
	Q2 11.8m $\Omega$ @ $V_{GS} = 10V$	11A

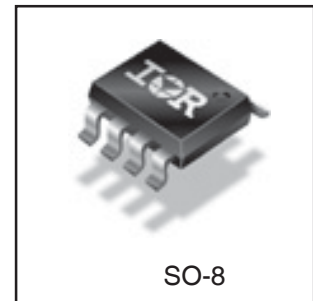
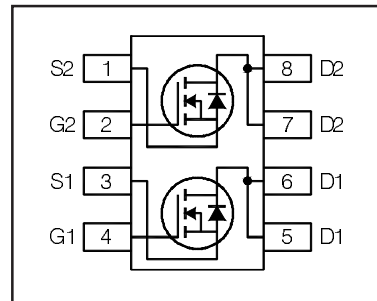

## Absolute Maximum Ratings

	Parameter	Q1 Max.	Q2 Max.	Units
$V_{DS}$	Drain-to-Source Voltage	30		V
$V_{GS}$	Gate-to-Source Voltage	$\pm 20$		
$I_D @ T_A = 25^\circ C$	Continuous Drain Current, $V_{GS} @ 10V$	9.1	11	A
$I_D @ T_A = 70^\circ C$	Continuous Drain Current, $V_{GS} @ 10V$	7.3	8.8	
$I_{DM}$	Pulsed Drain Current ①	76	85	
$P_D @ T_A = 25^\circ C$	Power Dissipation	2.0	2.0	W
$P_D @ T_A = 70^\circ C$	Power Dissipation	1.3	1.3	
	Linear Derating Factor	0.016	0.016	W/ $^\circ C$
$T_J$ $T_{STG}$	Operating Junction and Storage Temperature Range	-55 to + 150		$^\circ C$

## Thermal Resistance

	Parameter	Q1 Max.	Q2 Max.	Units
$R_{\theta JL}$	Junction-to-Drain Lead ⑤	42	42	$^\circ C/W$
$R_{\theta JA}$	Junction-to-Ambient ④⑤	62.5	62.5	

# IRF7907PbF

Static @ T<sub>J</sub> = 25°C (unless otherwise specified)

International  
IR Rectifier

	Parameter		Min.	Typ.	Max.	Units	Conditions		
BV <sub>DSS</sub>	Drain-to-Source Breakdown Voltage	Q1&Q2	30	—	—	V	V <sub>GS</sub> = 0V, I <sub>D</sub> = 250μA		
ΔBV <sub>DSS</sub> /ΔT <sub>J</sub>	Breakdown Voltage Temp. Coefficient	Q1	—	0.024	—	V/°C	Reference to 25°C, I <sub>D</sub> = 1mA		
		Q2	—	0.024	—				
R <sub>DS(on)</sub>	Static Drain-to-Source On-Resistance	Q1	—	13.7	16.4	mΩ	V <sub>GS</sub> = 10V, I <sub>D</sub> = 9.1A ③ V <sub>GS</sub> = 4.5V, I <sub>D</sub> = 7.3A ③ V <sub>GS</sub> = 10V, I <sub>D</sub> = 11A ③ V <sub>GS</sub> = 4.5V, I <sub>D</sub> = 8.8A ③		
			—	17.1	20.5				
		Q2	—	9.8	11.8				
			—	11.5	13.7				
V <sub>GS(th)</sub>	Gate Threshold Voltage	Q1&Q2	1.35	1.8	2.35	V	Q1: V <sub>DS</sub> = V <sub>GS</sub> , I <sub>D</sub> = 25μA Q2: V <sub>DS</sub> = V <sub>GS</sub> , I <sub>D</sub> = 50μA		
ΔV <sub>GS(th)</sub> /ΔT <sub>J</sub>	Gate Threshold Voltage Coefficient	Q1	—	-4.6	—	mV/°C			
		Q2	—	-4.9	—				
I <sub>DSS</sub>	Drain-to-Source Leakage Current	Q1&Q2	—	—	1.0	μA	V <sub>DS</sub> = 24V, V <sub>GS</sub> = 0V V <sub>DS</sub> = 24V, V <sub>GS</sub> = 0V, T <sub>J</sub> = 125°C		
		Q1&Q2	—	—	150				
I <sub>GSS</sub>	Gate-to-Source Forward Leakage	Q1&Q2	—	—	100	nA	V <sub>GS</sub> = 20V		
	Gate-to-Source Reverse Leakage	Q1&Q2	—	—	-100		V <sub>GS</sub> = -20V		
g <sub>fs</sub>	Forward Transconductance	Q1	19	—	—	S	V <sub>DS</sub> = 15V, I <sub>D</sub> = 7.0A		
		Q2	24	—	—		V <sub>DS</sub> = 15V, I <sub>D</sub> = 8.8A		
Q <sub>g</sub>	Total Gate Charge	Q1	—	6.7	10	nC	Q1 V <sub>DS</sub> = 15V V <sub>GS</sub> = 4.5V, I <sub>D</sub> = 7.0A  Q2 V <sub>DS</sub> = 15V V <sub>GS</sub> = 4.5V, I <sub>D</sub> = 8.8A		
		Q2	—	14	21				
Q <sub>gs1</sub>	Pre-V <sub>th</sub> Gate-to-Source Charge	Q1	—	1.3	—				
		Q2	—	3.0	—				
Q <sub>gs2</sub>	Post-V <sub>th</sub> Gate-to-Source Charge	Q1	—	0.7	—				
		Q2	—	1.3	—				
Q <sub>gd</sub>	Gate-to-Drain Charge	Q1	—	2.5	—				
		Q2	—	4.9	—				
Q <sub>godr</sub>	Gate Charge Overdrive	Q1	—	2.2	—				
		Q2	—	4.8	—				
Q <sub>sw</sub>	Switch Charge (Q <sub>gs2</sub> + Q <sub>gd</sub> )	Q1	—	3.2	—				
		Q2	—	6.2	—				
Q <sub>oss</sub>	Output Charge	Q1	—	4.5	—	nC	V <sub>DS</sub> = 16V, V <sub>GS</sub> = 0V		
		Q2	—	9.0	—				
R <sub>G</sub>	Gate Resistance	Q1	—	2.6	4.7	Ω			
		Q2	—	3.0	5.0				
t <sub>d(on)</sub>	Turn-On Delay Time	Q1	—	6.0	—	ns	Q1 V <sub>DD</sub> = 15V, V <sub>GS</sub> = 4.5V I <sub>D</sub> = 7.0A  Q2 V <sub>DD</sub> = 15V, V <sub>GS</sub> = 4.5V I <sub>D</sub> = 8.8A Clamped Inductive Load		
		Q2	—	8.0	—				
t <sub>r</sub>	Rise Time	Q1	—	9.3	—				
		Q2	—	14	—				
t <sub>d(off)</sub>	Turn-Off Delay Time	Q1	—	8.0	—				
		Q2	—	13	—				
t <sub>f</sub>	Fall Time	Q1	—	3.4	—				
		Q2	—	5.3	—				
C <sub>iss</sub>	Input Capacitance	Q1	—	850	—			pF	V <sub>GS</sub> = 0V V <sub>DS</sub> = 15V f = 1.0MHz
		Q2	—	1790	—				
C <sub>oss</sub>	Output Capacitance	Q1	—	190	—				
		Q2	—	390	—				
C <sub>rss</sub>	Reverse Transfer Capacitance	Q1	—	88	—				
		Q2	—	190	—				

## Avalanche Characteristics

	Parameter	Typ.	Q1 Max.	Q2 Max.	Units
E <sub>AS</sub>	Single Pulse Avalanche Energy ②	—	10	15	mJ
I <sub>AR</sub>	Avalanche Current ①	—	7.0	8.8	A

## Diode Characteristics

	Parameter		Min.	Typ.	Max.	Units	Conditions
I <sub>S</sub>	Continuous Source Current (Body Diode)	Q1	—	—	2.8	A	MOSFET symbol showing the integral reverse p-n junction diode.
		Q2	—	—	2.8		
I <sub>SM</sub>	Pulsed Source Current (Body Diode) ①	Q1	—	—	76	A	
		Q2	—	—	85		
V <sub>SD</sub>	Diode Forward Voltage	Q1	—	—	1.0	V	T <sub>J</sub> = 25°C, I <sub>S</sub> = 7.3A, V <sub>GS</sub> = 0V ③ T <sub>J</sub> = 25°C, I <sub>S</sub> = 8.8A, V <sub>GS</sub> = 0V ③
		Q2	—	—	1.0		
t <sub>rr</sub>	Reverse Recovery Time	Q1	—	12	18	ns	Q1 T <sub>J</sub> = 25°C, I <sub>F</sub> = 7.0A, V <sub>DD</sub> = 15V, di/dt = 100A/μs ③
		Q2	—	16	24		
Q <sub>rr</sub>	Reverse Recovery Charge	Q1	—	4.1	6.1	nC	Q2 T <sub>J</sub> = 25°C, I <sub>F</sub> = 8.8A, V <sub>DD</sub> = 15V, di/dt = 100A/μs ③
		Q2	—	5.9	8.9		

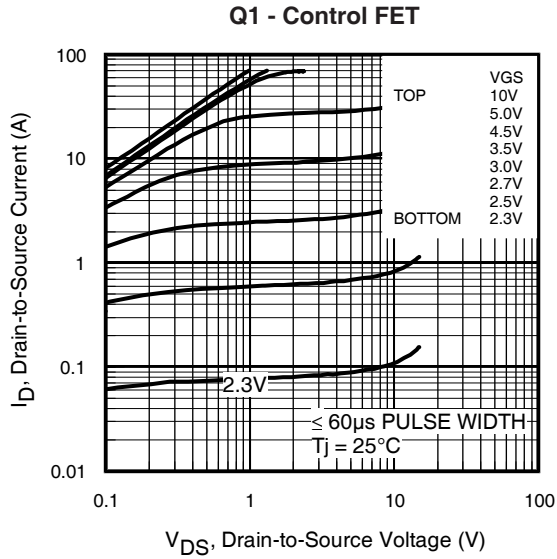

Fig 1. Typical Output Characteristics

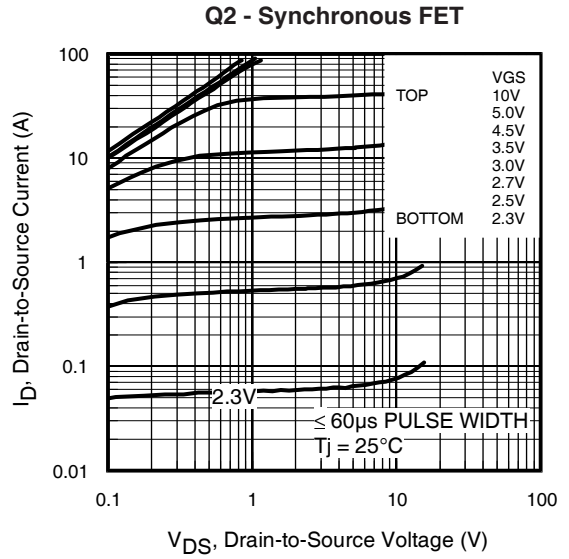

Fig 2. Typical Output Characteristics

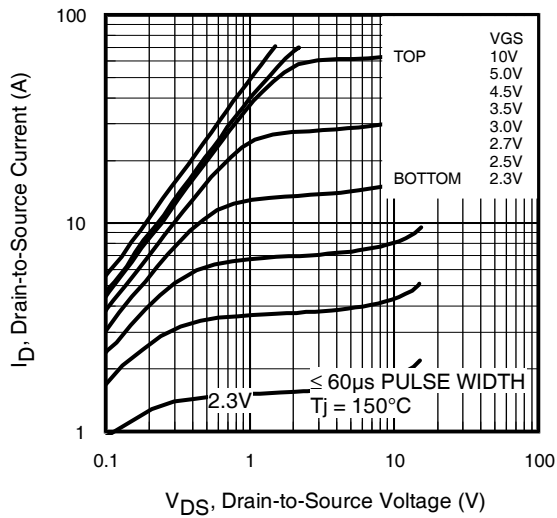

Fig 3. Typical Output Characteristics

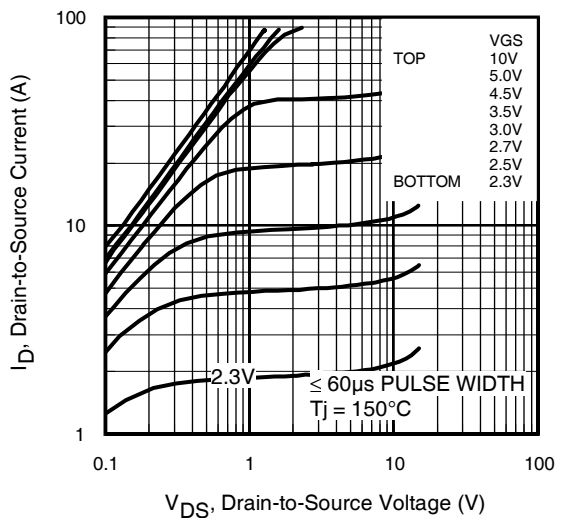

Fig 4. Typical Output Characteristics

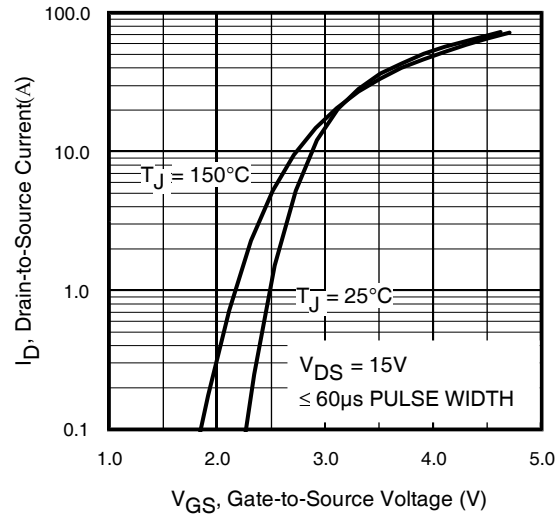

Fig 5. Typical Transfer Characteristics

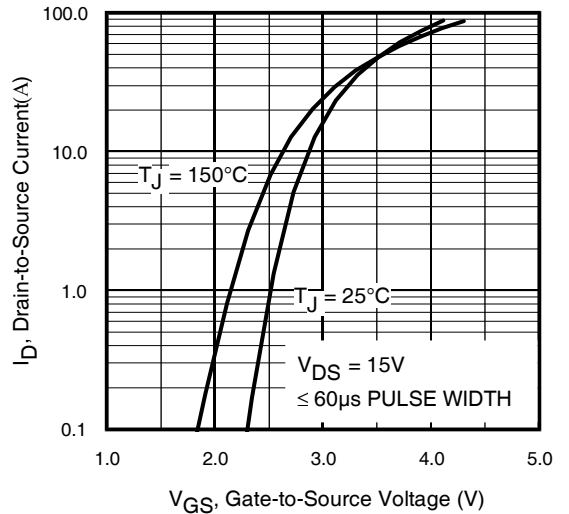
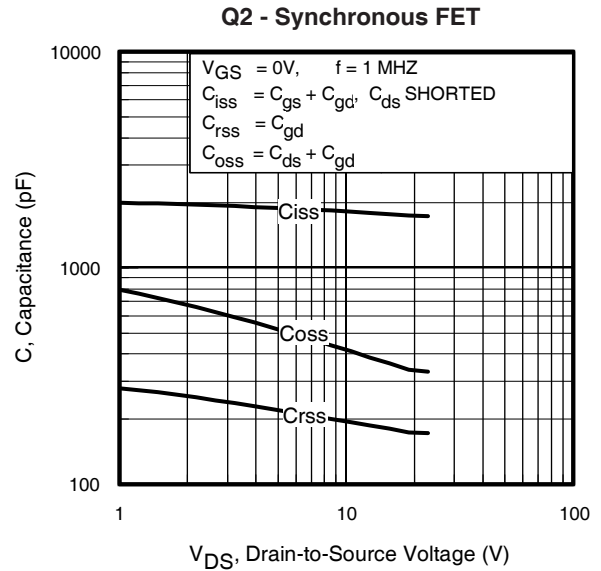
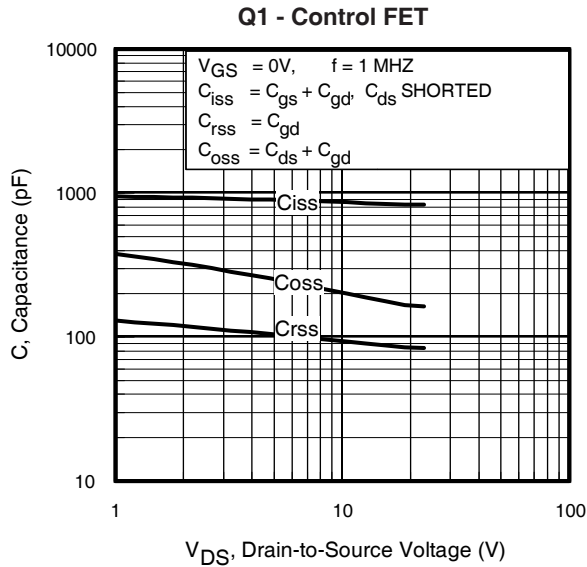
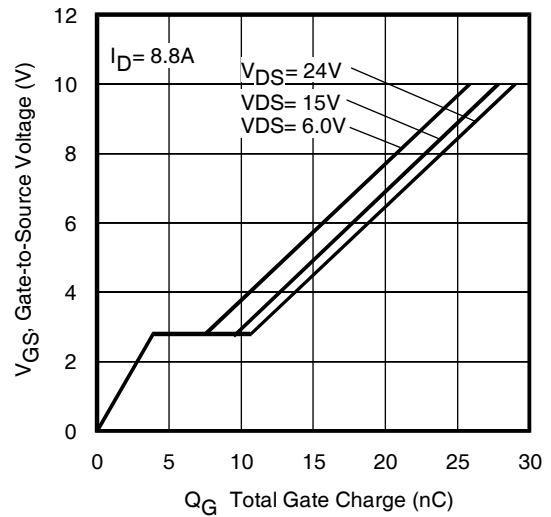
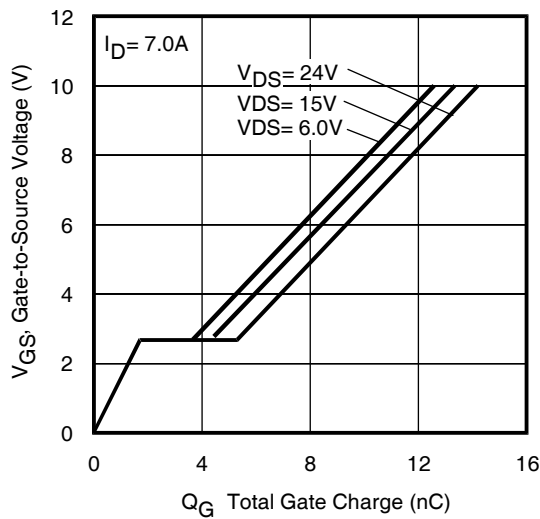

Fig 6. Typical Transfer Characteristics

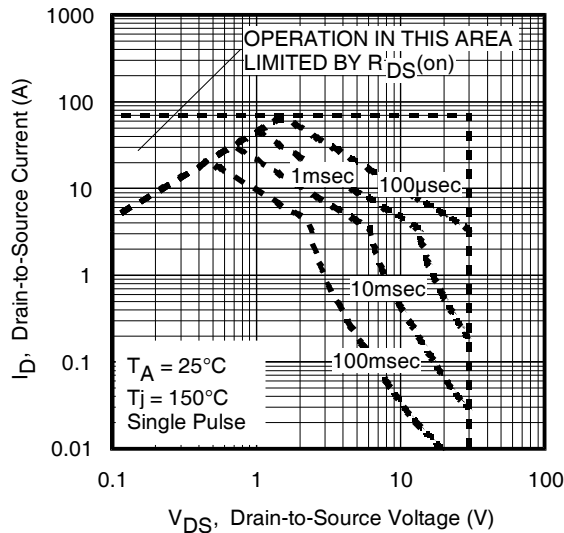

**Fig 7.** Typical Capacitance vs. Drain-to-Source Voltage **Fig 8.** Typical Capacitance vs. Drain-to-Source Voltage

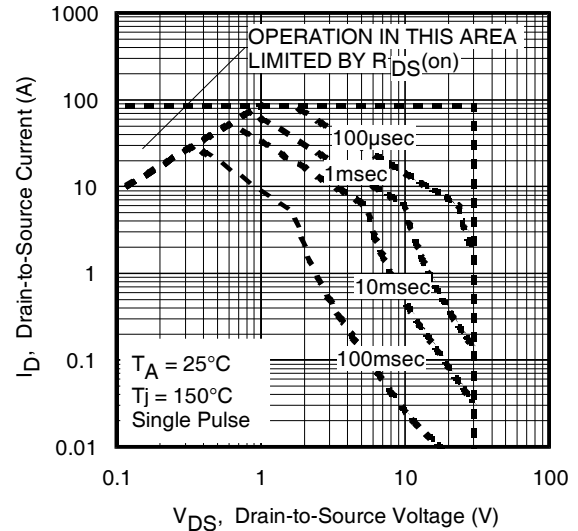

**Fig 9.** Typical Gate Charge vs. Gate-to-Source Voltage

**Fig 10.** Typical Gate Charge vs. Gate-to-Source Voltage



**Fig 11.** Maximum Safe Operating Area



**Fig 12.** Maximum Safe Operating Area

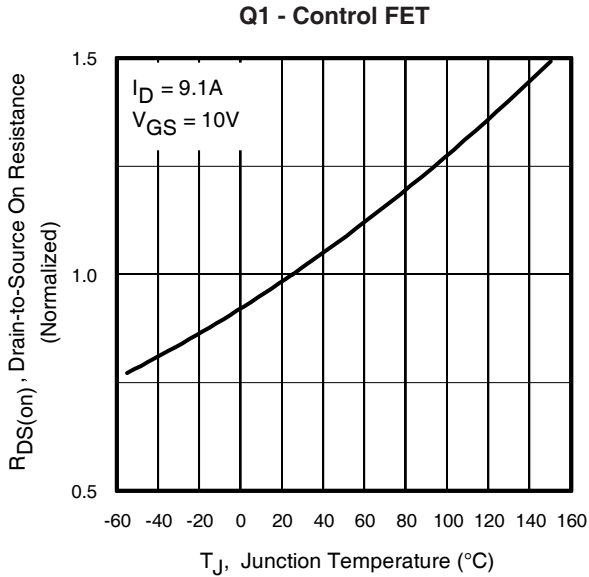

**Fig 13.** Normalized On-Resistance vs. Temperature

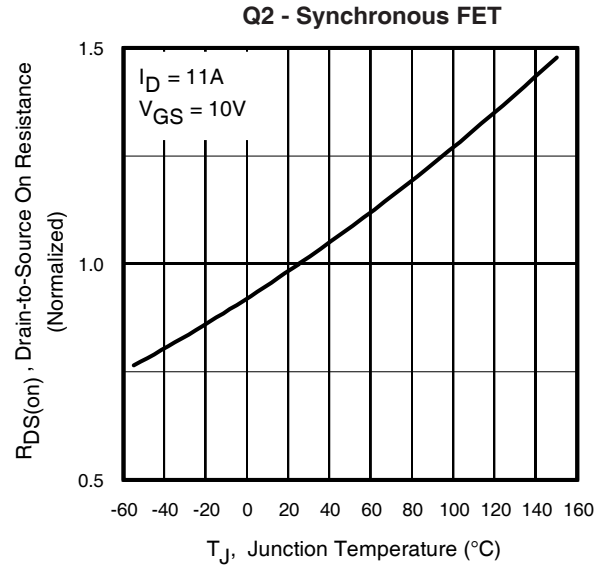

**Fig 14.** Normalized On-Resistance vs. Temperature

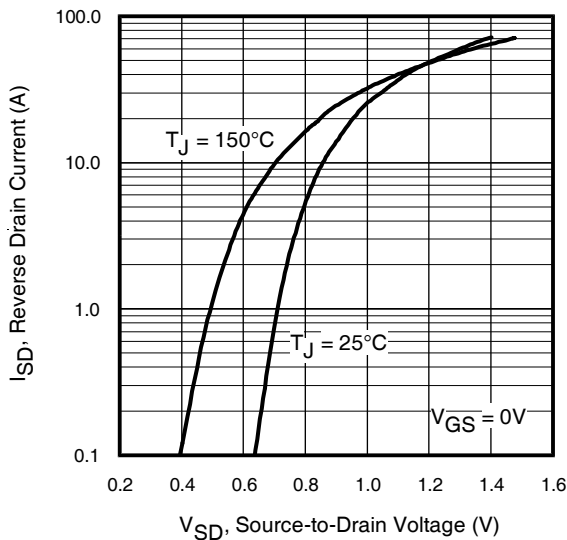

**Fig 15.** Typical Source-Drain Diode Forward Voltage

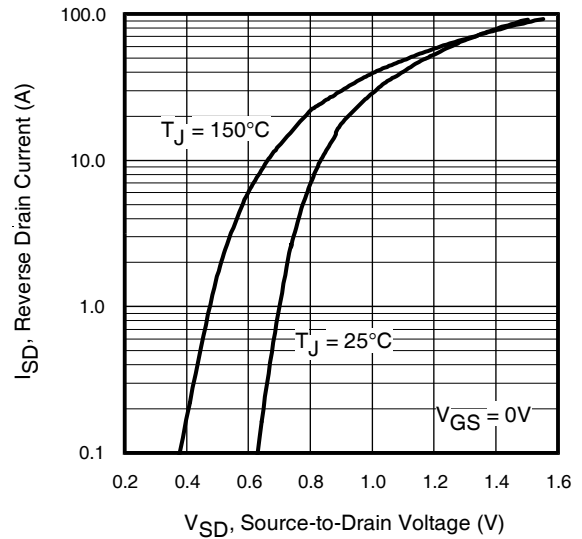

**Fig 16.** Typical Source-Drain Diode Forward Voltage

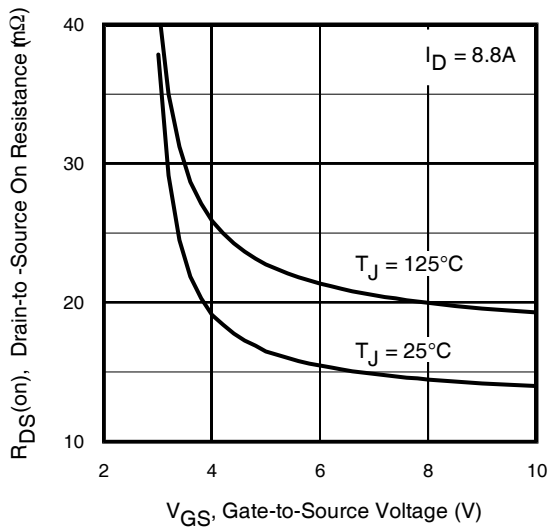

**Fig 17.** Typical On-Resistance vs. Gate Voltage

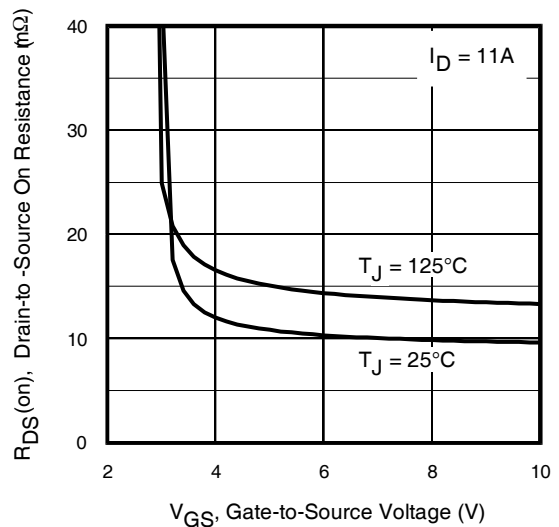

**Fig 18.** Typical On-Resistance vs. Gate Voltage

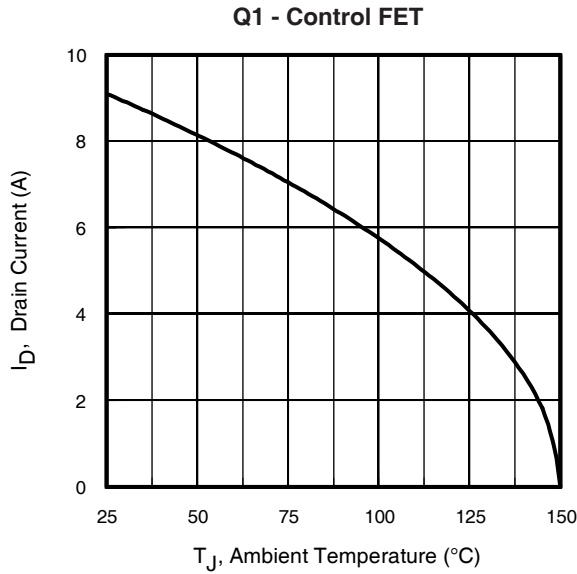

**Fig 19.** Maximum Drain Current vs. Ambient Temp.

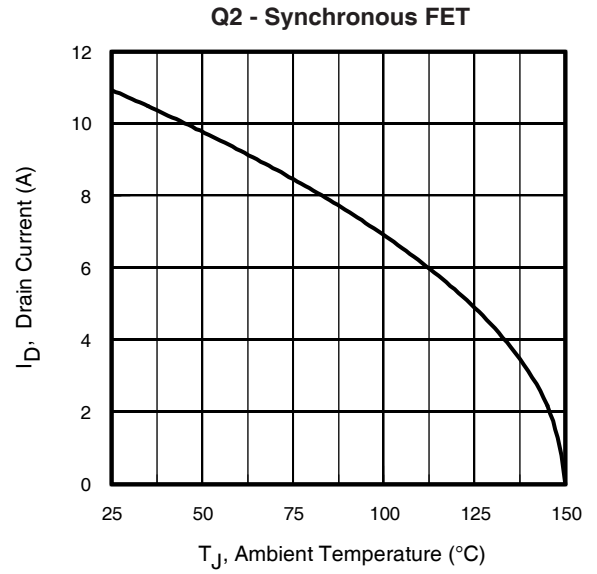

**Fig 20.** Maximum Drain Current vs. Ambient Temp.

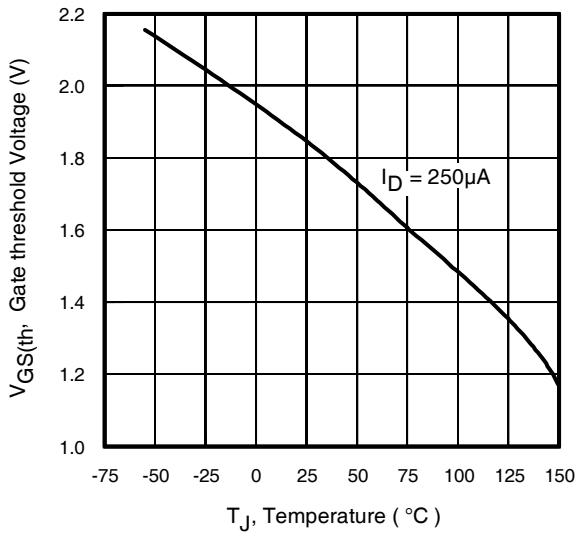

**Fig 21.** Threshold Voltage vs. Temperature

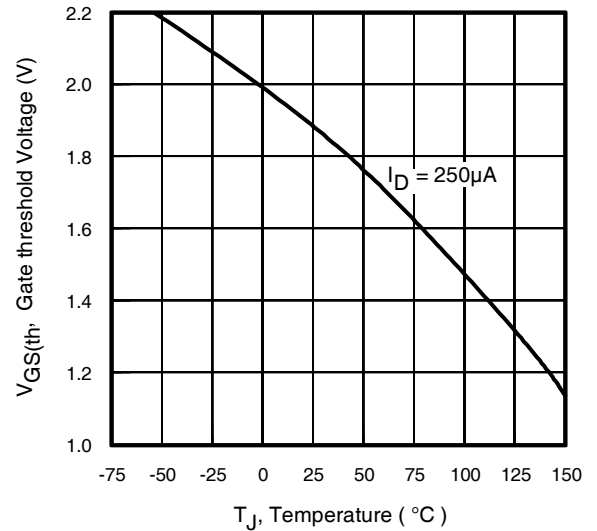

**Fig 22.** Threshold Voltage vs. Temperature

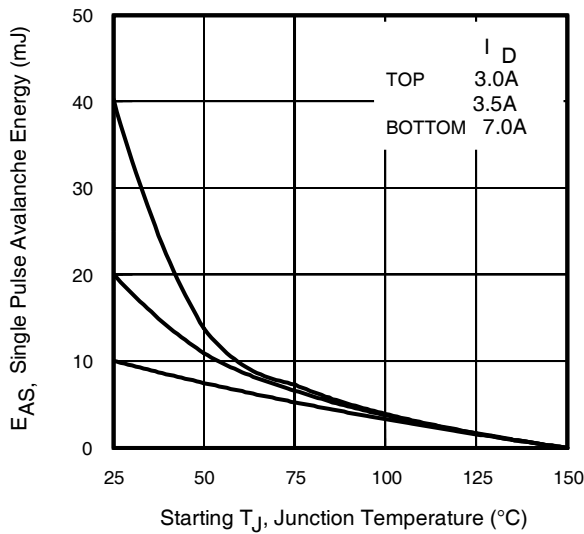

**Fig 23.** Maximum Avalanche Energy vs. Drain Current

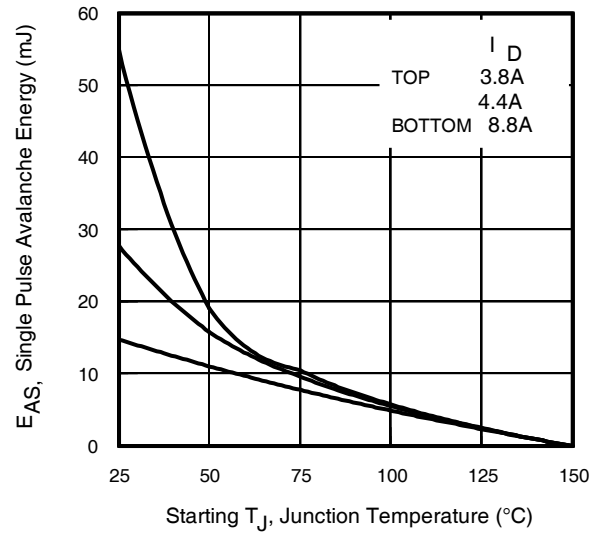

**Fig 24.** Maximum Avalanche Energy vs. Drain Current

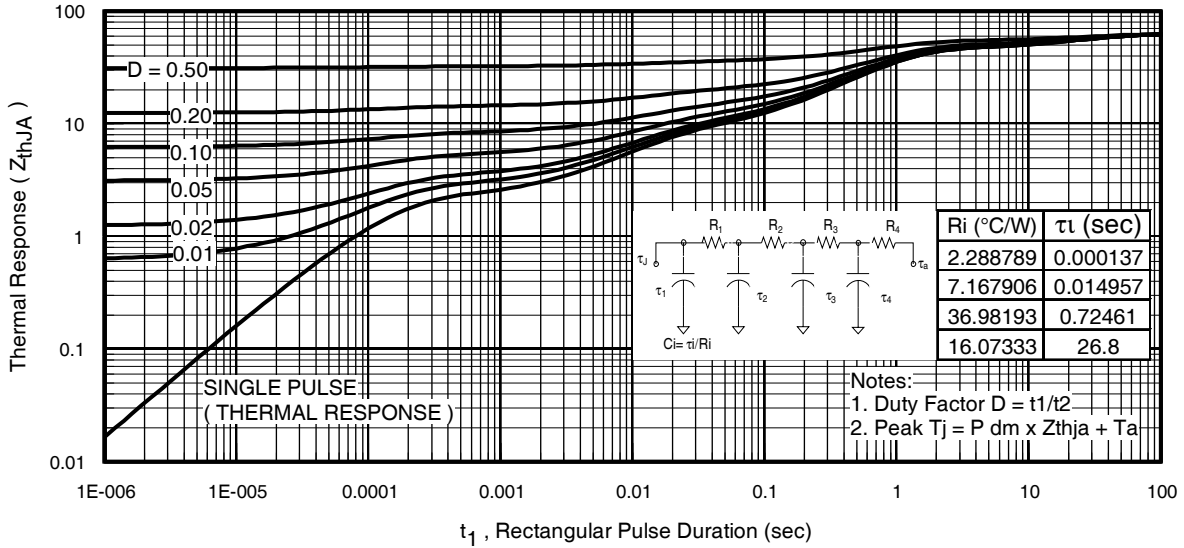

Fig 25. Maximum Effective Transient Thermal Impedance, Junction-to-Ambient (Q1)

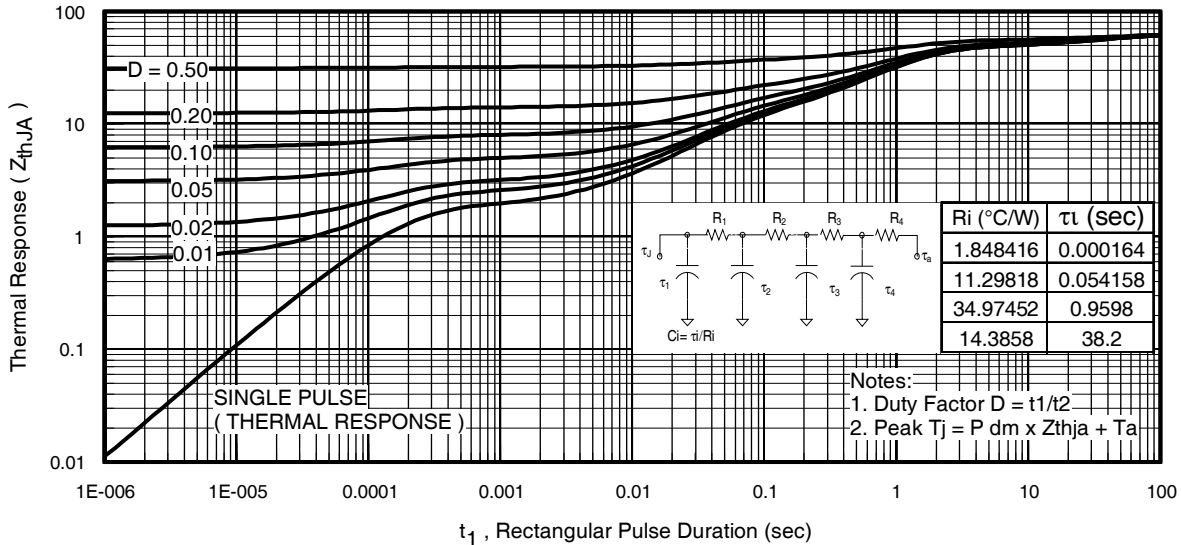

Fig 26. Maximum Effective Transient Thermal Impedance, Junction-to-Ambient (Q2)

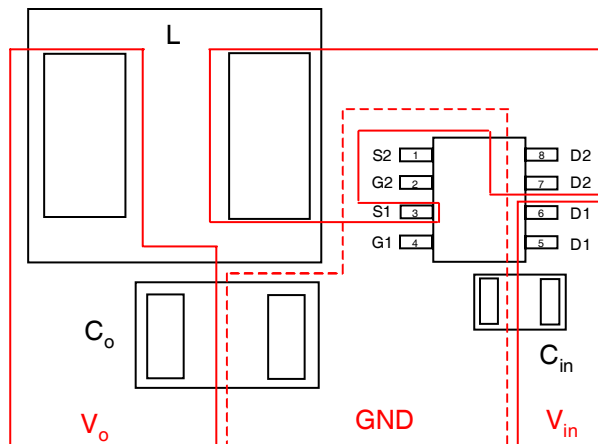
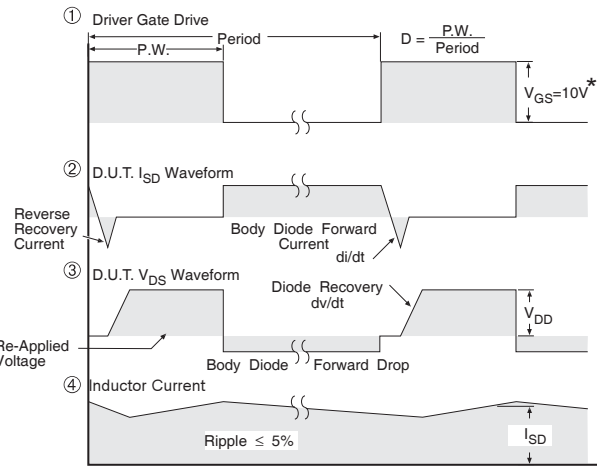
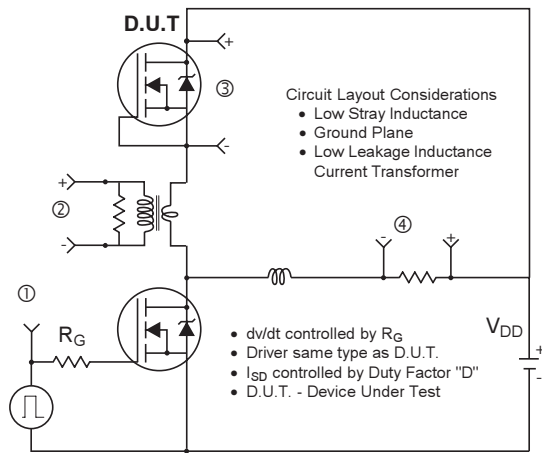
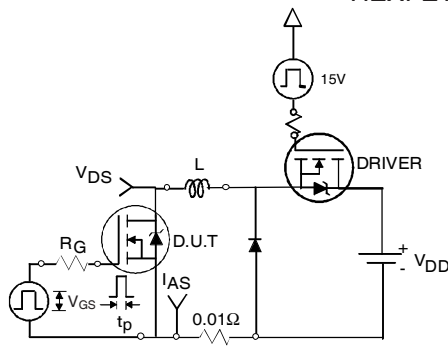

Fig 27. Layout Diagram



\*  $V_{GS} = 5V$  for Logic Level Devices

**Fig 28. Peak Diode Recovery  $dv/dt$  Test Circuit for N-Channel HEXFET<sup>®</sup> Power MOSFETs**



**Fig 29a. Unclamped Inductive Test Circuit**

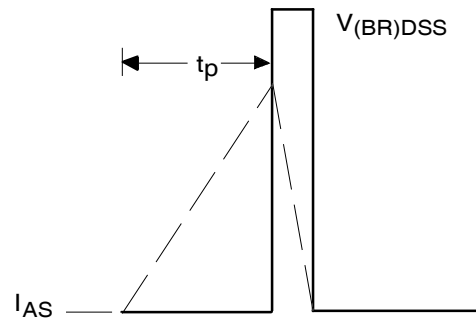

**Fig 29b. Unclamped Inductive Waveforms**

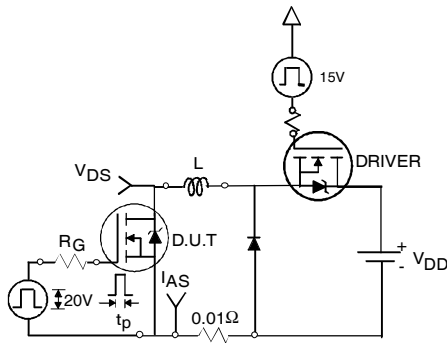

**Fig 30a. Switching Time Test Circuit**

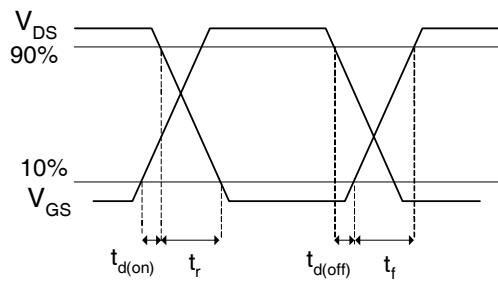

**Fig 30b. Switching Time Waveforms**

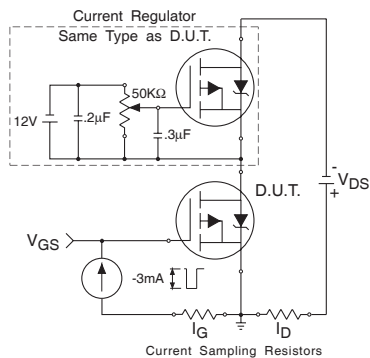

**Fig 31a. Gate Charge Test Circuit**

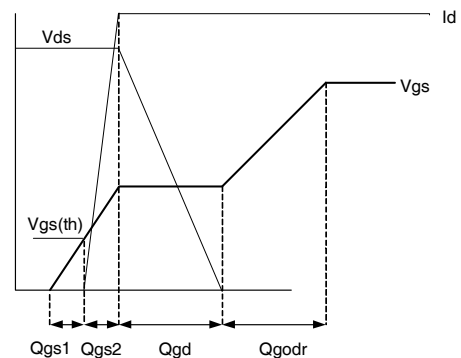
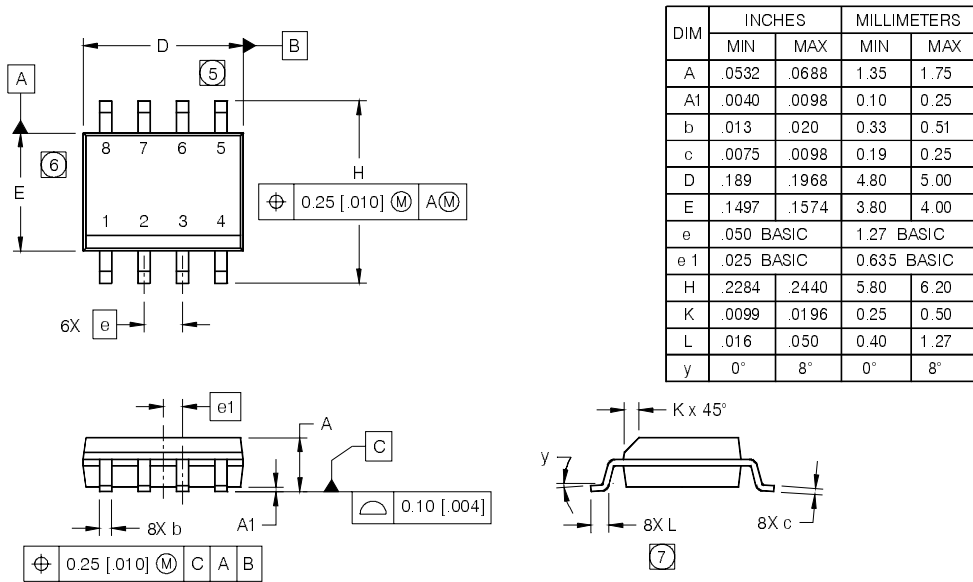

**Fig 31b. Gate Charge Waveform**



## SO-8 Package Outline (MOSFET & Fetky)

Dimensions are shown in millimeters (inches)



**NOTES:**

1. DIMENSIONING & TOLERANCING PER ASME Y14.5M-1994.
2. CONTROLLING DIMENSION: MILLIMETER
3. DIMENSIONS ARE SHOWN IN MILLIMETERS [INCHES].
4. OUTLINE CONFORMS TO JEDEC OUTLINE MS-012AA.
- ⑤ DIMENSION DOES NOT INCLUDE MOLD PROTRUSIONS. MOLD PROTRUSIONS NOT TO EXCEED 0.15 [0.006].
- ⑥ DIMENSION DOES NOT INCLUDE MOLD PROTRUSIONS. MOLD PROTRUSIONS NOT TO EXCEED 0.25 [0.010].
- ⑦ DIMENSION IS THE LENGTH OF LEAD FOR SOLDERING TO A SUBSTRATE.

**FOOTPRINT**

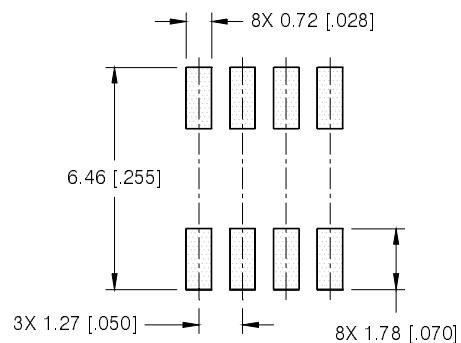

## SO-8 Part Marking Information

EXAMPLE: THIS IS AN IRF7101 (MOSFET)

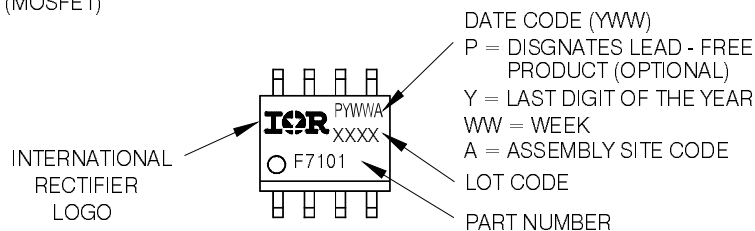

Note: For the most current drawing please refer to IR website at: <http://www.irf.com/package/>

## SO-8 Tape and Reel

Dimensions are shown in millimeters (inches)

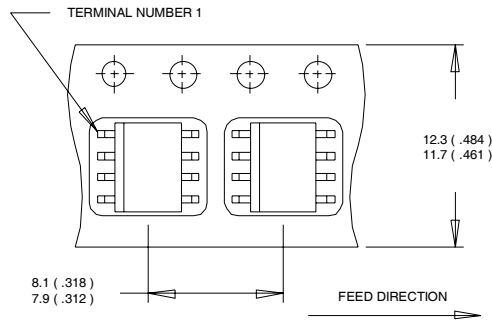

- NOTES:
1. CONTROLLING DIMENSION : MILLIMETER.
  2. ALL DIMENSIONS ARE SHOWN IN MILLIMETERS(INCHES).
  3. OUTLINE CONFORMS TO EIA-481 & EIA-541.

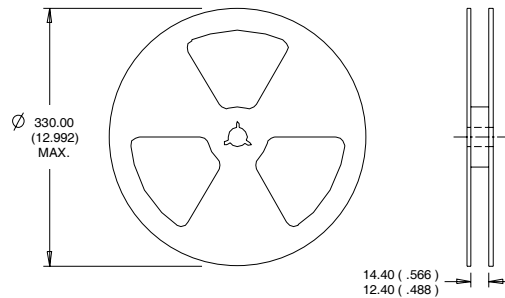

- NOTES :
1. CONTROLLING DIMENSION : MILLIMETER.
  2. OUTLINE CONFORMS TO EIA-481 & EIA-541.

**Note:** For the most current drawing please refer to IR website at: <http://www.irf.com/package/>

### Notes:

- ① Repetitive rating; pulse width limited by max. junction temperature.
- ② Starting  $T_J = 25^\circ\text{C}$ , Q1:  $L = 0.41\text{mH}$ ,  $R_G = 25\Omega$ ,  $I_{AS} = 7.0\text{A}$ ;  
Q2:  $L = 0.38\text{mH}$ ,  $R_G = 25\Omega$ ,  $I_{AS} = 8.8\text{A}$ .
- ③ Pulse width  $\leq 400\mu\text{s}$ ; duty cycle  $\leq 2\%$ .
- ④ When mounted on 1 inch square copper board.
- ⑤  $R_\theta$  is measured at  $T_J$  approximately  $90^\circ\text{C}$ .

Data and specifications subject to change without notice.  
This product has been designed and qualified for the Consumer market.  
Qualification Standards can be found on IR's Web site.

单击下面可查看定价，库存，交付和生命周期等信息

[>>Infineon Technologies\(英飞凌\)](#)