

WARP2 SERIES IGBT WITH  
ULTRAFAST SOFT RECOVERY DIODE

**Applications**

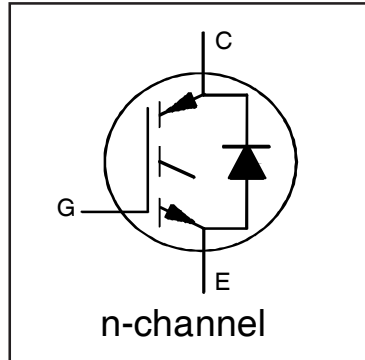
- Telecom and Server SMPS
- PFC and ZVS SMPS Circuits
- Uninterruptable Power Supplies
- Consumer Electronics Power Supplies
- Lead-Free

**Features**

- NPT Technology, Positive Temperature Coefficient
- Lower  $V_{CE(SAT)}$
- Lower Parasitic Capacitances
- Minimal Tail Current
- HEXFRED Ultra Fast Soft-Recovery Co-Pack Diode
- Tighter Distribution of Parameters
- Higher Reliability

**Benefits**

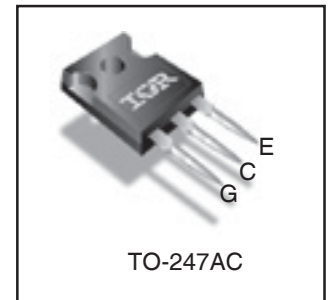
- Parallel Operation for Higher Current Applications
- Lower Conduction Losses and Switching Losses
- Higher Switching Frequency up to 150kHz



$V_{CES} = 600V$   
 $V_{CE(on)} \text{ typ.} = 1.85V$   
 @  $V_{GE} = 15V$   $I_C = 22A$

**Equivalent MOSFET Parameters**<sup>①</sup>

$R_{CE(on)} \text{ typ.} = 84m\Omega$   
 $I_D$  (FET equivalent) = 35A



**Absolute Maximum Ratings**

	Parameter	Max.	Units
$V_{CES}$	Collector-to-Emitter Voltage	600	V
$I_C$ @ $T_C = 25^\circ C$	Continuous Collector Current	60	A
$I_C$ @ $T_C = 100^\circ C$	Continuous Collector Current	34	
$I_{CM}$	Pulse Collector Current (Ref. Fig. C.T.4)	120	
$I_{LM}$	Clamped Inductive Load Current <sup>②</sup>	120	
$I_F$ @ $T_C = 25^\circ C$	Diode Continuous Forward Current	40	
$I_F$ @ $T_C = 100^\circ C$	Diode Continuous Forward Current	15	
$I_{FRM}$	Maximum Repetitive Forward Current <sup>③</sup>	60	
$V_{GE}$	Gate-to-Emitter Voltage	$\pm 20$	
$P_D$ @ $T_C = 25^\circ C$	Maximum Power Dissipation	308	W
$P_D$ @ $T_C = 100^\circ C$	Maximum Power Dissipation	123	
$T_J$	Operating Junction and	-55 to +150	$^\circ C$
$T_{STG}$	Storage Temperature Range		
	Soldering Temperature for 10 sec.		
	Mounting Torque, 6-32 or M3 Screw	10 lbf·in (1.1 N·m)	

**Thermal Resistance**

	Parameter	Min.	Typ.	Max.	Units
$R_{\theta JC}$ (IGBT)	Thermal Resistance Junction-to-Case (each IGBT)	—	—	0.41	$^\circ C/W$
$R_{\theta JC}$ (Diode)	Thermal Resistance Junction-to-Case (each Diode)	—	—	1.7	
$R_{\theta CS}$	Thermal Resistance, Case-to-Sink (flat, greased surface)	—	0.24	—	
$R_{\theta JA}$	Thermal Resistance, Junction-to-Ambient (typical socket mount)	—	—	40	
	Weight	—	6.0 (0.21)	—	g (oz)

## Electrical Characteristics @ T<sub>J</sub> = 25°C (unless otherwise specified)

	Parameter	Min.	Typ.	Max.	Units	Conditions	Ref.Fig
V <sub>(BR)CES</sub>	Collector-to-Emitter Breakdown Voltage	600	—	—	V	V <sub>GE</sub> = 0V, I <sub>C</sub> = 500μA	
ΔV <sub>(BR)CES</sub> /ΔT <sub>J</sub>	Temperature Coeff. of Breakdown Voltage	—	0.78	—	V/°C	V <sub>GE</sub> = 0V, I <sub>C</sub> = 1mA (25°C-125°C)	
R <sub>G</sub>	Internal Gate Resistance	—	1.7	—	Ω	1MHz, Open Collector	
V <sub>CE(on)</sub>	Collector-to-Emitter Saturation Voltage	—	1.85	2.15	V	I <sub>C</sub> = 22A, V <sub>GE</sub> = 15V	4, 5, 6, 8, 9
		—	2.25	2.55		I <sub>C</sub> = 35A, V <sub>GE</sub> = 15V	
		—	2.37	2.80		I <sub>C</sub> = 22A, V <sub>GE</sub> = 15V, T <sub>J</sub> = 125°C	
		—	3.00	3.45		I <sub>C</sub> = 35A, V <sub>GE</sub> = 15V, T <sub>J</sub> = 125°C	
V <sub>GE(th)</sub>	Gate Threshold Voltage	3.0	4.0	5.0	V	I <sub>C</sub> = 250μA	7, 8, 9
ΔV <sub>GE(th)</sub> /ΔT <sub>J</sub>	Threshold Voltage temp. coefficient	—	-10	—	mV/°C	V <sub>CE</sub> = V <sub>GE</sub> , I <sub>C</sub> = 1.0mA	
g <sub>fe</sub>	Forward Transconductance	—	36	—	S	V <sub>CE</sub> = 50V, I <sub>C</sub> = 22A, PW = 80μs	
I <sub>CES</sub>	Collector-to-Emitter Leakage Current	—	3.0	375	μA	V <sub>GE</sub> = 0V, V <sub>CE</sub> = 600V	
		—	0.35	—	mA	V <sub>GE</sub> = 0V, V <sub>CE</sub> = 600V, T <sub>J</sub> = 125°C	
V <sub>FM</sub>	Diode Forward Voltage Drop	—	1.30	1.70	V	I <sub>F</sub> = 15A, V <sub>GE</sub> = 0V	10
		—	1.20	1.60		I <sub>F</sub> = 15A, V <sub>GE</sub> = 0V, T <sub>J</sub> = 125°C	
I <sub>GES</sub>	Gate-to-Emitter Leakage Current	—	—	±100	nA	V <sub>GE</sub> = ±20V, V <sub>CE</sub> = 0V	

## Switching Characteristics @ T<sub>J</sub> = 25°C (unless otherwise specified)

	Parameter	Min.	Typ.	Max.	Units	Conditions	Ref.Fig
Q <sub>g</sub>	Total Gate Charge (turn-on)	—	160	240	nC	I <sub>C</sub> = 22A	17
Q <sub>gc</sub>	Gate-to-Collector Charge (turn-on)	—	55	83		V <sub>CC</sub> = 400V	CT1
Q <sub>ge</sub>	Gate-to-Emitter Charge (turn-on)	—	21	32		V <sub>GE</sub> = 15V	
E <sub>on</sub>	Turn-On Switching Loss	—	220	270	μJ	I <sub>C</sub> = 22A, V <sub>CC</sub> = 390V	CT3
E <sub>off</sub>	Turn-Off Switching Loss	—	215	265		V <sub>GE</sub> = +15V, R <sub>G</sub> = 3.3Ω, L = 200μH	
E <sub>total</sub>	Total Switching Loss	—	435	535		T <sub>J</sub> = 25°C ⊕	
t <sub>d(on)</sub>	Turn-On delay time	—	26	34	ns	I <sub>C</sub> = 22A, V <sub>CC</sub> = 390V	CT3
t <sub>r</sub>	Rise time	—	6.0	8.0		V <sub>GE</sub> = +15V, R <sub>G</sub> = 3.3Ω, L = 200μH	
t <sub>d(off)</sub>	Turn-Off delay time	—	110	122		T <sub>J</sub> = 25°C ⊕	
t <sub>f</sub>	Fall time	—	8.0	10	μJ	I <sub>C</sub> = 22A, V <sub>CC</sub> = 390V V <sub>GE</sub> = +15V, R <sub>G</sub> = 3.3Ω, L = 200μH T <sub>J</sub> = 125°C ⊕	CT3 11, 13 WF1, WF2
E <sub>on</sub>	Turn-On Switching Loss	—	410	465			
E <sub>off</sub>	Turn-Off Switching Loss	—	330	405			
E <sub>total</sub>	Total Switching Loss	—	740	870	ns	I <sub>C</sub> = 22A, V <sub>CC</sub> = 390V V <sub>GE</sub> = +15V, R <sub>G</sub> = 3.3Ω, L = 200μH T <sub>J</sub> = 125°C ⊕	CT3 12, 14 WF1, WF2
t <sub>d(on)</sub>	Turn-On delay time	—	26	34			
t <sub>r</sub>	Rise time	—	8.0	11			
t <sub>d(off)</sub>	Turn-Off delay time	—	130	150	pF	V <sub>GE</sub> = 0V V <sub>CC</sub> = 30V f = 1Mhz	16
t <sub>f</sub>	Fall time	—	12	16			
C <sub>ies</sub>	Input Capacitance	—	3715	—			
C <sub>oes</sub>	Output Capacitance	—	265	—	pF	V <sub>GE</sub> = 0V, V <sub>CE</sub> = 0V to 480V	15
C <sub>res</sub>	Reverse Transfer Capacitance	—	47	—			
C <sub>oes eff.</sub>	Effective Output Capacitance (Time Related) ⊕	—	135	—			
C <sub>oes eff. (ER)</sub>	Effective Output Capacitance (Energy Related) ⊕	—	179	—			
RBSOA	Reverse Bias Safe Operating Area	FULL SQUARE				T <sub>J</sub> = 150°C, I <sub>C</sub> = 120A V <sub>CC</sub> = 480V, V <sub>p</sub> = 600V R <sub>g</sub> = 22Ω, V <sub>GE</sub> = +15V to 0V	3 CT2
t <sub>rr</sub>	Diode Reverse Recovery Time	—	42	60	ns	T <sub>J</sub> = 25°C I <sub>F</sub> = 15A, V <sub>R</sub> = 200V,	19
		—	74	120		T <sub>J</sub> = 125°C di/dt = 200A/μs	
Q <sub>rr</sub>	Diode Reverse Recovery Charge	—	80	180	nC	T <sub>J</sub> = 25°C I <sub>F</sub> = 15A, V <sub>R</sub> = 200V,	21
		—	220	600		T <sub>J</sub> = 125°C di/dt = 200A/μs	
I <sub>rr</sub>	Peak Reverse Recovery Current	—	4.0	6.0	A	T <sub>J</sub> = 25°C I <sub>F</sub> = 15A, V <sub>R</sub> = 200V,	19, 20, 21, 22
		—	6.5	10		T <sub>J</sub> = 125°C di/dt = 200A/μs	

### Notes:

① R<sub>CE(on)</sub> typ. = equivalent on-resistance = V<sub>CE(on)</sub> typ./ I<sub>C</sub>, where V<sub>CE(on)</sub> typ. = 1.85V and I<sub>C</sub> = 22A. I<sub>D</sub> (FET Equivalent) is the equivalent MOSFET I<sub>D</sub> rating @ 25°C for applications up to 150kHz. These are provided for comparison purposes (only) with equivalent MOSFET solutions.

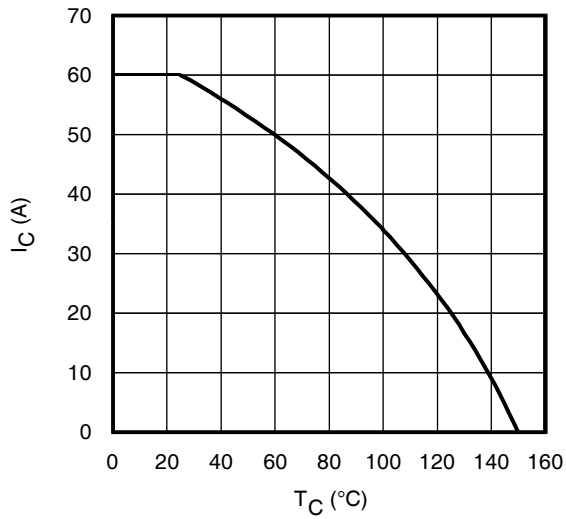
② V<sub>CC</sub> = 80% (V<sub>CES</sub>), V<sub>GE</sub> = 15V, L = 28 μH, R<sub>G</sub> = 22 Ω.

③ Pulse width limited by max. junction temperature.

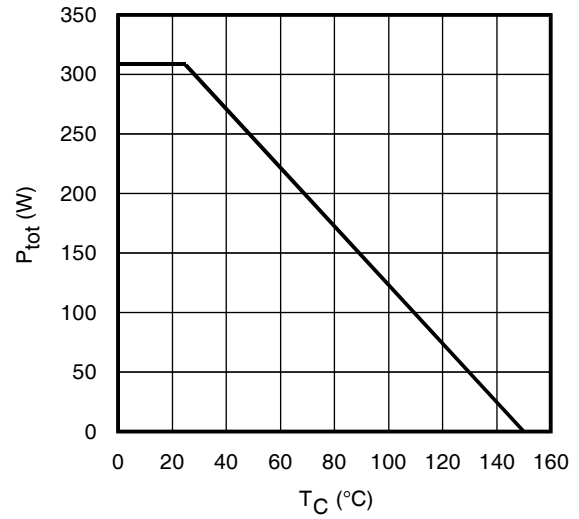
④ Energy losses include "tail" and diode reverse recovery, Data generated with use of Diode 30ETH06.

⑤ C<sub>oes eff.</sub> is a fixed capacitance that gives the same charging time as C<sub>oes</sub> while V<sub>CE</sub> is rising from 0 to 80% V<sub>CES</sub>.

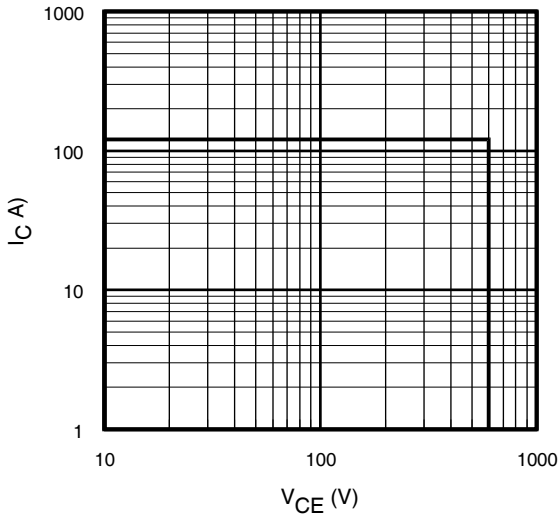
C<sub>oes eff. (ER)</sub> is a fixed capacitance that stores the same energy as C<sub>oes</sub> while V<sub>CE</sub> is rising from 0 to 80% V<sub>CES</sub>.



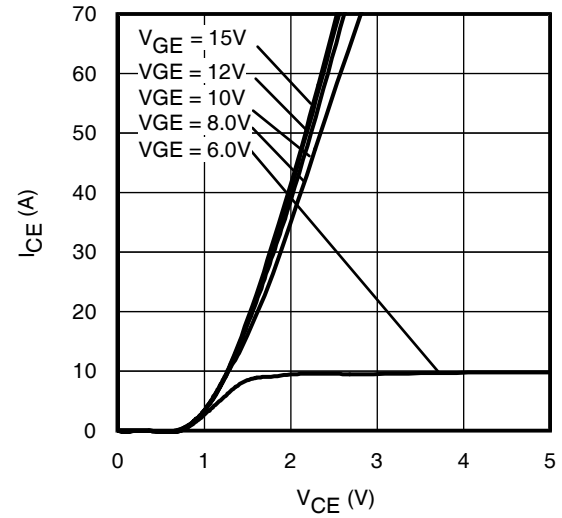
**Fig. 1** - Maximum DC Collector Current vs. Case Temperature



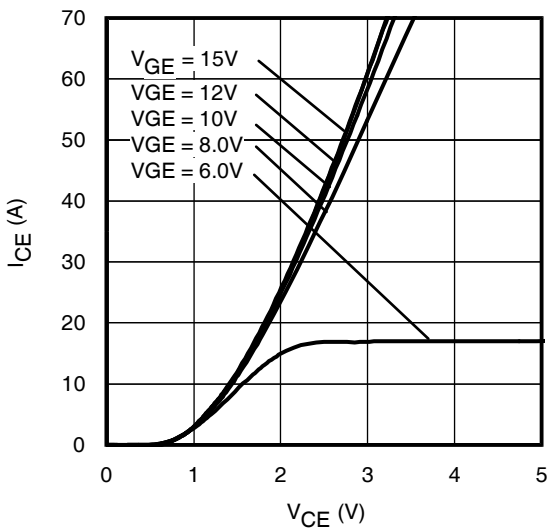
**Fig. 2** - Power Dissipation vs. Case Temperature



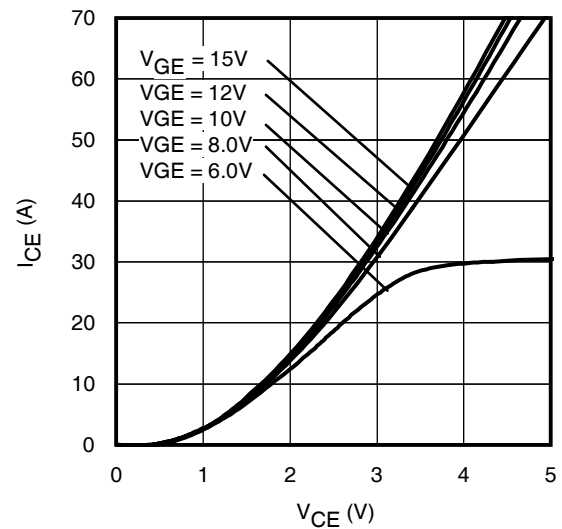
**Fig. 3** - Reverse Bias SOA  
 $T_J = 150^{\circ}C$ ;  $V_{GE} = 15V$



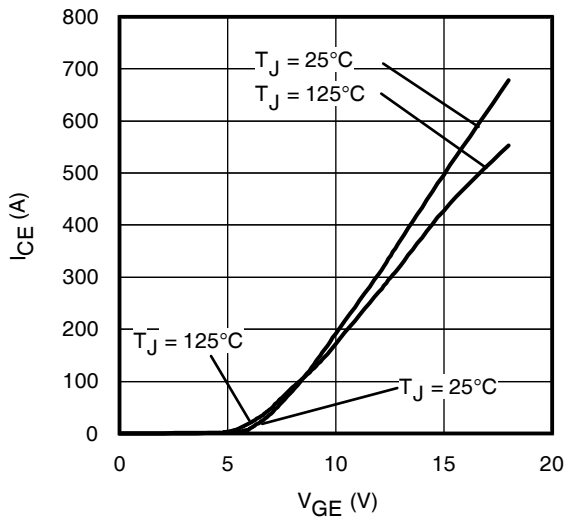
**Fig. 4** - Typ. IGBT Output Characteristics  
 $T_J = -40^{\circ}C$ ;  $t_p = 80\mu s$



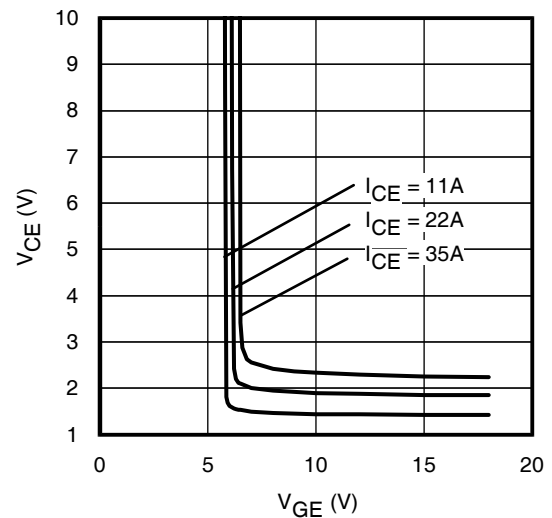
**Fig. 5** - Typ. IGBT Output Characteristics  
 $T_J = 25^{\circ}C$ ;  $t_p = 80\mu s$



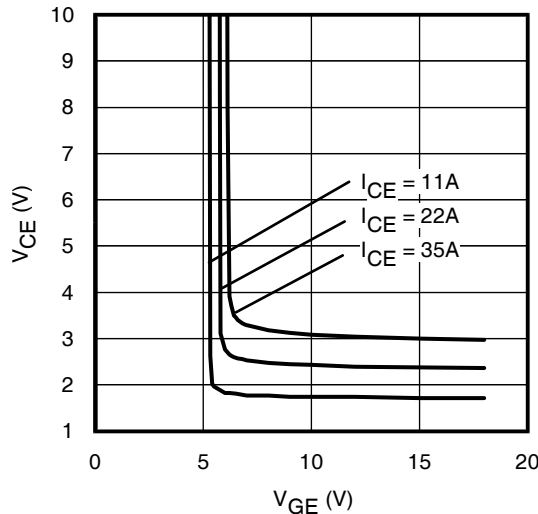
**Fig. 6** - Typ. IGBT Output Characteristics  
 $T_J = 125^{\circ}C$ ;  $t_p = 80\mu s$



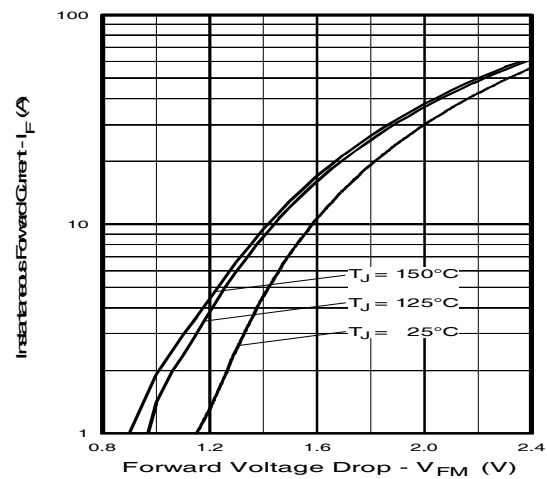
**Fig. 7 - Typ. Transfer Characteristics**  
 $V_{CE} = 50V$ ;  $t_p = 10\mu s$



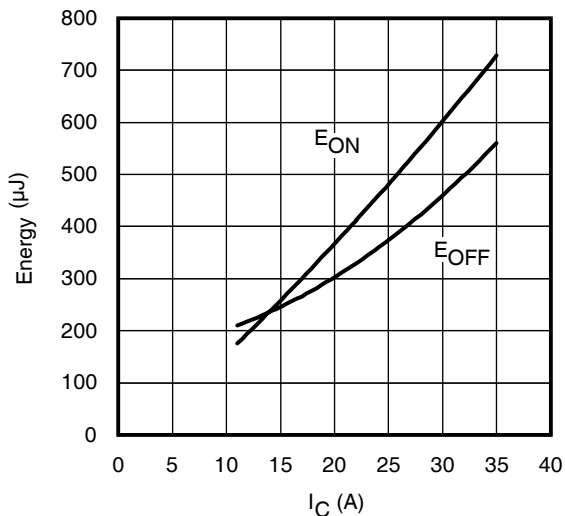
**Fig. 8 - Typical  $V_{CE}$  vs.  $V_{GE}$**   
 $T_J = 25^\circ C$



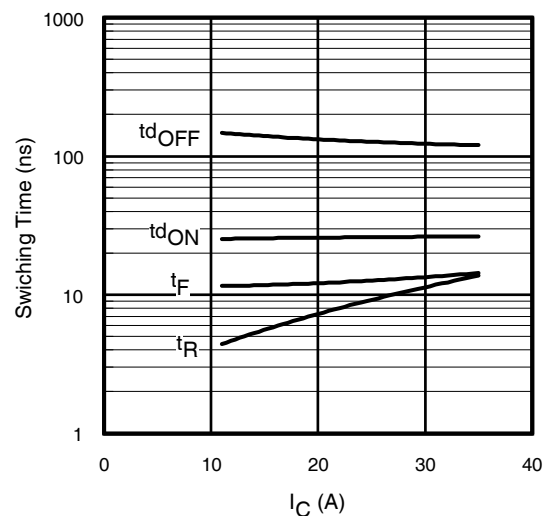
**Fig. 9 - Typical  $V_{CE}$  vs.  $V_{GE}$**   
 $T_J = 125^\circ C$



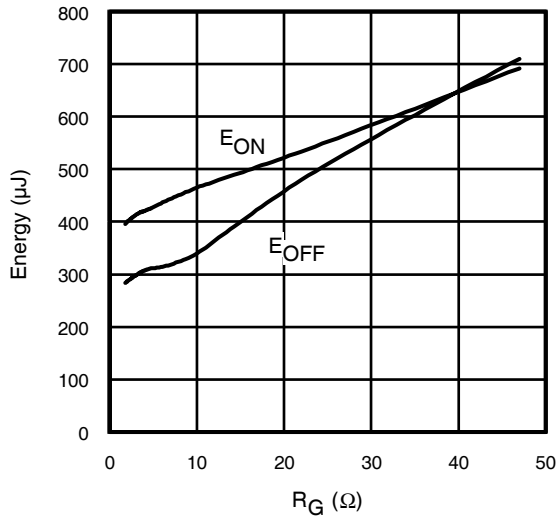
**Fig. 10 - Typ. Diode Forward Characteristics**  
 $t_p = 80\mu s$



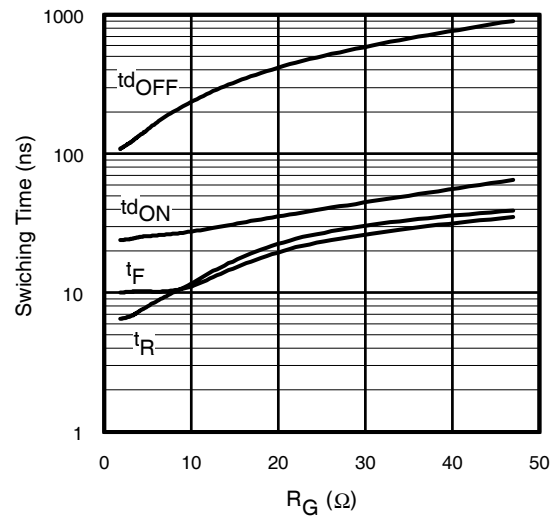
**Fig. 11 - Typ. Energy Loss vs.  $I_C$**   
 $T_J = 125^\circ C$ ;  $L = 200\mu H$ ;  $V_{CE} = 390V$ ;  $R_G = 3.3\Omega$ ;  $V_{GE} = 15V$ .  
Diode clamp used: 30ETH06 (See C.T.3)



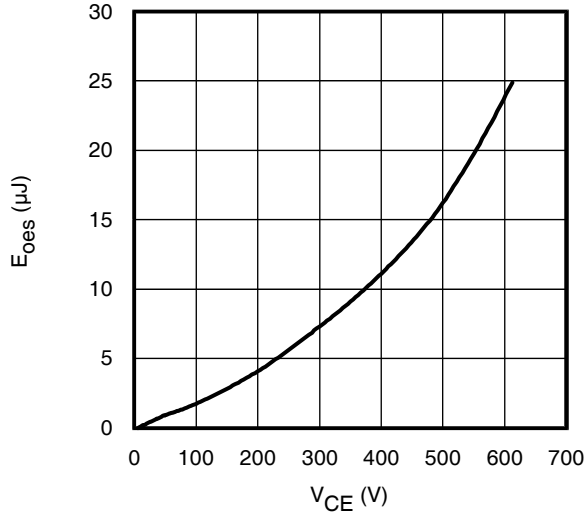
**Fig. 12 - Typ. Switching Time vs.  $I_C$**   
 $T_J = 125^\circ C$ ;  $L = 200\mu H$ ;  $V_{CE} = 390V$ ;  $R_G = 3.3\Omega$ ;  $V_{GE} = 15V$ .  
Diode clamp used: 30ETH06 (See C.T.3)



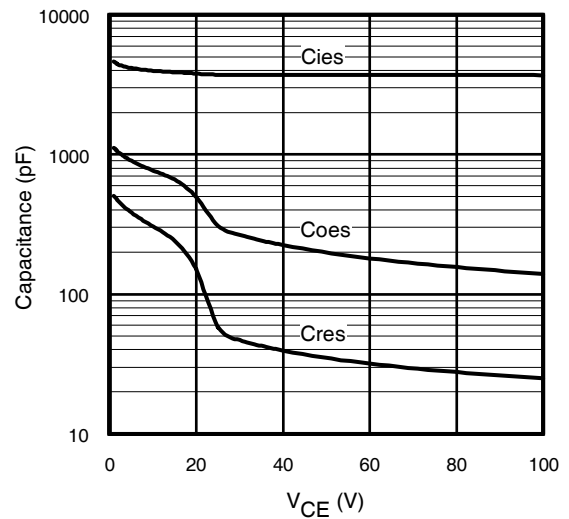
**Fig. 13 - Typ. Energy Loss vs.  $R_G$**   
 $T_J = 125^\circ\text{C}$ ;  $L = 200\mu\text{H}$ ;  $V_{CE} = 390\text{V}$ ;  $I_{CE} = 22\text{A}$ ;  $V_{GE} = 15\text{V}$   
 Diode clamp used: 30ETH06 (See C.T.3)



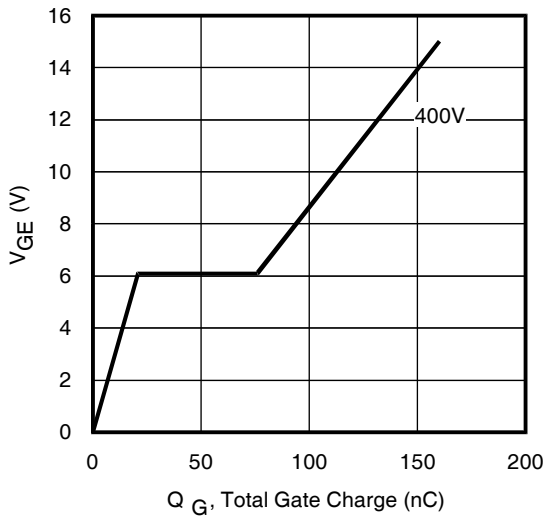
**Fig. 14 - Typ. Switching Time vs.  $R_G$**   
 $T_J = 125^\circ\text{C}$ ;  $L = 200\mu\text{H}$ ;  $V_{CE} = 390\text{V}$ ;  $I_{CE} = 22\text{A}$ ;  $V_{GE} = 15\text{V}$   
 Diode clamp used: 30ETH06 (See C.T.3)



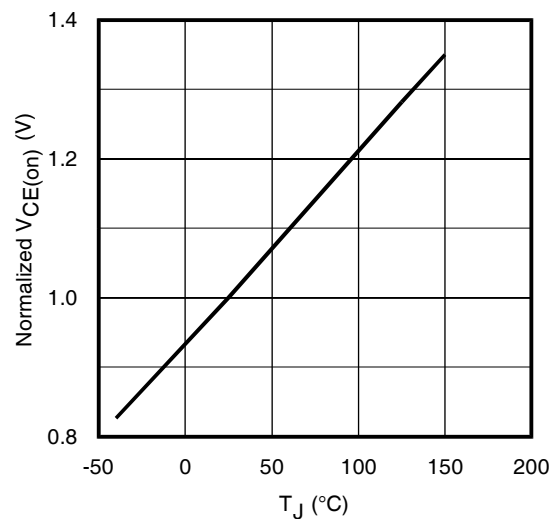
**Fig. 15- Typ. Output Capacitance  
 Stored Energy vs.  $V_{CE}$**



**Fig. 16- Typ. Capacitance vs.  $V_{CE}$**   
 $V_{GE} = 0\text{V}$ ;  $f = 1\text{MHz}$



**Fig. 17 - Typical Gate Charge vs.  $V_{GE}$**   
 $I_{CE} = 22\text{A}$



**Fig. 18 - Normalized Typ.  $V_{CE(on)}$   
 vs. Junction Temperature**  
 $I_C = 22\text{A}$ ,  $V_{GE} = 15\text{V}$

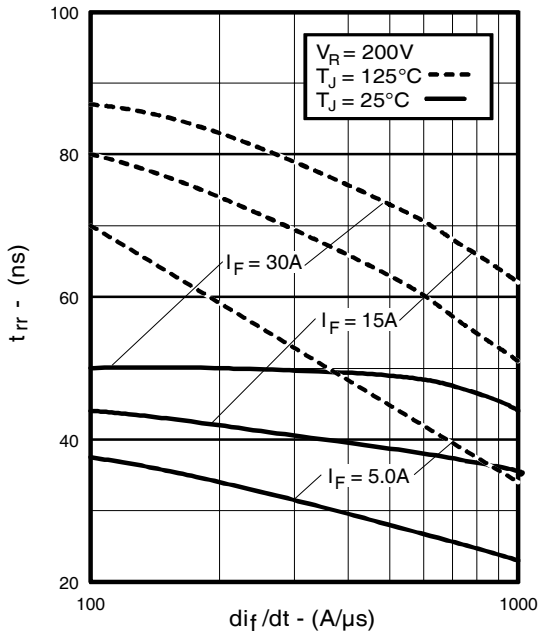


Fig. 19 - Typical Reverse Recovery vs.  $di_f/dt$

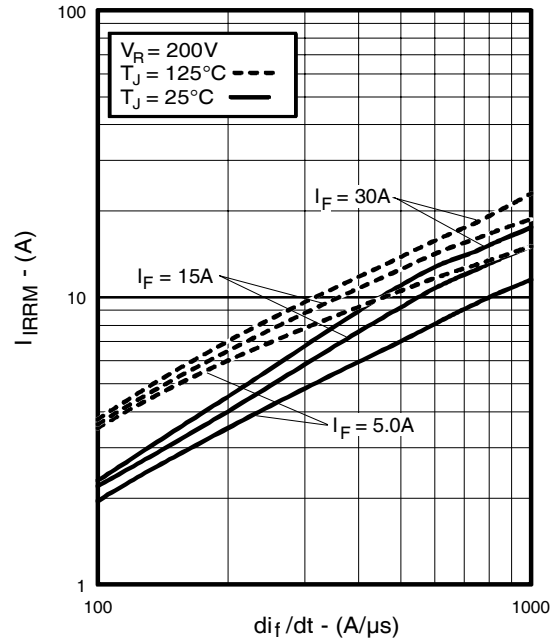


Fig. 20 - Typical Recovery Current vs.  $di_f/dt$

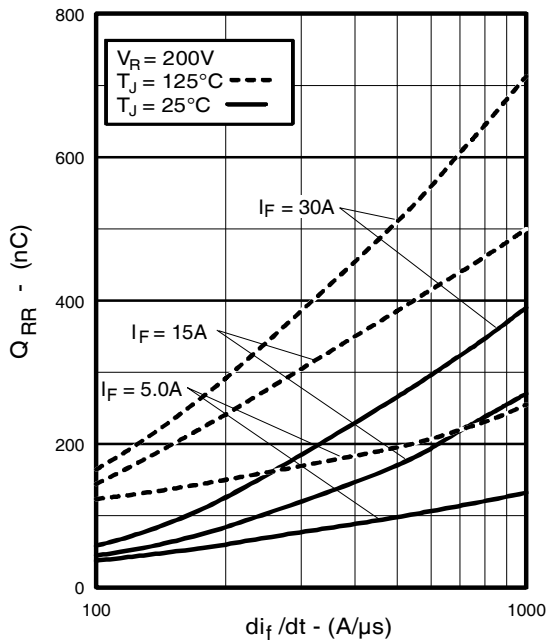


Fig. 21 - Typical Stored Charge vs.  $di_f/dt$

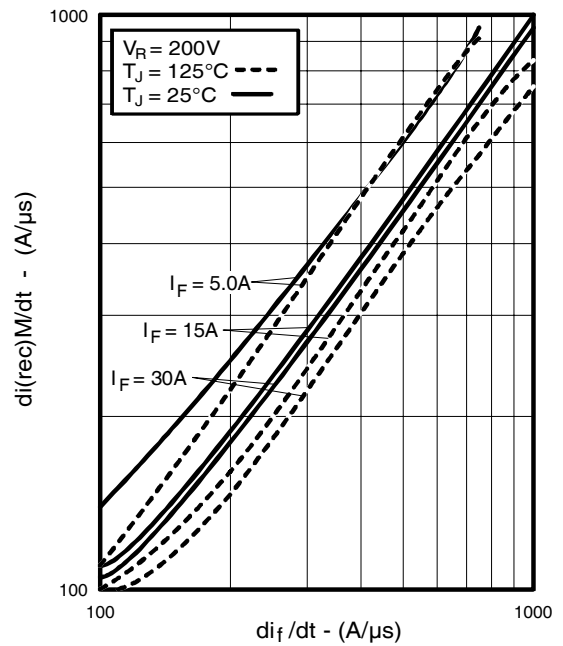


Fig. 22 - Typical  $di_{(rec)M}/dt$  vs.  $di_f/dt$

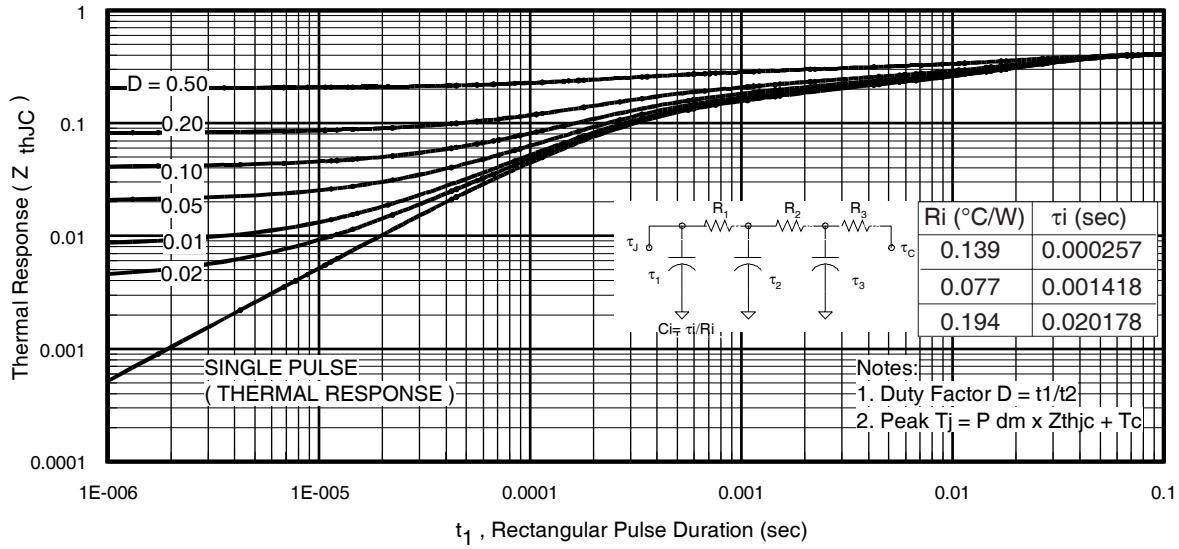


Fig 23. Maximum Transient Thermal Impedance, Junction-to-Case (IGBT)

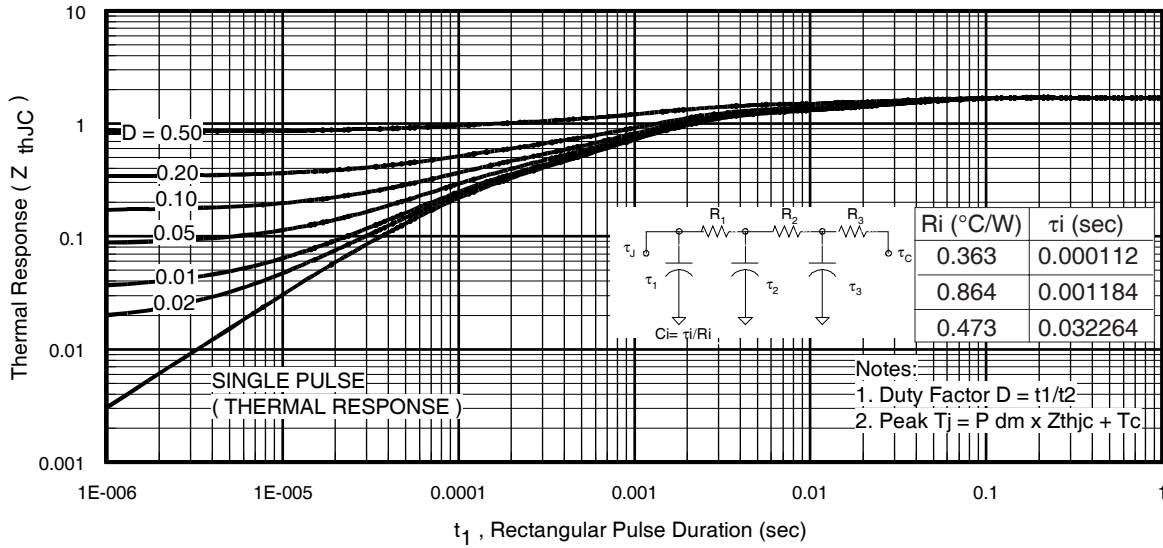
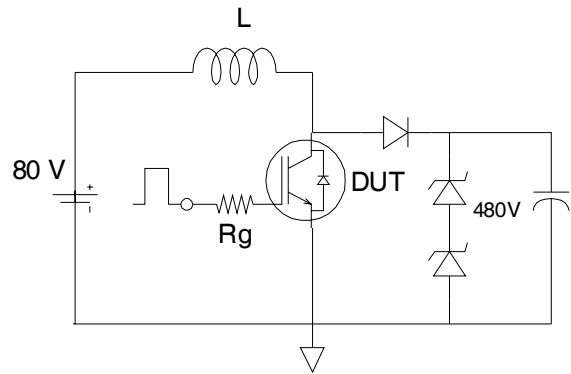


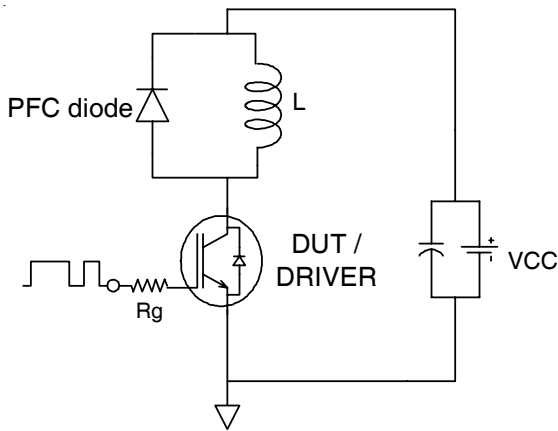
Fig. 24. Maximum Transient Thermal Impedance, Junction-to-Case (DIODE)



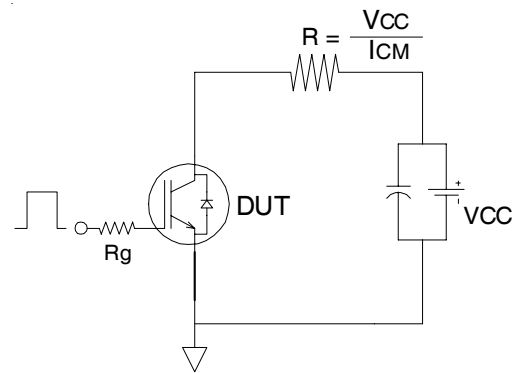
**Fig.C.T.1** - Gate Charge Circuit (turn-off)



**Fig.C.T.2** - RBSOA Circuit

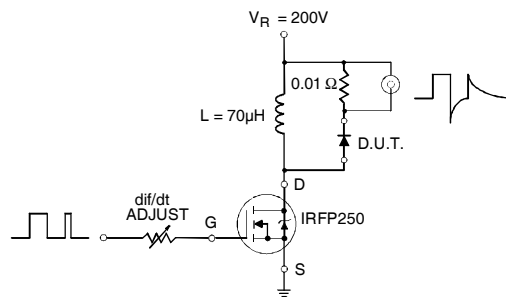


**Fig.C.T.3** - Switching Loss Circuit



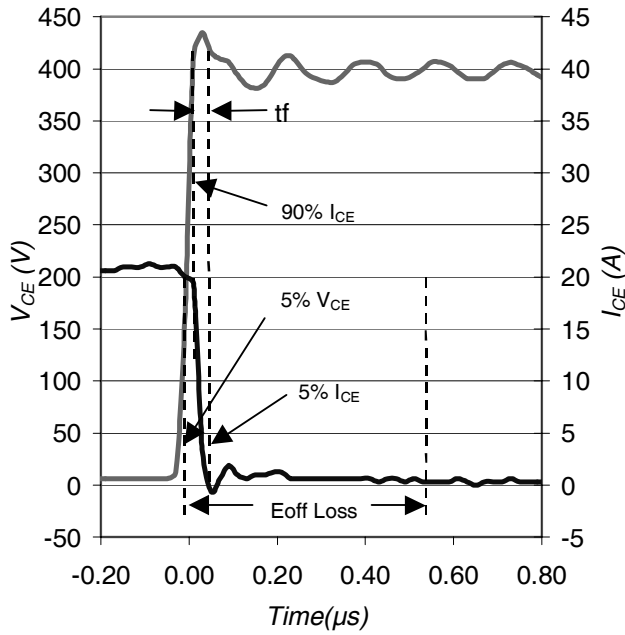
**Fig.C.T.4** - Resistive Load Circuit

### REVERSE RECOVERY CIRCUIT

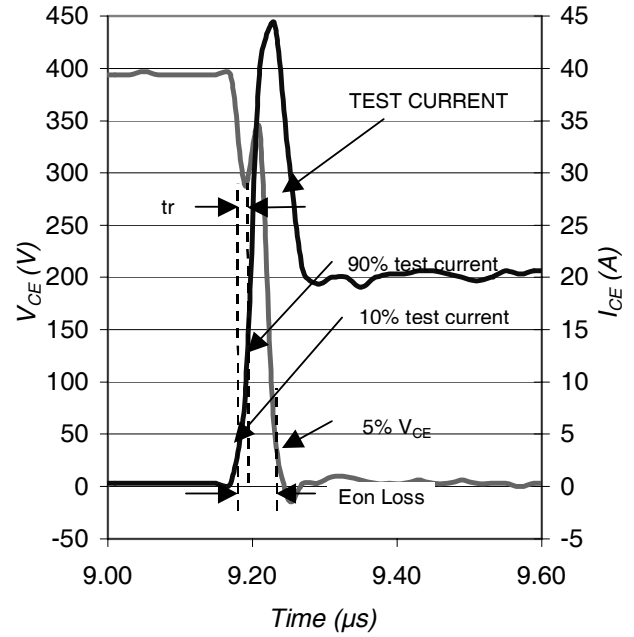


**Fig. C.T.5** - Reverse Recovery Parameter Test Circuit

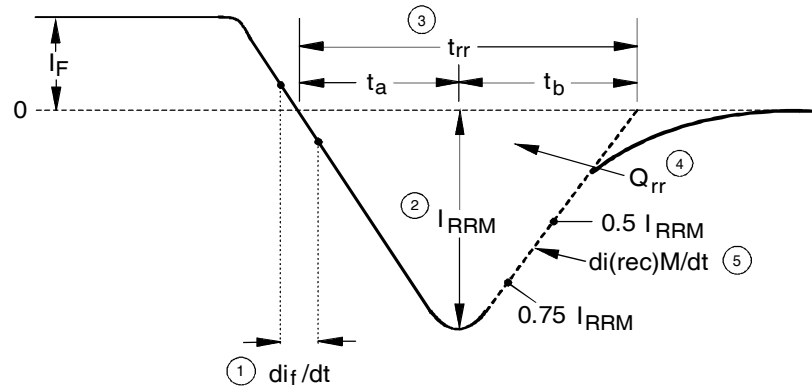




**Fig. WF1** - Typ. Turn-off Loss Waveform  
@  $T_J = 25^\circ\text{C}$  using Fig. CT.3



**Fig. WF2** - Typ. Turn-on Loss Waveform  
@  $T_J = 25^\circ\text{C}$  using Fig. CT.3



1.  $di_f/dt$  - Rate of change of current through zero crossing
2.  $I_{RRM}$  - Peak reverse recovery current
3.  $t_{rr}$  - Reverse recovery time measured from zero crossing point of negative going  $I_F$  to point where a line passing through  $0.75 I_{RRM}$  and  $0.50 I_{RRM}$  extrapolated to zero current

4.  $Q_{rr}$  - Area under curve defined by  $t_{rr}$  and  $I_{RRM}$

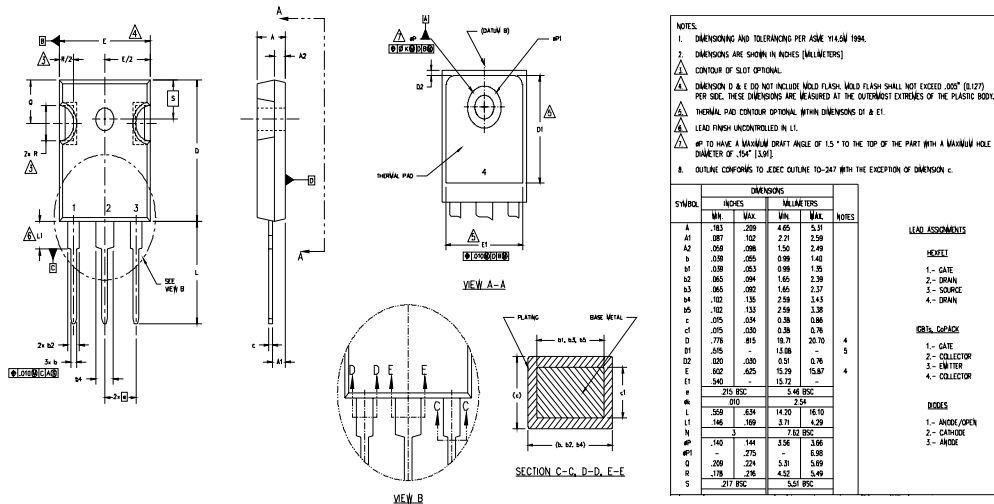
$$Q_{rr} = \frac{t_{rr} \times I_{RRM}}{2}$$

5.  $di_{(rec)M}/dt$  - Peak rate of change of current during  $t_b$  portion of  $t_{rr}$

**Fig. WF3** - Reverse Recovery Waveform and Definitions

## TO-247AC Package Outline

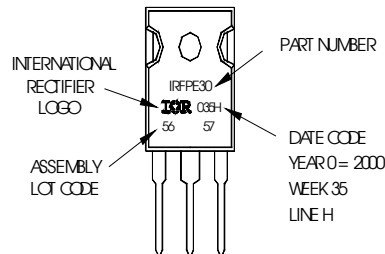
Dimensions are shown in millimeters (inches)



## TO-247AC Part Marking Information

EXAMPLE: THIS IS AN IRFP30  
WITH ASSEMBLY  
LOT CODE 5657  
ASSEMBLED ON VWV35 2000  
IN THE ASSEMBLY LINE "H"

**Note:** "P" in assembly line position indicates "Lead-Free"



TO-247AC package is not recommended for Surface Mount Application.

Data and specifications subject to change without notice.  
This product has been designed and qualified for Industrial market.  
Qualification Standards can be found on IR's Web site.

Note: For the most current drawings please refer to the IR website at:  
<http://www.irf.com/package/>

单击下面可查看定价，库存，交付和生命周期等信息

[>>Infineon Technologies\(英飞凌\)](#)