

Insulated Gate Bipolar Transistor with Ultrafast Soft Recovery Diode

$V_{CES} = 650V$
$I_C = 60A, T_C = 100^\circ C$
$t_{SC} \geq 5.5\mu s, T_{J(max)} = 175^\circ C$
$V_{CE(ON)} \text{ typ.} = 1.7V @ I_C = 48A$

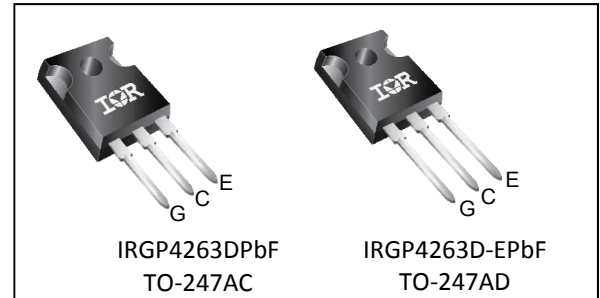
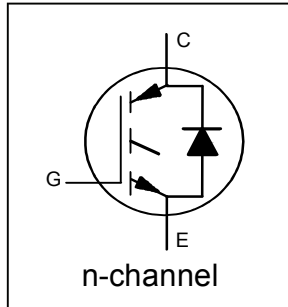

G	C	E
Gate	Collector	Emitter

Applications

- Industrial Motor Drive
- UPS
- Solar Inverters
- Welding

Features	Benefits
Low $V_{CE(ON)}$ and switching losses	High efficiency in a wide range of applications and switching frequencies
Square RBSOA and maximum junction temperature 175°C	Improved reliability due to rugged hard switching performance and higher power capability
Positive $V_{CE(ON)}$ temperature coefficient	
5.5µs short circuit SOA	Enables short circuit protection scheme
Lead-free, RoHS compliant	Environmentally friendly

Base part number	Package Type	Standard Pack		Orderable Part Number
		Form	Quantity	
IRGP4263DPbF	TO-247AC	Tube	25	IRGP4263DPbF
IRGP4263D-EPbF	TO-247AD	Tube	25	IRGP4263D-EPbF

Absolute Maximum Ratings

	Parameter	Max.	Units
V_{CES}	Collector-to-Emitter Voltage	650	V
$I_C @ T_C = 25^\circ C$	Continuous Collector Current	90	A
$I_C @ T_C = 100^\circ C$	Continuous Collector Current	60	
I_{CM}	Pulse Collector Current, $V_{GE}=20V$	192	
I_{LM}	Clamped Inductive Load Current, $V_{GE}=20V$ ①	192	
$I_F @ T_C = 25^\circ C$	Diode Continuous Forward Current	74	
$I_F @ T_C = 100^\circ C$	Diode Continuous Forward Current	45	
V_{GE}	Continuous Gate-to-Emitter Voltage	±20	V
$P_D @ T_C = 25^\circ C$	Maximum Power Dissipation	325	W
$P_D @ T_C = 100^\circ C$	Maximum Power Dissipation	160	
T_J T_{STG}	Operating Junction and Storage Temperature Range	-40 to +175	C
	Soldering Temperature, for 10 sec.	300 (0.063 in. (1.6mm) from case)	
	Mounting Torque, 6-32 or M3 Screw	10 lbf-in (1.1 N·m)	

Thermal Resistance

	Parameter	Min.	Typ.	Max.	Units
$R_{\theta JC}$ (IGBT)	Thermal Resistance Junction-to-Case-(each IGBT) ②	—	—	0.46	°C/W
$R_{\theta JC}$ (Diode)	Thermal Resistance Junction-to-Case-(each Diode) ②	—	—	0.97	
$R_{\theta CS}$	Thermal Resistance, Case-to-Sink (flat, greased surface)	—	0.24	—	
$R_{\theta JA}$	Thermal Resistance, Junction-to-Ambient (typical socket mount)	—	40	—	

Electrical Characteristics @ T_J = 25°C (unless otherwise specified)

	Parameter	Min.	Typ.	Max.	Units	Conditions
V _{(BR)CES}	Collector-to-Emitter Breakdown Voltage	650	—	—	V	V _{GE} = 0V, I _C = 100μA ③
ΔV _{(BR)CES} /ΔT _J	Temperature Coeff. of Breakdown Voltage	—	0.69	—	V/°C	V _{GE} = 0V, I _C = 3mA (25°C-175°C)
V _{CE(on)}	Collector-to-Emitter Saturation Voltage	—	1.7	2.1	V	I _C = 48A, V _{GE} = 15V, T _J = 25°C
		—	2.1	—		I _C = 48A, V _{GE} = 15V, T _J = 175°C
V _{GE(th)}	Gate Threshold Voltage	5.5	—	7.7	V	V _{CE} = V _{GE} , I _C = 1.4mA
ΔV _{GE(th)} /ΔT _J	Threshold Voltage Temperature Coeff.	—	-23	—	mV/°C	V _{CE} = V _{GE} , I _C = 1.4mA (25°C-150°C)
g _{fe}	Forward Transconductance	—	31	—	S	V _{CE} = 50V, I _C = 48A, PW = 20μs
I _{CES}	Collector-to-Emitter Leakage Current	—	1.0	35	μA	V _{GE} = 0V, V _{CE} = 650V
		—	890	—		V _{GE} = 0V, V _{CE} = 650V, T _J = 175°C
I _{GES}	Gate-to-Emitter Leakage Current	—	—	±100	nA	V _{GE} = ±20V
V _F	Diode Forward Voltage Drop	—	1.9	2.85	V	I _F = 48A
		—	1.4	—		I _F = 48A, T _J = 175°C

Switching Characteristics @ T_J = 25°C (unless otherwise specified)

	Parameter	Min.	Typ.	Max ^④	Units	Conditions
Q _g	Total Gate Charge (turn-on)	—	96	145	nC	I _C = 48A
Q _{ge}	Gate-to-Emitter Charge (turn-on)	—	30	45		V _{GE} = 15V
Q _{gc}	Gate-to-Collector Charge (turn-on)	—	40	60		V _{CC} = 400V
E _{on}	Turn-On Switching Loss	—	1.7	2.6	mJ	I _C = 48A, V _{CC} = 400V, V _{GE} = 15V R _G = 10Ω, L = 210μH, T _J = 25°C
E _{off}	Turn-Off Switching Loss	—	1.0	1.9		
E _{total}	Total Switching Loss	—	2.7	4.5		
t _{d(on)}	Turn-On delay time	—	70	90	ns	Energy losses include tail & diode reverse recovery ⑤⑥
t _r	Rise time	—	60	80		
t _{d(off)}	Turn-Off delay time	—	140	160		
t _f	Fall time	—	30	50		
E _{on}	Turn-On Switching Loss	—	2.9	—	mJ	I _C = 48A, V _{CC} = 400V, V _{GE} = 15V R _G = 10Ω, L = 210μH, T _J = 175°C
E _{off}	Turn-Off Switching Loss	—	1.4	—		
E _{total}	Total Switching Loss	—	4.3	—		
t _{d(on)}	Turn-On delay time	—	55	—	ns	Energy losses include tail & diode reverse recovery ⑤⑥
t _r	Rise time	—	60	—		
t _{d(off)}	Turn-Off delay time	—	145	—		
t _f	Fall time	—	65	—		
C _{ies}	Input Capacitance	—	2935	—	pF	V _{GE} = 0V V _{CC} = 30V f = 1.0MHz
C _{oes}	Output Capacitance	—	235	—		
C _{res}	Reverse Transfer Capacitance	—	84	—		
RBSOA	Reverse Bias Safe Operating Area	FULL SQUARE				T _J = 175°C, I _C = 144A V _{CC} = 480V, V _p ≤ 650V V _{GE} = +20V to 0V
SCSOA	Short Circuit Safe Operating Area	5.5	—	—	μs	T _J = 150°C, V _{CC} = 400V, V _p ≤ 650V V _{GE} = +15V to 0V
E _{rec}	Reverse Recovery Energy of the Diode	—	370	—	μJ	T _J = 175°C
t _{rr}	Diode Reverse Recovery Time	—	170	—	ns	V _{CC} = 400V, I _F = 48A
I _{rr}	Peak Reverse Recovery Current	—	25	—	A	V _{GE} = 15V, R _G = 10Ω

Notes:

- ① V_{CC} = 80% (V_{CES}), V_{GE} = 20V.
- ② R_θ is measured at T_J of approximately 90°C.
- ③ Refer to AN-1086 for guidelines for measuring V_{(BR)CES} safely.
- ④ Maximum limits are based on statistical sample size characterization.
- ⑤ Pulse width limited by max. junction temperature.
- ⑥ Values influenced by parasitic L and C in measurement.

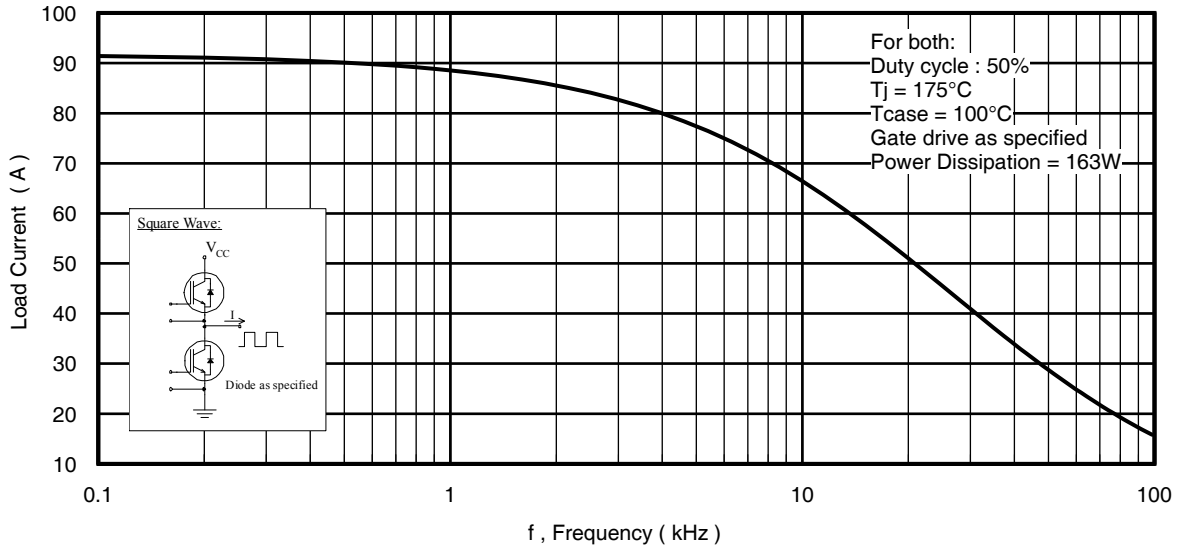

Fig. 1 - Typical Load Current vs. Frequency
(Load Current = I_{RMS} of fundamental)

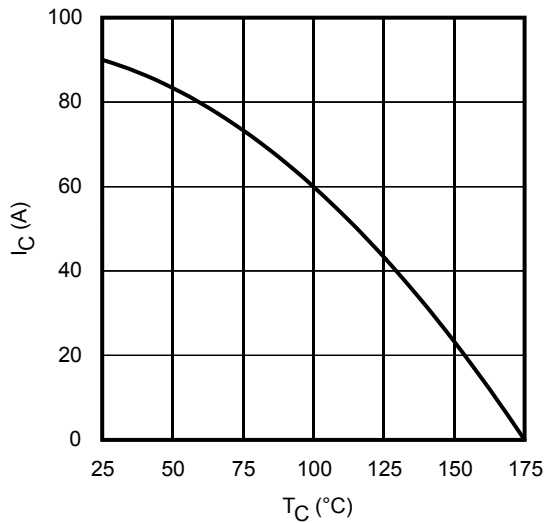

Fig. 2 - Maximum DC Collector Current vs. Case Temperature

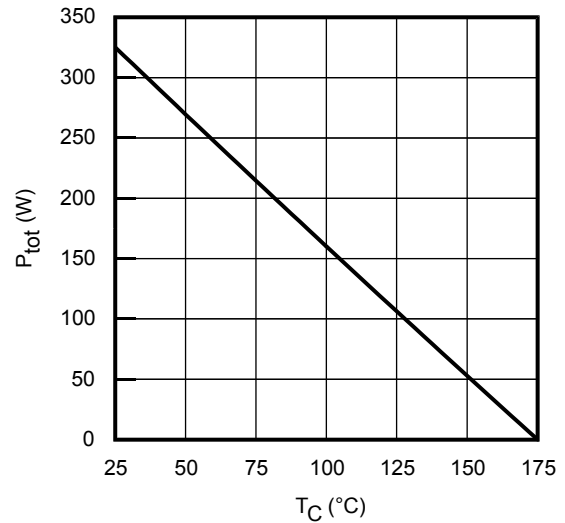

Fig. 3 - Power Dissipation vs. Case Temperature

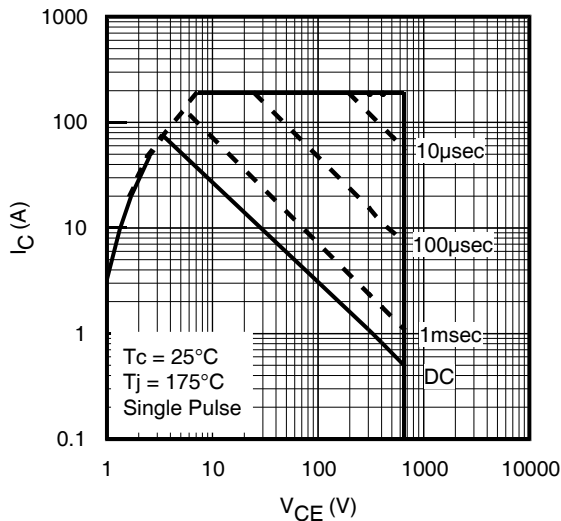

Fig. 4 - Forward SOA
 $T_C = 25^\circ\text{C}$; $T_J \leq 175^\circ\text{C}$; $V_{GE} = 15\text{V}$

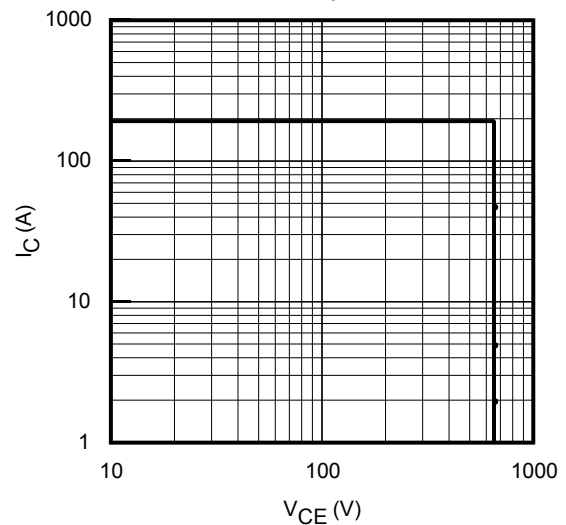

Fig. 5 - Reverse Bias SOA
 $T_J = 175^\circ\text{C}$; $V_{GE} = 20\text{V}$

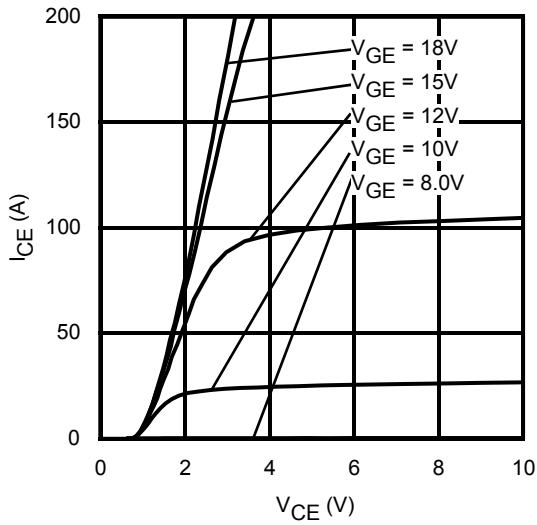

Fig. 6 - Typ. IGBT Output Characteristics
 $T_J = -40^\circ\text{C}$; $t_p = 20\mu\text{s}$

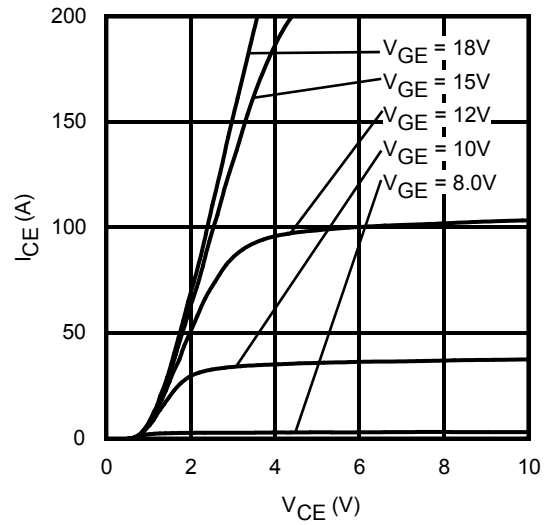

Fig. 7 - Typ. IGBT Output Characteristics
 $T_J = 25^\circ\text{C}$; $t_p = 20\mu\text{s}$

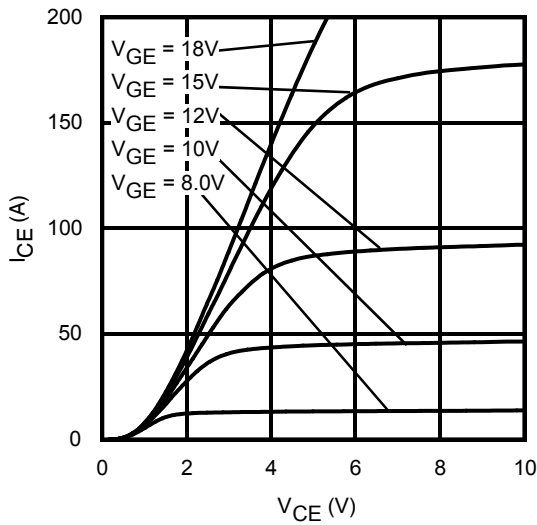

Fig. 8 - Typ. IGBT Output Characteristics
 $T_J = 175^\circ\text{C}$; $t_p = 20\mu\text{s}$

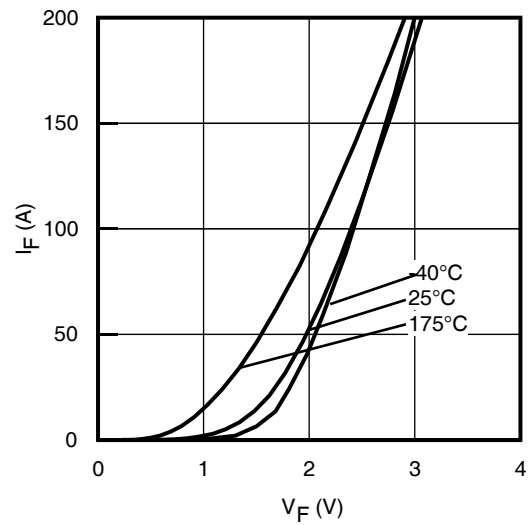

Fig. 9 - Typ. Diode Forward Voltage Drop Characteristics

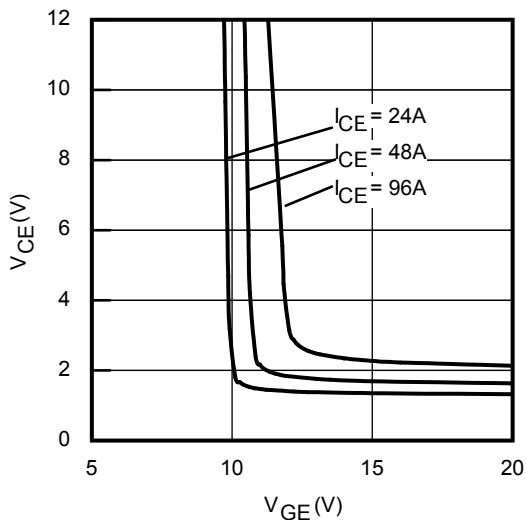

Fig. 10 - Typical V_{CE} vs. V_{GE}
 $T_J = -40^\circ\text{C}$

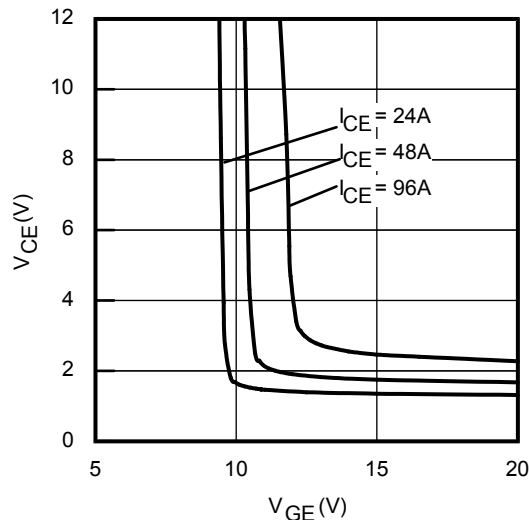

Fig. 11 - Typical V_{CE} vs. V_{GE}
 $T_J = 25^\circ\text{C}$

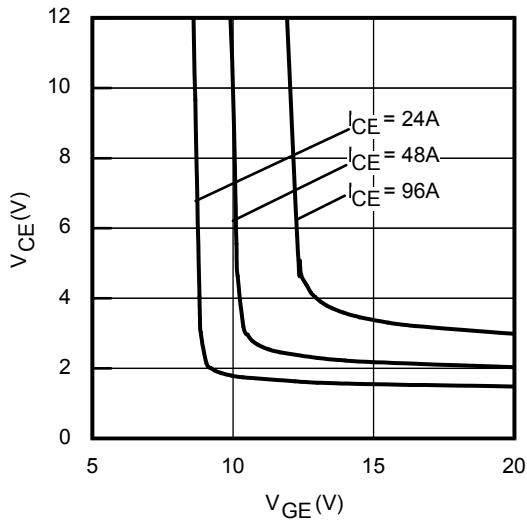

Fig. 12 - Typical V_{CE} vs. V_{GE}
 $T_J = 175^\circ\text{C}$

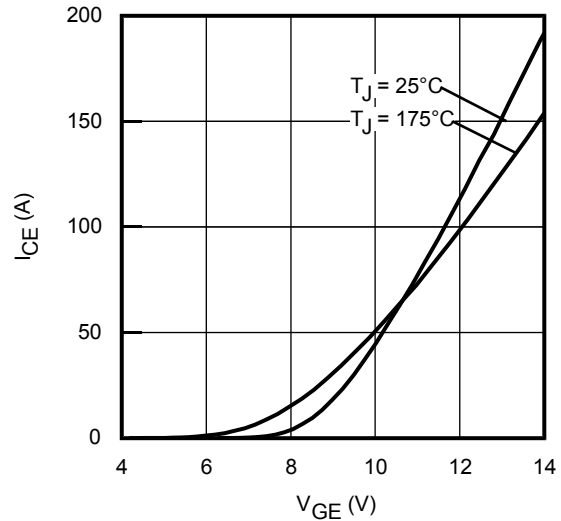

Fig. 13 - Typ. Transfer Characteristics
 $V_{CE} = 50\text{V}$; $t_p = 20\mu\text{s}$

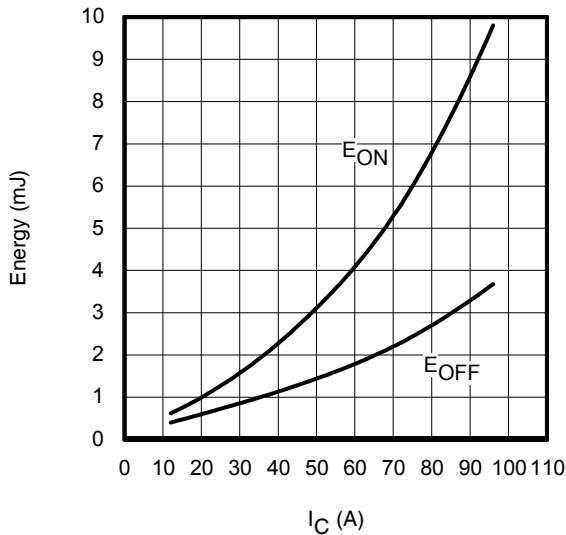

Fig. 14 - Typ. Energy Loss vs. I_C
 $T_J = 175^\circ\text{C}$; $L = 210\mu\text{H}$; $V_{CE} = 400\text{V}$; $R_G = 10\Omega$; $V_{GE} = 15\text{V}$

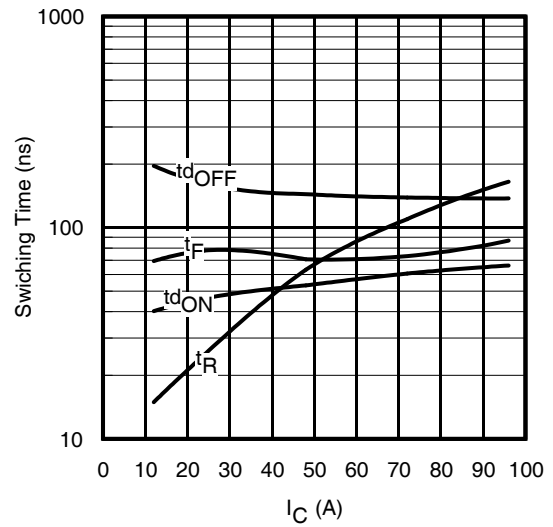

Fig. 15 - Typ. Switching Time vs. I_C
 $T_J = 175^\circ\text{C}$; $L = 210\mu\text{H}$; $V_{CE} = 400\text{V}$; $R_G = 10\Omega$; $V_{GE} = 15\text{V}$

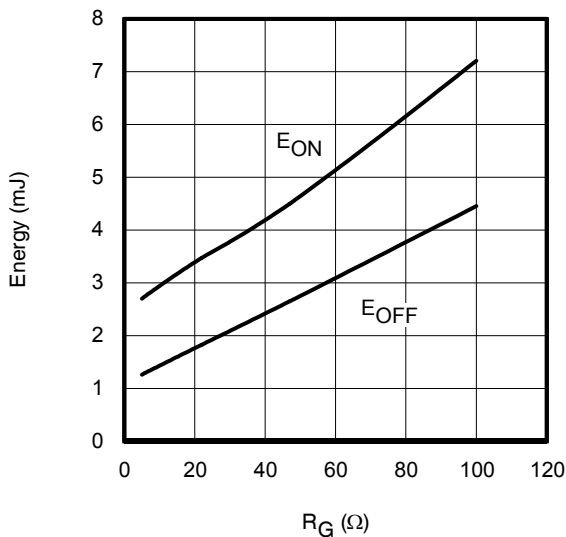

Fig. 16 - Typ. Energy Loss vs. R_G
 $T_J = 175^\circ\text{C}$; $L = 210\mu\text{H}$; $V_{CE} = 400\text{V}$; $I_{CE} = 48\text{A}$; $V_{GE} = 15\text{V}$

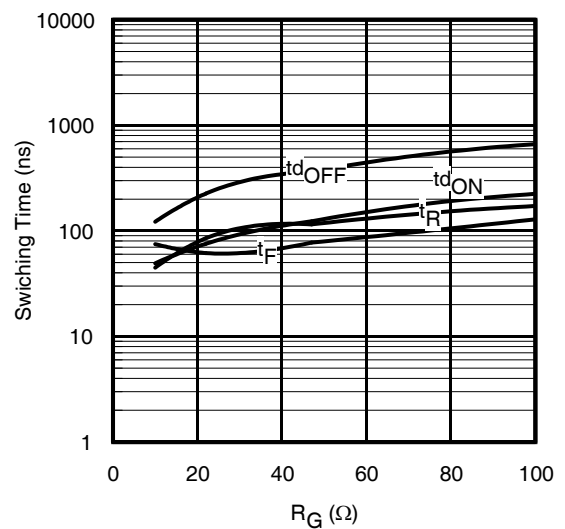

Fig. 17 - Typ. Switching Time vs. R_G
 $T_J = 175^\circ\text{C}$; $L = 210\mu\text{H}$; $V_{CE} = 400\text{V}$; $I_{CE} = 48\text{A}$; $V_{GE} = 15\text{V}$

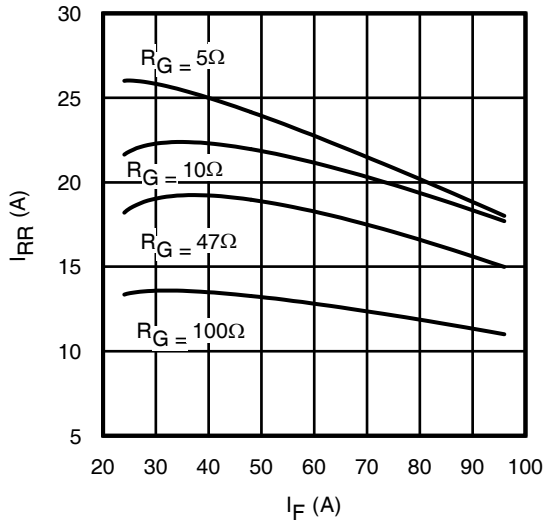

Fig. 18 - Typ. Diode I_{RR} vs. I_F
 $T_J = 175^\circ\text{C}$

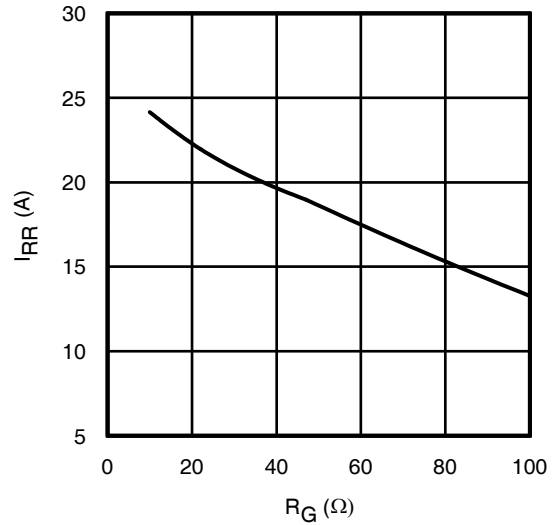

Fig. 19 - Typ. Diode I_{RR} vs. R_G
 $T_J = 175^\circ\text{C}$

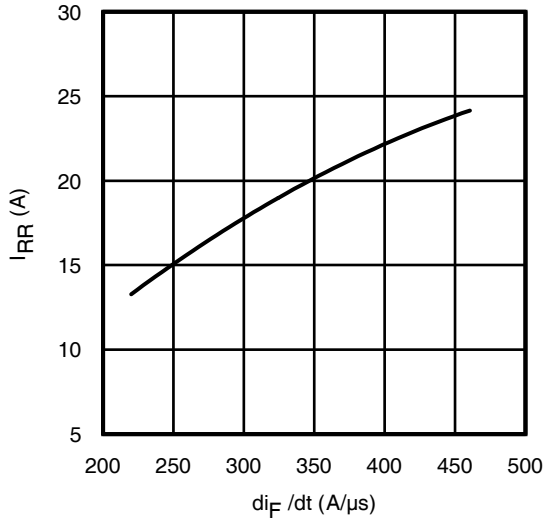

Fig. 20 - Typ. Diode I_{RR} vs. di_F/dt
 $V_{CC} = 400\text{V}$; $V_{GE} = 15\text{V}$; $I_F = 48\text{A}$; $T_J = 175^\circ\text{C}$

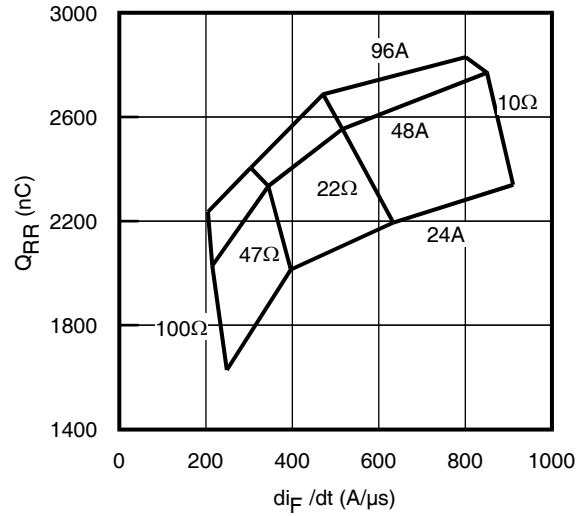

Fig. 21 - Typ. Diode Q_{RR} vs. di_F/dt
 $V_{CC} = 400\text{V}$; $V_{GE} = 15\text{V}$; $T_J = 175^\circ\text{C}$

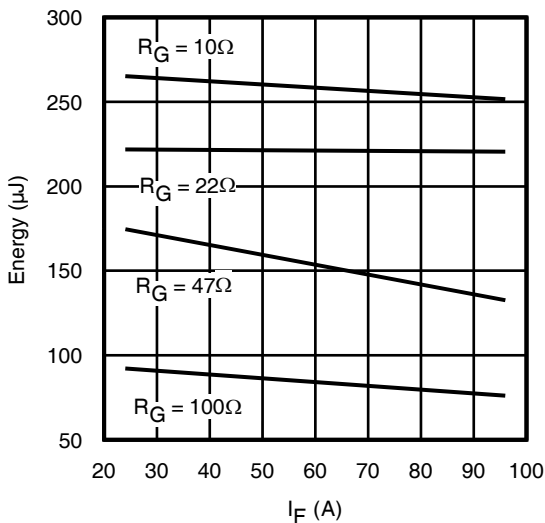

Fig. 22 - Typ. Diode E_{RR} vs. I_F
 $T_J = 175^\circ\text{C}$

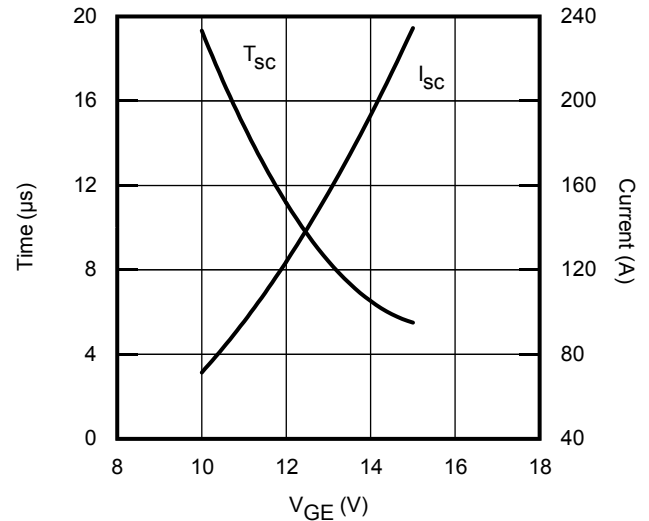

Fig. 23 - V_{GE} vs. Short Circuit Time
 $V_{CC} = 400\text{V}$; $T_C = 150^\circ\text{C}$

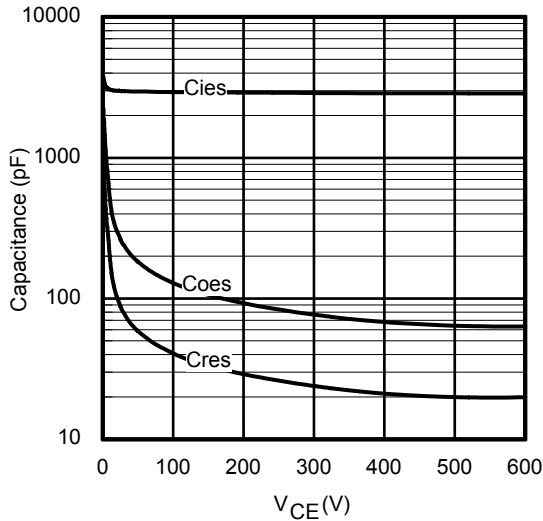

Fig. 24 - Typ. Capacitance vs. V_{CE}
 $V_{GE} = 0V$; $f = 1MHz$

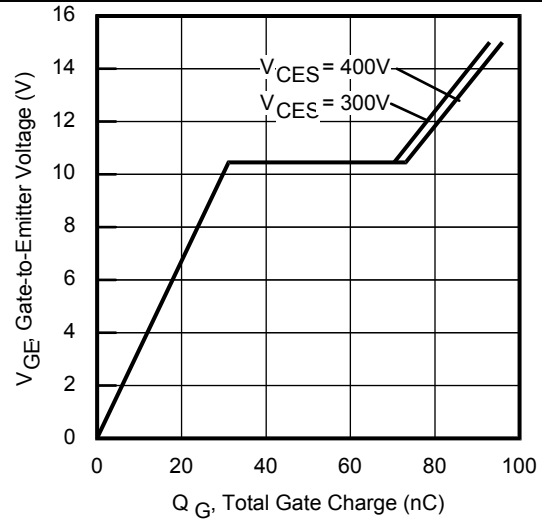

Fig. 25 - Typical Gate Charge vs. V_{GE}
 $I_{CE} = 48A$

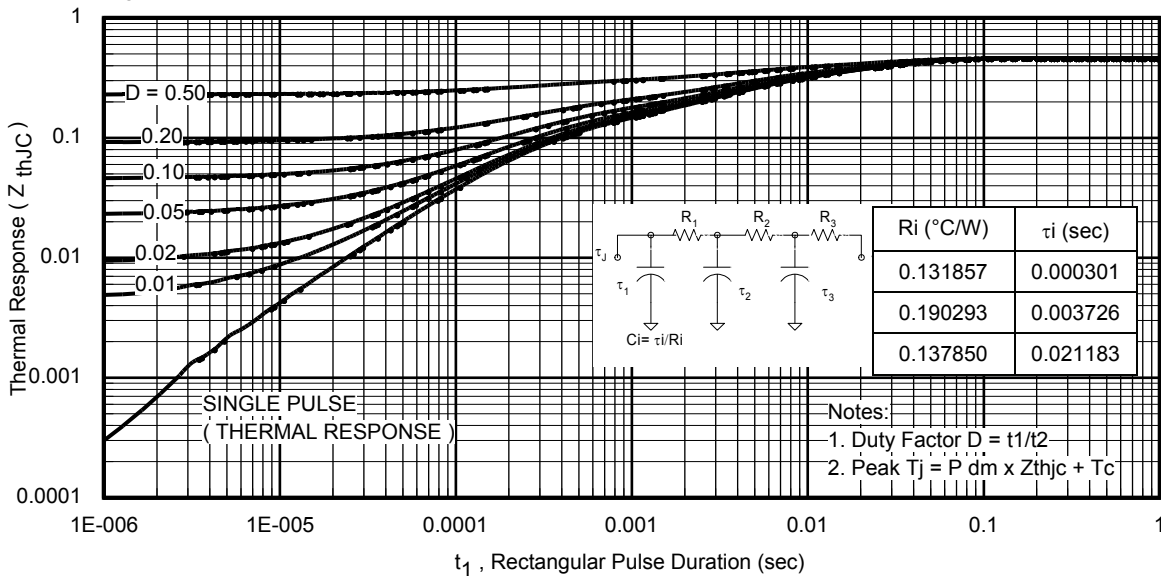

Fig. 26 - Maximum Transient Thermal Impedance, Junction-to-Case (IGBT)

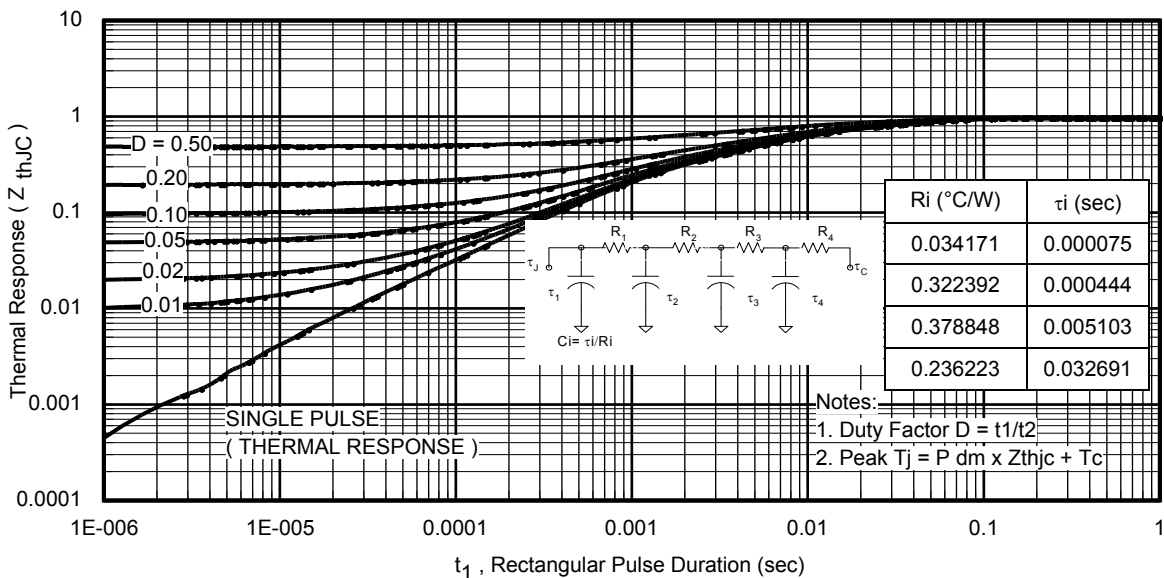

Fig. 27 - Maximum Transient Thermal Impedance, Junction-to-Case (DIODE)

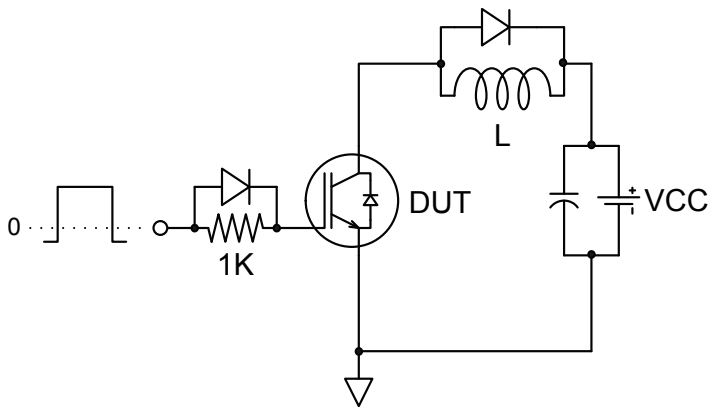

Fig.C.T.1 - Gate Charge Circuit (turn-off)

Fig.C.T.2 - RBSOA Circuit

Fig.C.T.3 - S.C. SOA Circuit

Fig.C.T.4 - Switching Loss Circuit

Fig.C.T.5 - Resistive Load Circuit

Fig.C.T.6 - BVCES Filter Circuit

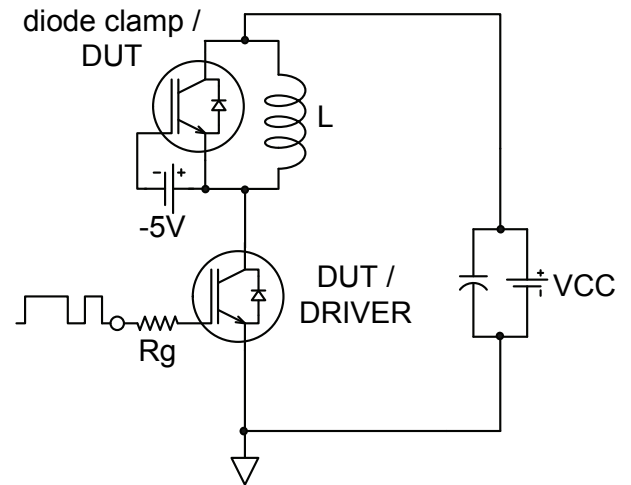
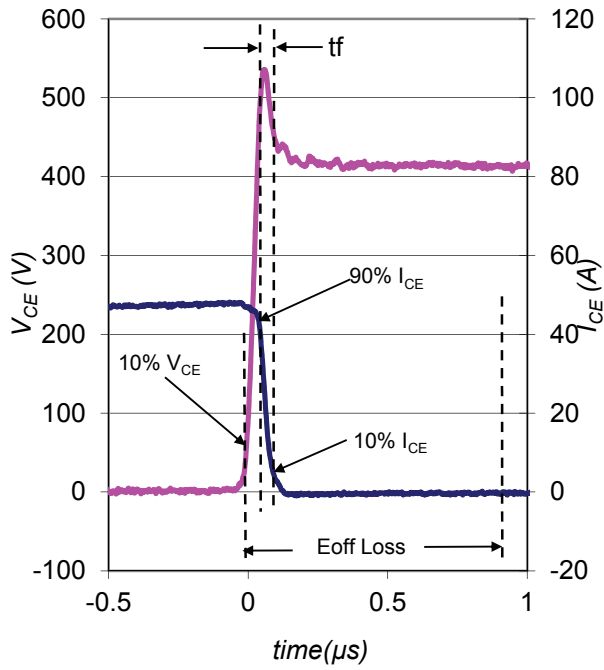

Fig. WF1 - Typ. Turn-off Loss Waveform
@ $T_J = 175^\circ\text{C}$ using Fig. CT.4

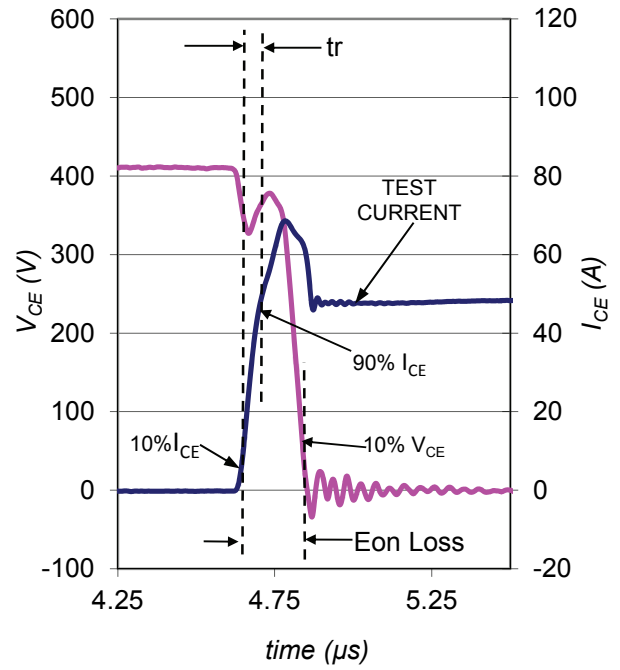

Fig. WF2 - Typ. Turn-on Loss Waveform
@ $T_J = 175^\circ\text{C}$ using Fig. CT.4

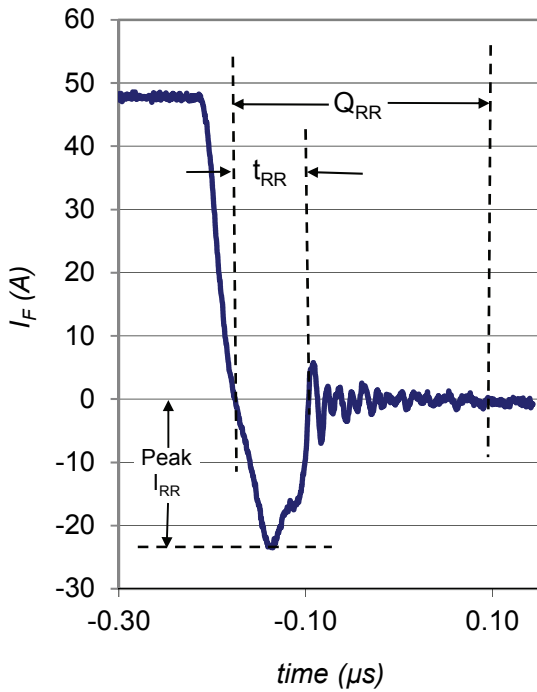

Fig. WF3 - Typ. Diode Recovery Waveform
@ $T_J = 175^\circ\text{C}$ using Fig. CT.4

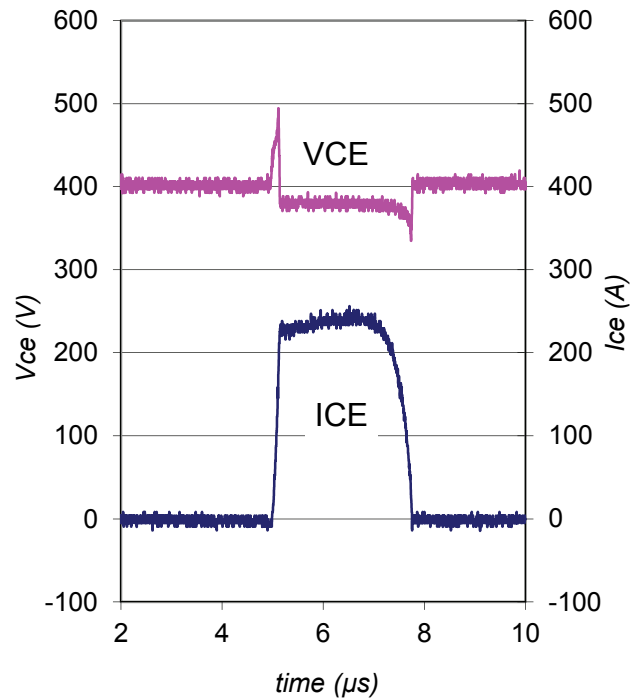
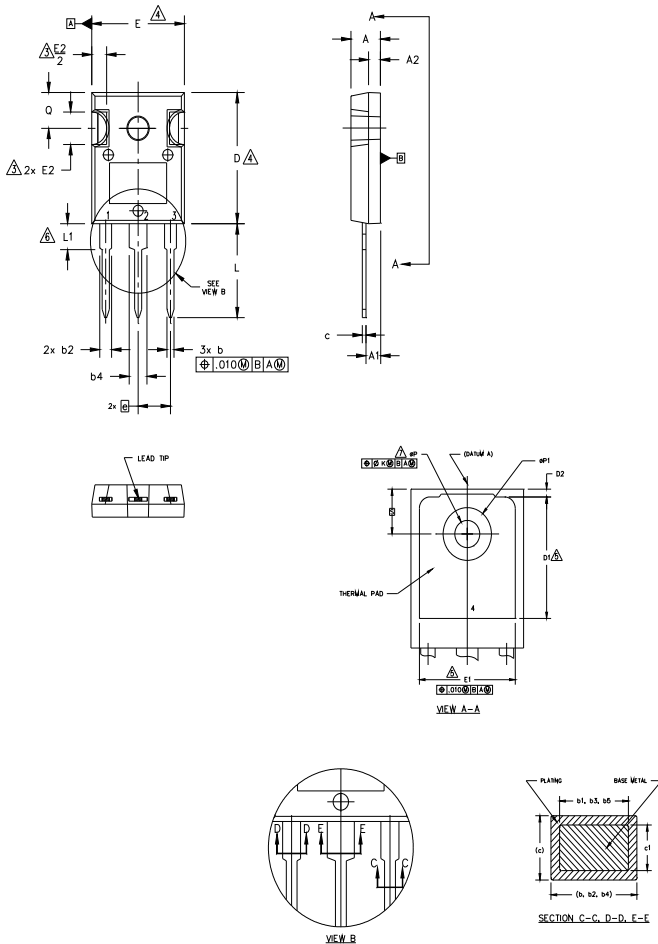

Fig. WF4 - Typ. S.C. Waveform
@ $T_J = 150^\circ\text{C}$ using Fig. CT.3

TO-247AC Package Outline

Dimensions are shown in millimeters (inches)



NOTES:

1. DIMENSIONING AND TOLERANCING AS PER ASME Y14.5M 1994.
2. DIMENSIONS ARE SHOWN IN INCHES.
3. CONTOUR OF SLOT OPTIONAL.
4. DIMENSION D & E DO NOT INCLUDE MOLD FLASH. MOLD FLASH SHALL NOT EXCEED .005" (0.127) PER SIDE. THESE DIMENSIONS ARE MEASURED AT THE OUTERMOST EXTREMES OF THE PLASTIC BODY.
5. THERMAL PAD CONTOUR OPTIONAL WITHIN DIMENSIONS D1 & E1.
6. LEAD FINISH UNCONTROLLED IN L1.
7. ØP TO HAVE A MAXIMUM DRAFT ANGLE OF 1.5 ° TO THE TOP OF THE PART WITH A MAXIMUM HOLE DIAMETER OF .154 INCH.
8. OUTLINE CONFORMS TO JEDEC OUTLINE TO-247AC .

SYMBOL	DIMENSIONS				NOTES
	INCHES		MILLIMETERS		
	MIN.	MAX.	MIN.	MAX.	
A	.183	.209	4.65	5.31	
A1	.087	.102	2.21	2.59	
A2	.059	.098	1.50	2.49	
b	.039	.055	0.99	1.40	
b1	.039	.053	0.99	1.35	
b2	.065	.094	1.65	2.39	
b3	.065	.092	1.65	2.34	
b4	.102	.135	2.59	3.43	
b5	.102	.133	2.59	3.38	
c	.015	.035	0.38	0.89	
c1	.015	.033	0.38	0.84	
D	.776	.815	19.71	20.70	4
D1	.515	-	13.08	-	5
D2	.020	.053	0.51	1.35	
E	.602	.625	15.29	15.87	4
E1	.530	-	13.46	-	
E2	.178	.216	4.52	5.49	
e	.215 BSC		5.46 BSC		
Øk	.010		0.25		
L	.559	.634	14.20	16.10	
L1	.146	.169	3.71	4.29	
ØP	.140	.144	3.56	3.66	
ØP1	-	.291	-	7.39	
Q	.209	.224	5.31	5.69	
S	.217 BSC		5.51 BSC		

LEAD ASSIGNMENTS

HEXFET

- 1.- GATE
- 2.- DRAIN
- 3.- SOURCE
- 4.- DRAIN

IGBTs, CoPACK

- 1.- GATE
- 2.- COLLECTOR
- 3.- EMITTER
- 4.- COLLECTOR

DIODES

- 1.- ANODE/OPEN
- 2.- CATHODE
- 3.- ANODE

TO-247AC Part Marking Information

Notes: This part marking information applies to devices produced after 02/26/2001

EXAMPLE: THIS IS AN IRFPE30
WITH ASSEMBLY
LOT CODE 5657
ASSEMBLED ON WW 35, 2001
IN THE ASSEMBLY LINE "H"

Note: "P" in assembly line position indicates "Lead-Free"

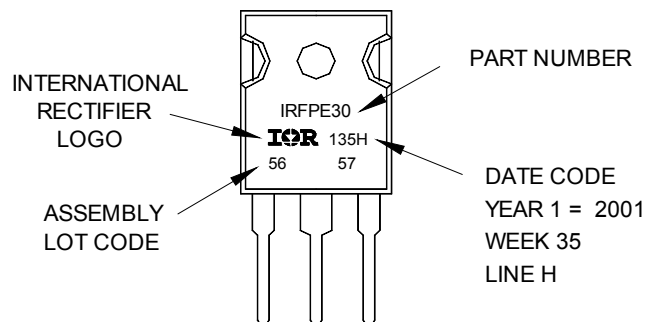

TO-247AC package is not recommended for Surface Mount Application.

Note: For the most current drawing please refer to IR website at <http://www.irf.com/package/>

TO-247AD Package Outline

Dimensions are shown in millimeters (inches)

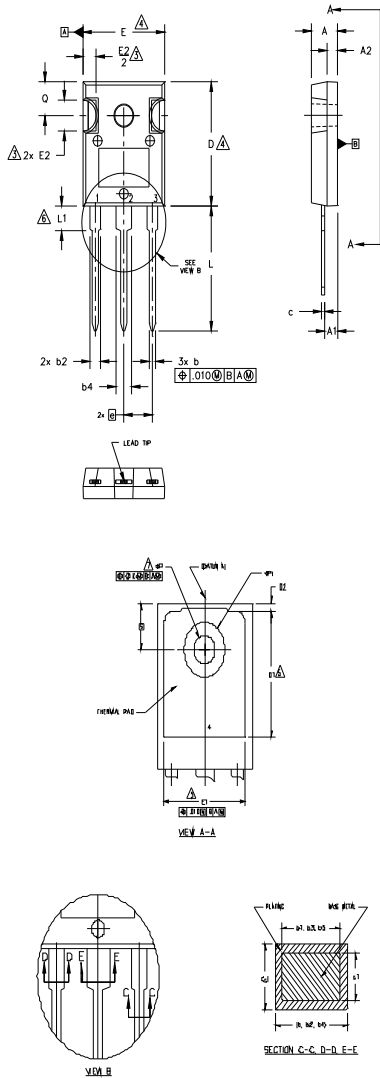

NOTES:

1. DIMENSIONING AND TOLERANCING AS PER ASME Y14.5M 1994.
2. DIMENSIONS ARE SHOWN IN INCHES.
3. CONTOUR OF SLOT OPTIONAL.
4. DIMENSION D & E DO NOT INCLUDE MOLD FLASH. MOLD FLASH SHALL NOT EXCEED .005" (0.127) PER SIDE. THESE DIMENSIONS ARE MEASURED AT THE OUTERMOST EXTREMES OF THE PLASTIC BODY.
5. THERMAL PAD CONTOUR OPTIONAL WITHIN DIMENSIONS D1 & E1.
6. LEAD FINISH UNCONTROLLED IN L1.
7. ØP TO HAVE A MAXIMUM DRAFT ANGLE OF 1.5° TO THE TOP OF THE PART WITH A MAXIMUM HOLE DIAMETER OF .154 INCH.
8. OUTLINE CONFORMS TO JEDEC OUTLINE TO-247AD.

SYMBOL	DIMENSIONS				NOTES
	INCHES		MILLIMETERS		
	MIN.	MAX.	MIN.	MAX.	
A	.183	.209	4.65	5.31	
A1	.087	.102	2.21	2.59	
A2	.059	.098	1.50	2.49	
b	0.39	.056	0.99	1.40	
b1	.039	.053	0.99	1.36	
b2	.065	.094	1.65	2.39	
b3	.065	.092	1.65	2.34	
b4	.102	.135	2.59	3.43	
b5	.102	.133	2.59	3.38	
c	.015	.036	0.38	0.89	
c1	.015	.033	0.38	0.84	
D	.776	.815	19.71	20.70	4
D1	.515	-	13.08	-	5
D2	.020	.053	0.51	1.36	
E	.602	.625	15.29	15.87	4
E1	.530	-	13.46	-	
E2	.178	.216	4.52	5.49	
e	.215 BSC		5.46 BSC		
Øk	.010		0.25		
L	.780	.827	19.57	21.00	
L1	.146	.169	3.71	4.29	
ØP	.140	.144	3.56	3.66	
Q	-	.291	-	7.39	
S	.209		5.31		
	.217 BSC		5.51 BSC		

LEAD ASSIGNMENTS

HEXFET

- 1.- GATE
- 2.- DRAIN
- 3.- SOURCE
- 4.- DRAIN

IGBTs, CoPACK

- 1.- GATE
- 2.- COLLECTOR
- 3.- EMITTER
- 4.- COLLECTOR

DIODES

- 1.- ANODE/OPEN
- 2.- CATHODE
- 3.- ANODE

TO-247AD Part Marking Information

EXAMPLE: THIS IS AN IRGP30B120KD-E
WITH ASSEMBLY
LOT CODE 5657
ASSEMBLED ON WW 35, 2000
IN THE ASSEMBLY LINE "H"

Note: "P" in assembly line position
indicates "Lead-Free"

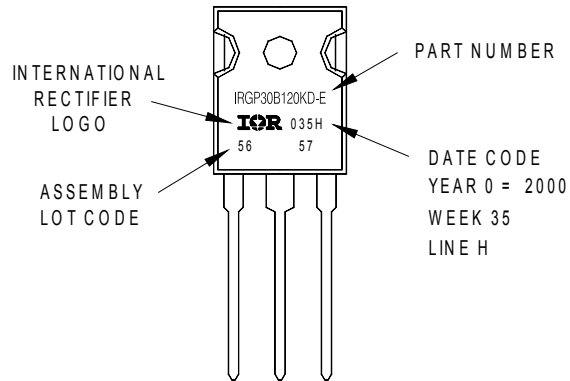

TO-247AD package is not recommended for Surface Mount Application.

Note: For the most current drawing please refer to IR website at <http://www.irf.com/package/>

Qualification Information[†]

Qualification Level	Industrial (per JEDEC JESD47F) ^{††}	
Moisture Sensitivity Level	TO-247AC	N/A
	TO-247AD	N/A
RoHS Compliant	Yes	

† Qualification standards can be found at International Rectifier's web site: <http://www.irf.com/product-info/reliability/>

†† Applicable version of JEDEC standard at the time of product release.

Revision History

Date	Comments
8/21/2014	• Updated I_C vs. T_C graph Fig.2 to match page1 spec data on page 3.
	• Updated package outline on page 11.

单击下面可查看定价，库存，交付和生命周期等信息

[>>Infineon Technologies\(英飞凌\)](#)