

DirectFET™ Power MOSFET ②
Typical values (unless otherwise specified)

- RoHS Compliant and Halogen Free ①
- Low Profile (<0.7 mm)
- Dual Sided Cooling Compatible ①
- Ultra Low Package Inductance
- Optimized for High Frequency Switching ①
- Ideal for CPU Core DC-DC Converters
- Optimized for both Sync.FET and some Control FET application ①
- Low Conduction and Switching Losses
- Compatible with existing Surface Mount Techniques ①
- 100% Rg tested

| V_{DS} | | V_{GS} | | $R_{DS(on)}$ | |
|--------------|----------|-----------|----------|--------------|--------------|
| 25V max | | ±20V max | | 3.8mΩ @ 10V | |
| | | | | 6.7mΩ @ 4.5V | |
| $Q_{g\ tot}$ | Q_{gd} | Q_{gs2} | Q_{rr} | Q_{oss} | $V_{gs(th)}$ |
| 12nC | 4.0nC | 1.7nC | 14nC | 10nC | 1.9V |

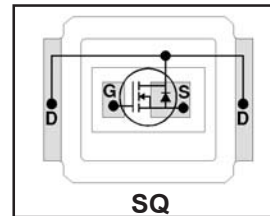

Applicable DirectFET Outline and Substrate Outline (see p.7,8 for details) ①

| | | | | | | | | | | |
|----|----|----|--|----|----|----|----|--|--|--|
| SQ | SX | ST | | MQ | MX | MT | MP | | | |
|----|----|----|--|----|----|----|----|--|--|--|

Description

The IRF6712SPbF combines the latest HEXFET® Power MOSFET Silicon technology with the advanced DirectFET™ packaging to achieve the lowest on-state resistance in a package that has the footprint of a MICRO-8 and only 0.7 mm profile. The DirectFET package is compatible with existing layout geometries used in power applications, PCB assembly equipment and vapor phase, infra-red or convection soldering techniques, when application note AN-1035 is followed regarding the manufacturing methods and processes. The DirectFET package allows dual sided cooling to maximize thermal transfer in power systems, improving previous best thermal resistance by 80%.

The IRF6712SPbF balances both low resistance and low charge along with ultra low package inductance to reduce both conduction and switching losses. The reduced total losses make this product ideal for high efficiency DC-DC converters that power the latest generation of processors operating at higher frequencies. The IRF6712SPbF has been optimized for parameters that are critical in synchronous buck operating from 12 volt bus converters including Rds(on) and gate charge to minimize losses.

| Base Part Number | Package Type | Standard Pack | | Orderable Part Number □ |
|------------------|---------------------|---------------|----------|----------------------------|
| | | Form | Quantity | |
| IRF6712SPbF | DirectFET Small Can | Tape and Reel | 4800 | IRF6712STRPbF |
| | | Tape and Reel | 1000 | IRF6712STR1PbF |

Absolute Maximum Ratings

| | Parameter | Max. | Units |
|--------------------------|--|------|-------|
| V_{DS} | Drain-to-Source Voltage | 25 | V |
| V_{GS} | Gate-to-Source Voltage | ±20 | |
| $I_D @ T_A = 25^\circ C$ | Continuous Drain Current, $V_{GS} @ 10V$ ③ | 17 | A |
| $I_D @ T_A = 70^\circ C$ | Continuous Drain Current, $V_{GS} @ 10V$ ③ | 13 | |
| $I_D @ T_C = 25^\circ C$ | Continuous Drain Current, $V_{GS} @ 10V$ ④ | 68 | |
| I_{DM} | Pulsed Drain Current ⑤ | 130 | |
| E_{AS} | Single Pulse Avalanche Energy ⑥ | 13 | mJ |
| I_{AR} | Avalanche Current ⑤ | 13 | A |

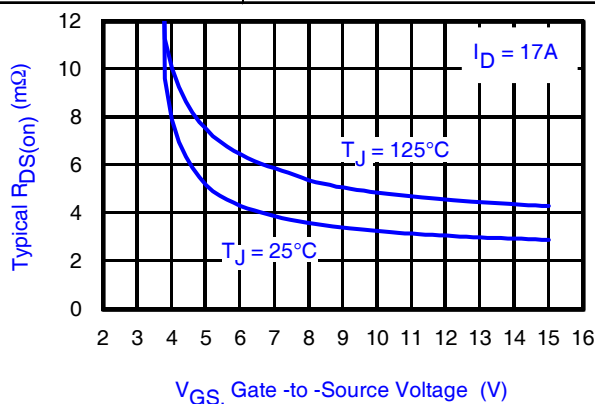

Fig 1. Typical On-Resistance Vs. Gate Voltage

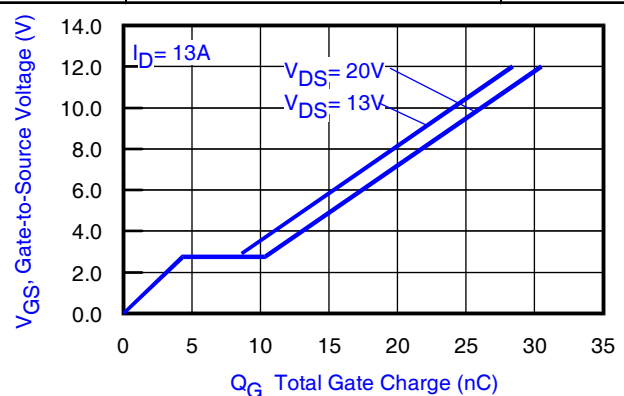

Fig 2. Typical Total Gate Charge vs Gate-to-Source Voltage

Notes:

- ① Click on this section to link to the appropriate technical paper.
- ② Click on this section to link to the DirectFET Website.
- ③ Surface mounted on 1 in. square Cu board, steady state.
- ④ T_C measured with thermocouple mounted to top (Drain) of part.
- ⑤ Repetitive rating; pulse width limited by max. junction temperature.
- ⑥ Starting $T_J = 25^\circ C$, $L = 0.14mH$, $R_G = 25\Omega$, $I_{AS} = 13A$.

Static @ $T_J = 25^\circ\text{C}$ (unless otherwise specified)

| | Parameter | Min. | Typ. | Max. | Units | Conditions |
|--------------------------------|--|------|------|------|-------|--|
| BV_{DSS} | Drain-to-Source Breakdown Voltage | 25 | — | — | V | $V_{GS} = 0V, I_D = 250\mu A$ |
| $\Delta BV_{DSS}/\Delta T_J$ | Breakdown Voltage Temp. Coefficient | — | 18 | — | mV/°C | Reference to $25^\circ\text{C}, I_D = 1\text{mA}$ |
| $R_{DS(on)}$ | Static Drain-to-Source On-Resistance | — | 3.8 | 4.9 | mΩ | $V_{GS} = 10V, I_D = 17A$ ⑦ |
| | | — | 6.7 | 8.7 | | $V_{GS} = 4.5V, I_D = 13A$ ⑦ |
| $V_{GS(th)}$ | Gate Threshold Voltage | 1.4 | 1.9 | 2.4 | V | $V_{DS} = V_{GS}, I_D = 50\mu A$ |
| $\Delta V_{GS(th)}/\Delta T_J$ | Gate Threshold Voltage Coefficient | — | -6.1 | — | mV/°C | |
| I_{DSS} | Drain-to-Source Leakage Current | — | — | 1.0 | μA | $V_{DS} = 25V, V_{GS} = 0V$ |
| | | — | — | 150 | | $V_{DS} = 25V, V_{GS} = 0V, T_J = 125^\circ\text{C}$ |
| I_{GSS} | Gate-to-Source Forward Leakage | — | — | 100 | nA | $V_{GS} = 20V$ |
| | Gate-to-Source Reverse Leakage | — | — | -100 | | $V_{GS} = -20V$ |
| g_{fs} | Forward Transconductance | 40 | — | — | S | $V_{DS} = 13V, I_D = 13A$ |
| Q_g | Total Gate Charge | — | 12 | 18 | nC | $V_{DS} = 13V$ $V_{GS} = 4.5V$ $I_D = 13A$ See Fig. 15 |
| Q_{gs1} | Pre-V _{th} Gate-to-Source Charge | — | 2.9 | — | | |
| Q_{gs2} | Post-V _{th} Gate-to-Source Charge | — | 1.7 | — | | |
| Q_{gd} | Gate-to-Drain Charge | — | 4.0 | — | | |
| Q_{godr} | Gate Charge Overdrive | — | 3.5 | — | | |
| Q_{sw} | Switch Charge ($Q_{gs2} + Q_{gd}$) | — | 5.8 | — | | |
| Q_{oss} | Output Charge | — | 10 | — | nC | $V_{DS} = 16V, V_{GS} = 0V$ |
| R_G | Gate Resistance | — | 1.7 | 3.0 | Ω | |
| $t_{d(on)}$ | Turn-On Delay Time | — | 11 | — | ns | $V_{DD} = 13V, V_{GS} = 4.5V$ ⑦ $I_D = 13A$ $R_G = 1.8\Omega$ See Fig. 17 |
| t_r | Rise Time | — | 40 | — | | |
| $t_{d(off)}$ | Turn-Off Delay Time | — | 14 | — | | |
| t_f | Fall Time | — | 12 | — | | |
| C_{iss} | Input Capacitance | — | 1570 | — | pF | $V_{GS} = 0V$ $V_{DS} = 13V$ $f = 1.0\text{MHz}$ |
| C_{oss} | Output Capacitance | — | 490 | — | | |
| C_{rss} | Reverse Transfer Capacitance | — | 210 | — | | |

Diode Characteristics

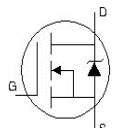
| | Parameter | Min. | Typ. | Max. | Units | Conditions |
|----------|---|------|------|------|-------|--|
| I_S | Continuous Source Current (Body Diode) | — | — | 45 | A | MOSFET symbol showing the integral reverse p-n junction diode.  |
| I_{SM} | Pulsed Source Current (Body Diode) ⑤ | — | — | 130 | | |
| V_{SD} | Diode Forward Voltage | — | 0.81 | 1.0 | V | $T_J = 25^\circ\text{C}, I_S = 13A, V_{GS} = 0V$ ⑦ |
| t_{rr} | Reverse Recovery Time | — | 17 | 26 | ns | $T_J = 25^\circ\text{C}, I_F = 13A$ |
| Q_{rr} | Reverse Recovery Charge | — | 14 | 21 | nC | $di/dt = 200A/\mu s$ ⑦ |

Notes:

 ⑦ Pulse width $\leq 400\mu s$; duty cycle $\leq 2\%$.

Absolute Maximum Ratings

| | Parameter | Max. | Units |
|--------------------------------|----------------------------|--------------|-------|
| $P_D @ T_A = 25^\circ\text{C}$ | Power Dissipation ③ | 2.2 | W |
| $P_D @ T_A = 70^\circ\text{C}$ | Power Dissipation ③ | 1.4 | |
| $P_D @ T_C = 25^\circ\text{C}$ | Power Dissipation ④ | 36 | |
| T_P | Peak Soldering Temperature | 270 | °C |
| T_J | Operating Junction and | -40 to + 150 | |
| T_{STG} | Storage Temperature Range | | |

Thermal Resistance

| | Parameter | Typ. | Max. | Units |
|--------------------|--------------------------|------|-------|-------|
| $R_{\theta JA}$ | Junction-to-Ambient ③⑩ | — | 58 | °C/W |
| $R_{\theta JA}$ | Junction-to-Ambient ③⑩ | 12.5 | — | |
| $R_{\theta JA}$ | Junction-to-Ambient ⑨⑩ | 20 | — | |
| $R_{\theta JC}$ | Junction-to-Case ④⑩ | — | 3.5 | |
| $R_{\theta J-PCB}$ | Junction-to-PCB Mounted | 1.0 | — | |
| | Linear Derating Factor ③ | | 0.017 | W/°C |

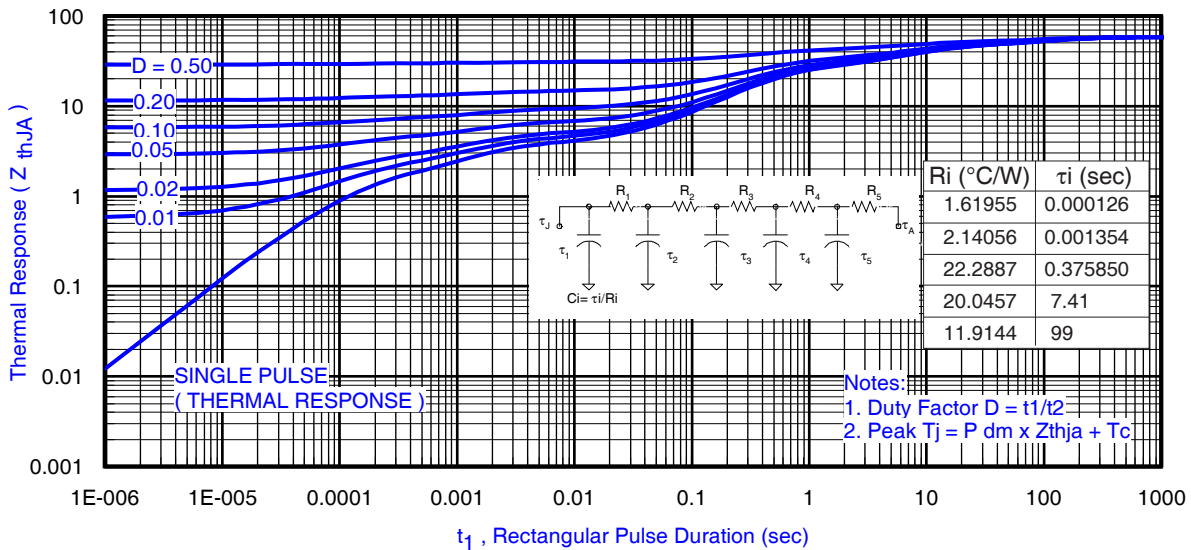
Fig 3. Maximum Effective Transient Thermal Impedance, Junction-to-Ambient ③
Notes:

- ③ Used double sided cooling, mounting pad with large heatsink.
- ④ R_{θ} is measured at T_J of approximately 90°C .
- ⑨ Mounted on minimum footprint full size board with metalized back and with small clip heatsink.

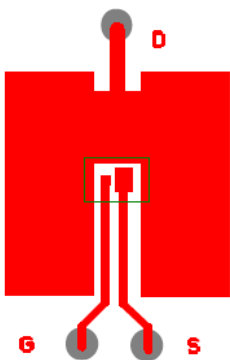

③ Surface mounted on 1 in. square Cu (still air).

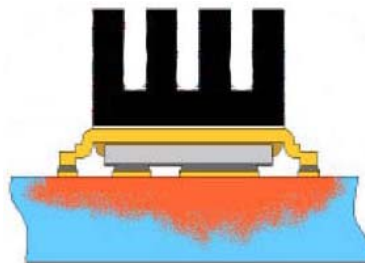

⑨ Mounted to a PCB with small clip heatsink (still air)

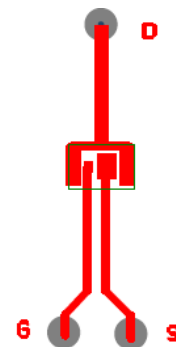

⑨ Mounted on minimum footprint full size board with metalized back and with small clip heatsink (still air)

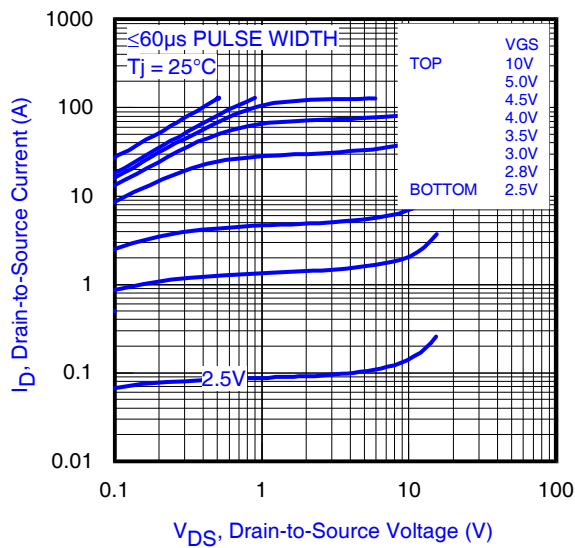
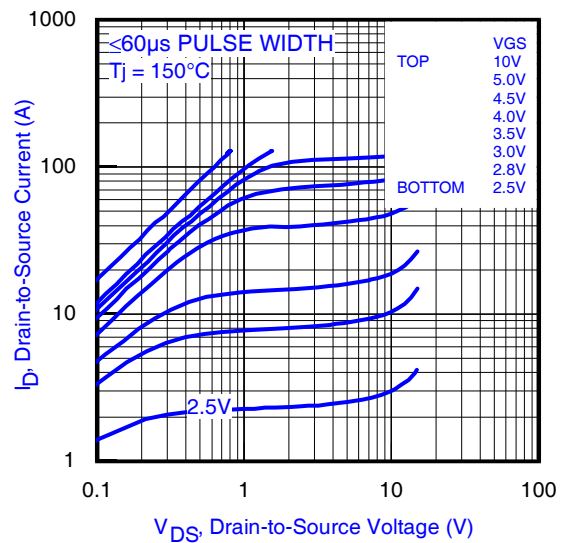
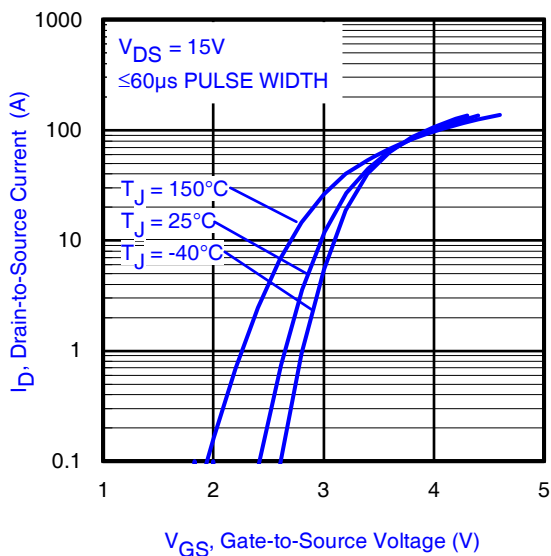
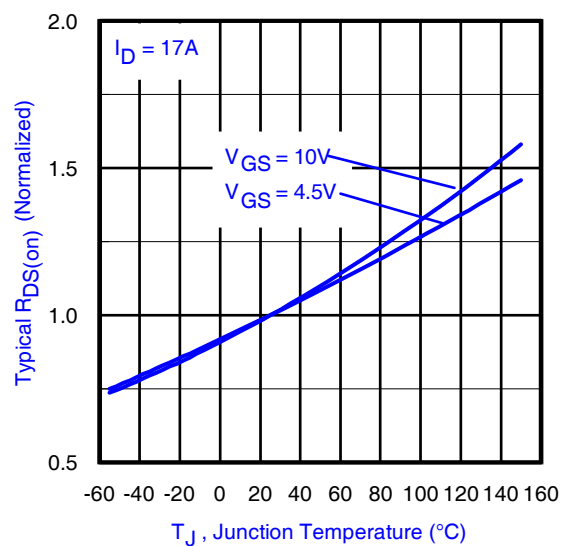
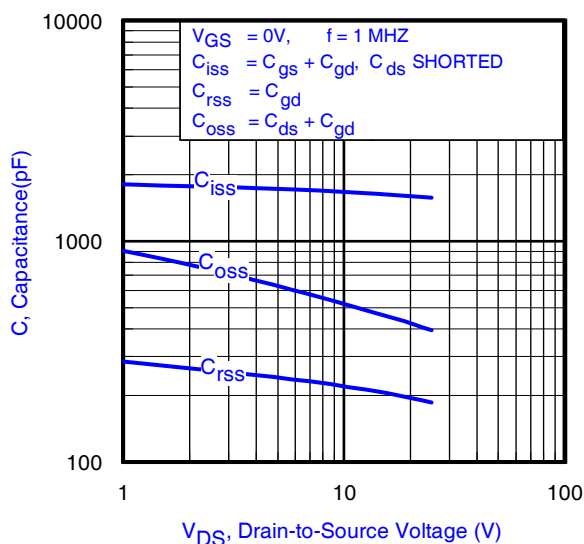
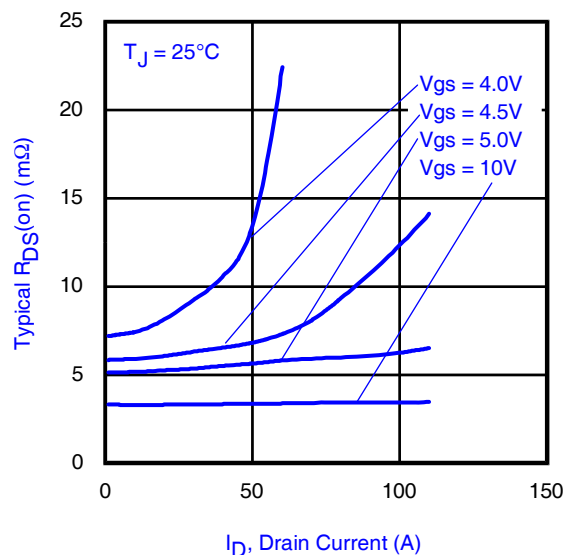
Fig 4. Typical Output Characteristics

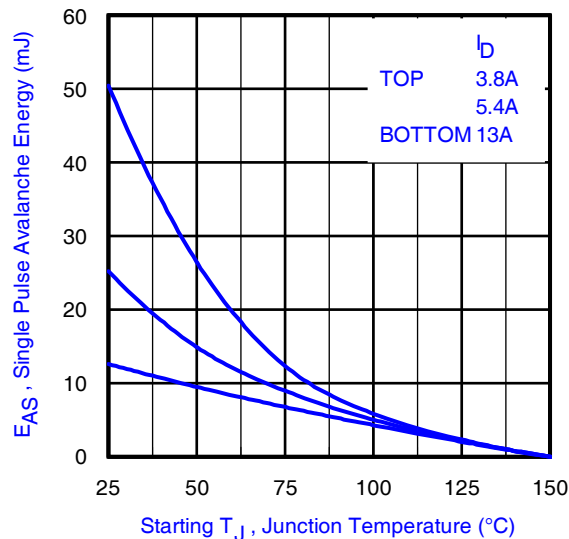
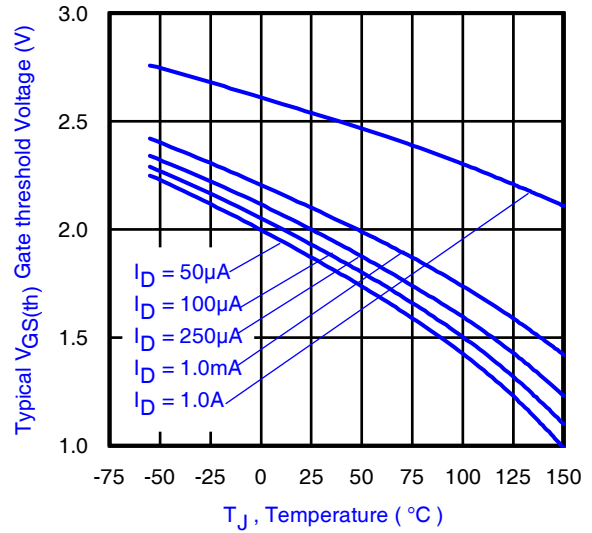
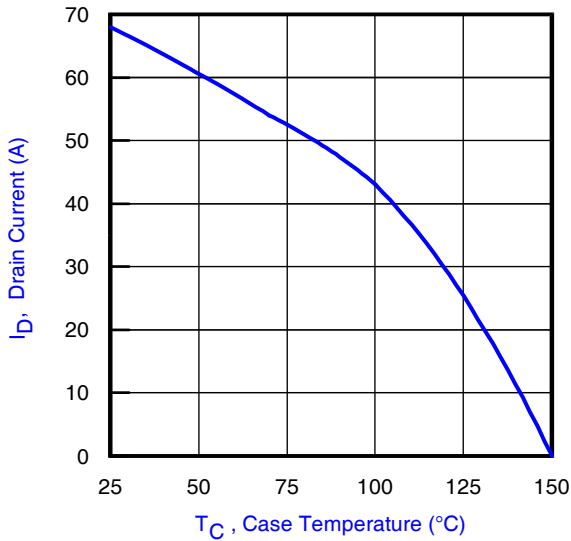
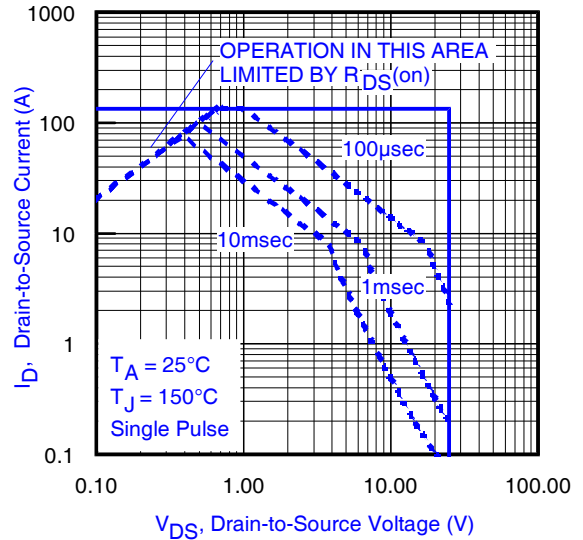
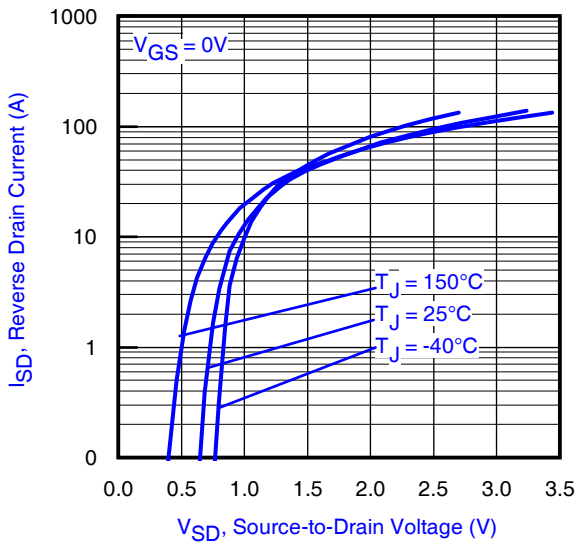
Fig 5. Typical Output Characteristics

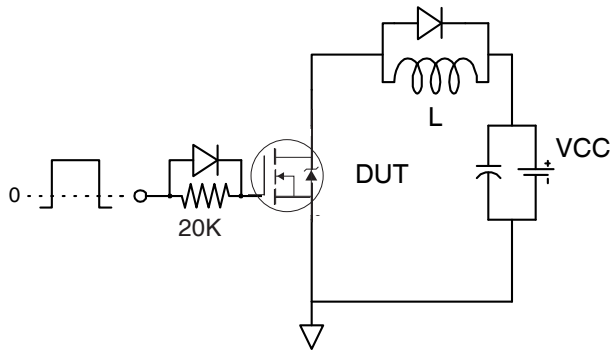
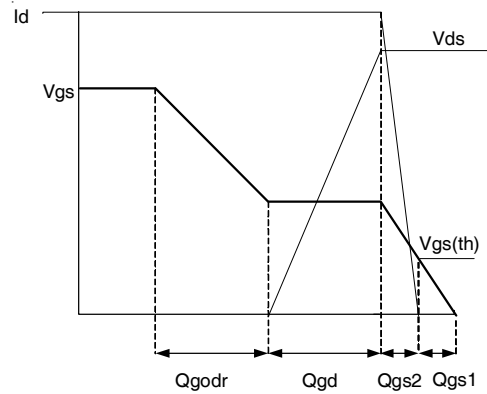
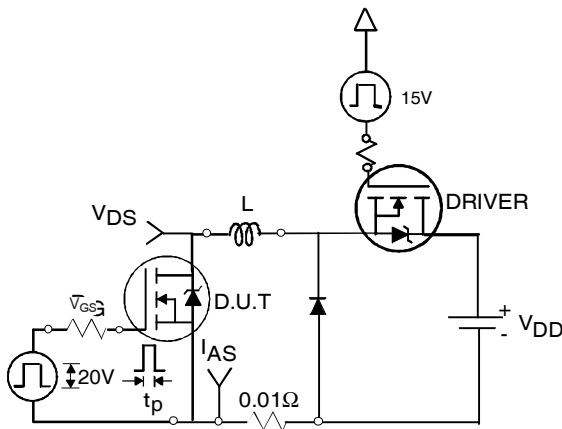
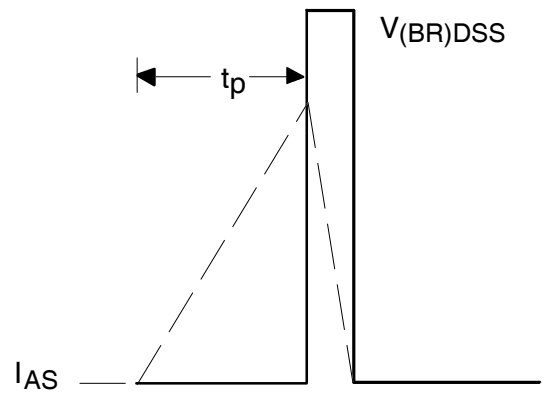
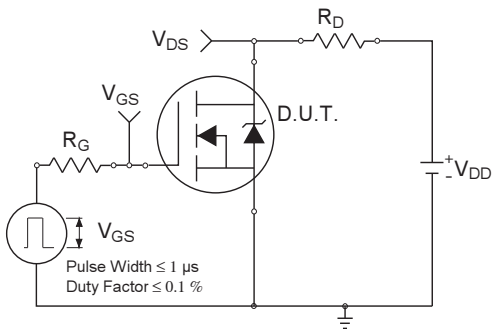
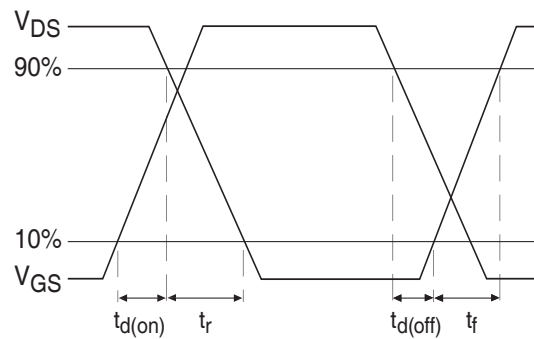
Fig 6. Typical Transfer Characteristics

Fig 7. Normalized On-Resistance vs. Temperature

Fig 8. Typical Capacitance vs. Drain-to-Source Voltage

Fig 9. Typical On-Resistance Vs. Drain Current and Gate Voltage



Fig 15a. Gate Charge Test Circuit

Fig 15b. Gate Charge Waveform

Fig 16a. Unclamped Inductive Test Circuit

Fig 16b. Unclamped Inductive Waveforms

Fig 17a. Switching Time Test Circuit

Fig 17b. Switching Time Waveforms

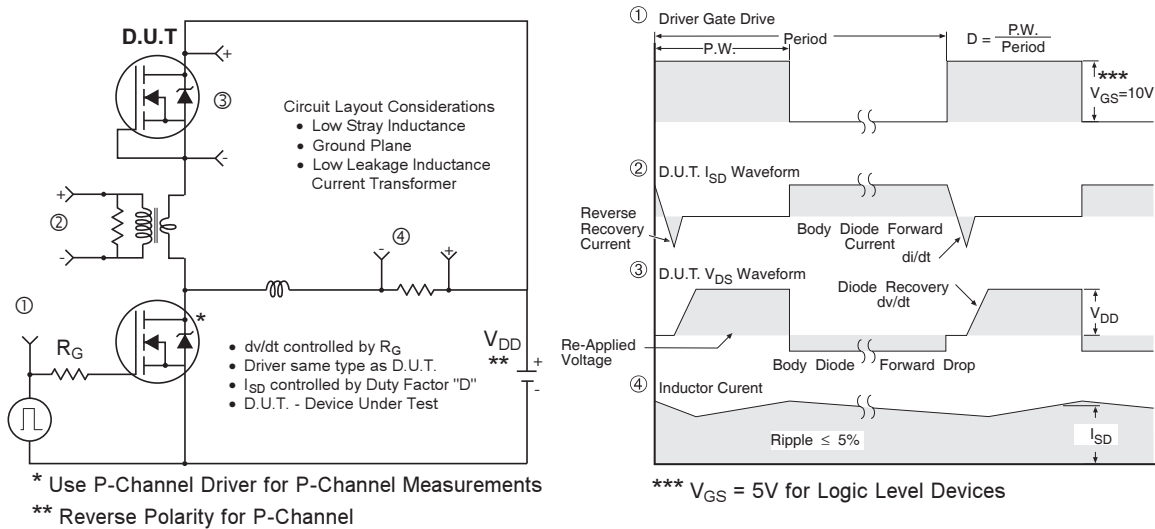
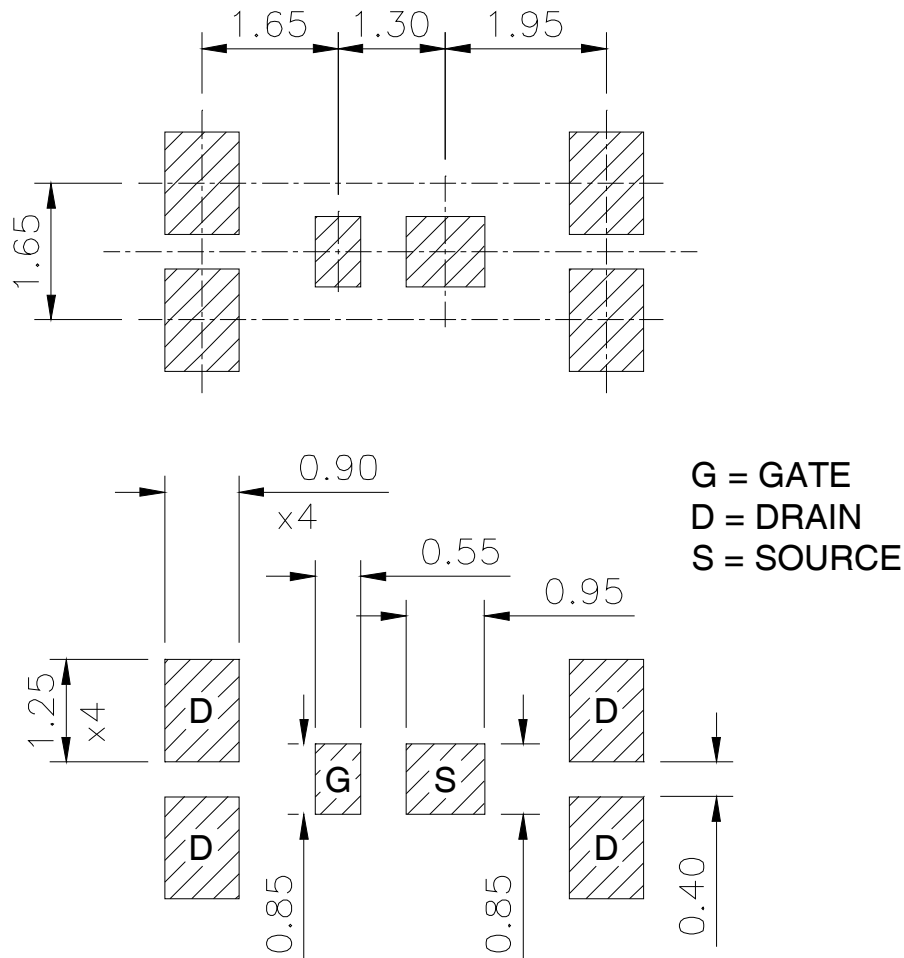

Fig 18. Diode Reverse Recovery Test Circuit for HEXFET® Power MOSFETs

DirectFET™ Board Footprint, SQ Outline (Small Size Can, Q-Designation).

Please see DirectFET application note AN-1035 for all details regarding the assembly of DirectFET. This includes all recommendations for stencil and substrate designs.



DirectFET™ Outline Dimension, SQ Outline (Small Size Can, Q-Designation).

Please see DirectFET application note AN-1035 for all details regarding the assembly of DirectFET.

This includes all recommendations for stencil and substrate designs.

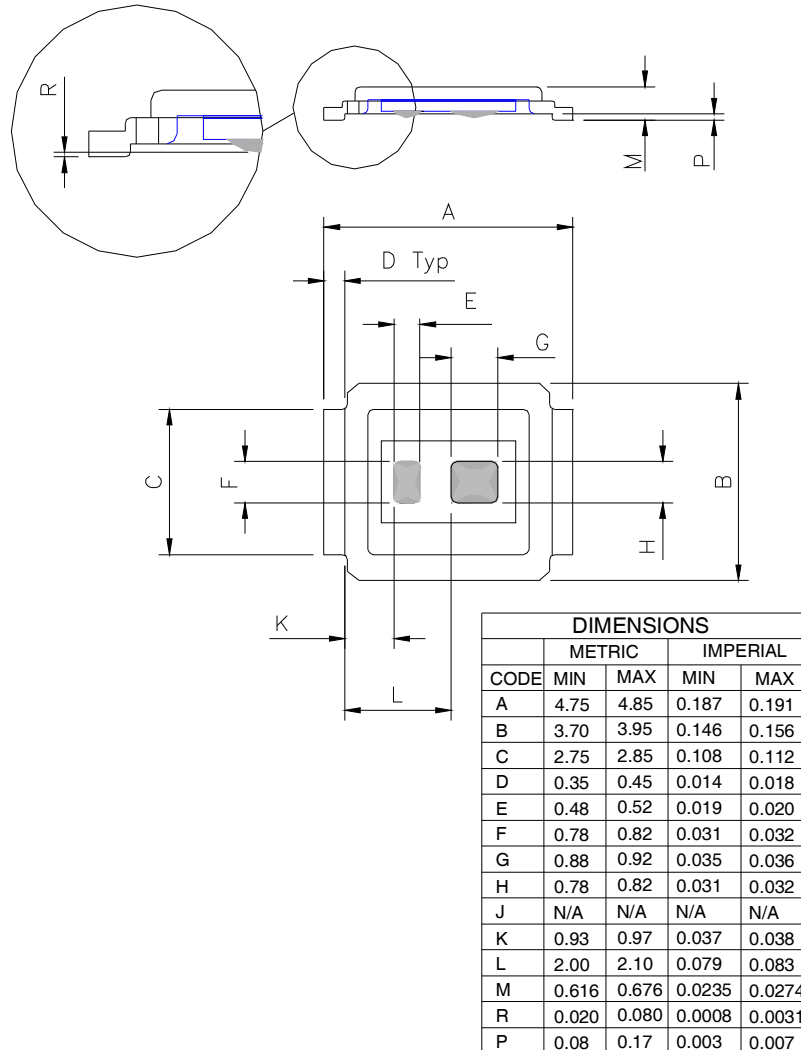

DirectFET™ Part Marking

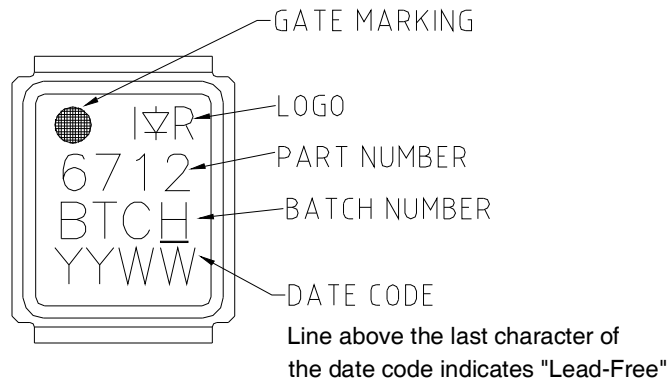

Note: For the most current drawing please refer to IR website at <http://www.irf.com/package/>

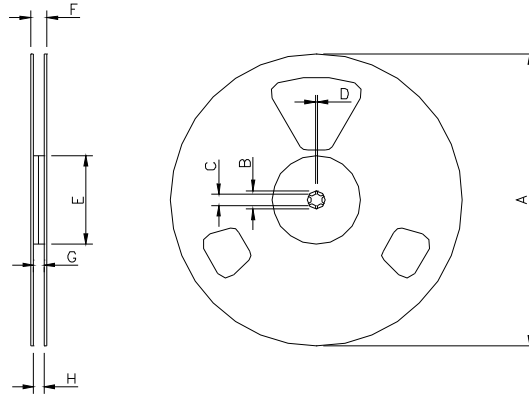
DirectFET™ Tape & Reel Dimension (Showing component orientation).

NOTE: Controlling dimensions in mm
 Std reel quantity is 4800 parts. (ordered as IRF6712TRPBF). For 1000 parts on 7" reel, order IRF6712TR1PBF

| REEL DIMENSIONS | | | | | | | | |
|-----------------|----------------------------|------|----------|-------|-----------------------|-------|----------|------|
| CODE | STANDARD OPTION (QTY 4800) | | | | TR1 OPTION (QTY 1000) | | | |
| | METRIC | | IMPERIAL | | METRIC | | IMPERIAL | |
| | MIN | MAX | MIN | MAX | MIN | MAX | MIN | MAX |
| A | 330.0 | N.C | 12.992 | N.C | 177.77 | N.C | 6.9 | N.C |
| B | 20.2 | N.C | 0.795 | N.C | 19.06 | N.C | 0.75 | N.C |
| C | 12.8 | 13.2 | 0.504 | 0.520 | 13.5 | 12.8 | 0.53 | 0.50 |
| D | 1.5 | N.C | 0.059 | N.C | 1.5 | N.C | 0.059 | N.C |
| E | 100.0 | N.C | 3.937 | N.C | 58.72 | N.C | 2.31 | N.C |
| F | N.C | 18.4 | N.C | 0.724 | N.C | 13.50 | N.C | 0.53 |
| G | 12.4 | 14.4 | 0.488 | 0.567 | 11.9 | 12.01 | 0.47 | N.C |
| H | 11.9 | 15.4 | 0.469 | 0.606 | 11.9 | 12.01 | 0.47 | N.C |

Loaded Tape Feed Direction

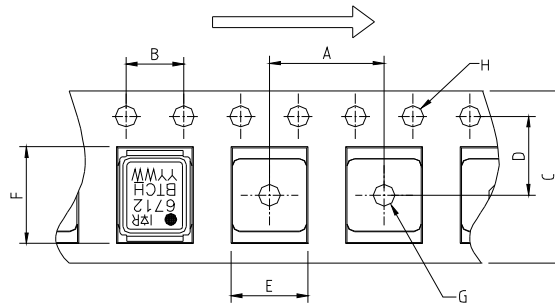

NOTE: CONTROLLING DIMENSIONS IN MM

| CODE | DIMENSIONS | | | |
|------|------------|-------|----------|-------|
| | METRIC | | IMPERIAL | |
| | MIN | MAX | MIN | MAX |
| A | 7.90 | 8.10 | 0.311 | 0.319 |
| B | 3.90 | 4.10 | 0.154 | 0.161 |
| C | 11.90 | 12.30 | 0.469 | 0.484 |
| D | 5.45 | 5.55 | 0.215 | 0.219 |
| E | 4.00 | 4.20 | 0.158 | 0.165 |
| F | 5.00 | 5.20 | 0.197 | 0.205 |
| G | 1.50 | N.C | 0.059 | N.C |
| H | 1.50 | 1.60 | 0.059 | 0.063 |

Note: For the most current drawing please refer to IR website at <http://www.irf.com/package/>

单击下面可查看定价，库存，交付和生命周期等信息

[>>Infineon Technologies\(英飞凌\)](#)