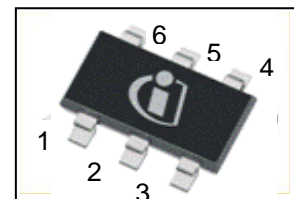
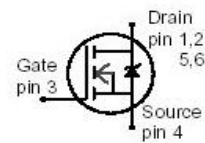

OptiMOS[®] 2 Small-Signal-Transistor
Features

- N-channel
- Enhancement mode
- Super Logic level (2.5V rated)
- Avalanche rated
- dv/dt rated
- Pb-free lead plating; RoHS compliant
- Qualified according to AEC Q101
- Halogen free according to IEC61249-2-21

Product Summary

| | | |
|------------------|-----------------------|----|
| V_{DS} | 20 | V |
| $R_{DS(on),max}$ | $V_{GS}=4.5\text{ V}$ | 22 |
| | $V_{GS}=2.5\text{ V}$ | 36 |
| I_D | 7.5 | A |

TSOP-6

| Type | Package | Tape and Reel Information | Marking | Lead Free | Packing |
|----------|---------|---------------------------|---------|-----------|---------|
| BSL202SN | TSOP-6 | H6327: 3000 pcs/ reel | sPD | Yes | Non dry |

Maximum ratings, at $T_j=25\text{ °C}$, unless otherwise specified

| Parameter | Symbol | Conditions | Value | Unit |
|-------------------------------------|-------------------|--|----------------|-------------------|
| Continuous drain current | I_D | $T_A=25\text{ °C}$ | 7.5 | A |
| | | $T_A=70\text{ °C}$ | 6.0 | |
| Pulsed drain current | $I_{D,pulse}$ | $T_A=25\text{ °C}$ | 30 | |
| Avalanche energy, single pulse | E_{AS} | $I_D=7.5\text{ A}$, $R_{GS}=25\ \Omega$ | 30 | mJ |
| Reverse diode dv/dt | dv/dt | $I_D=7.5\text{ A}$, $V_{DS}=16\text{ V}$, $di/dt=200\text{ A}/\mu\text{s}$, $T_{j,max}=150\text{ °C}$ | 6 | kV/ μs |
| Gate source voltage | V_{GS} | | ± 12 | V |
| Power dissipation ¹⁾ | P_{tot} | $T_A=25\text{ °C}$ | 2 | W |
| Operating and storage temperature | T_j , T_{stg} | | -55 ... 150 | °C |
| ESD Class | | JESD22-A114 -HBM | 0 (0V to 250V) | |
| Soldering Temperature | | | 260 °C | |
| IEC climatic category; DIN IEC 68-1 | | | 55/150/56 | |

| Parameter | Symbol | Conditions | Values | | | Unit |
|-----------|--------|------------|--------|------|------|------|
| | | | min. | typ. | max. | |

Thermal characteristics

| | | | | | | |
|--|------------|--|---|---|------|-----|
| Thermal resistance, junction - minimal footprint | R_{thJS} | | - | - | 50 | K/W |
| SMD version, device on PCB | R_{thJA} | minimal footprint | - | - | 230 | |
| | | 6 cm ² cooling area ¹⁾ | - | - | 62.5 | |

Electrical characteristics, at $T_j=25\text{ }^\circ\text{C}$, unless otherwise specified
Static characteristics

| | | | | | | |
|----------------------------------|---------------|--|-----|------|-----|---------------|
| Drain-source breakdown voltage | $V_{(BR)DSS}$ | $V_{GS}=0\text{ V}, I_D=250\text{ }\mu\text{A}$ | 20 | - | - | V |
| Gate threshold voltage | $V_{GS(th)}$ | $V_{DS}=V_{GS}, I_D=30\text{ }\mu\text{A}$ | 0.7 | 0.95 | 1.2 | |
| Drain-source leakage current | I_{DSS} | $V_{DS}=20\text{ V}, V_{GS}=0\text{ V}, T_j=25\text{ }^\circ\text{C}$ | - | - | 1 | μA |
| | | $V_{DS}=20\text{ V}, V_{GS}=0\text{ V}, T_j=150\text{ }^\circ\text{C}$ | - | - | 100 | |
| Gate-source leakage current | I_{GSS} | $V_{GS}=12\text{ V}, V_{DS}=0\text{ V}$ | - | - | 100 | nA |
| Drain-source on-state resistance | $R_{DS(on)}$ | $V_{GS}=2.5\text{ V}, I_D=5.9\text{ A}$ | - | 26 | 36 | m Ω |
| | | $V_{GS}=4.5\text{ V}, I_D=7.5\text{ A}$ | - | 17 | 22 | |
| Transconductance | g_{fs} | $ V_{DS} >2 I_D R_{DS(on)max}, I_D=7.5\text{ A}$ | | 25 | - | S |

¹⁾ Device on 40 mm x 40 mm x 1.5 mm epoxy PCB FR4 with 6 cm² (single layer, 70 μm thick) copper area for drain connection. PCB is vertical in still air. ($t < 5\text{ sec.}$)

| Parameter | Symbol | Conditions | Values | | | Unit |
|-----------|--------|------------|--------|------|------|------|
| | | | min. | typ. | max. | |

Dynamic characteristics

| | | | | | | |
|------------------------------|--------------|---|---|------|------|----|
| Input capacitance | C_{iss} | $V_{GS}=0\text{ V}, V_{DS}=10\text{ V},$ $f=1\text{ MHz}$ | - | 863 | 1147 | pF |
| Output capacitance | C_{oss} | | - | 278 | 370 | |
| Reverse transfer capacitance | C_{rss} | | - | 40 | 60 | |
| Turn-on delay time | $t_{d(on)}$ | $V_{DD}=10\text{ V}, V_{GS}=4.5\text{ V},$ $I_D=7.5\text{ A}, R_{G,ext}=6\ \Omega$ | - | 8.26 | - | ns |
| Rise time | t_r | | - | 27.5 | - | |
| Turn-off delay time | $t_{d(off)}$ | | - | 18.9 | - | |
| Fall time | t_f | | - | 4.06 | - | |

Gate Charge Characteristics

| | | | | | | |
|-----------------------|---------------|--|---|------|------|----|
| Gate to source charge | Q_{gs} | $V_{DD}=10\text{ V}, I_D=7.5\text{ A},$ $V_{GS}=0\text{ to }4.5\text{ V}$ | - | 1.82 | 2.42 | nC |
| Gate to drain charge | Q_{gd} | | - | 1.1 | 1.6 | |
| Gate charge total | Q_g | | - | 5.8 | 8.7 | |
| Gate plateau voltage | $V_{plateau}$ | | - | 2 | - | V |

Reverse Diode

| | | | | | | |
|----------------------------------|---------------|--|---|------|-----|----|
| Diode continuous forward current | I_S | $T_A=25\text{ }^\circ\text{C}$ | - | - | 2 | A |
| Diode pulse current | $I_{S,pulse}$ | | - | - | 30 | |
| Diode forward voltage | V_{SD} | $V_{GS}=0\text{ V}, I_F=7.5\text{ A},$ $T_j=25\text{ }^\circ\text{C}$ | - | 0.8 | 1.2 | V |
| Reverse recovery time | t_{rr} | $V_R=10\text{ V}, I_F=7.5\text{ A},$ $di_F/dt=100\text{ A}/\mu\text{s}$ | - | 14.7 | - | ns |
| Reverse recovery charge | Q_{rr} | | - | 4.62 | - | nC |

1 Power dissipation

$P_{tot}=f(T_A)$

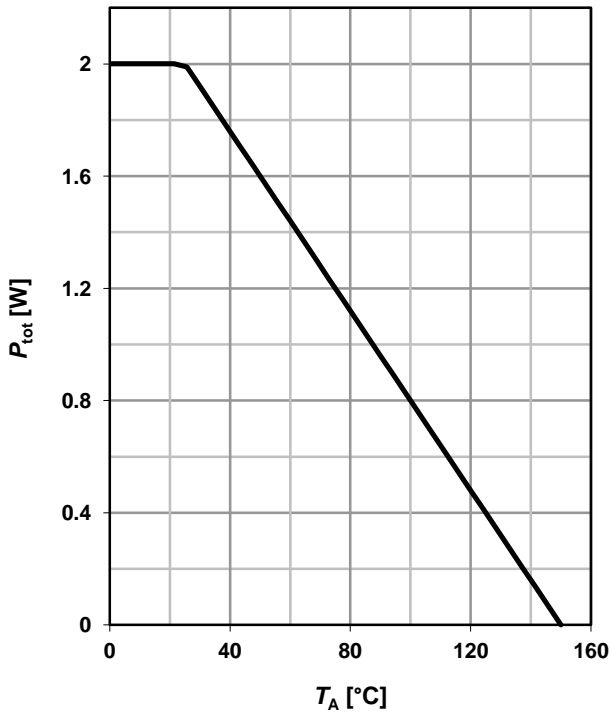

2 Drain current

$I_D=f(T_A); V_{GS} \geq 4.5 V$

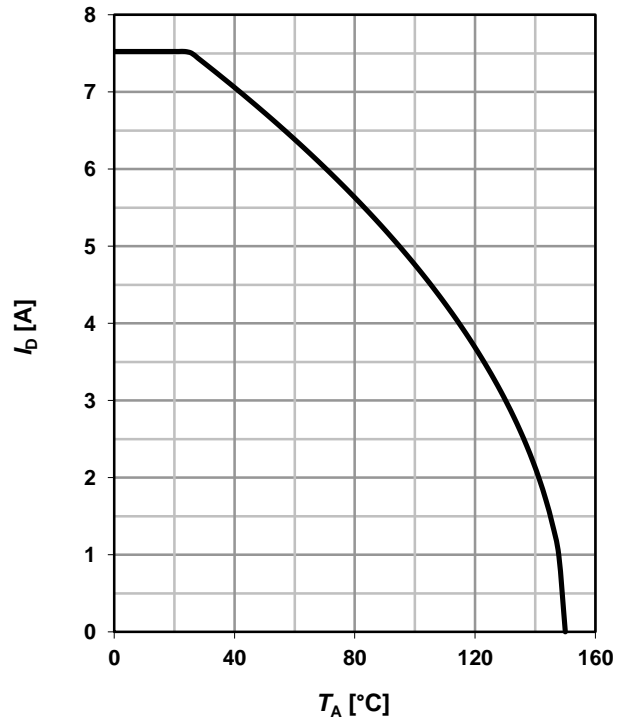

3 Safe operating area

$I_D=f(V_{DS}); T_A=25\text{ °C}; D=0$

parameter: t_p

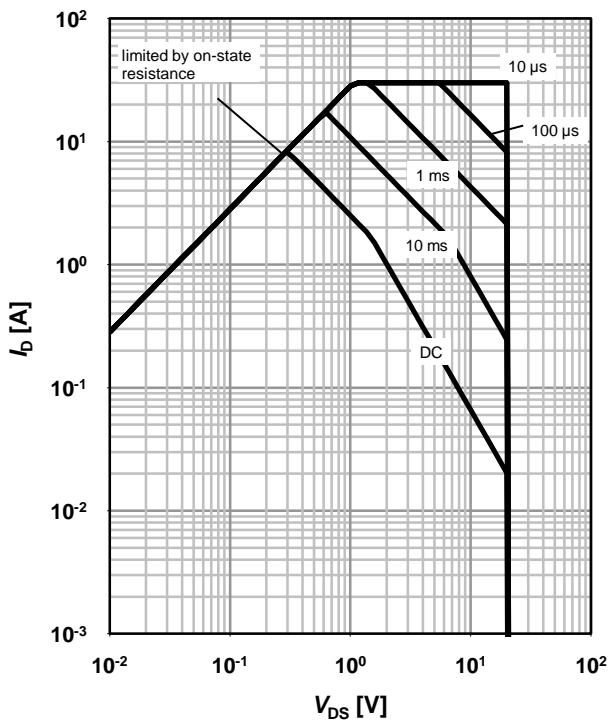

4 Max. transient thermal impedance

$Z_{thJA}=f(t_p)$

parameter: $D=t_p/T$

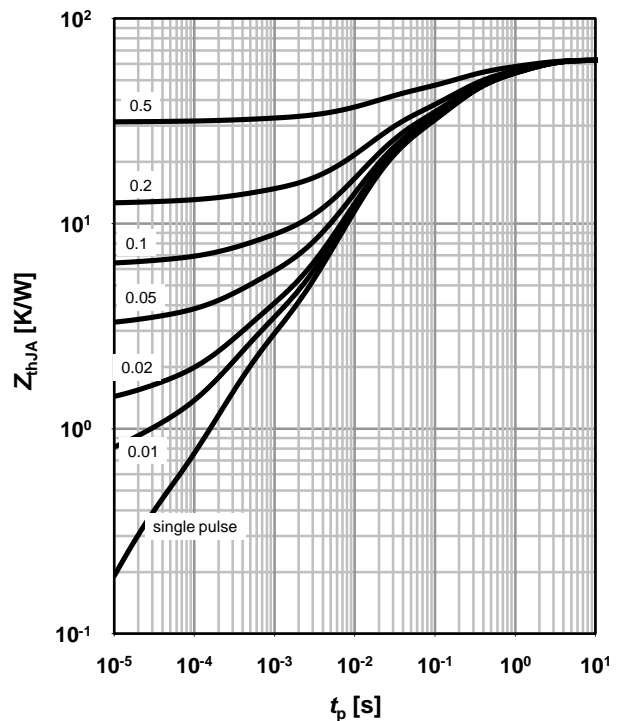

5 Typ. output characteristics

$I_D=f(V_{DS}); T_j=25\text{ }^\circ\text{C}$

parameter: V_{GS}

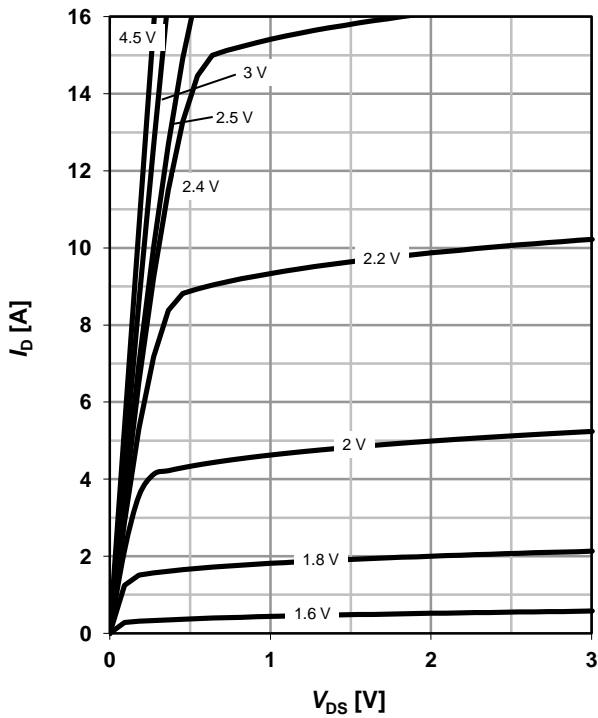

6 Typ. drain-source on resistance

$R_{DS(on)}=f(I_D); T_j=25\text{ }^\circ\text{C}$

parameter: V_{GS}

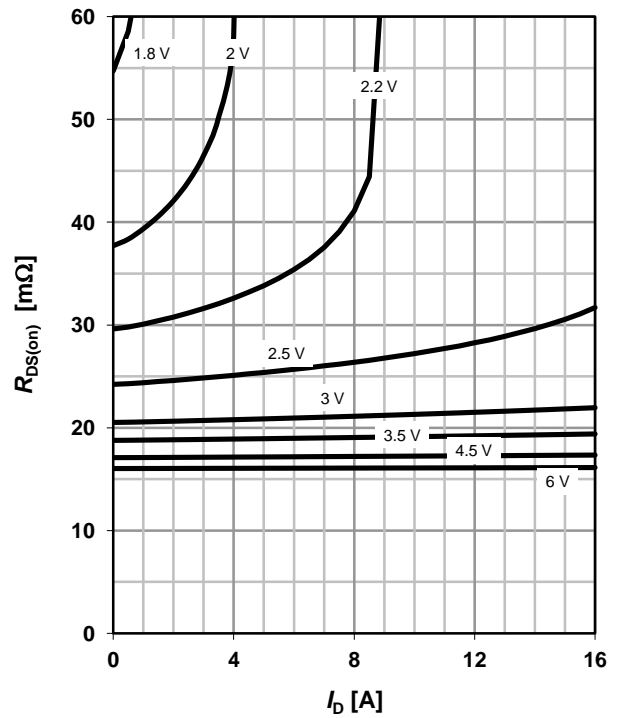

7 Typ. transfer characteristics

$I_D=f(V_{GS}); |V_{DS}|>2|I_D|R_{DS(on)max}$

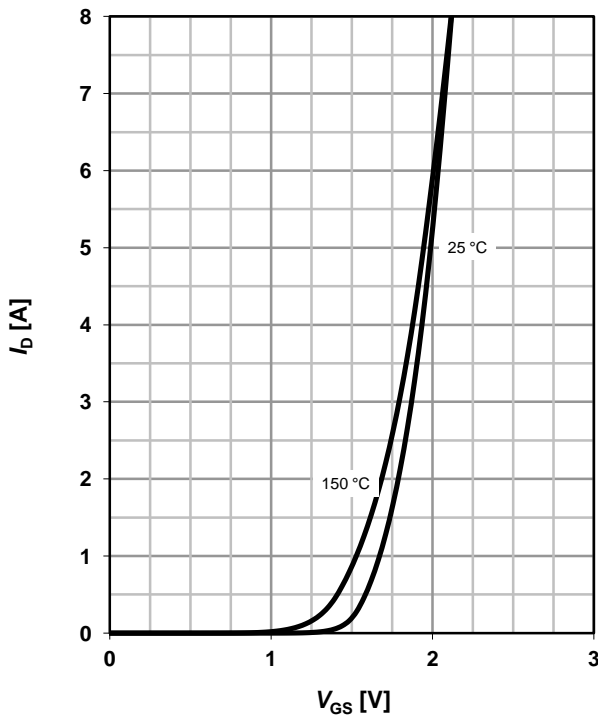

8 Typ. forward transconductance

$g_{fs}=f(I_D); T_j=25\text{ }^\circ\text{C}$

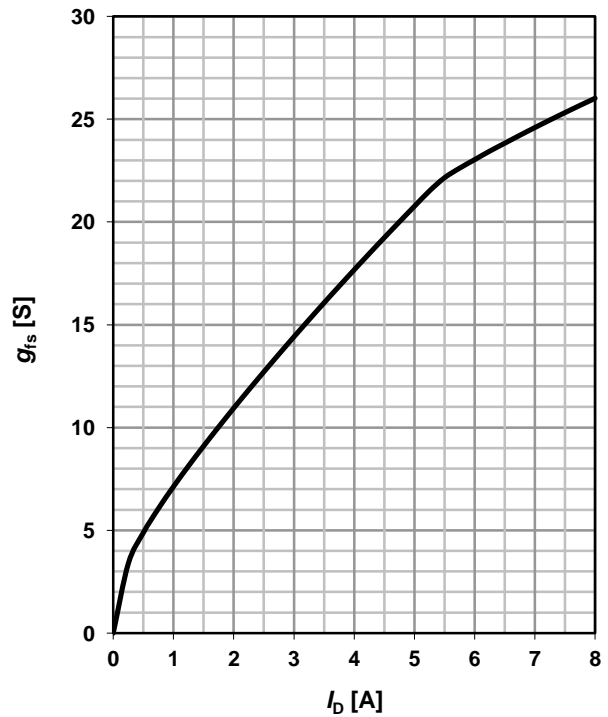

9 Drain-source on-state resistance

$R_{DS(on)}=f(T_j); I_D=7.5\text{ A}; V_{GS}=4.5\text{ V}$

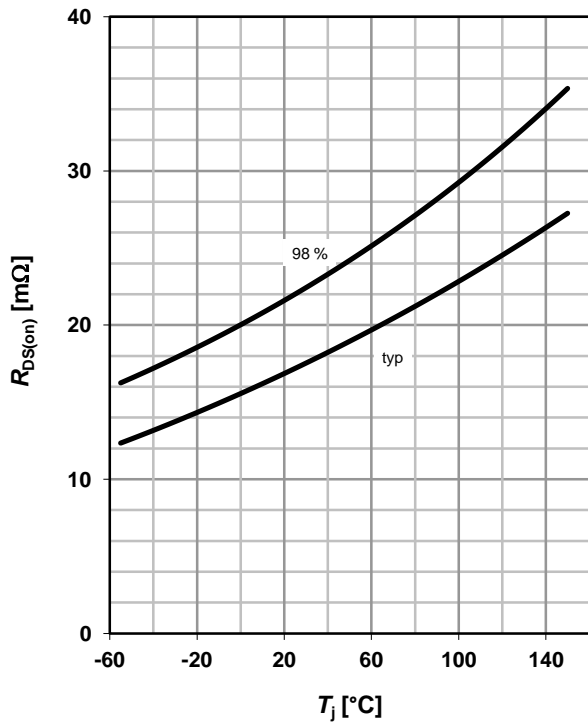

10 Typ. gate threshold voltage

$V_{GS(th)}=f(T_j); V_{DS}=V_{GS}; I_D=30\ \mu\text{A}$

parameter: I_D

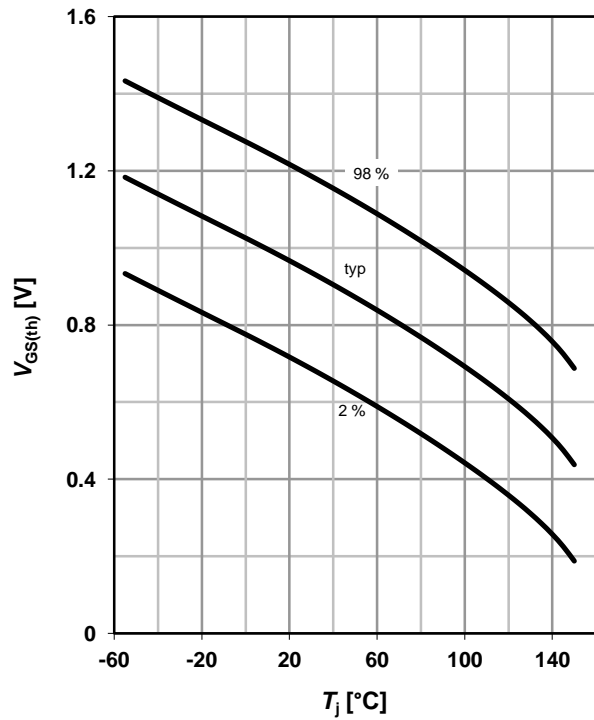

11 Typ. capacitances

$C=f(V_{DS}); V_{GS}=0\text{ V}; f=1\text{ MHz}; T_j=25^\circ\text{C}$

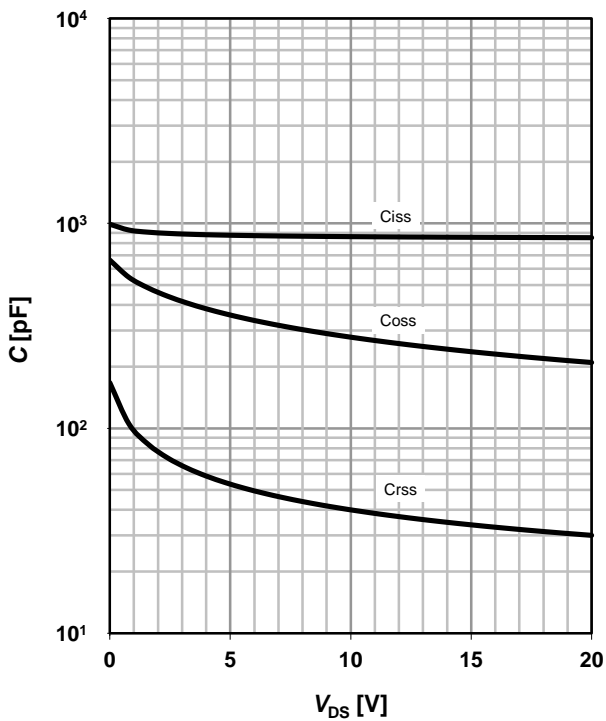

12 Forward characteristics of reverse diode

$I_F=f(V_{SD})$

parameter: T_j

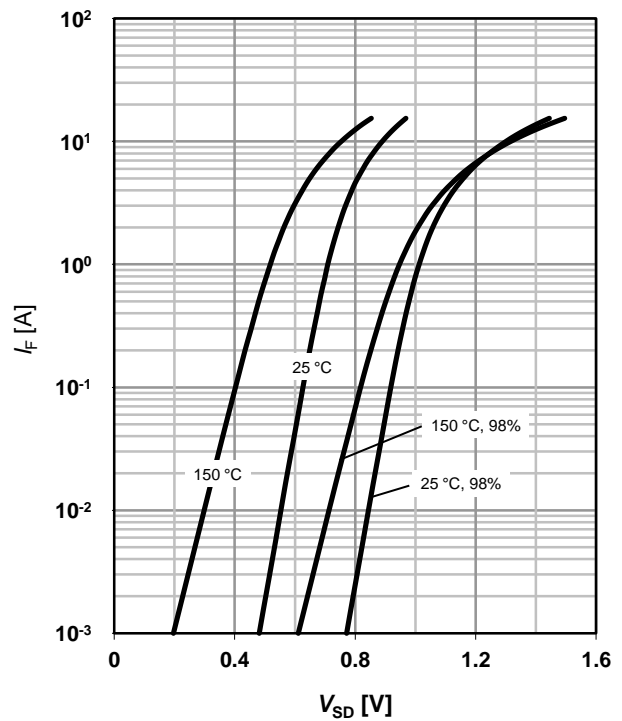

13 Avalanche characteristics

$I_{AS}=f(t_{AV}); R_{GS}=25 \Omega$

parameter: $T_{j(\text{start})}$

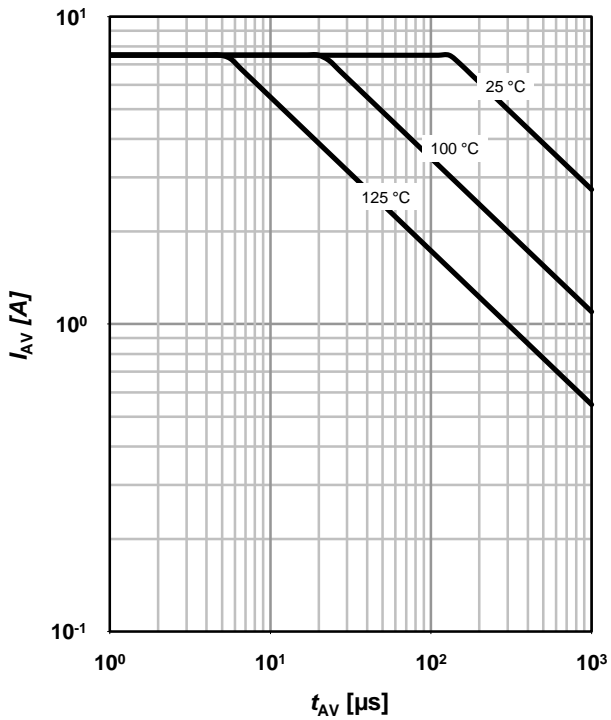

14 Typ. gate charge

$V_{GS}=f(Q_{\text{gate}}); I_D=7.5 \text{ A pulsed}$

parameter: V_{DD}

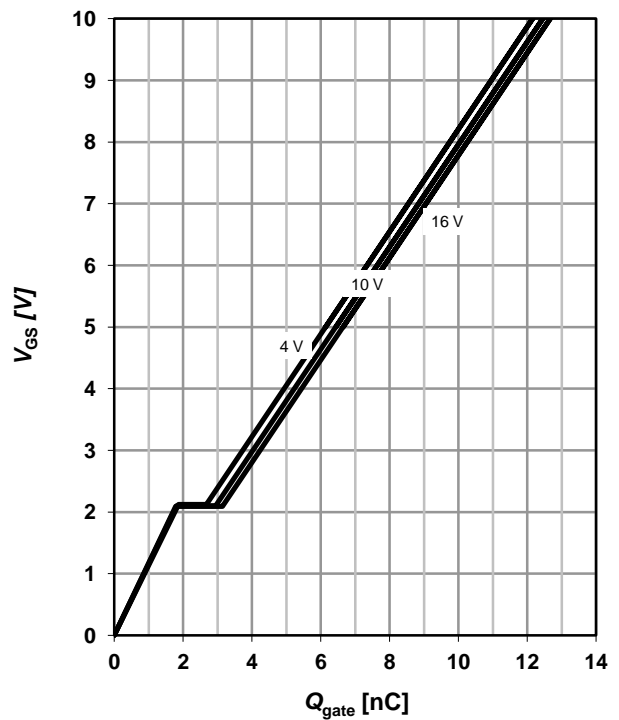

15 Drain-source breakdown voltage

$V_{BR(DSS)}=f(T_j); I_D=250 \mu\text{A}$

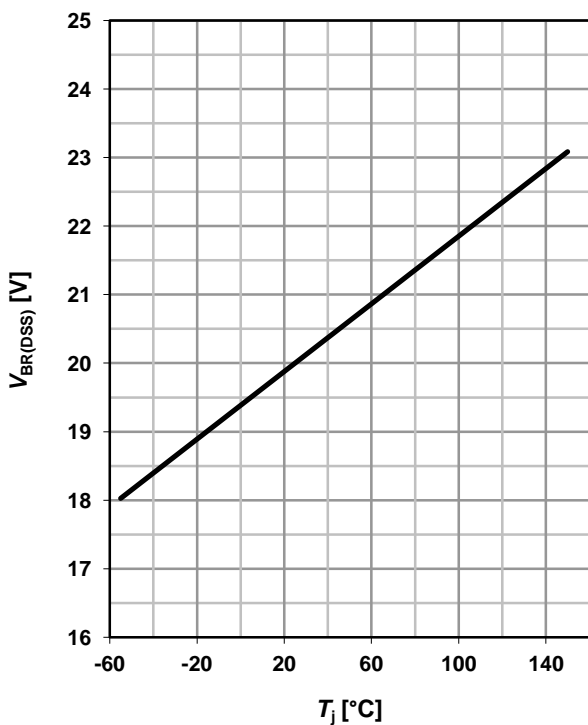

16 Gate charge waveforms

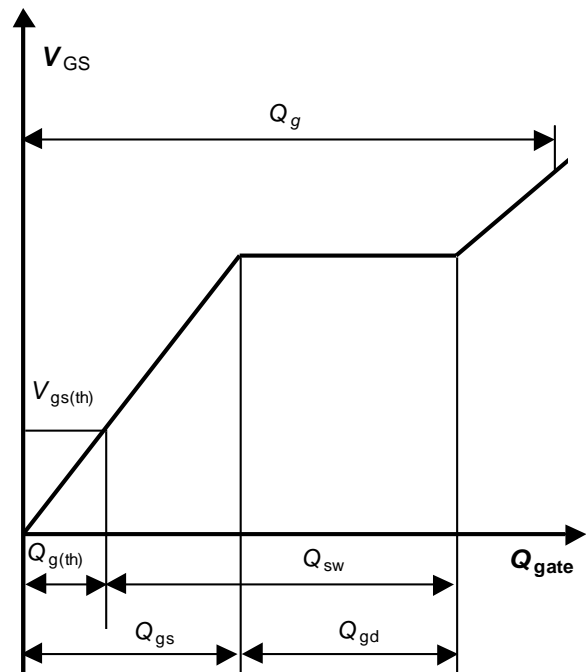

Package Outline:

TSOP6



GPX09300

Footprint:

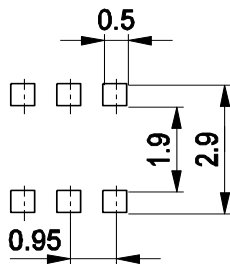

Remark: Wave soldering possible dep. on customers process conditions

HLG09283

Packaging:

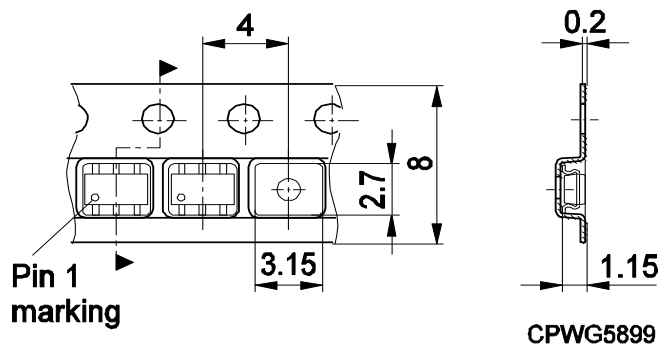

CPWG5899

Dimensions in mm

Published by**Infineon Technologies AG****81726 München, Germany****© Infineon Technologies AG 2006.****All Rights Reserved.****Attention please!**

The information given in this data sheet shall in no event be regarded as a guarantee of conditions or characteristics ("Beschaffheitsgarantie"). With respect to any examples or hints given herein, any typical values stated herein and/or any information regarding the application of the device, Infineon Technologies hereby disclaims any and all warranties and liabilities of any kind, including without limitation warranties of non-infringement of intellectual property rights of any third party.

Information

For further information on technology, delivery terms and conditions and prices please contact your nearest Infineon Technologies Office (www.infineon.com).

Warnings

Due to technical requirements components may contain dangerous substances. For information on the types in question please contact your nearest Infineon Technologies Office.

Infineon Technologies Components may only be used in life-support devices or systems with the express written approval of Infineon Technologies, if a failure of such components can reasonably be expected to cause the failure of that life-support device or system, or to affect the safety or effectiveness of that device or system. Life support devices or systems are intended to be implanted in the human body, or to support and/or maintain and sustain and/or protect human life. If they fail, it is reasonable to assume that the health of the user or other persons may be endangered.

单击下面可查看定价，库存，交付和生命周期等信息

[>>Infineon Technologies\(英飞凌\)](#)