

RADIATION HARDENED SYNCHRONOUS RECTIFIER SURFACE MOUNT (SMD-2)

60V, N-CHANNEL

Product Summary

Part Number	Radiation Level	RDS(on)	Q _G
IRHSLNA57064	100 kRads(Si)	6.1mΩ	160nC
IRHSLNA53064	300 kRads(Si)	6.1mΩ	160nC
IRHSLNA54064	600 kRads(Si)	6.1mΩ	160nC
IRHSLNA58064	1000 kRads(Si)	6.1mΩ	160nC

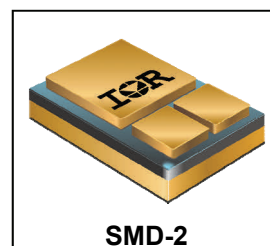

SMD-2

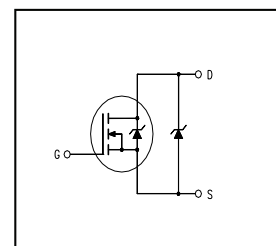

Description

The SynchFet family of Co-Pack RAD-Hard MOSFETs and Schottky diodes offers the designer an innovative, board space saving solution for switching regulator and power management applications. RAD-Hard MOSFETs utilize advanced processing techniques to achieve extremely low on-resistance per silicon area. Combining this technology with IR Hirel low forward drop Schottky rectifiers results in an extremely efficient device suitable for use in a wide variety of Military and Space applications.

Features

- Co-Pack N-channel RAD-Hard MOSFET and Schottky Diode
- Ideal for Synchronous Rectifiers in DC-DC Converters up to 75A Output
- Low Conduction Losses
- Low Switching Losses
- Low Vf Schottky Rectifier
- ESD Rating: Class 3B per MIL-STD-750, Method 1020

Absolute Maximum Ratings

Pre-Irradiation

Symbol	Parameter	Value	Units
$I_{D1} @ V_{GS} = 12V, T_C = 25^\circ C$	Continuous Drain or Source Current	75*	A
$I_{D2} @ V_{GS} = 12V, T_C = 100^\circ C$	Continuous Drain or Source Current	75*	
$I_{DM} @ T_C = 25^\circ C$	Pulsed Drain Current ①	300	
$P_D @ T_C = 25^\circ C$	Maximum Power Dissipation	250	W
	Linear Derating Factor	2.0	W/°C
V_{GS}	Gate-to-Source Voltage	± 20	V
E_{AS}	Single Pulse Avalanche Energy ④	370	mJ
I_{AR}	Avalanche Current ①	75	A
E_{AR}	Repetitive Avalanche Energy ①	25	mJ
$I_F (AV) @ T_C = 25^\circ C$	Schottky and Body Diode Avg. Forward Current ③	75*	A
$I_F (AV) @ T_C = 100^\circ C$	Schottky and Body Diode Avg. Forward Current ③	75*	
T_J T_{STG}	Operating Junction and Storage Temperature Range	-55 to + 150	°C
	Package Mounting Surface Temp.	300 (for 5s)	
	Weight	3.3 (Typical)	

* Current is limited by package
For Footnotes, refer to the page 2.

Electrical Characteristics @ T_j = 25°C (Unless Otherwise Specified)

Symbol	Parameter	Min.	Typ.	Max.	Units	Test Conditions
BV _{DSS}	Drain-to-Source Breakdown Voltage	60	—	—	V	V _{GS} = 0V, I _D = 1.0mA
R _{DS(on)}	Static Drain-to-Source On-Resistance	—	—	6.1	mΩ	V _{GS} = 12V, I _D = 45A ④
V _{GS(th)}	Gate Threshold Voltage	2.0	—	4.0	V	V _{DS} = V _{GS} , I _D = 1.0mA
G _{fs}	Forward Transconductance	45	—	—	S	V _{DS} = 15V, I _D = 45A ④
I _{DSS}	Zero Gate Voltage Drain Current	—	—	90	μA	V _{DS} = 48V, V _{GS} = 0V
		—	—	50	mA	V _{DS} = 48V, V _{GS} = 0V, T _J = 125°C
I _{GSS}	Gate-to-Source Leakage Forward	—	—	100	nA	V _{GS} = 20V
	Gate-to-Source Leakage Reverse	—	—	-100		V _{GS} = -20V
Q _G	Total Gate Charge	—	—	160	nC	I _D = 45A
Q _{GS}	Gate-to-Source Charge	—	—	55		V _{DS} = 30V
Q _{GD}	Gate-to-Drain ('Miller') Charge	—	—	65		V _{GS} = 12V
t _{d(on)}	Turn-On Delay Time	—	—	35	ns	V _{DD} = 30V
t _r	Rise Time	—	—	125		I _D = 45A
t _{d(off)}	Turn-Off Delay Time	—	—	75		R _G = 2.35Ω
t _f	Fall Time	—	—	50		V _{GS} = 12V
L _S + L _D	Total Inductance	—	6.6	—	nH	Measured from center of Drain pad to center of Source pad

Schottky Diode and Body Diode Ratings and Characteristics

Symbol	Parameter	Min.	Typ.	Max.	Units	Test Conditions
V _{SD}	Diode Forward Voltage	—	—	0.93	V	T _J = -55°C, I _S = 45A, V _{GS} = 0V ④
		—	—	0.9		T _J = 25°C, I _S = 45A, V _{GS} = 0V ④
		—	—	0.82		T _J = 125°C, I _S = 45A, V _{GS} = 0V ④
t _{rr}	Reverse Recovery Time	—	—	100	ns	T _J = 25°C, I _F = 45A, V _{DD} ≤ 30V
Q _{rr}	Reverse Recovery Charge	—	—	210	nC	di/dt = 100A/μs ④
L _S + L _D	Total Inductance	—	7.95	—	nH	Measured from center of drain pad to center of source pad (for Schottky only)
t _{on}	Forward Turn-On Time	Intrinsic turn-on time is negligible (turn-on is dominated by L _S +L _D)				

Thermal Resistance

Symbol	Parameter	Min.	Typ.	Max.	Units
R _{θJC}	Junction-to-Case (MOSFET)	—	—	0.5	°C/W
R _{θJC}	Junction-to-Case (Schottky)	—	—	0.7	

Footnotes:

- ① Repetitive Rating; Pulse width limited by maximum junction temperature.
- ② Pulse width ≤ 300 μs; Duty Cycle ≤ 2%
- ③ 50% Duty Cycle, Rectangular
- ④ V_{DD} = 25V, starting T_J = 25°C, L = 0.13mH, Peak I_L = 75A, V_{GS} = 12V
- ⑤ Total Dose Irradiation with V_{GS} Bias. 12 volt V_{GS} applied and V_{DS} = 0 during irradiation per MIL-STD-750, Method 1019, condition A.
- ⑥ Total Dose Irradiation with V_{DS} Bias. 48 volt V_{DS} applied and V_{GS} = 0 during irradiation per MIL-STD-750, Method 1019, condition A.
- ⑦ Specified Radiation Characteristics are for Radiation Hardened MOSFET die only.

Radiation Characteristics

IR HiRel radiation hardened MOSFETs are tested to verify their radiation hardness capability. The hardness assurance program at IR HiRel is comprised of two radiation environments. Every manufacturing lot is tested for total ionizing dose (per notes 5 and 6) using the TO-3 package. Both pre- and post-irradiation performance are tested and specified using the same drive circuitry and test conditions in order to provide a direct comparison.

Table1. Electrical Characteristics @ Tj = 25°C, Post Total Dose Irradiation ⑤⑥⑦

Symbol	Parameter	Up to 600 kRads (Si) ¹		1000 kRads (Si) ²		Units	Test Conditions
		Min.	Max.	Min.	Max.		
BV _{DSS}	Drain-to-Source Breakdown Voltage	60	—	60	—	V	V _{GS} = 0V, I _D = 1.0mA
V _{GS(th)}	Gate Threshold Voltage	2.0	4.0	1.5	4.0	V	V _{DS} = V _{GS} , I _D = 1.0mA
I _{GSS}	Gate-to-Source Leakage Forward	—	100	—	100	nA	V _{GS} = 20V
I _{GSS}	Gate-to-Source Leakage Reverse	—	-100	—	-100	nA	V _{GS} = -20V
I _{DSS}	Zero Gate Voltage Drain Current	—	10	—	25	μA	V _{DS} = 48V, V _{GS} = 0V
R _{DS(on)}	Static Drain-to-Source ④ On-State Resistance (TO-3)	—	6.1	—	7.1	mΩ	V _{GS} = 12V, I _D = 45A
R _{DS(on)}	Static Drain-to-Source ④ On-State Resistance (SMD-2)	—	6.1	—	7.1	mΩ	V _{GS} = 12V, I _D = 45A
V _{SD}	Diode Forward Voltage ④	—	1.3	—	1.3	V	V _{GS} = 0V, I _S = 45A

1. Part numbers IRHSLNA57064, IRHSLNA53064 and IRHLSNA54064
2. Part numbers IRHSLNA58064

IR HiRel radiation hardened MOSFETs have been characterized in heavy ion environment for Single Event Effects (SEE). Single Event Effects characterization is illustrated in Fig. a and Table 2.

Table 2. Typical Single Event Effect Safe Operating Area

LET (MeV/(mg/cm ²))	Energy (MeV)	Range (μm)	VDS (V)				
			@ VGS = 0V	@ VGS=-5V	@ VGS=-10V	@ VGS =-15V	@ VGS=-20V
38 ± 5%	300 ± 7.5%	38 ± 7.5%	60	60	60	60	30
61 ± 5%	330 ± 7.5%	31 ± 10%	46	46	35	25	15
84 ± 5%	350 ± 10%	28 ± 7.5%	35	30	25	20	14

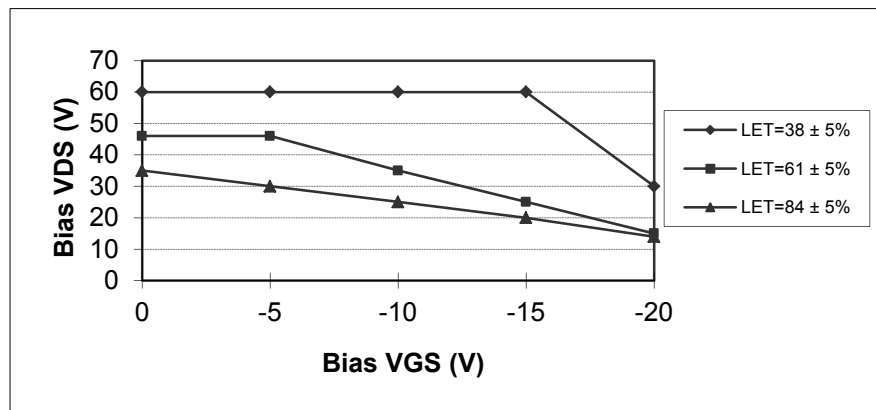

Fig a. Typical Single Event Effect, Safe Operating Area

For Footnotes, refer to the page 2.

Pre-Irradiation

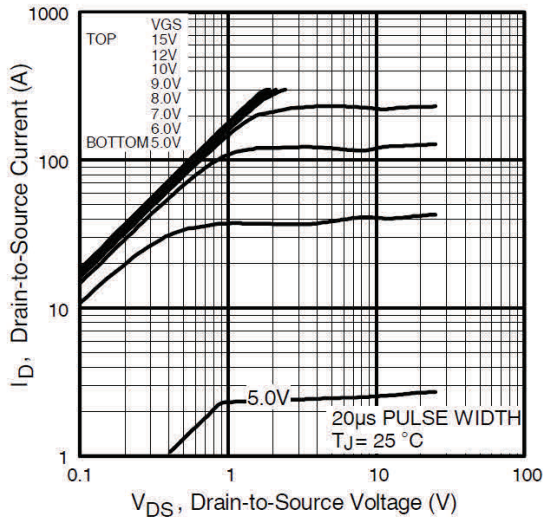

Fig 1. Typical Output Characteristics

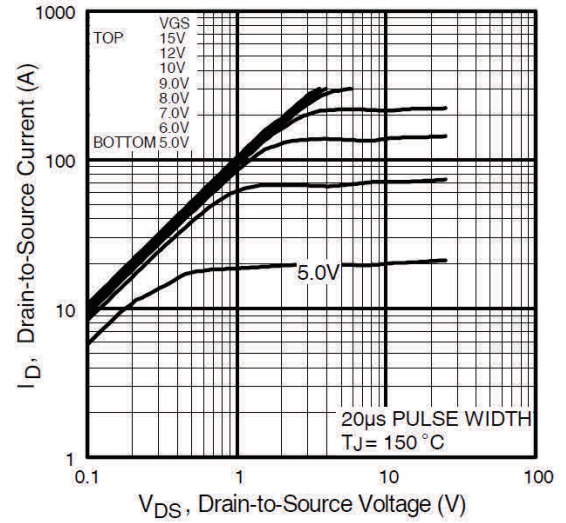

Fig 2. Typical Output Characteristics

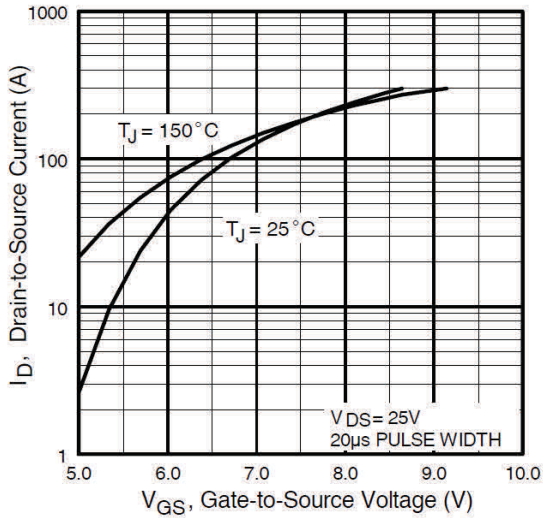

Fig 3. Typical Transfer Characteristics

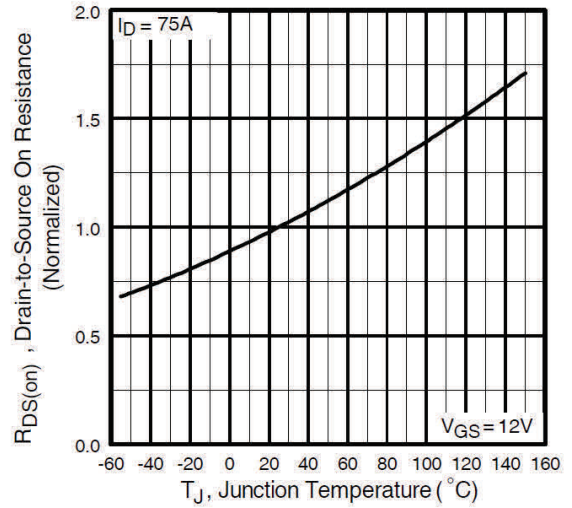

Fig 4. Normalized On-Resistance Vs. Temperature

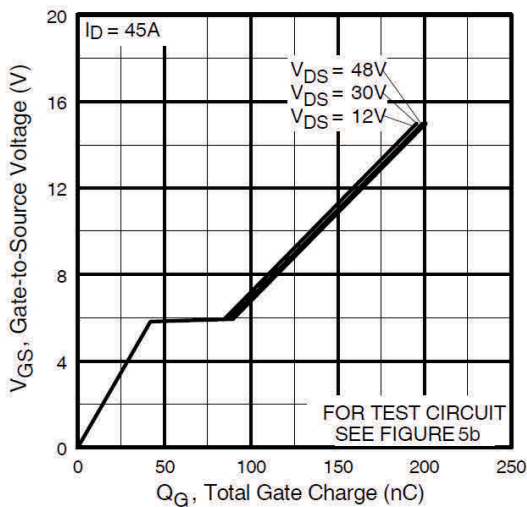

Fig 5. Typical Gate Charge Vs. Gate-to-Source Voltage

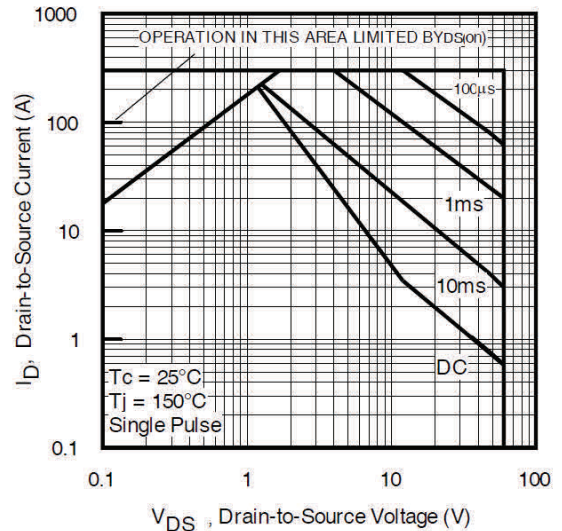

Fig 6. Maximum Safe Operating Area

Pre-Irradiation

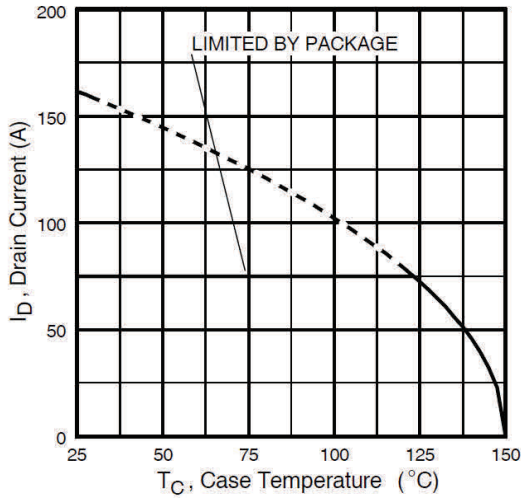

Fig 7. Maximum Drain Current Vs. Case Temperature

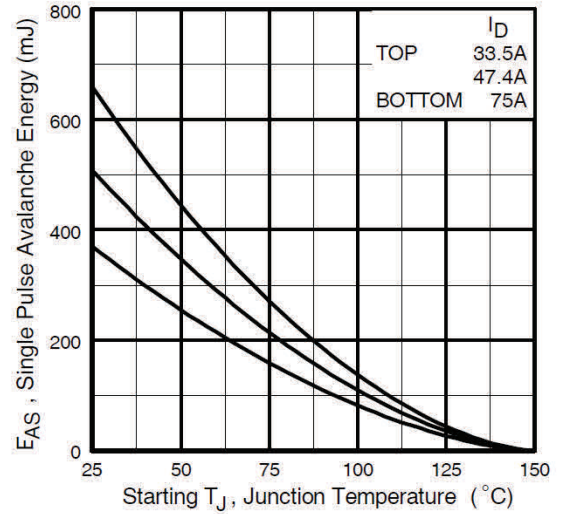

Fig 8. Maximum Avalanche Energy Vs. Drain Current

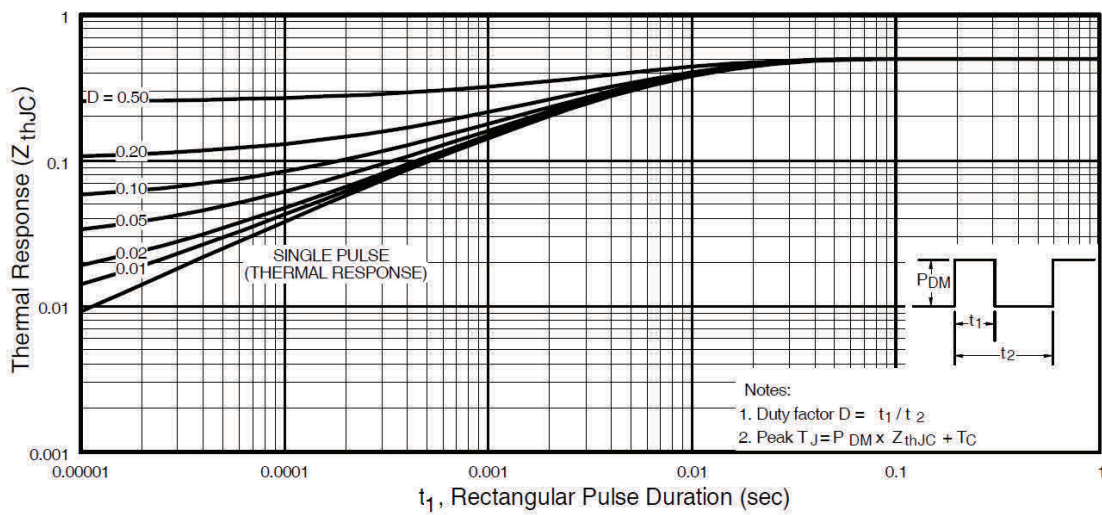

Fig 9. Maximum Effective Transient Thermal Impedance, Junction-to-Case, MOSFET

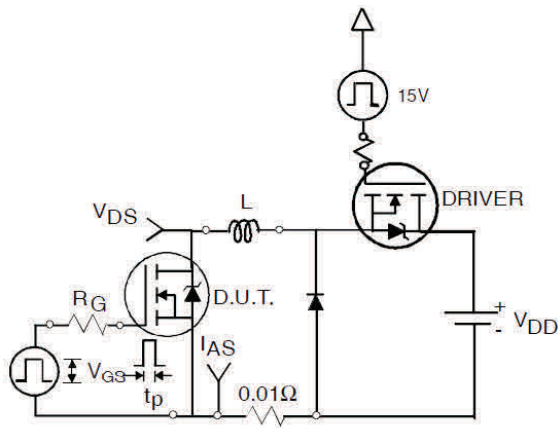

Fig 10a. Unclamped Inductive Test Circuit

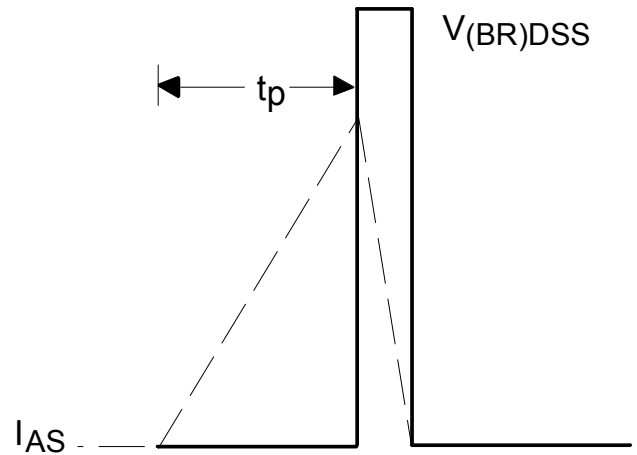

Fig 10b. Unclamped Inductive Waveforms

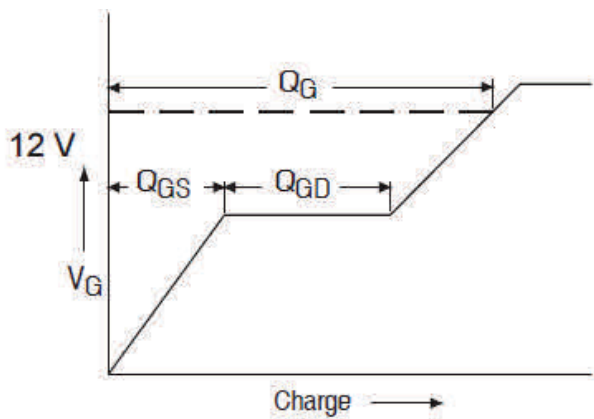

Fig 11a. Gate Charge Waveform

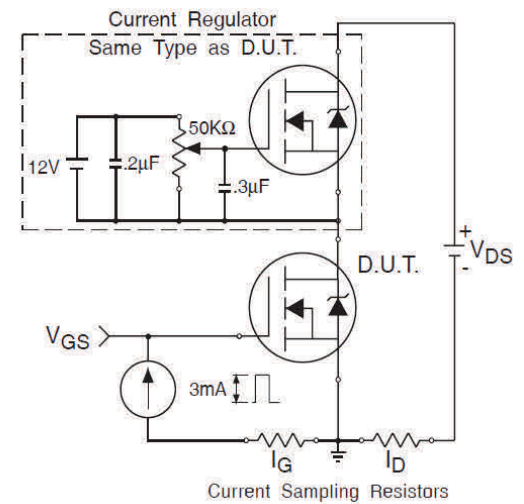

Fig 11b. Gate Charge Test Circuit

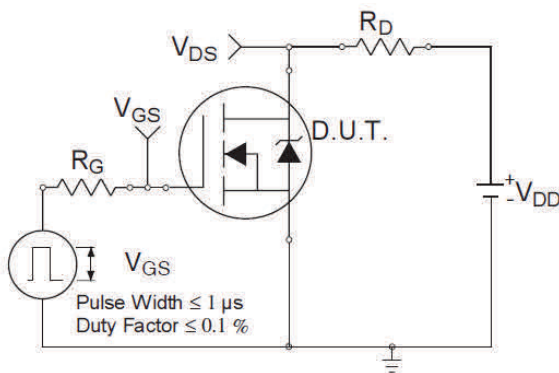

Fig 12a. Switching Time Test Circuit

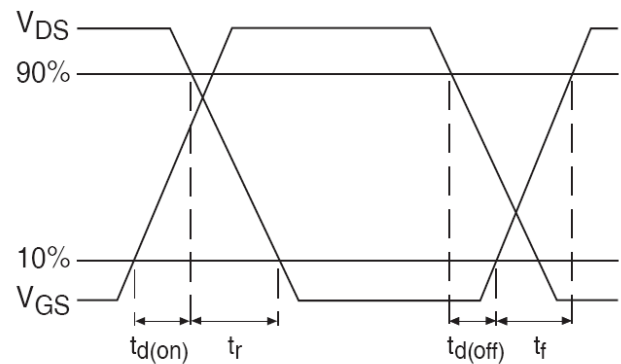

Fig 12b. Switching Time Waveforms

MOSFET Body Diode & Schottky Diode Characteristics

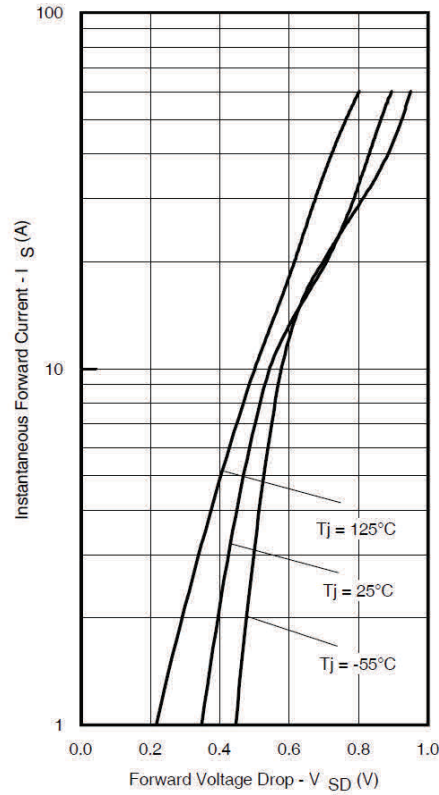

Fig 13. Typical Forward Voltage Drop Characteristics

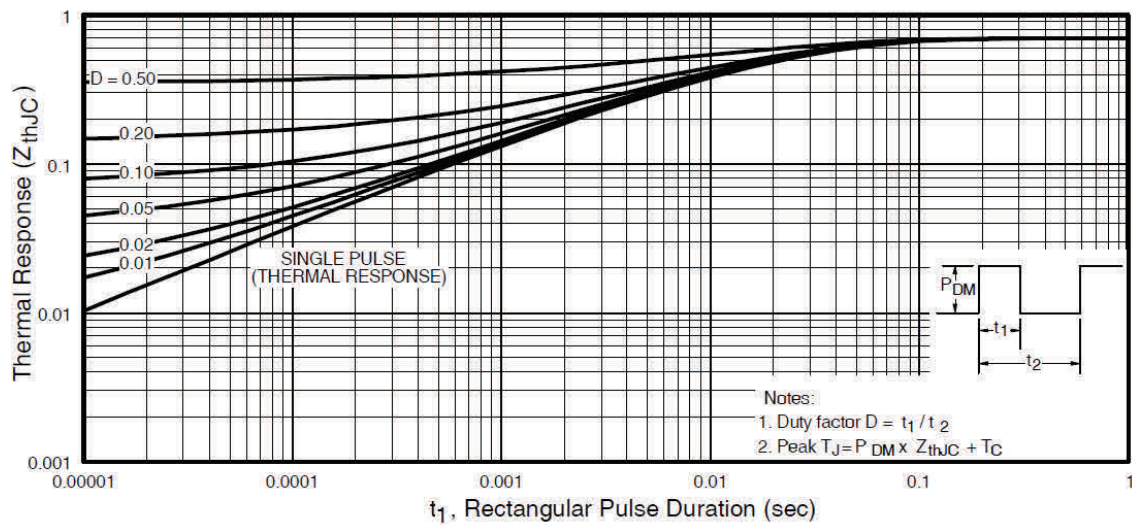
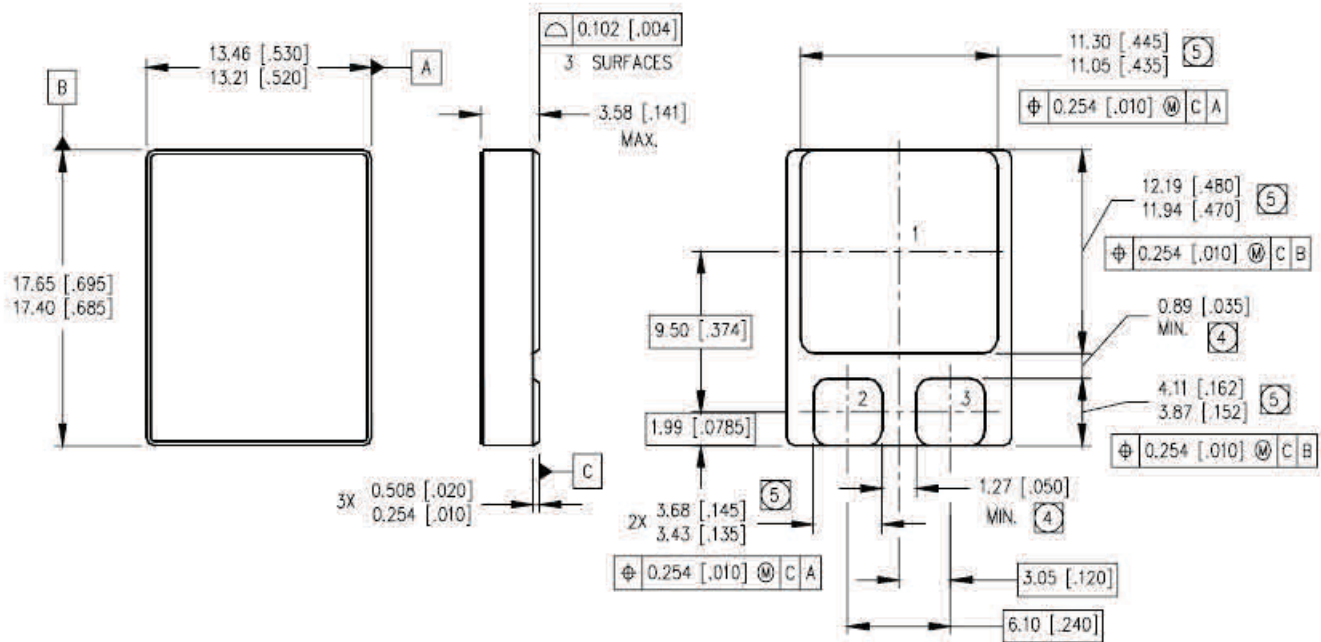

Fig 14. Maximum Effective Transient Thermal Impedance, Junction-to-Case , Schottky

Case Outline and Dimensions — SMD-2



NOTES:

1. DIMENSIONING & TOLERANCING PER ASME Y14.5M-1994.
2. CONTROLLING DIMENSION; INCH.
3. DIMENSIONS ARE SHOWN IN MILLIMETERS [INCHES].
4. DIMENSION INCLUDES METALLIZATION FLASH.
5. DIMENSION DOES NOT INCLUDE METALLIZATION FLASH.

PAD ASSIGNMENTS

- 1 = DRAIN
- 2 = GATE
- 3 = SOURCE

IMPORTANT NOTICE

The information given in this document shall be in no event regarded as guarantee of conditions or characteristic. The data contained herein is a characterization of the component based on internal standards and is intended to demonstrate and provide guidance for typical part performance. It will require further evaluation, qualification and analysis to determine suitability in the application environment to confirm compliance to your system requirements.

With respect to any example hints or any typical values stated herein and/or any information regarding the application of the product, Infineon Technologies hereby disclaims any and all warranties and liabilities of any kind including without limitation warranties on non- infringement of intellectual property rights and any third party.

In addition, any information given in this document is subject to customer's compliance with its obligations stated in this document and any applicable legal requirements, norms and standards concerning customer's product and any use of the product of Infineon Technologies in customer's applications.

The data contained in this document is exclusively intended for technically trained staff. It is the responsibility of any customer's technical departments to evaluate the suitability of the product for the intended applications and the completeness of the product information given in this document with respect to applications.

For further information on the product, technology, delivery terms and conditions and prices, please contact your local sales representative or go to (www.infineon.com/hirel).

WARNING

Due to technical requirements products may contain dangerous substances. For information on the types in question, please contact your nearest Infineon Technologies office.

单击下面可查看定价，库存，交付和生命周期等信息

[>>Infineon Technologies\(英飞凌\)](#)