

MOSFET

Metal Oxide Semiconductor Field Effect Transistor

CoolMOS™ CE

800V CoolMOS™ CE Power Transistor
IPx80R2K8CE

Data Sheet

Rev. 2.2
Final

1 Description

CoolMOS™ CE is a revolutionary technology for high voltage power MOSFETs. The high voltage capability combines safety with performance and ruggedness to allow stable designs at highest efficiency level. CoolMOS™ 800V CE comes with a selected package choice offering the benefit of reduced system costs and higher power density designs.

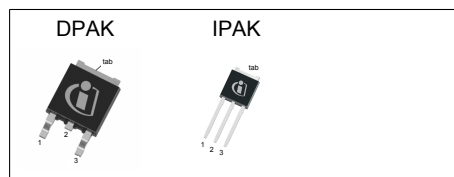

Features ¹⁾

- High voltage technology
- Extreme dv/dt rated
- High peak current capability
- Low gate charge
- Low effective capacitances
- Qualified for industrial grade applications according to JEDEC (J-STD20 and JESD22)
- Pb-free lead plating; RoHS compliant; halogen free mold compound

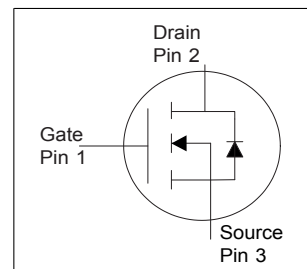

Benefits

- Increased power density solutions due to smaller package
- System cost / size savings due to reduced cooling requirements
- Higher system reliability due to low operating temperatures



Applications

- LED Lighting for retrofit applications in QR Flyback topology

Table 1 Key Performance Parameters

Parameter	Value	Unit
$V_{DS} @ T_j=25^{\circ}C$	800	V
$R_{DS(on),max}$	2.8	Ω
$Q_{g,typ}$	12	nC
$I_{D,pulse}$	6	A
$V_{GS(th),typ}$	3	V
$C_{O(tr),typ}$	26	pF

Type / Ordering Code	Package	Marking	Related Links
IPD80R2K8CE	PG-TO 252	8R2K8CE	see Appendix A
IPU80R2K8CE	PG-TO 251		



Table of Contents

Description 2

Maximum ratings 4

Thermal characteristics 4

Electrical characteristics 5

Electrical characteristics diagrams 7

Test Circuits 11

Package Outlines 12

Appendix A 14

Revision History 15

Disclaimer 15

2 Maximum ratings

at $T_j = 25^\circ\text{C}$, unless otherwise specified

Table 2 Maximum ratings

Parameter	Symbol	Values			Unit	Note / Test Condition
		Min.	Typ.	Max.		
Continuous drain current ¹⁾	I_D	-	-	1.9 1.1	A	$T_C = 25^\circ\text{C}$ $T_C = 100^\circ\text{C}$
Pulsed drain current ²⁾	$I_{D,pulse}$	-	-	6	A	$T_C = 25^\circ\text{C}$
Avalanche energy, single pulse	E_{AS}	-	-	90	mJ	$I_D = 1\text{A}; V_{DD} = 50\text{V}$
Avalanche energy, repetitive	E_{AR}	-	-	0.05	mJ	$I_D = 1\text{A}; V_{DD} = 50\text{V}$
Avalanche current, repetitive	I_{AR}	-	-	1	A	-
MOSFET dv/dt ruggedness	dv/dt	-	-	50	V/ns	$V_{DS} = 0 \dots 640\text{V}$
Gate source voltage	V_{GS}	-20 -30	-	20 30	V	static; AC ($f > 1\text{ Hz}$)
Power dissipation (non FullPAK) TO-252, TO-251	P_{tot}	-	-	42	W	$T_C = 25^\circ\text{C}$
Operating and storage temperature	T_j, T_{stg}	-55	-	150	$^\circ\text{C}$	-
Continuous diode forward current	I_S	-	-	1.9	A	$T_C = 25^\circ\text{C}$
Diode pulse current ²⁾	$I_{S,pulse}$	-	-	6	A	$T_C = 25^\circ\text{C}$
Reverse diode dv/dt ³⁾	dv/dt	-	-	4	V/ns	$V_{DS} = 0 \dots 400\text{V}, I_{SD} \leq I_S, T_j = 25^\circ\text{C}$
Maximum diode commutation speed	di/dt	-	-	400	A/ μs	$V_{DS} = 0 \dots 400\text{V}, I_{SD} \leq I_S, T_j = 25^\circ\text{C}$

3 Thermal characteristics

Table 3 Thermal characteristics DPAK, IPAK

Parameter	Symbol	Values			Unit	Note / Test Condition
		Min.	Typ.	Max.		
Thermal resistance, junction - case	R_{thJC}	-	-	3	$^\circ\text{C}/\text{W}$	-
Thermal resistance, junction - ambient ⁴⁾	R_{thJA}	-	- 35	62 -	$^\circ\text{C}/\text{W}$	SMD version, device on PCB, minimal footprint SMD version, device on PCB, 6cm ² cooling area ⁴⁾
Soldering temperature, wave- & reflowsoldering allowed	T_{sold}	-	-	260	$^\circ\text{C}$	reflow MSL 1

¹⁾ Limited by $T_{j,max}$.

²⁾ Pulse width t_p limited by $T_{j,max}$.

³⁾ Identical low side and high side switch with identical R_G .

⁴⁾ Device on 40mm*40mm*1.5mm one layer epoxy PCB FR4 with 6cm² copper area (thickness 70 μm) for drain connection. PCB is vertical without air stream cooling.

4 Electrical characteristics

Table 4 Static characteristics

Parameter	Symbol	Values			Unit	Note / Test Condition
		Min.	Typ.	Max.		
Drain-source breakdown voltage	$V_{(BR)DSS}$	800	-	-	V	$V_{GS}=0V, I_D=0.25mA$
Gate threshold voltage	$V_{(GS)th}$	2.1	3	3.9	V	$V_{DS}=V_{GS}, I_D=0.12mA$
Zero gate voltage drain current	I_{DSS}	-	-	5	μA	$V_{DS}=800V, V_{GS}=0V, T_j=25^\circ C$ $V_{DS}=800V, V_{GS}=0V, T_j=150^\circ C$
Gate-source leakage current	I_{GSS}	-	-	100	nA	$V_{GS}=20V, V_{DS}=0V$
Drain-source on-state resistance	$R_{DS(on)}$	-	2.4 6.5	2.8	Ω	$V_{GS}=10V, I_D=1.1A, T_j=25^\circ C$ $V_{GS}=10V, I_D=1.1A, T_j=150^\circ C$
Gate resistance	R_G	-	1.2	-	Ω	$f=1\text{ MHz}, \text{open drain}$

Table 5 Dynamic characteristics

Parameter	Symbol	Values			Unit	Note / Test Condition
		Min.	Typ.	Max.		
Input capacitance	C_{iss}	-	290	-	pF	$V_{GS}=0V, V_{DS}=100V, f=1MHz$
Output capacitance	C_{oss}	-	13	-	pF	$V_{GS}=0V, V_{DS}=100V, f=1MHz$
Effective output capacitance, energy related ¹⁾	$C_{o(er)}$	-	11	-	pF	$V_{GS}=0V, V_{DS}=0\dots 480V$
Effective output capacitance, time related ²⁾	$C_{o(tr)}$	-	26	-	pF	$I_D=\text{constant}, V_{GS}=0V, V_{DS}=0\dots 480V$
Turn-on delay time	$t_{d(on)}$	-	25	-	ns	$V_{DD}=400V, V_{GS}=0/10V, I_D=1.9A, R_G=47\Omega$
Rise time	t_r	-	15	-	ns	$V_{DD}=400V, V_{GS}=0/10V, I_D=1.9A, R_G=47\Omega$
Turn-off delay time	$t_{d(off)}$	-	72	-	ns	$V_{DD}=400V, V_{GS}=0/10V, I_D=1.9A, R_G=47\Omega$
Fall time	t_f	-	18	-	ns	$V_{DD}=400V, V_{GS}=10\text{ V}, I_D=1.9A, R_G=47\Omega$

Table 6 Gate charge characteristics

Parameter	Symbol	Values			Unit	Note / Test Condition
		Min.	Typ.	Max.		
Gate to source charge	Q_{gs}	-	1.5	-	nC	$V_{DD}=640V, I_D=1.9A, V_{GS}=0\text{ to }10V$
Gate to drain charge	Q_{gd}	-	6	-	nC	$V_{DD}=640V, I_D=1.9A, V_{GS}=0\text{ to }10V$
Gate charge total	Q_g	-	12	-	nC	$V_{DD}=640V, I_D=1.9A, V_{GS}=0\text{ to }10V$
Gate plateau voltage	$V_{plateau}$	-	5.5	-	V	$V_{DD}=640V, I_D=1.9A, V_{GS}=0\text{ to }10V$

¹⁾ $C_{o(er)}$ is a fixed capacitance that gives the same stored energy as C_{oss} while V_{DS} is rising from 0 to 80% $V_{(BR)DSS}$

²⁾ $C_{o(tr)}$ is a fixed capacitance that gives the same charging time as C_{oss} while V_{DS} is rising from 0 to 80% $V_{(BR)DSS}$

Table 7 Reverse diode characteristics

Parameter	Symbol	Values			Unit	Note / Test Condition
		Min.	Typ.	Max.		
Diode forward voltage	V_{SD}	-	1	1.2	V	$V_{GS}=0V, I_F=1.9A, T_j=25^\circ C$
Reverse recovery time	t_{rr}	-	520	-	ns	$V_R=400V, I_F=1.9A, di_F/dt=100A/\mu s$
Reverse recovery charge	Q_{rr}	-	2	-	μC	$V_R=400V, I_F=1.9A, di_F/dt=100A/\mu s$
Peak reverse recovery current	I_{rrm}	-	6	-	A	$V_R=400V, I_F=1.9A, di_F/dt=100A/\mu s$

5 Electrical characteristics diagrams

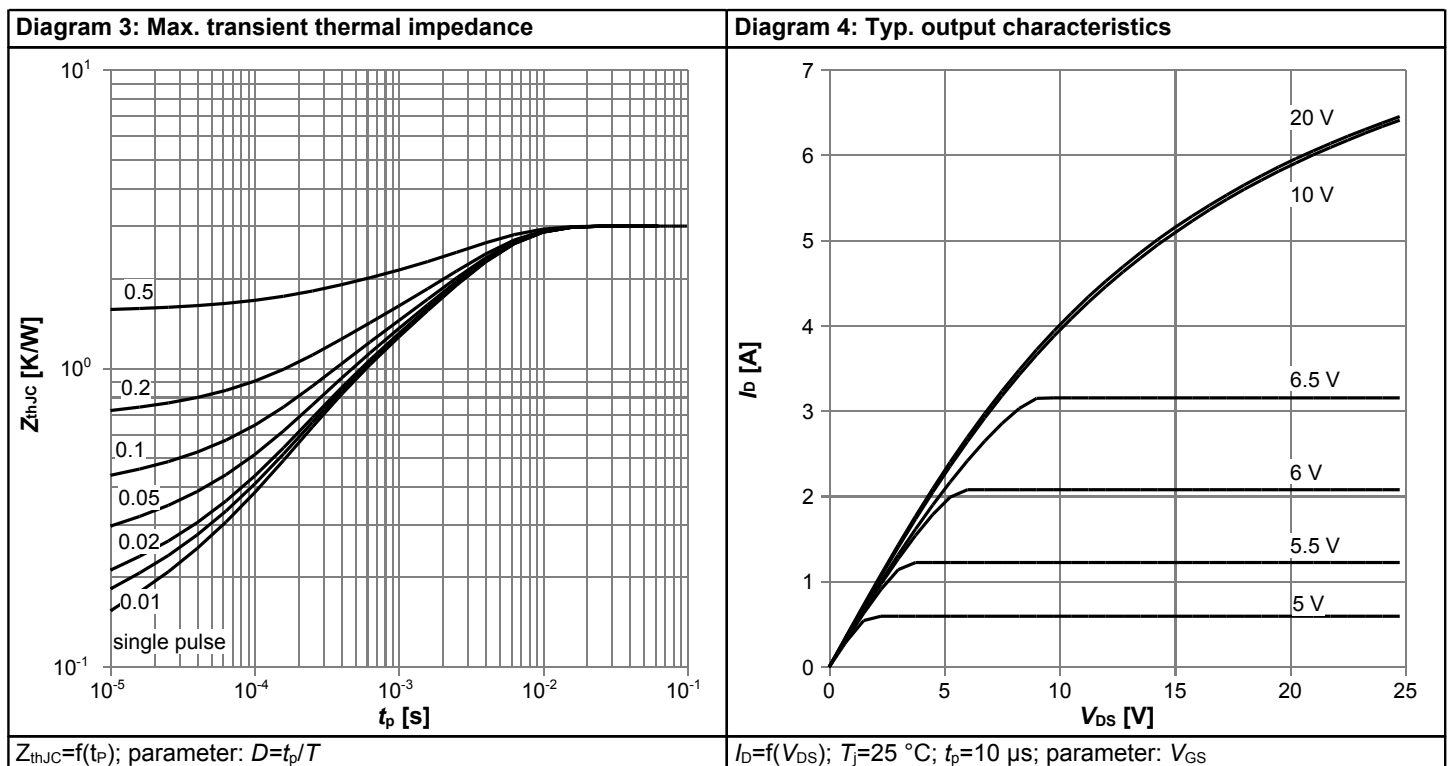
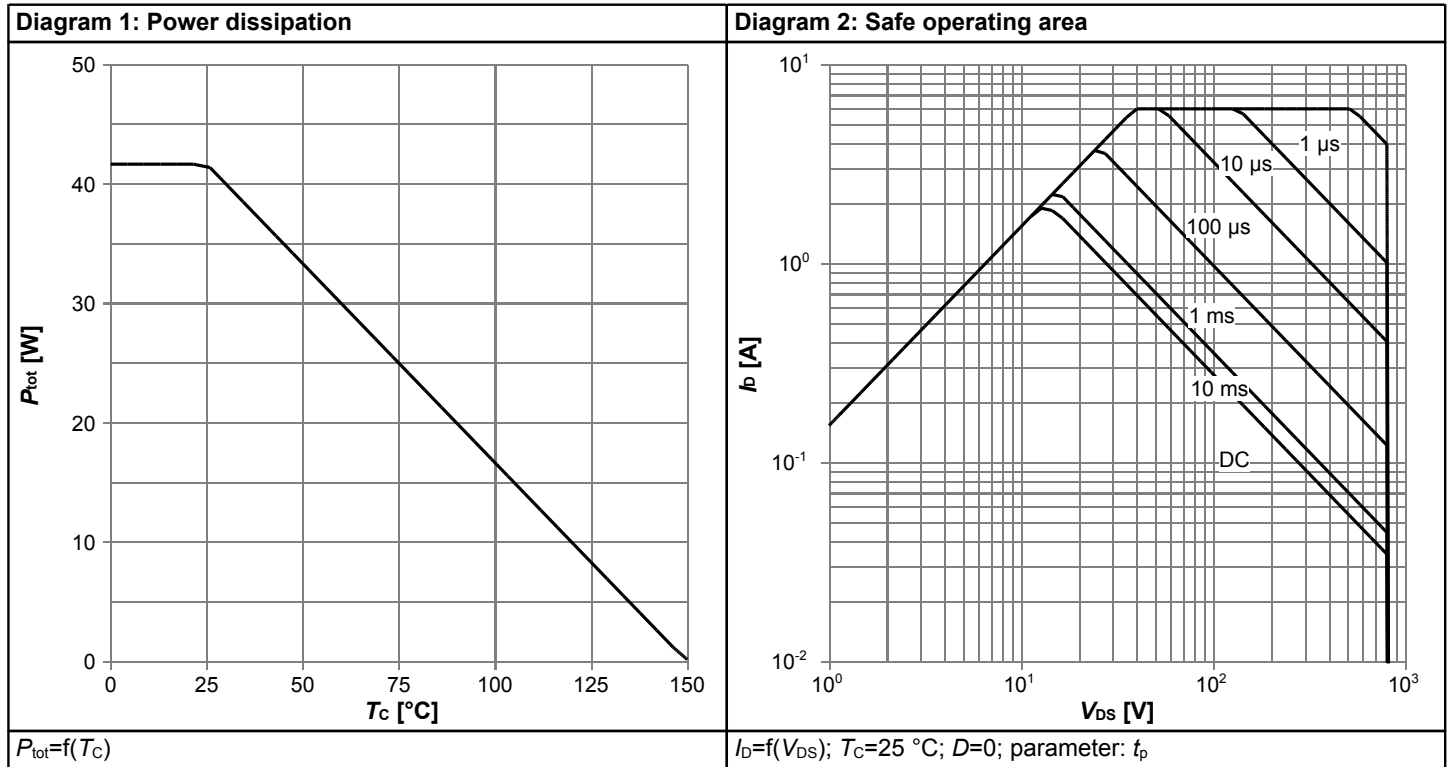
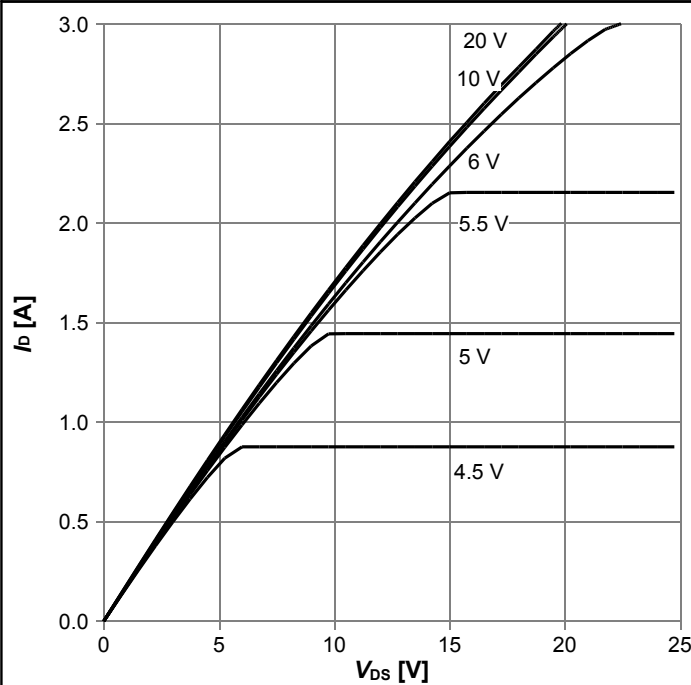
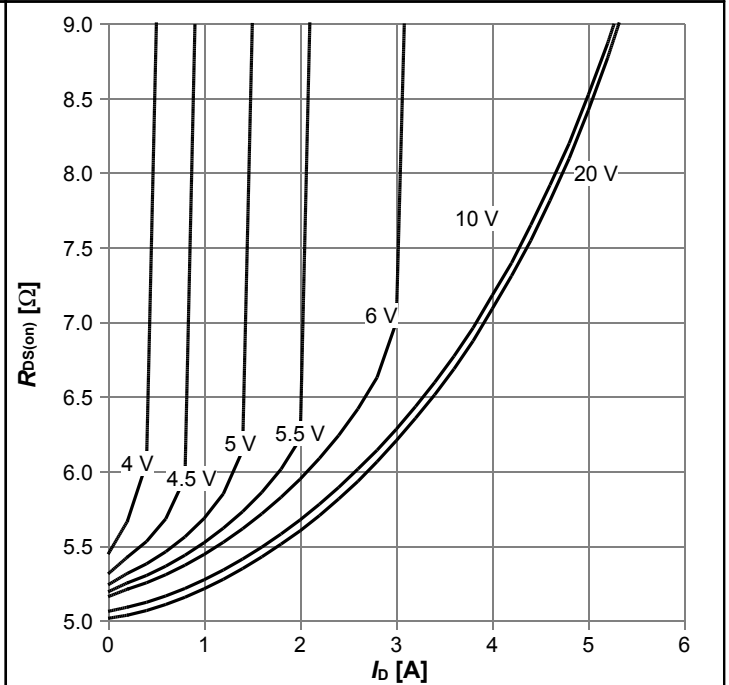

Diagram 5: Typ. output characteristics



$I_D = f(V_{DS})$; $T_j = 150\text{ }^\circ\text{C}$; $t_p = 10\text{ }\mu\text{s}$; parameter: V_{GS}

Diagram 6: Typ. drain-source on-state resistance



$R_{DS(on)} = f(I_D)$; $T_j = 150\text{ }^\circ\text{C}$; parameter: V_{GS}

Diagram 7: Drain-source on-state resistance

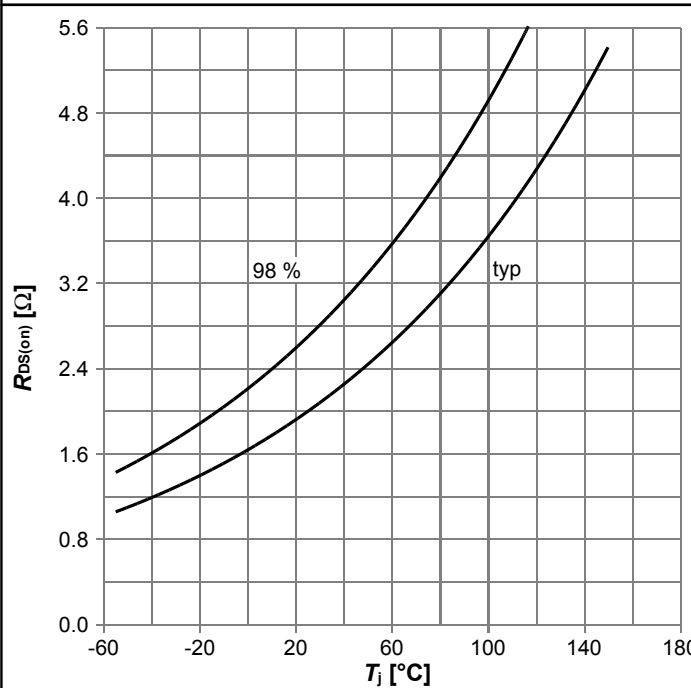

$R_{DS(on)} = f(T_j)$; $I_D = 1.1\text{ A}$; $V_{GS} = 10\text{ V}$

Diagram 8: Typ. transfer characteristics

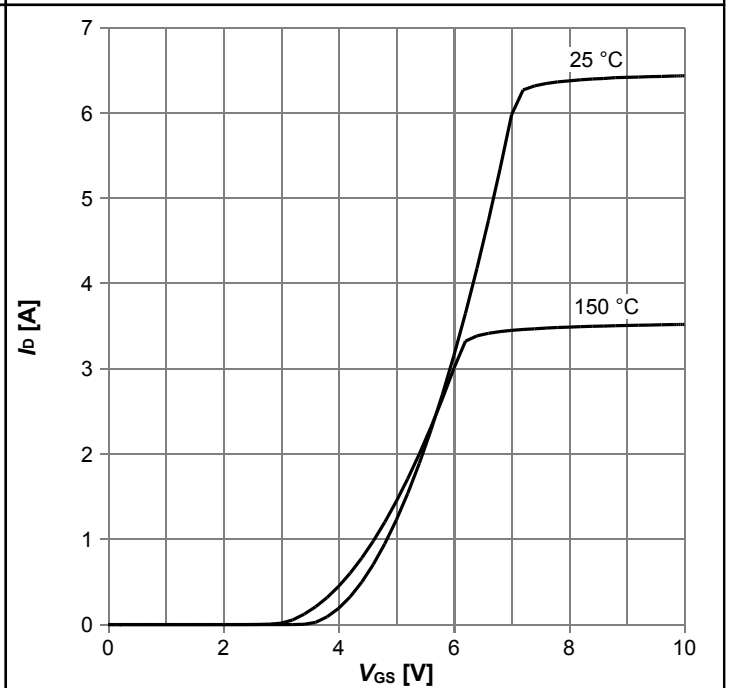

$I_D = f(V_{GS})$; $|V_{DS}| > 2|I_D|R_{DS(on)max}$; $t_p = 10\text{ }\mu\text{s}$; parameter: T_j

Diagram 9: Typ. gate charge

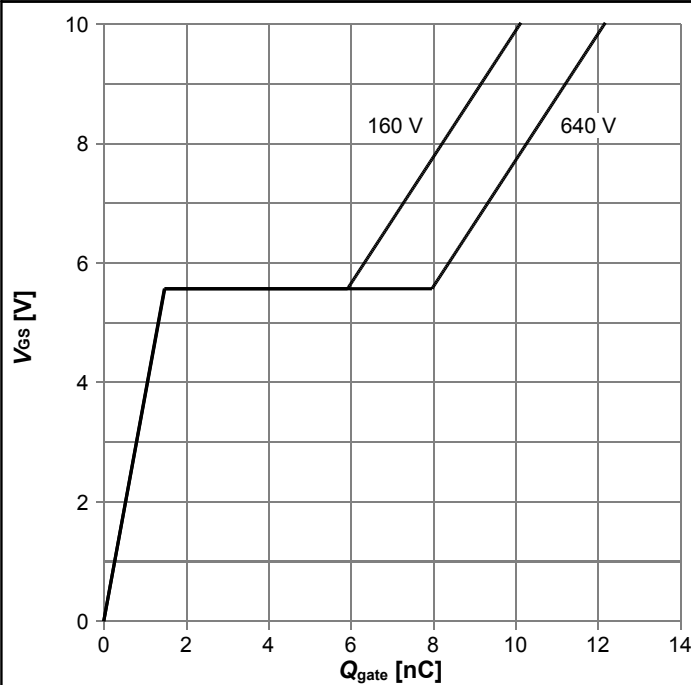

$V_{GS}=f(Q_{gate}); I_D=1.9\text{ A pulsed}; \text{parameter: } V_{DD}$

Diagram 10: Forward characteristics of reverse diode

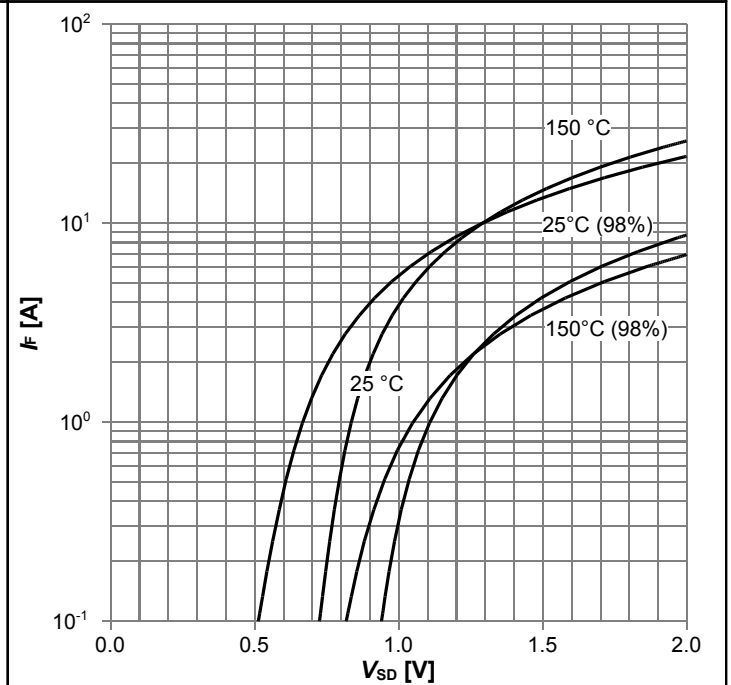

$I_F=f(V_{SD}); t_p=10\ \mu\text{s}; \text{parameter: } T_j$

Diagram 11: Avalanche energy

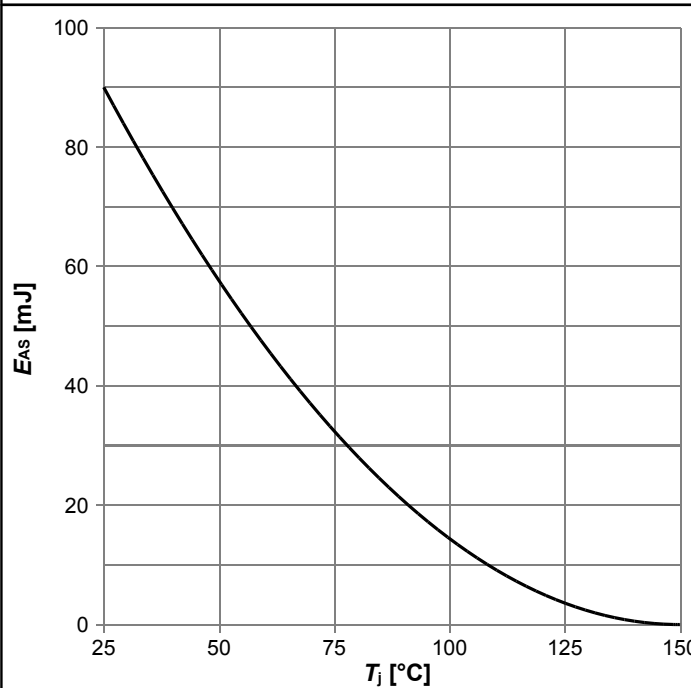

$E_{AS}=f(T_j); I_D=1\text{ A}; V_{DD}=50\text{ V}$

Diagram 12: Drain-source breakdown voltage

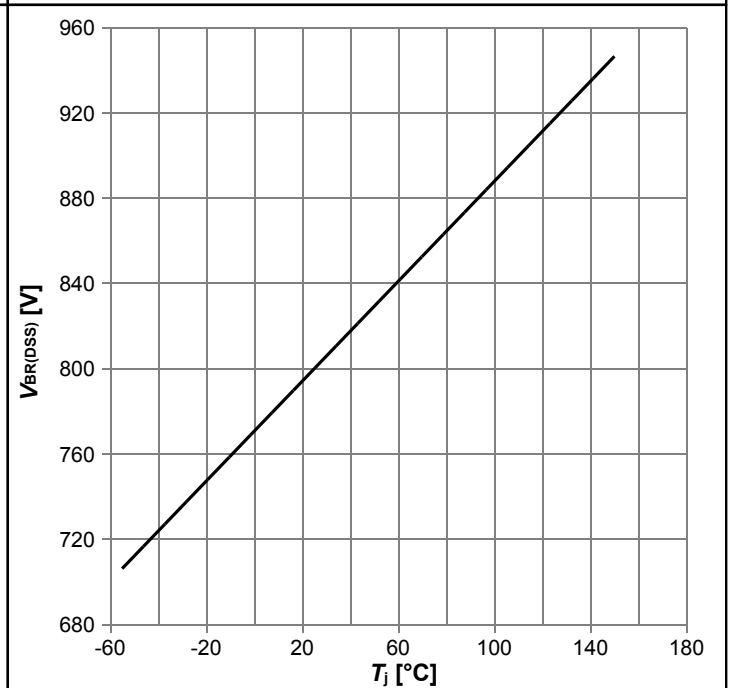

$V_{BR(DSS)}=f(T_j); I_D=0.25\text{ mA}$

Diagram 13: Typ. capacitances

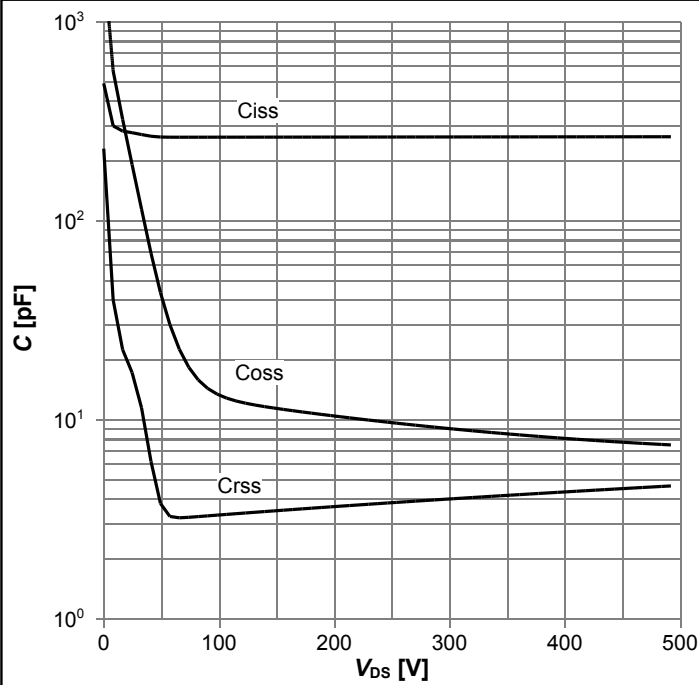

$C=f(V_{DS}); V_{GS}=0\text{ V}; f=1\text{ MHz}$

Diagram 14: Typ. Coss stored energy

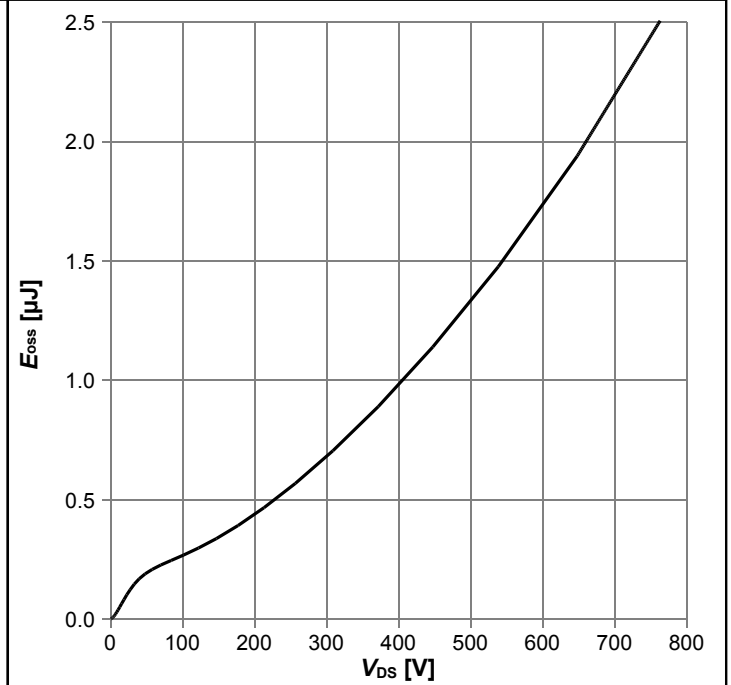

$E_{oss}=f(V_{DS})$

6 Test Circuits

Table 8 Diode characteristics

Test circuit for diode characteristics	Diode recovery waveform

Table 9 Switching times

Switching times test circuit for inductive load	Switching times waveform

Table 10 Unclamped inductive load

Unclamped inductive load test circuit	Unclamped inductive waveform

7 Package Outlines

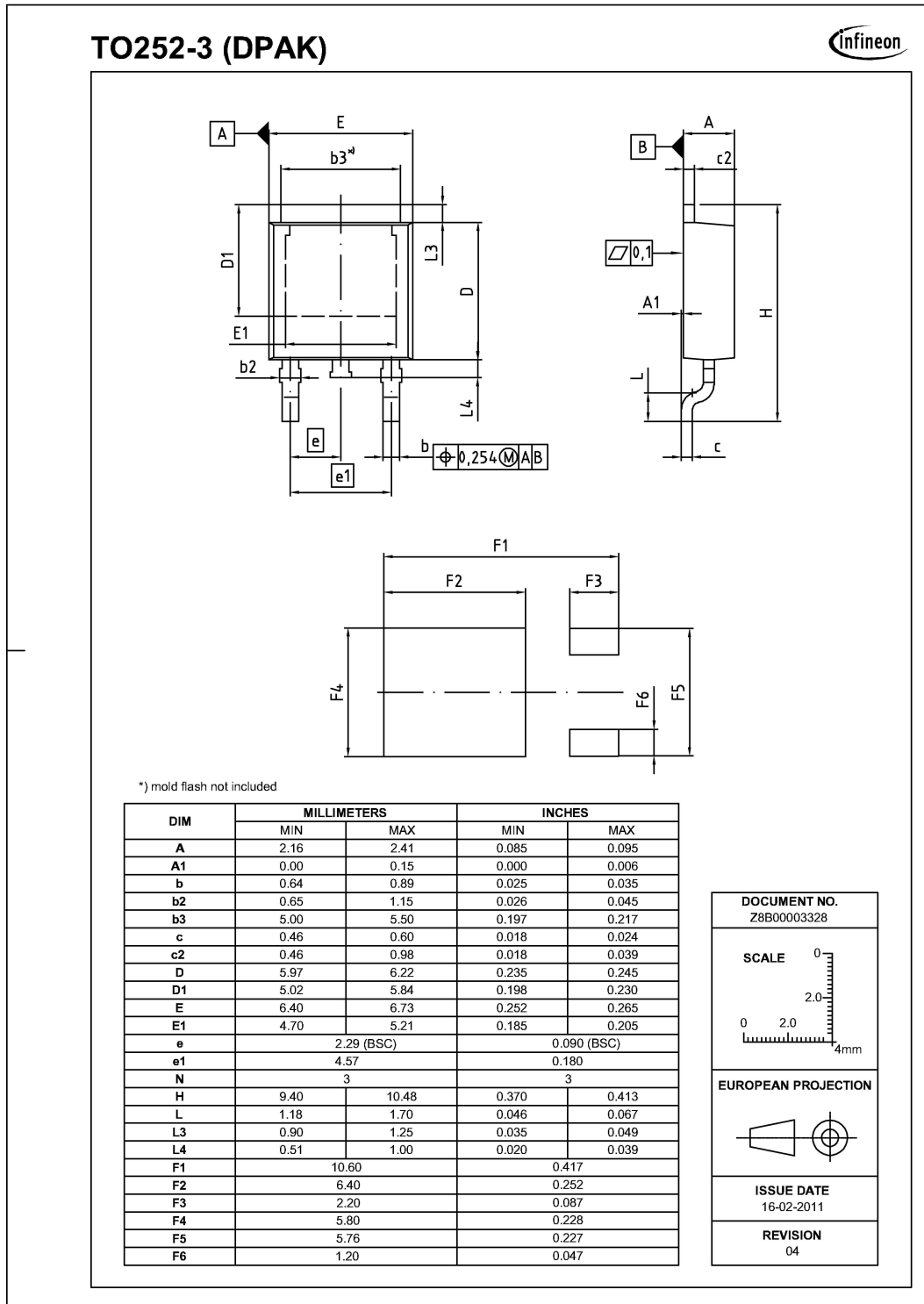
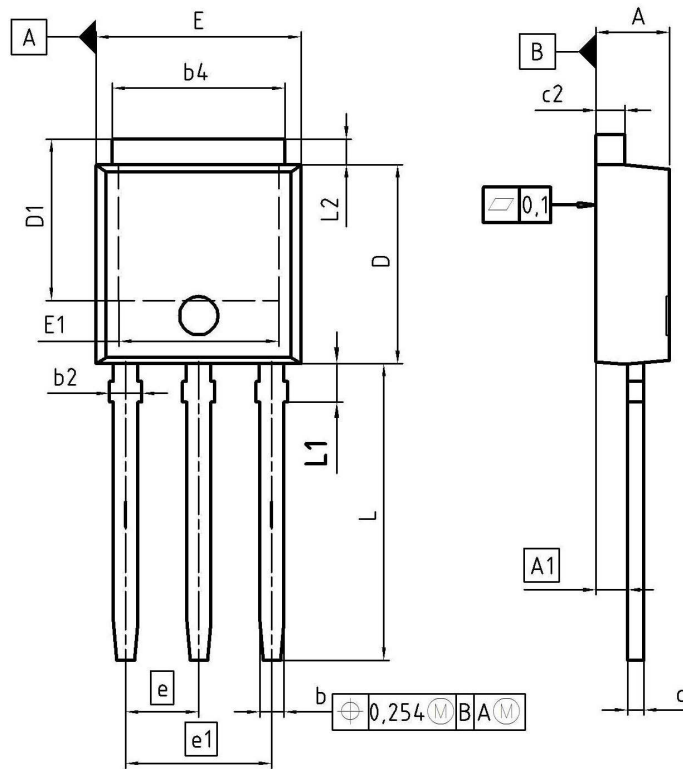

Figure 1 Outline PG-TO 252, dimensions in mm/inches



DIM	MILLIMETERS		INCHES	
	MIN	MAX	MIN	MAX
A	2.16	2.41	0.085	0.095
A1	0.90	1.14	0.035	0.045
b	0.64	0.89	0.025	0.035
b2	0.65	1.15	0.026	0.045
b4	4.95	5.50	0.195	0.217
c	0.46	0.60	0.018	0.024
c2	0.46	0.89	0.018	0.035
D	5.97	6.22	0.235	0.245
D1	5.04	5.77	0.198	0.227
E	6.35	6.73	0.250	0.265
E1	4.70	5.21	0.185	0.205
e	2.29		0.090	
e1	4.57		0.180	
N	3		3	
L	8.89	9.65	0.350	0.380
L1	1.90	2.29	0.075	0.090
L2	0.89	1.37	0.035	0.054

DOCUMENT NO.
Z8B00003330

SCALE

EUROPEAN PROJECTION

ISSUE DATE
19-03-2008

REVISION
03

Figure 2 Outline PG-TO 251, dimensions in mm/inches

8 Appendix A

Table 11 Related Links

- IFX CoolMOS Webpage: www.infineon.com
- IFX Design tools: www.infineon.com

Revision History

IPx80R2K8CE

Revision: 2016-04-27, Rev. 2.2

Previous Revision

Revision	Date	Subjects (major changes since last revision)
2.0	2013-06-24	Release of final version
2.1	2013-07-18	update to halogen free mold compound
2.2	2016-04-27	Non-halogen free version discontinued

Trademarks of Infineon Technologies AG

AURIX™, C166™, CanPAK™, CIPOS™, CoolGaN™, CoolMOS™, CoolSET™, CoolSiC™, CORECONTROL™, CROSSAVE™, DAVE™, DI-POL™, DrBlade™, EasyPIM™, EconoBRIDGE™, EconoDUAL™, EconoPACK™, EconoPIM™, EiceDRIVER™, eupec™, FCOS™, HITFET™, HybridPACK™, Infineon™, ISOFACE™, IsoPACK™, i-Wafer™, MIPAQ™, ModSTACK™, my-d™, NovalithIC™, OmniTune™, OPTIGA™, OptiMOS™, ORIGA™, POWERCODE™, PRIMARION™, PrimePACK™, PrimeSTACK™, PROFET™, PRO-SIL™, RASIC™, REAL3™, ReverSave™, SatRIC™, SIEGET™, SiPMOS™, SmartLEWIS™, SOLID FLASH™, SPOC™, TEMPFET™, thinQ!™, TRENCHSTOP™, TriCore™.

Trademarks updated August 2015

Other Trademarks

All referenced product or service names and trademarks are the property of their respective owners.

We Listen to Your Comments

Any information within this document that you feel is wrong, unclear or missing at all? Your feedback will help us to continuously improve the quality of this document. Please send your proposal (including a reference to this document) to: erratum@infineon.com

Published by
Infineon Technologies AG
81726 München, Germany
© 2016 Infineon Technologies AG
All Rights Reserved.

Legal Disclaimer

The information given in this document shall in no event be regarded as a guarantee of conditions or characteristics. With respect to any examples or hints given herein, any typical values stated herein and/or any information regarding the application of the device, Infineon Technologies hereby disclaims any and all warranties and liabilities of any kind, including without limitation, warranties of non-infringement of intellectual property rights of any third party.

Information

For further information on technology, delivery terms and conditions and prices please contact your nearest Infineon Technologies Office (www.infineon.com).

Warnings

Due to technical requirements, components may contain dangerous substances. For information on the types in question, please contact the nearest Infineon Technologies Office.

The Infineon Technologies component described in this Data Sheet may be used in life-support devices or systems and/or automotive, aviation and aerospace applications or systems only with the express written approval of Infineon Technologies, if a failure of such components can reasonably be expected to cause the failure of that life-support, automotive, aviation and aerospace device or system or to affect the safety or effectiveness of that device or system. Life support devices or systems are intended to be implanted in the human body or to support and/or maintain and sustain and/or protect human life. If they fail, it is reasonable to assume that the health of the user or other persons may be endangered.

单击下面可查看定价，库存，交付和生命周期等信息

[>>Infineon Technologies\(英飞凌\)](#)

[>>点击查看相关商品](#)