

## MOSFET

### 650V CoolMOS™ CE Power Transistor

CoolMOS™ is a revolutionary technology for high voltage power MOSFETs, designed according to the superjunction (SJ) principle and pioneered by Infineon Technologies. CoolMOS™ CE series combines the experience of the leading SJ MOSFET supplier with high class innovation. The resulting devices provide all benefits of a fast switching Superjunction MOSFET while not sacrificing ease of use. Extremely low switching and conduction losses make switching applications even more efficient, more compact, lighter and cooler.

#### Features

- Extremely low losses due to very low FOM  $R_{DS(on)} \cdot Q_g$  and Eoss
- Very high commutation ruggedness
- Easy to use/drive
- JEDEC qualified, Pb-free plating, Halogen free mold compound
- Qualified for standard grade applications

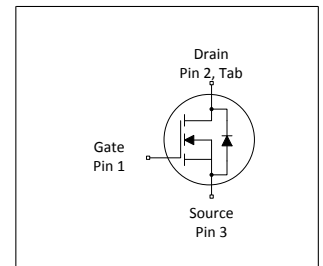
#### Applications

PFC stages, hard switching PWM stages and resonant switching stages for e.g. PC Silverbox, Adapter, LCD & PDP TV and indoor Lighting

*Please note: For MOSFET paralleling the use of ferrite beads on the gate or separate totem poles is generally recommended.*



PG-TO 220 FP



**Table 1 Key Performance Parameters**

Parameter	Value	Unit
$V_{DS} @ T_{j,max}$	700	V
$R_{DS(on),max}$	400	$m\Omega$
$I_D$	15.1	A
$Q_{g,typ}$	39	nC
$I_{D,pulse}$	30	A
$E_{oss@400V}$	2.8	$\mu J$

Type / Ordering Code	Package	Marking	Related Links
IPA65R400CE	PG-TO 220 FullPAK	65S400CE	see Appendix A

## Table of Contents

Description .....	1
Maximum ratings .....	3
Thermal characteristics .....	4
Electrical characteristics .....	5
Electrical characteristics diagrams .....	7
Test Circuits .....	11
Package Outlines .....	12
Appendix A .....	13
Revision History .....	14
Trademarks .....	14
Disclaimer .....	14

## 1 Maximum ratings

at  $T_j = 25^\circ\text{C}$ , unless otherwise specified

**Table 2 Maximum ratings**

Parameter	Symbol	Values			Unit	Note / Test Condition
		Min.	Typ.	Max.		
Continuous drain current <sup>1)</sup>	$I_D$	-	-	15.1 9.5	A	$T_C=25^\circ\text{C}$ $T_C=100^\circ\text{C}$
Pulsed drain current <sup>2)</sup>	$I_{D,pulse}$	-	-	30	A	$T_C=25^\circ\text{C}$
Avalanche energy, single pulse	$E_{AS}$	-	-	215	mJ	$I_D=1.8\text{A}$ ; $V_{DD}=50\text{V}$ ; see table 10
Avalanche energy, repetitive	$E_{AR}$	-	-	0.32	mJ	$I_D=1.8\text{A}$ ; $V_{DD}=50\text{V}$ ; see table 10
Avalanche current, repetitive	$I_{AR}$	-	-	1.8	A	-
MOSFET dv/dt ruggedness	dv/dt	-	-	50	V/ns	$V_{DS}=0\dots480\text{V}$
Gate source voltage (static)	$V_{GS}$	-20	-	20	V	static;
Gate source voltage (dynamic)	$V_{GS}$	-30	-	30	V	AC ( $f>1\text{ Hz}$ )
Power dissipation (Non FullPAK) TO-252, TO-251	$P_{tot}$	-	-	118	W	$T_C=25^\circ\text{C}$
Power dissipation (FullPAK) TO-220FP	$P_{tot}$	-	-	31	W	$T_C=25^\circ\text{C}$
Storage temperature	$T_{stg}$	-55	-	150	$^\circ\text{C}$	-
Operating junction temperature	$T_j$	-55	-	150	$^\circ\text{C}$	-
Continuous diode forward current	$I_S$	-	-	10.6	A	$T_C=25^\circ\text{C}$
Diode pulse current <sup>2)</sup>	$I_{S,pulse}$	-	-	30	A	$T_C=25^\circ\text{C}$
Reverse diode dv/dt <sup>3)</sup>	dv/dt	-	-	15	V/ns	$V_{DS}=0\dots400\text{V}$ , $I_{SD}\leq I_S$ , $T_j=25^\circ\text{C}$ see table 8
Maximum diode commutation speed	di/dt	-	-	500	A/ $\mu\text{s}$	$V_{DS}=0\dots400\text{V}$ , $I_{SD}\leq I_S$ , $T_j=25^\circ\text{C}$ see table 8
Mounting torque (FullPAK) TO-220FP	-	-	-	50	Ncm	M2.5 screws
Insulation withstand voltage for TO-220FP	$V_{ISO}$	-	-	2500	V	$V_{rms}$ , $T_C=25^\circ\text{C}$ , $t=1\text{min}$

<sup>1)</sup> Limited by  $T_{j,max}$ . TO251 equivalent, Maximum duty cycle  $D=0.5$

<sup>2)</sup> Pulse width  $t_p$  limited by  $T_{j,max}$

<sup>3)</sup> Identical low side and high side switch with identical  $R_\theta$

## 2 Thermal characteristics

**Table 3 Thermal characteristics (FullPAK) TO-220FP**

Parameter	Symbol	Values			Unit	Note / Test Condition
		Min.	Typ.	Max.		
Thermal resistance, junction - case	$R_{thJC}$	-	-	4	°C/W	-
Thermal resistance, junction - ambient	$R_{thJA}$	-	-	80	°C/W	leaded
Soldering temperature, wavesoldering only allowed at leads	$T_{sold}$	-	-	260	°C	1.6mm (0.063 in.) from case for 10s

### 3 Electrical characteristics

at  $T_j=25^\circ\text{C}$ , unless otherwise specified

**Table 4 Static characteristics**

Parameter	Symbol	Values			Unit	Note / Test Condition
		Min.	Typ.	Max.		
Drain-source breakdown voltage	$V_{(BR)DSS}$	650	-	-	V	$V_{GS}=0V, I_D=1mA$
Gate threshold voltage	$V_{(GS)th}$	2.5	3.0	3.5	V	$V_{DS}=V_{GS}, I_D=0.32mA$
Zero gate voltage drain current	$I_{DSS}$	-	-	1	$\mu\text{A}$	$V_{DS}=650, V_{GS}=0V, T_j=25^\circ\text{C}$ $V_{DS}=650, V_{GS}=0V, T_j=150^\circ\text{C}$
Gate-source leakage current	$I_{GSS}$	-	-	100	nA	$V_{GS}=20V, V_{DS}=0V$
Drain-source on-state resistance	$R_{DS(on)}$	-	0.36 0.94	0.40 -	$\Omega$	$V_{GS}=10V, I_D=3.2435A, T_j=25^\circ\text{C}$ $V_{GS}=10V, I_D=3.2435A, T_j=150^\circ\text{C}$
Gate resistance	$R_G$	-	17	-	$\Omega$	$f=1\text{MHz}$ , open drain

**Table 5 Dynamic characteristics**

Parameter	Symbol	Values			Unit	Note / Test Condition
		Min.	Typ.	Max.		
Input capacitance	$C_{iss}$	-	710	-	pF	$V_{GS}=0V, V_{DS}=100V, f=1\text{MHz}$
Output capacitance	$C_{oss}$	-	41	-	pF	$V_{GS}=0V, V_{DS}=100V, f=1\text{MHz}$
Effective output capacitance, energy related <sup>1)</sup>	$C_{o(er)}$	-	32	-	pF	$V_{GS}=0V, V_{DS}=0\dots480V$
Effective output capacitance, time related <sup>2)</sup>	$C_{o(tr)}$	-	140	-	pF	$I_D=\text{constant}, V_{GS}=0V, V_{DS}=0\dots480V$
Turn-on delay time	$t_{d(on)}$	-	12	-	ns	$V_{DD}=400V, V_{GS}=13V, I_D=4.86525A, R_G=4.9\Omega$ ; see table 9
Rise time	$t_r$	-	12	-	ns	$V_{DD}=400V, V_{GS}=13V, I_D=4.86525A, R_G=4.9\Omega$ ; see table 9
Turn-off delay time	$t_{d(off)}$	-	110	-	ns	$V_{DD}=400V, V_{GS}=13V, I_D=4.86525A, R_G=4.9\Omega$ ; see table 9
Fall time	$t_f$	-	11	-	ns	$V_{DD}=400V, V_{GS}=13V, I_D=4.86525A, R_G=4.9\Omega$ ; see table 9

**Table 6 Gate charge characteristics**

Parameter	Symbol	Values			Unit	Note / Test Condition
		Min.	Typ.	Max.		
Gate to source charge	$Q_{gs}$	-	4	-	nC	$V_{DD}=480V, I_D=4.86525A, V_{GS}=0$ to 10V
Gate to drain charge	$Q_{gd}$	-	20	-	nC	$V_{DD}=480V, I_D=4.86525A, V_{GS}=0$ to 10V
Gate charge total	$Q_g$	-	39	-	nC	$V_{DD}=480V, I_D=4.86525A, V_{GS}=0$ to 10V
Gate plateau voltage	$V_{plateau}$	-	5.5	-	V	$V_{DD}=480V, I_D=4.86525A, V_{GS}=0$ to 10V

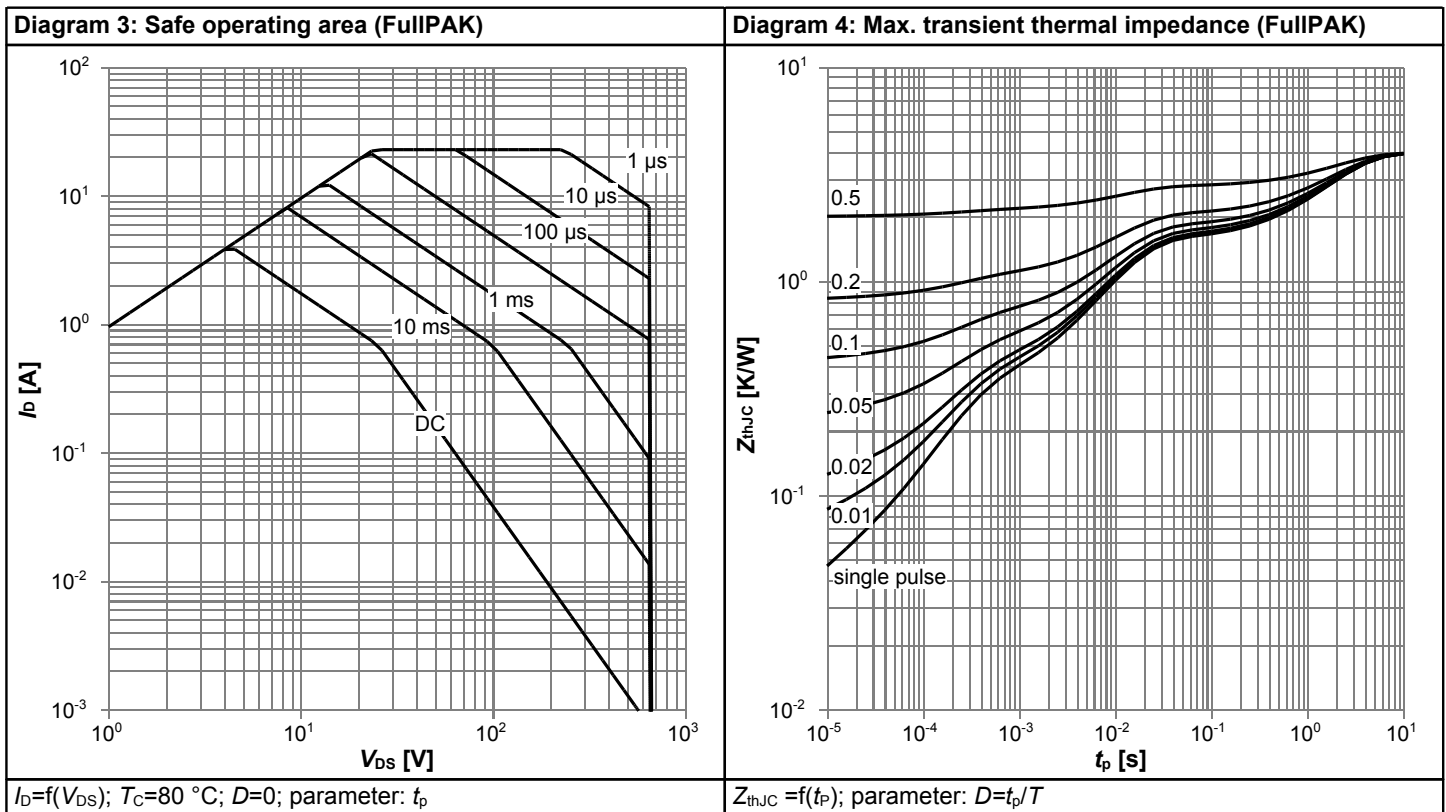
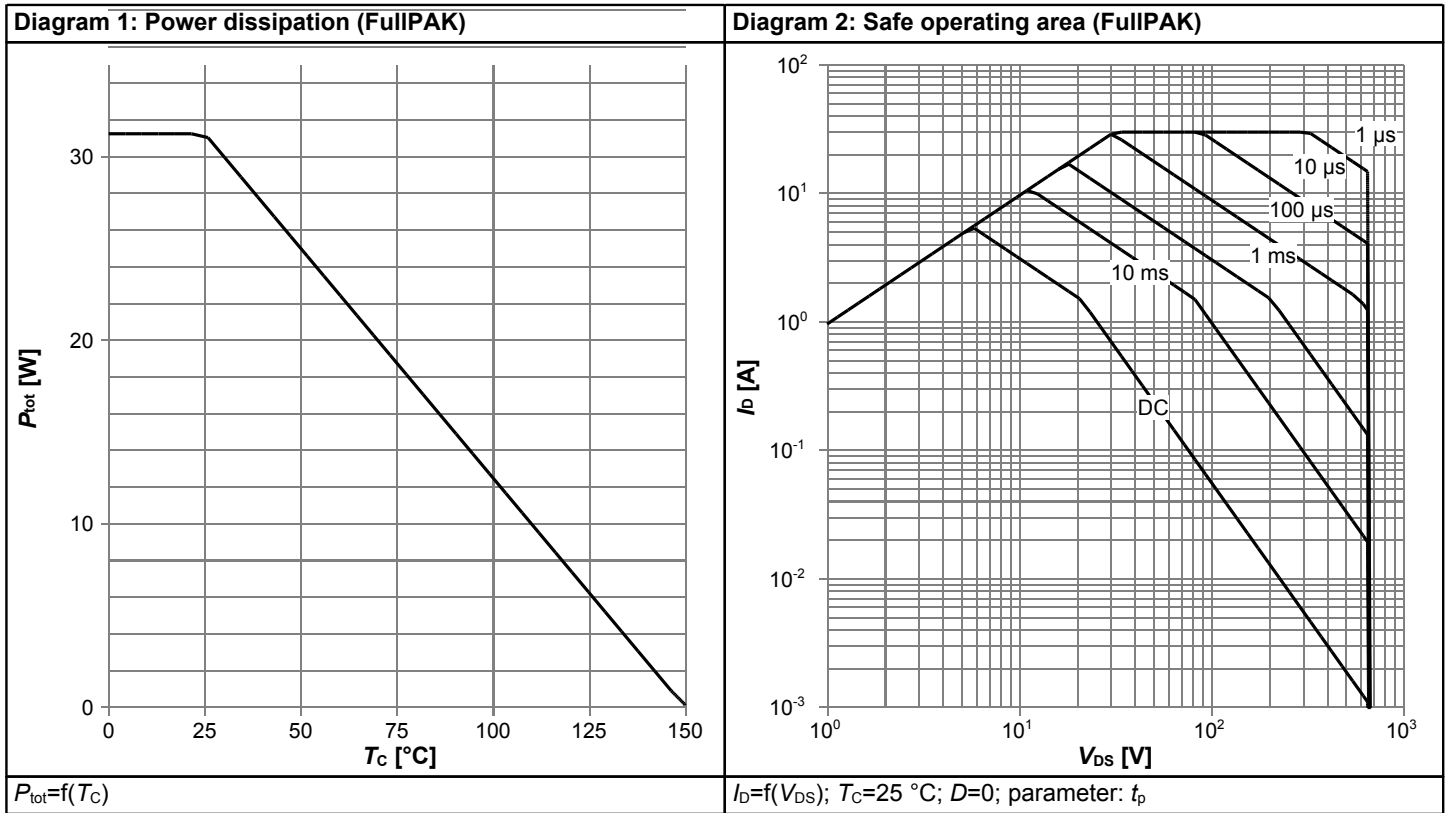
<sup>1)</sup>  $C_{o(er)}$  is a fixed capacitance that gives the same stored energy as  $C_{oss}$  while  $V_{DS}$  is rising from 0 to 480V

<sup>2)</sup>  $C_{o(tr)}$  is a fixed capacitance that gives the same charging time as  $C_{oss}$  while  $V_{DS}$  is rising from 0 to 480V

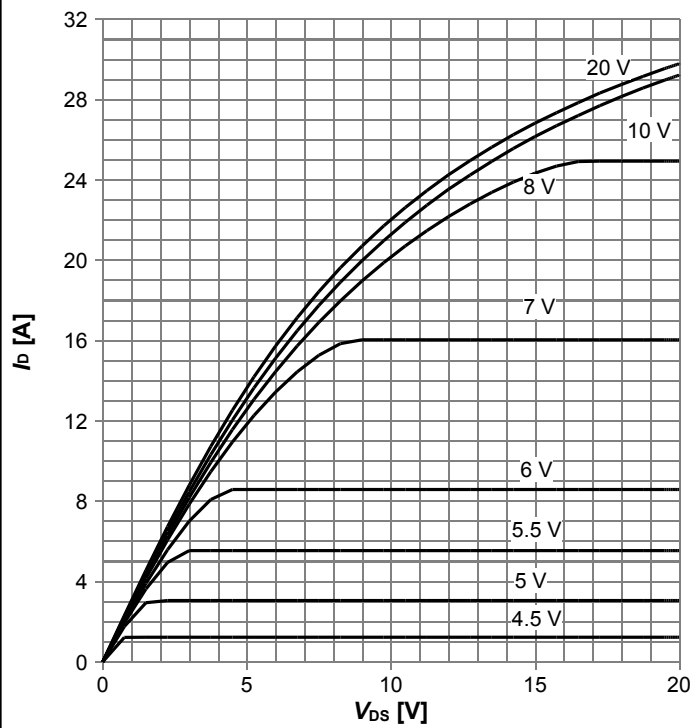
**Table 7 Reverse diode characteristics**

Parameter	Symbol	Values			Unit	Note / Test Condition
		Min.	Typ.	Max.		
Diode forward voltage	$V_{SD}$	-	0.9	-	V	$V_{GS}=0V, I_F=4.9A, T_j=25^\circ C$
Reverse recovery time	$t_{rr}$	-	280	-	ns	$V_R=400V, I_F=4.9A, di_F/dt=100A/\mu s$ ; see table 19
Reverse recovery charge	$Q_{rr}$	-	2.8	-	$\mu C$	$V_R=400V, I_F=4.9A, di_F/dt=100A/\mu s$ ; see table 19
Peak reverse recovery current	$I_{rrm}$	-	17	-	A	$V_R=400V, I_F=4.9A, di_F/dt=100A/\mu s$ ; see table 19

### 4 Electrical characteristics diagrams

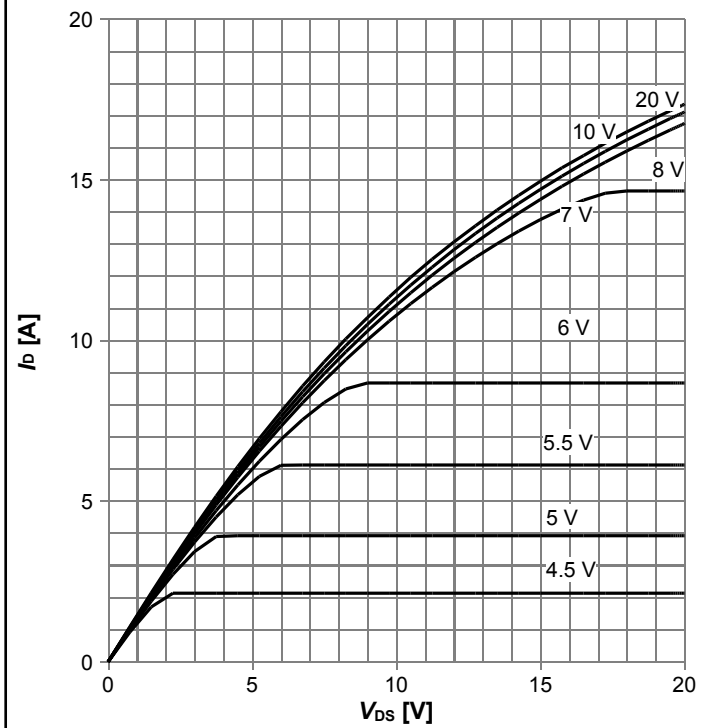


**Diagram 5: Typ. output characteristics**



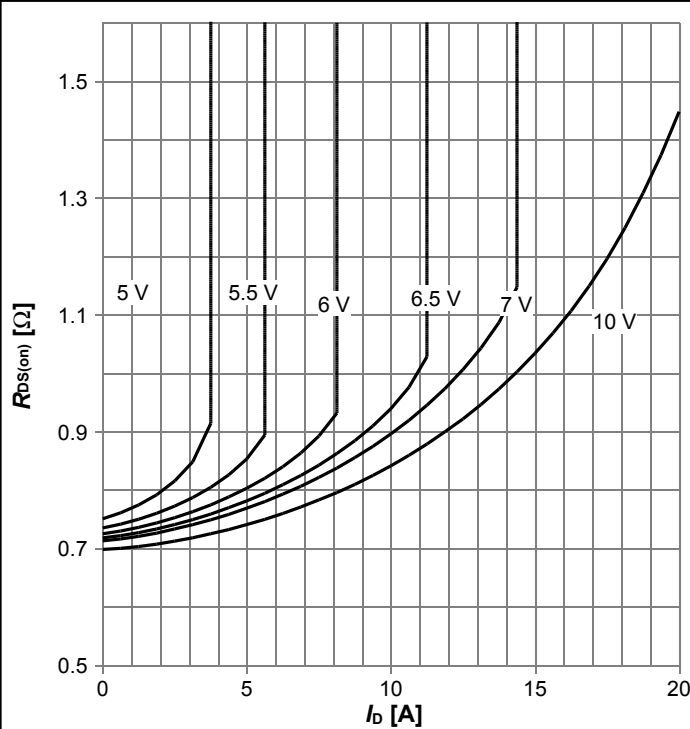
$I_D=f(V_{DS}); T_j=25\text{ °C}; \text{parameter: } V_{GS}$

**Diagram 6: Typ. output characteristics**



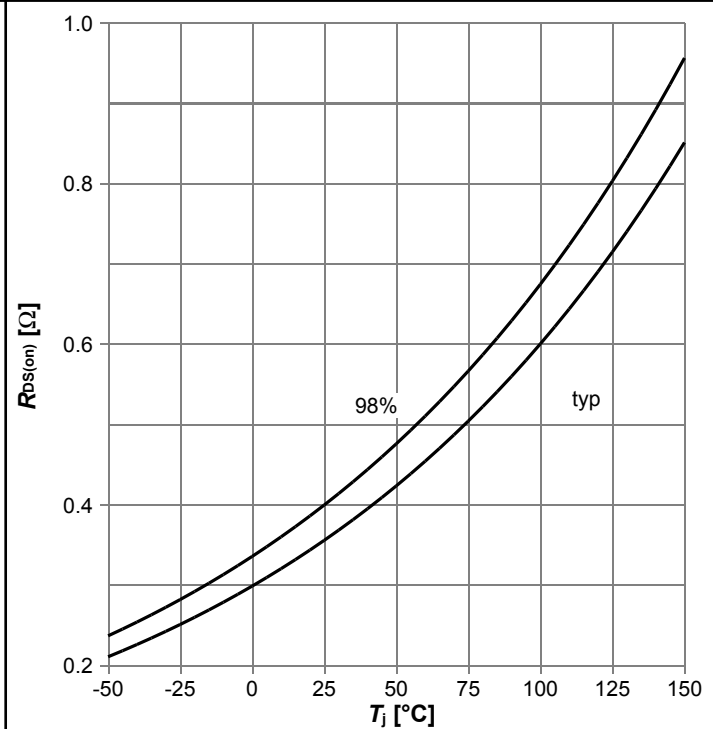
$I_D=f(V_{DS}); T_j=125\text{ °C}; \text{parameter: } V_{GS}$

**Diagram 7: Typ. drain-source on-state resistance**



$R_{DS(on)}=f(I_D); T_j=125\text{ °C}; \text{parameter: } V_{GS}$

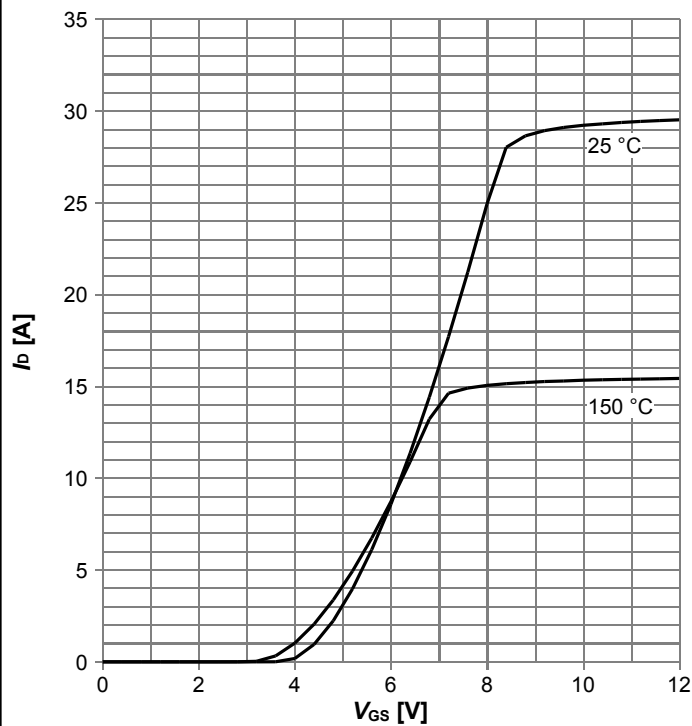
**Diagram 8: Drain-source on-state resistance**



$R_{DS(on)}=f(T_j); I_D=3.2\text{A}; V_{GS}=10\text{ V}$

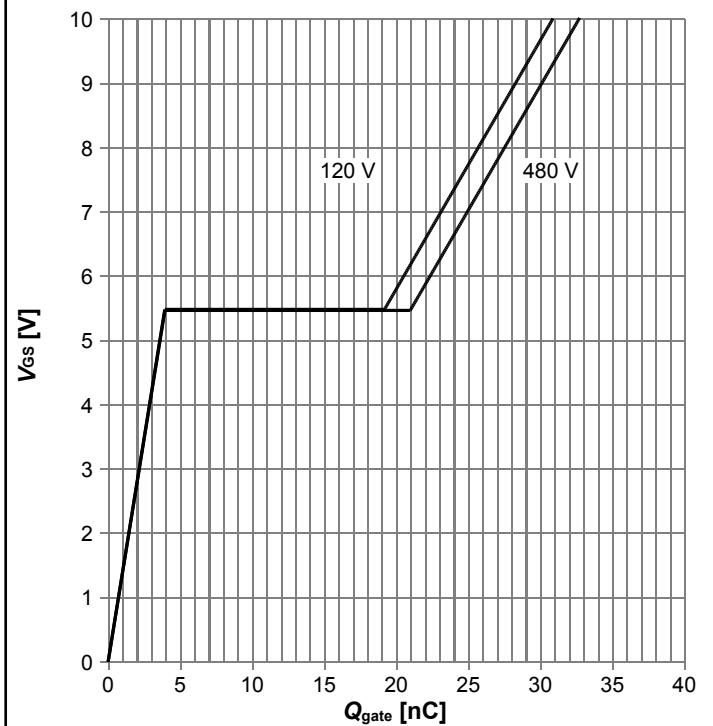


Diagram 9: Typ. transfer characteristics



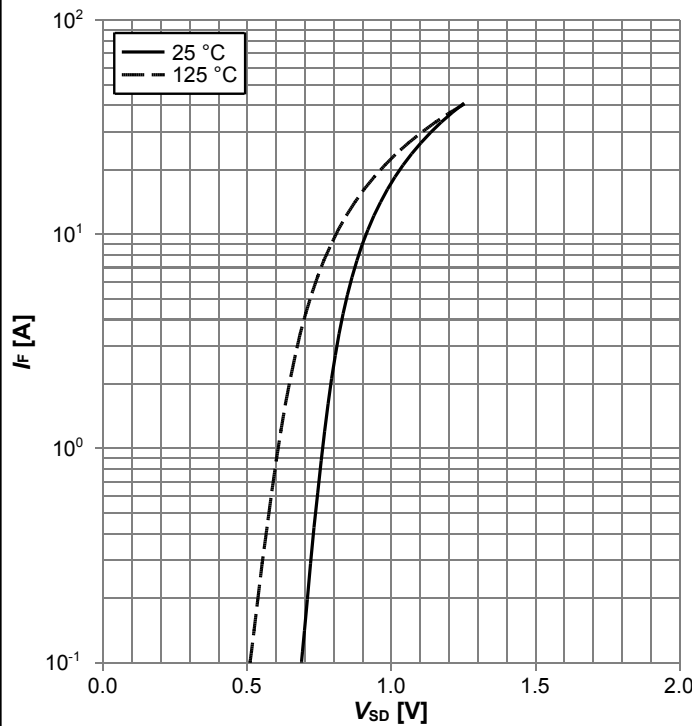
$I_D = f(V_{GS})$ ;  $V_{DS} = 20V$ ; parameter:  $T_j$

Diagram 10: Typ. gate charge



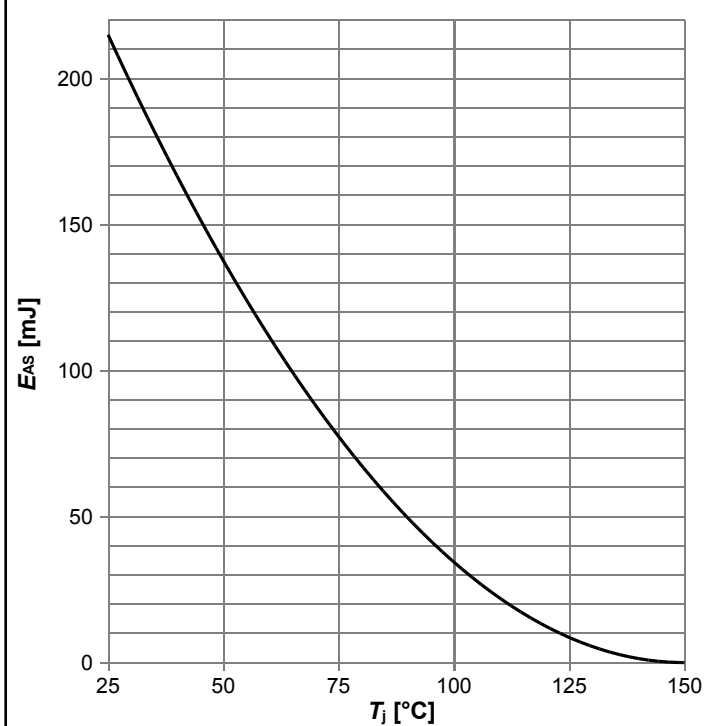
$V_{GS} = f(Q_{gate})$ ;  $I_D = 4.9 A$  pulsed; parameter:  $V_{DD}$

Diagram 11: Forward characteristics of reverse diode



$I_F = f(V_{SD})$ ; parameter:  $T_j$

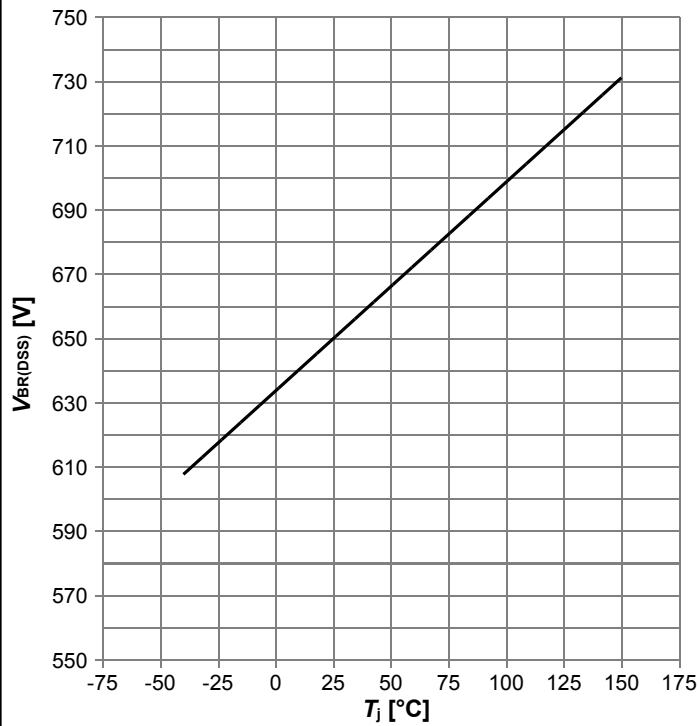
Diagram 12: Avalanche energy



$E_{AS} = f(T_j)$ ;  $I_D = 1.8 A$ ;  $V_{DD} = 50 V$

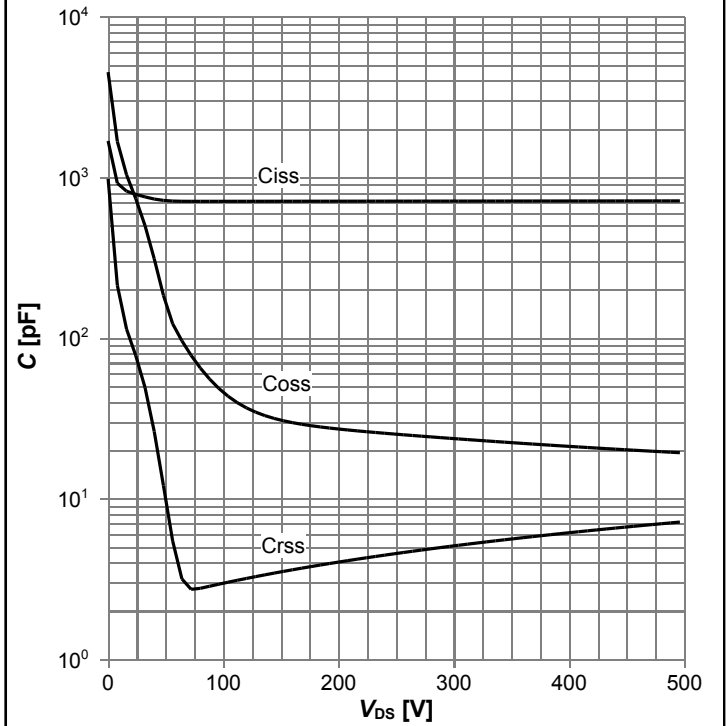
**650V CoolMOS™ CE Power Transistor**  
**IPA65R400CE**

**Diagram 13: Drain-source breakdown voltage**



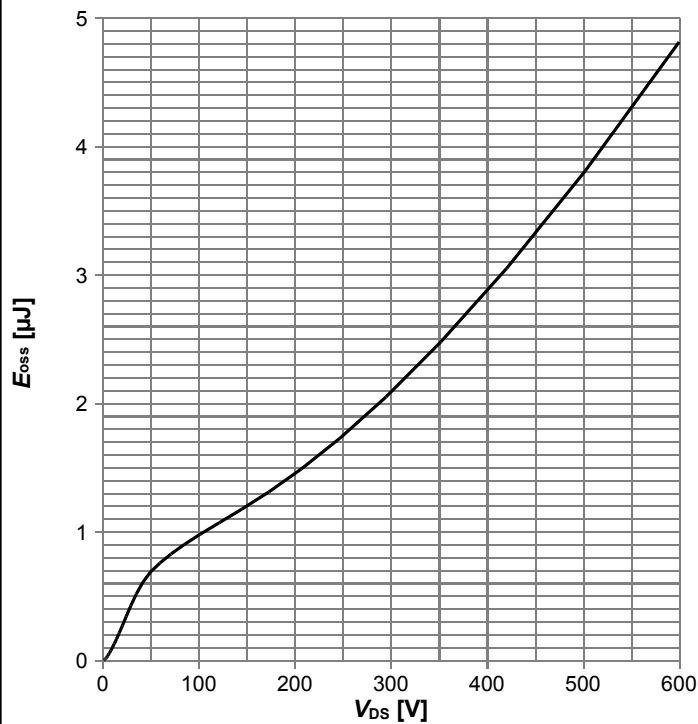
$V_{BR(DSS)}=f(T_j); I_D=1.0 \text{ mA}$

**Diagram 14: Typ. capacitances**



$C=f(V_{DS}); V_{GS}=0 \text{ V}; f=1 \text{ MHz}$

**Diagram 15: Typ. Coss stored energy**



$E_{oss}=f(V_{DS})$

## 5 Test Circuits

**Table 8 Diode characteristics**



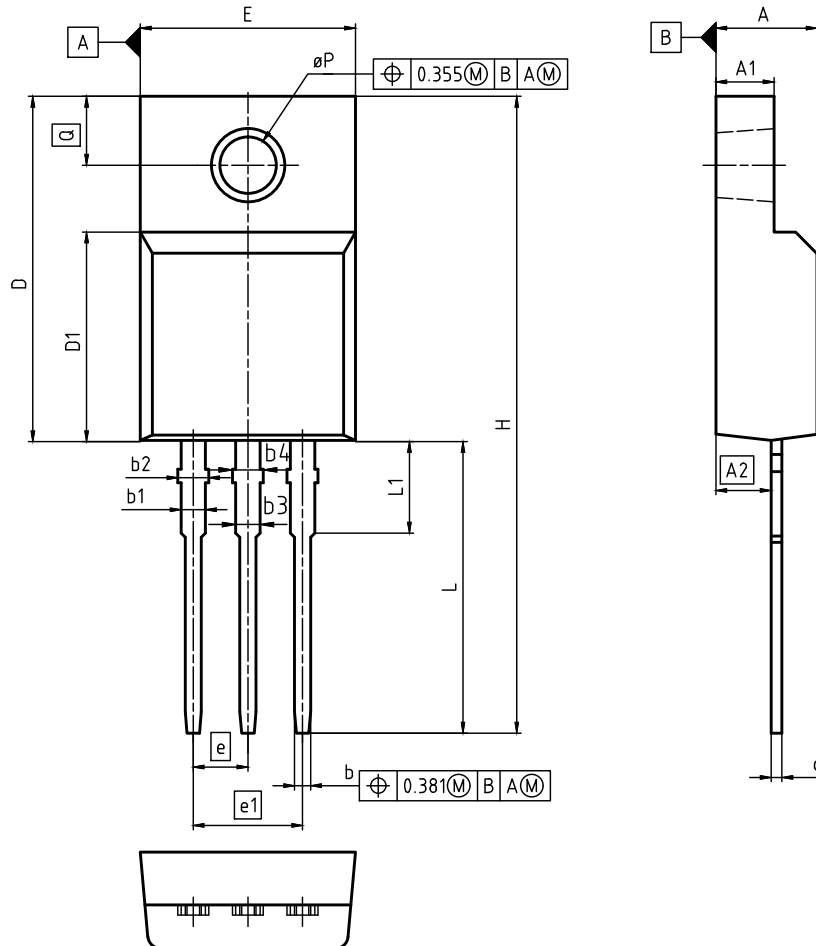
**Table 9 Switching times**



**Table 10 Unclamped inductive load**



## 6 Package Outlines



DIM	MILLIMETERS		INCHES	
	MIN	MAX	MIN	MAX
A	4.50	4.90	0.177	0.193
A1	2.34	2.85	0.092	0.112
A2	2.42	2.86	0.095	0.113
b	0.65	0.90	0.026	0.035
b1	0.95	1.38	0.037	0.054
b2	0.95	1.51	0.037	0.059
b3	0.65	1.38	0.026	0.054
b4	0.65	1.51	0.026	0.059
c	0.40	0.63	0.016	0.025
D	15.67	16.15	0.617	0.636
D1	8.97	9.83	0.353	0.387
E	10.00	10.65	0.394	0.419
e	2.54 (BSC)		0.100 (BSC)	
e1	5.08		0.200	
N	3		3	
H	28.70	29.75	1.130	1.171
L	12.78	13.75	0.503	0.541
L1	2.83	3.45	0.111	0.136
$\varnothing P$	2.95	3.38	0.116	0.133
Q	3.15	3.50	0.124	0.138

Dimensions do not include mold flash, protrusions or gate burrs

DOCUMENT NO.  
Z8B00003319

SCALE

EUROPEAN PROJECTION

ISSUE DATE  
05-05-2014

REVISION  
04

Figure 1 Outline PG-TO 220 FullPAK, dimensions in mm/inches

## 7 Appendix A

Table 11 Related Links

- IFX CoolMOS™ CE Webpage: [www.infineon.com](http://www.infineon.com)
- IFX CoolMOS™ CE application note: [www.infineon.com](http://www.infineon.com)
- IFX CoolMOS™ CE simulation model: [www.infineon.com](http://www.infineon.com)
- IFX Design tools: [www.infineon.com](http://www.infineon.com)

## Revision History

IPA65R400CE

Revision: 2017-04-19, Rev. 2.1

### Previous Revision

Revision	Date	Subjects (major changes since last revision)
2.0	2016-02-24	Release of final version
2.1	2017-04-19	Modified Rg value in Table 6 and timing value in Table 7

Trademarks of Infineon Technologies AG

AURIX™, C166™, CanPAK™, CIPOS™, CoolGaN™, CoolMOS™, CoolSET™, CoolSiC™, CORECONTROL™, CROSSAVE™, DAVE™, DI-POL™, DrBlade™, EasyPIM™, EconoBRIDGE™, EconoDUAL™, EconoPACK™, EconoPIM™, EiceDRIVER™, eupec™, FCOS™, HITFET™, HybridPACK™, Infineon™, ISOFACE™, IsoPACK™, i-Wafer™, MIPAQ™, ModSTACK™, my-d™, NovalithIC™, OmniTune™, OPTIGAT™, OptiMOS™, ORIGAT™, POWERCODE™, PRIMARION™, PrimePACK™, PrimeSTACK™, PROFET™, PRO-SIL™, RASIC™, REAL3™, ReverSave™, SatRIC™, SIEGET™, SIPMOS™, SmartLEWIS™, SOLID FLASH™, SPOC™, TEMPFET™, thinQ!™, TRENCHSTOP™, TriCore™.

Trademarks updated August 2015

Other Trademarks

All referenced product or service names and trademarks are the property of their respective owners.

### We Listen to Your Comments

Any information within this document that you feel is wrong, unclear or missing at all? Your feedback will help us to continuously improve the quality of this document. Please send your proposal (including a reference to this document) to: [erratum@infineon.com](mailto:erratum@infineon.com)

Published by  
Infineon Technologies AG  
81726 München, Germany  
© 2017 Infineon Technologies AG  
All Rights Reserved.

### Legal Disclaimer

The information given in this document shall in no event be regarded as a guarantee of conditions or characteristics ("Beschaffenheitsgarantie").

With respect to any examples, hints or any typical values stated herein and/or any information regarding the application of the product, Infineon Technologies hereby disclaims any and all warranties and liabilities of any kind, including without limitation warranties of non-infringement of intellectual property rights of any third party.

In addition, any information given in this document is subject to customer's compliance with its obligations stated in this document and any applicable legal requirements, norms and standards concerning customer's products and any use of the product of Infineon Technologies in customer's applications.

The data contained in this document is exclusively intended for technically trained staff. It is the responsibility of customer's technical departments to evaluate the suitability of the product for the intended application and the completeness of the product information given in this document with respect to such application.

### Information

For further information on technology, delivery terms and conditions and prices please contact your nearest Infineon Technologies Office ([www.infineon.com](http://www.infineon.com)).

### Warnings

Due to technical requirements, components may contain dangerous substances. For information on the types in question, please contact the nearest Infineon Technologies Office.

The Infineon Technologies component described in this Data Sheet may be used in life-support devices or systems and/or automotive, aviation and aerospace applications or systems only with the express written approval of Infineon Technologies, if a failure of such components can reasonably be expected to cause the failure of that life-support, automotive, aviation and aerospace device or system or to affect the safety or effectiveness of that device or system. Life support devices or systems are intended to be implanted in the human body or to support and/or maintain and sustain and/or protect human life. If they fail, it is reasonable to assume that the health of the user or other persons may be endangered.

单击下面可查看定价，库存，交付和生命周期等信息

[>>Infineon Technologies\(英飞凌\)](#)