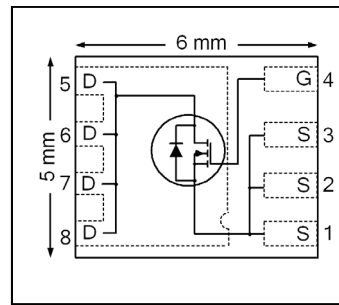


HEXFET® Power MOSFET

<b>V<sub>DSS</sub></b>	<b>100</b>	<b>V</b>
<b>R<sub>DS(on)</sub> max</b> (@ V <sub>GS</sub> = 10V)	<b>5.2</b>	<b>mΩ</b>
<b>Q<sub>g</sub> (typical)</b>	<b>36</b>	<b>nC</b>
<b>R<sub>g</sub> (typical)</b>	<b>1.2</b>	<b>Ω</b>
<b>I<sub>D</sub></b> (@T <sub>C(Bottom)</sub> = 25°C)	<b>123</b>	<b>A</b>



**Applications**

- Primary Switch for High Frequency 48V/60V Telecom DC-DC Power Supplies
- Secondary Side Synchronous Rectifier
- Hot Swap and Active O-Ring

**Features**

Low R <sub>DS(ON)</sub> (< 5.2mΩ)
Low Thermal Resistance to PCB (<0.8°C/W)
100% R <sub>g</sub> Tested
Low Profile (<1.05 mm)
Industry-Standard Pinout
Compatible with Existing Surface Mount Techniques
RoHS Compliant, Halogen-Free
MSL1

results in  
⇒

**Benefits**

Lower Conduction Losses
Increased Power Density
Increased Reliability
Increased Power Density
Multi-Vendor Compatibility
Easier Manufacturing
Environmentally Friendlier
Increased Reliability

Base part number	Package Type	Standard Pack		Orderable Part Number
		Form	Quantity	
IRFH7185PbF	PQFN 5mm x 6 mm	Tape and Reel	4000	IRFH7185TRPbF

**Absolute Maximum Ratings**

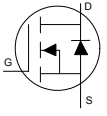
	Parameter	Max.	Units
V <sub>GS</sub>	Gate-to-Source Voltage	± 20	V
I <sub>D</sub> @ T <sub>A</sub> = 25°C	Continuous Drain Current, V <sub>GS</sub> @ 10V	19	A
I <sub>D</sub> @ T <sub>C(Bottom)</sub> = 25°C	Continuous Drain Current, V <sub>GS</sub> @ 10V	123	
I <sub>D</sub> @ T <sub>C(Bottom)</sub> = 100°C	Continuous Drain Current, V <sub>GS</sub> @ 10V	78	
I <sub>DM</sub>	Pulsed Drain Current ①	260	
P <sub>D</sub> @ T <sub>A</sub> = 25°C	Power Dissipation	3.6	W
P <sub>D</sub> @ T <sub>C(Bottom)</sub> = 25°C	Power Dissipation	160	
	Linear Derating Factor	0.03	W/°C
T <sub>J</sub>	Operating Junction and	-55 to + 150	°C
T <sub>STG</sub>	Storage Temperature Range		

Notes ① through ⑤ are on page 9

**Static @  $T_J = 25^\circ\text{C}$  (unless otherwise specified)**

	Parameter	Min.	Typ.	Max.	Units	Conditions
$BV_{DSS}$	Drain-to-Source Breakdown Voltage	100	—	—	V	$V_{GS} = 0V, I_D = 250\mu A$
$\Delta BV_{DSS}/\Delta T_J$	Breakdown Voltage Temp. Coefficient	—	54	—	mV/°C	Reference to $25^\circ\text{C}, I_D = 1\text{mA}$
$R_{DS(on)}$	Static Drain-to-Source On-Resistance	—	4.2	5.2	m $\Omega$	$V_{GS} = 10V, I_D = 50A$ ③
$V_{GS(th)}$	Gate Threshold Voltage	2.0	—	3.6	V	$V_{DS} = V_{GS}, I_D = 150\mu A$
$\Delta V_{GS(th)}$	Gate Threshold Voltage Coefficient	—	-5.3	—	mV/°C	
$I_{DSS}$	Drain-to-Source Leakage Current	—	—	1.0	$\mu A$	$V_{DS} = 80V, V_{GS} = 0V$
$I_{GSS}$	Gate-to-Source Forward Leakage	—	—	100	nA	$V_{GS} = 20V$
	Gate-to-Source Reverse Leakage	—	—	-100		$V_{GS} = -20V$
$g_{fs}$	Forward Transconductance	117	—	—	S	$V_{DS} = 25V, I_D = 50A$
$Q_g$	Total Gate Charge	—	36	54	nC	$V_{DS} = 50V$ $V_{GS} = 10V$ $I_D = 50A$
$Q_{gs1}$	Pre-Vth Gate-to-Source Charge	—	7.3	—		
$Q_{gs2}$	Post-Vth Gate-to-Source Charge	—	2.7	—		
$Q_{gd}$	Gate-to-Drain Charge	—	11	—		
$Q_{godr}$	Gate Charge Overdrive	—	15	—		
$Q_{sw}$	Switch Charge ( $Q_{gs2} + Q_{gd}$ )	—	13.7	—		
$Q_{oss}$	Output Charge	—	120	—	nC	$V_{DS} = 50V, V_{GS} = 0V$
$R_G$	Gate Resistance	—	1.2	—	$\Omega$	
$t_{d(on)}$	Turn-On Delay Time	—	6.5	—	ns	$V_{DD} = 50V, V_{GS} = 10V$ $I_D = 50A$ $R_G = 1.0\Omega$
$t_r$	Rise Time	—	9.9	—		
$t_{d(off)}$	Turn-Off Delay Time	—	14	—		
$t_f$	Fall Time	—	3.9	—		
$C_{iss}$	Input Capacitance	—	2320	—	pF	$V_{GS} = 0V$ $V_{DS} = 50V$ $f = 1.0\text{MHz}$
$C_{oss}$	Output Capacitance	—	1070	—		
$C_{rss}$	Reverse Transfer Capacitance	—	19	—		

**Diode Characteristics**

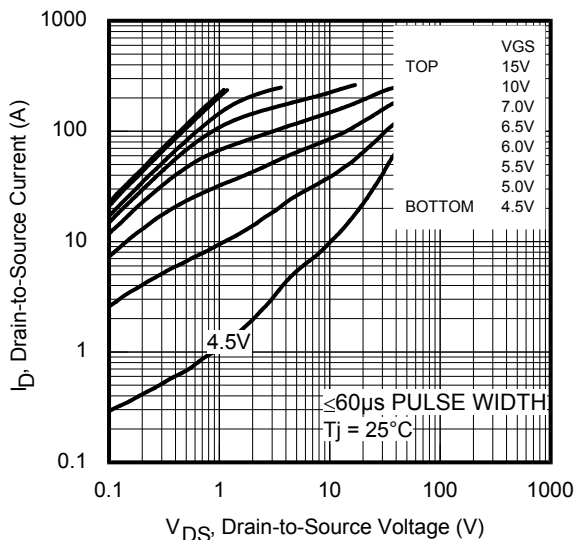
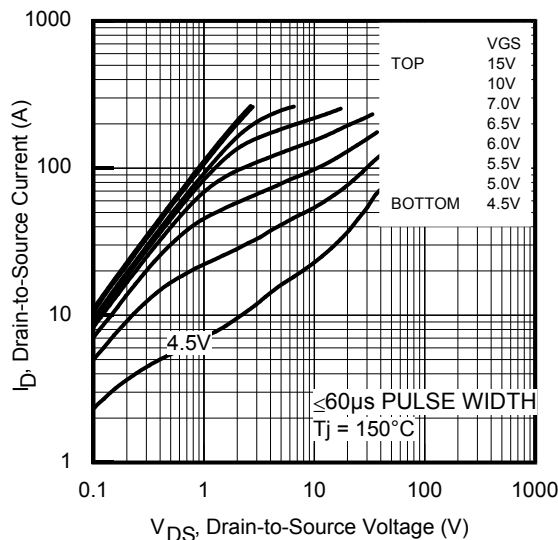
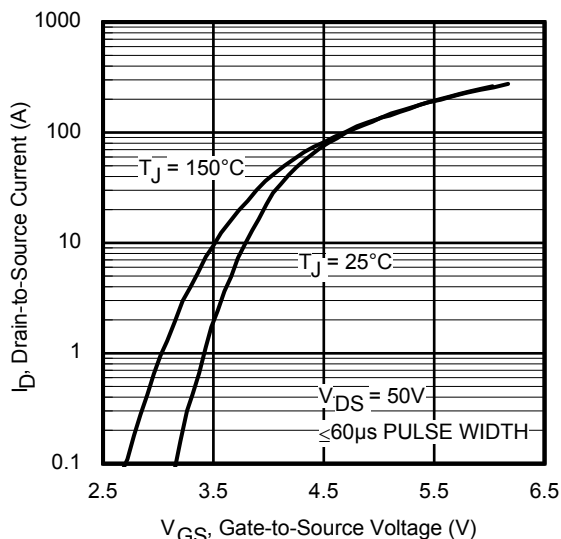
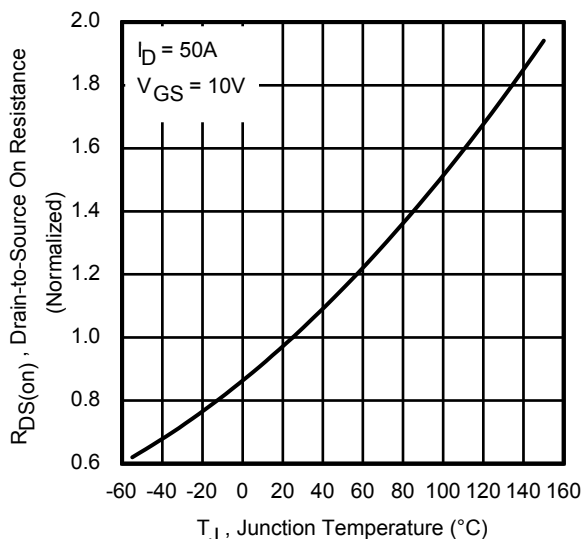
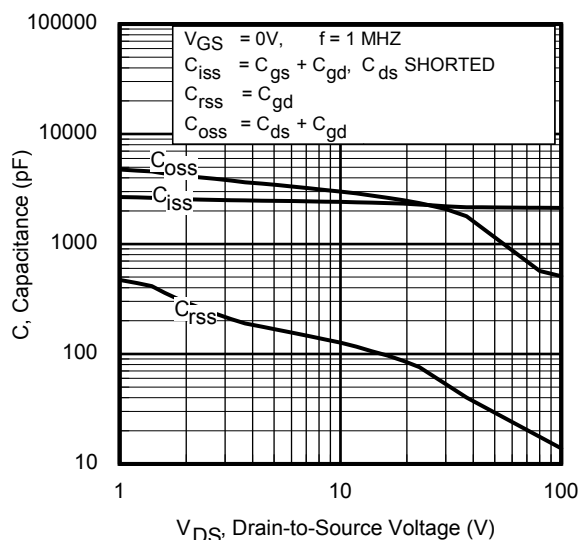
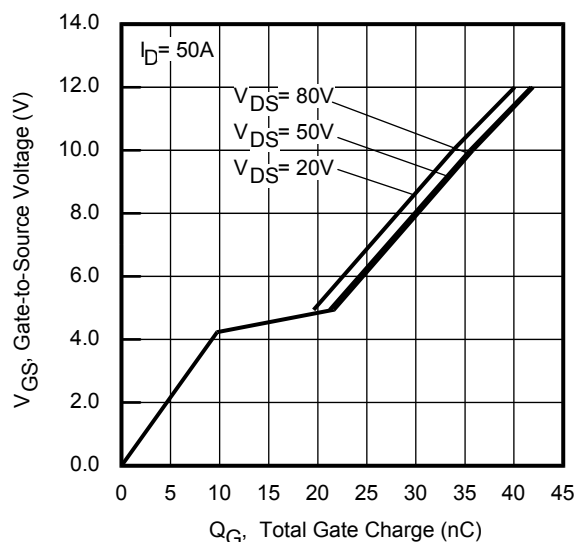
	Parameter	Min.	Typ.	Max.	Units	Conditions
$I_S$	Continuous Source Current (Body Diode)	—	—	123	A	MOSFET symbol showing the integral reverse p-n junction diode. 
$I_{SM}$	Pulsed Source Current (Body Diode) ①	—	—	260		
$V_{SD}$	Diode Forward Voltage	—	0.8	1.3	V	$T_J = 25^\circ\text{C}, I_S = 50A, V_{GS} = 0V$ ③
$t_{rr}$	Reverse Recovery Time	—	63	95	ns	$T_J = 25^\circ\text{C}, I_F = 50A, V_{DD} = 50V$
$Q_{rr}$	Reverse Recovery Charge	—	110	165	nC	$di/dt = 100A/\mu s$ ③

**Avalanche Characteristics**

	Parameter	Typ.	Max.	Units
$E_{AS}$	Single Pulse Avalanche Energy ②	—	360	mJ
$I_{AR}$	Avalanche Current ①	—	50	A

**Thermal Resistance**

	Parameter	Typ.	Max.	Units
$R_{\theta JC}$ (Bottom)	Junction-to-Case ④	—	0.8	°C/W
$R_{\theta JC}$ (Top)	Junction-to-Case ④	—	19	
$R_{\theta JA}$	Junction-to-Ambient ⑤	—	35	
$R_{\theta JA}$ (<10s)	Junction-to-Ambient ⑤	—	23	


**Fig 1. Typical Output Characteristics**

**Fig 2. Typical Output Characteristics**

**Fig 3. Typical Transfer Characteristics**

**Fig 4. Normalized On-Resistance vs. Temperature**

**Fig 5. Typical Capacitance vs. Drain-to-Source Voltage**

**Fig 6. Typical Gate Charge vs. Gate-to-Source Voltage**

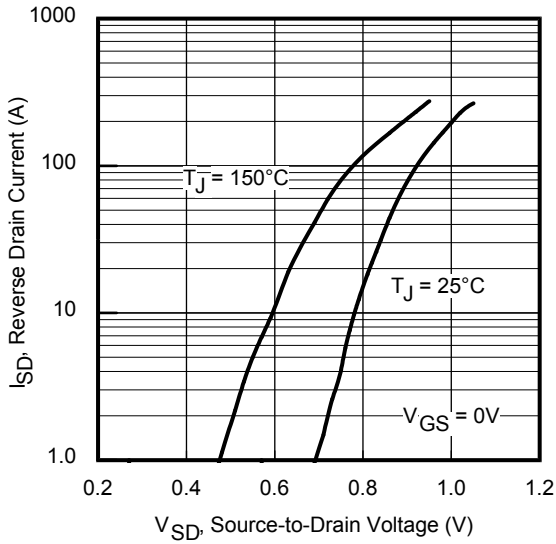


Fig 7. Typical Source-Drain Diode Forward Voltage

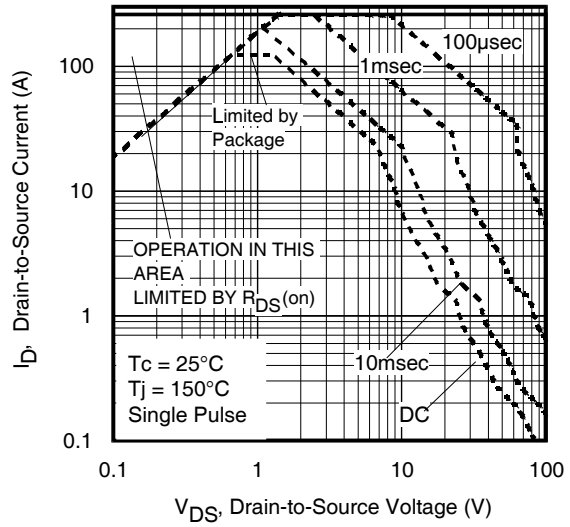


Fig 8. Maximum Safe Operating Area

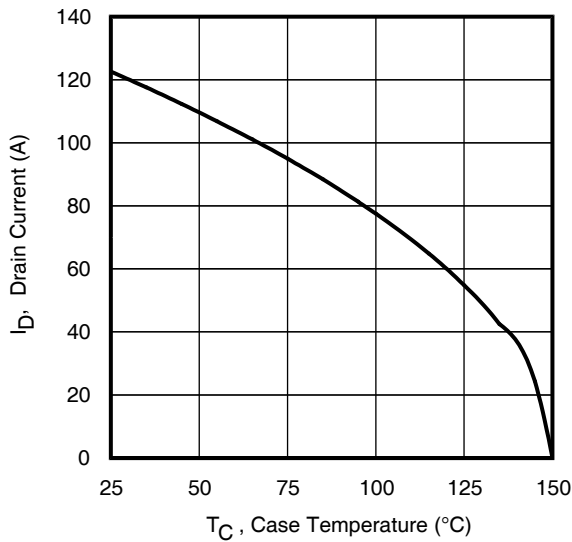


Fig 9. Maximum Drain Current vs. Case Temperature

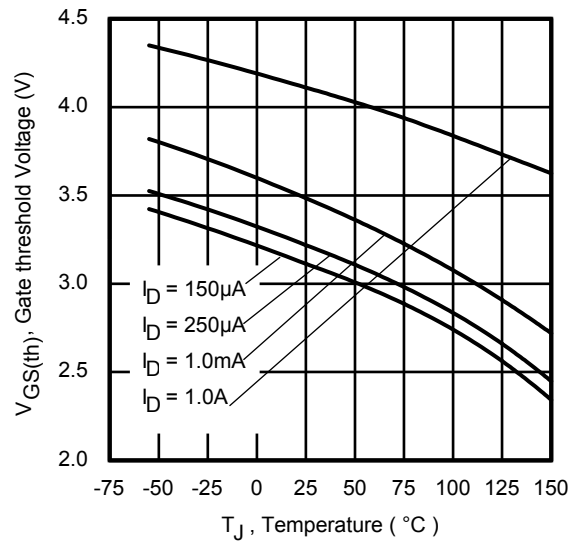


Fig 10. Threshold Voltage vs. Temperature

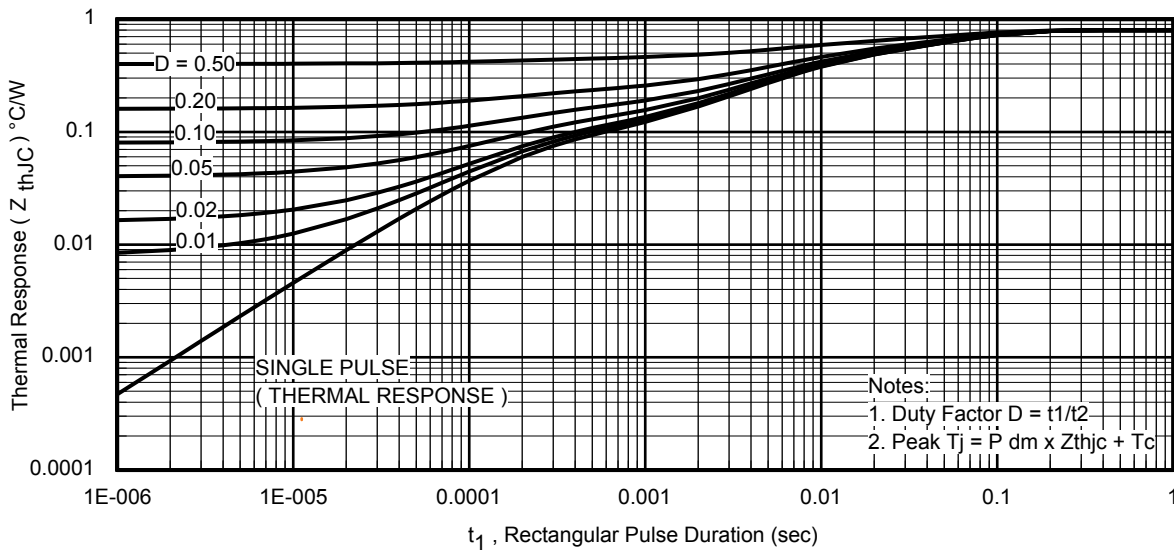


Fig 11. Maximum Effective Transient Thermal Impedance, Junction-to-Case

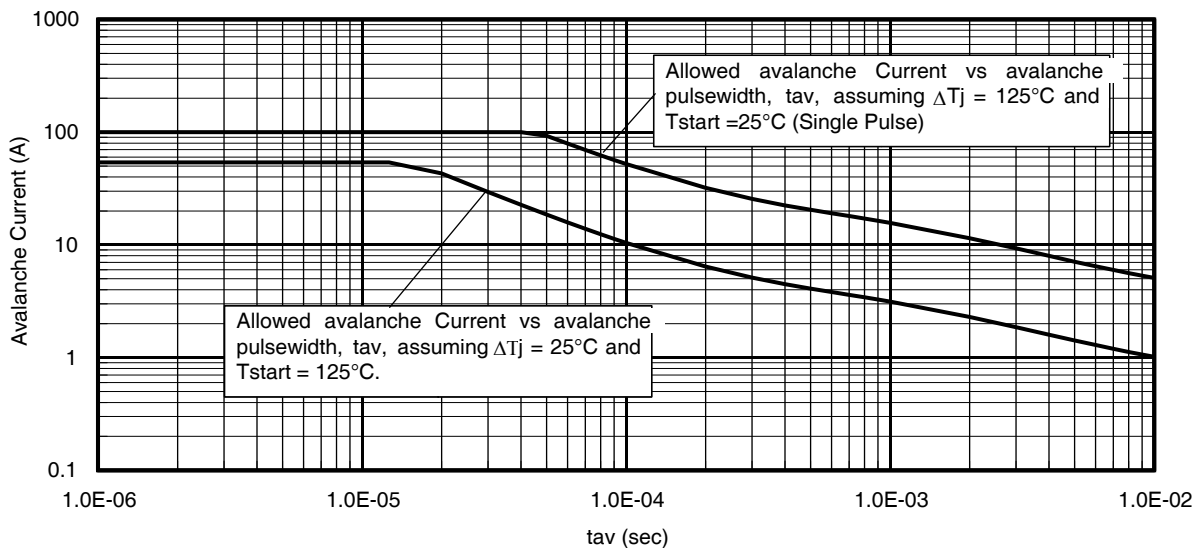


Fig 12. Typical Avalanche Current vs. Pulse Width

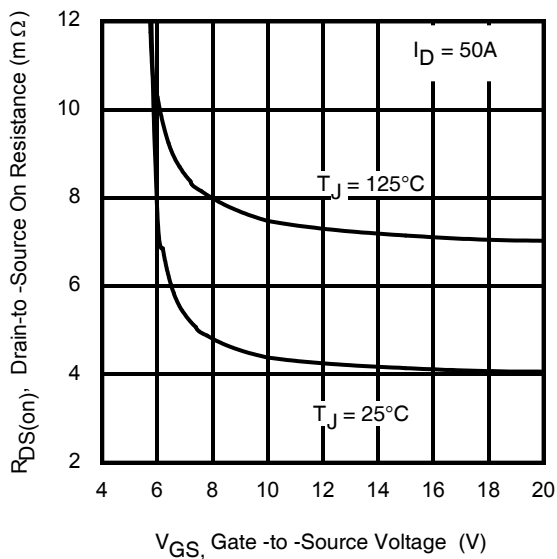


Fig 13. On-Resistance vs. Gate Voltage

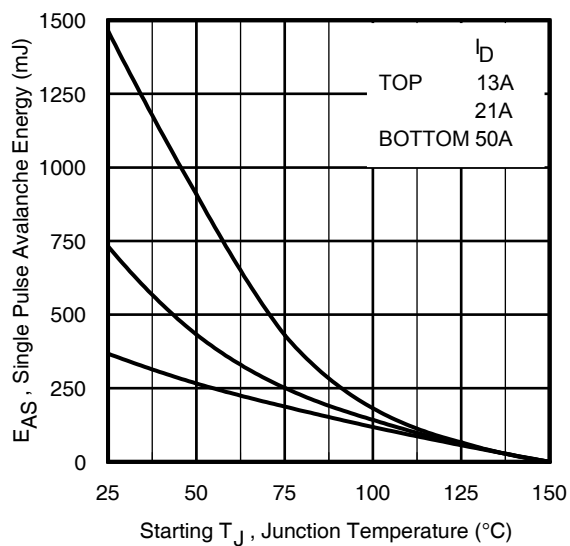
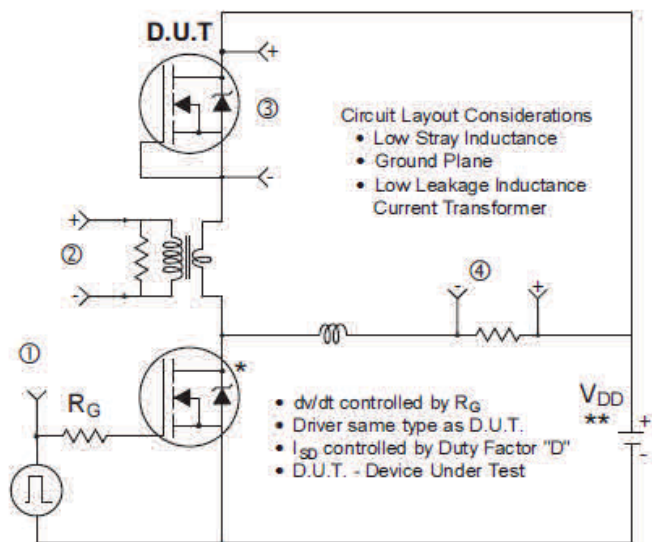
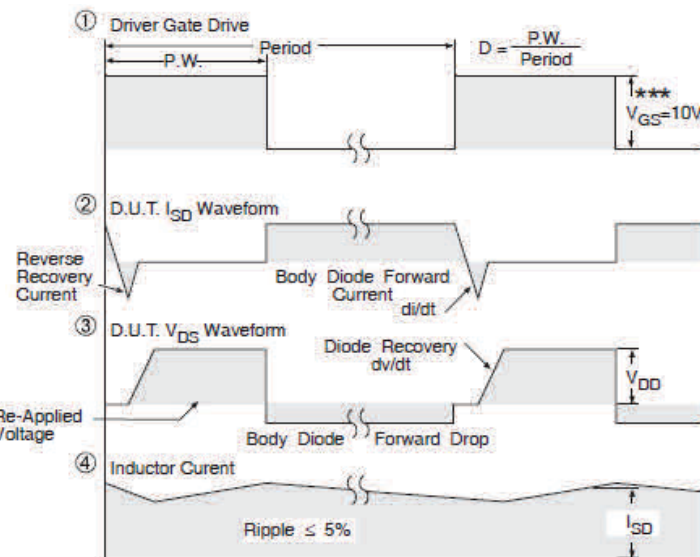


Fig 14. Maximum Avalanche Energy vs. Drain Current

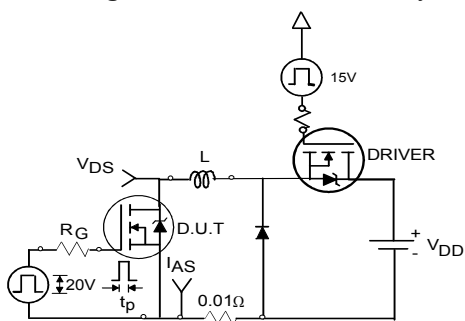


\* Use P-Channel Driver for P-Channel Measurements  
 \*\* Reverse Polarity for P-Channel

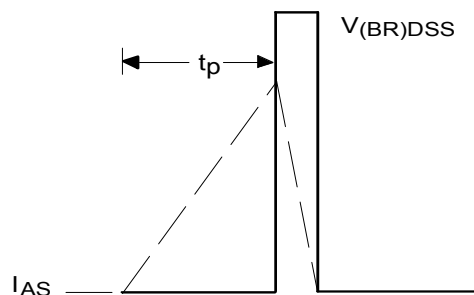


\*\*\*  $V_{GS} = 5V$  for Logic Level Devices

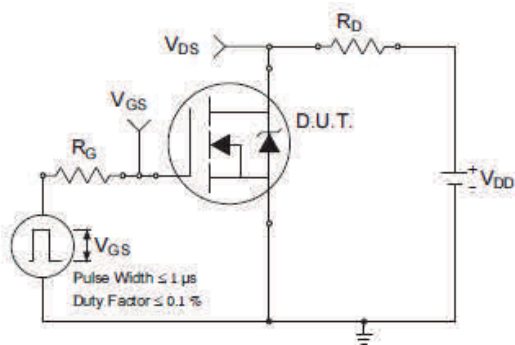
**Fig 15. Peak Diode Recovery dv/dt Test Circuit for N-Channel HEXFET® Power MOSFETs**



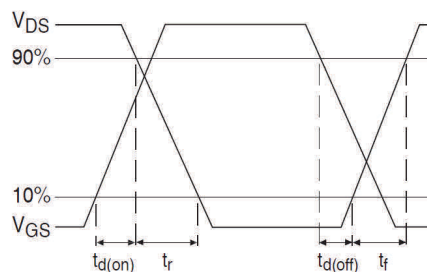
**Fig 16a. Unclamped Inductive Test Circuit**



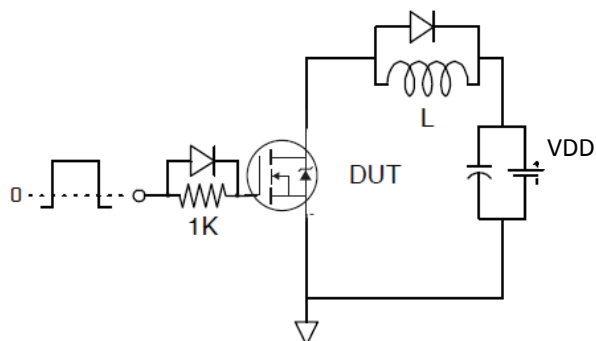
**Fig 16b. Unclamped Inductive Waveforms**



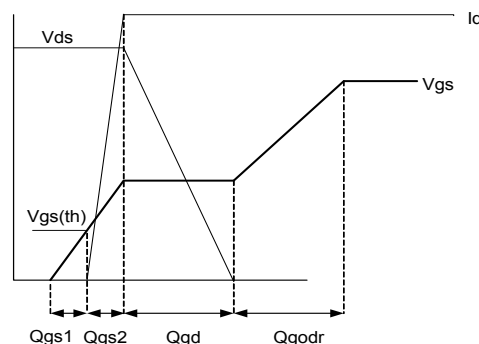
**Fig 17a. Switching Time Test Circuit**



**Fig 17b. Switching Time Waveforms**

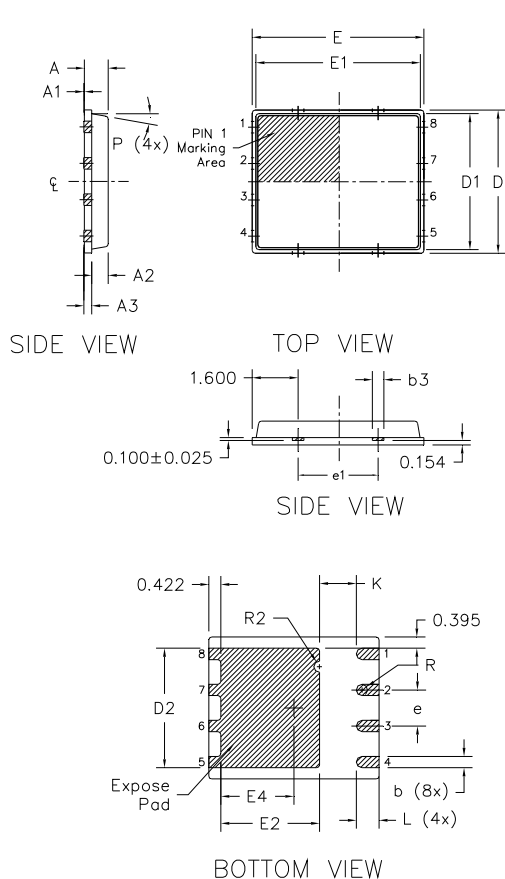


**Fig 18. Gate Charge Test Circuit**



**Fig 19. Gate Charge Waveform**

**PQFN 5x6 Outline "B" Package Details**

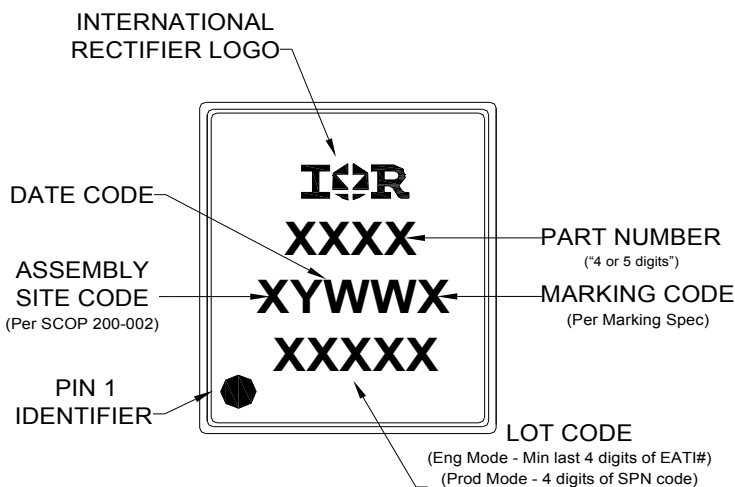


DIM SYMBOL	MILLIMETERS		INCH	
	MIN	MAX	MIN	MAX
A	0.800	0.900	0.0315	0.0543
A1	0.000	0.050	0.0000	0.0020
A3	0.200 REF		0.0079 REF	
b	0.350	0.470	0.0138	0.0185
b1	0.025	0.125	0.0010	0.0049
b2	0.210	0.410	0.0083	0.0161
b3	0.150	0.450	0.0059	0.0177
D	5.000 BSC		0.1969 BSC	
D1	4.750 BSC		0.1870 BSC	
D2	4.100	4.300	0.1614	0.1693
E	6.000 BSC		0.2362 BSC	
E1	5.750 BSC		0.2264 BSC	
E2	3.380	3.780	0.1331	0.1488
e	1.270 REF		0.0500 REF	
e1	2.800 REF		0.1102 REF	
K	1.200	1.420	0.0472	0.0559
L	0.710	0.900	0.0280	0.0354
P	0°	12°	0°	12°
R	0.200 REF		0.0079 REF	
R2	0.150	0.200	0.0059	0.0079

- Note:*
1. Dimensions and tolerancing confirm to ASME Y14.5M-1994
  2. Dimension L represents terminal full back from package edge up to 0.1mm is acceptable
  3. Coplanarity applies to the expose Heat Slug as well as the terminal
  4. Radius on terminal is Optional

For more information on board mounting, including footprint and stencil recommendation, please refer to application note AN-1136: <http://www.irf.com/technical-info/appnotes/an-1136.pdf>  
 For more information on package inspection techniques, please refer to application note AN-1154: <http://www.irf.com/technical-info/appnotes/an-1154.pdf>

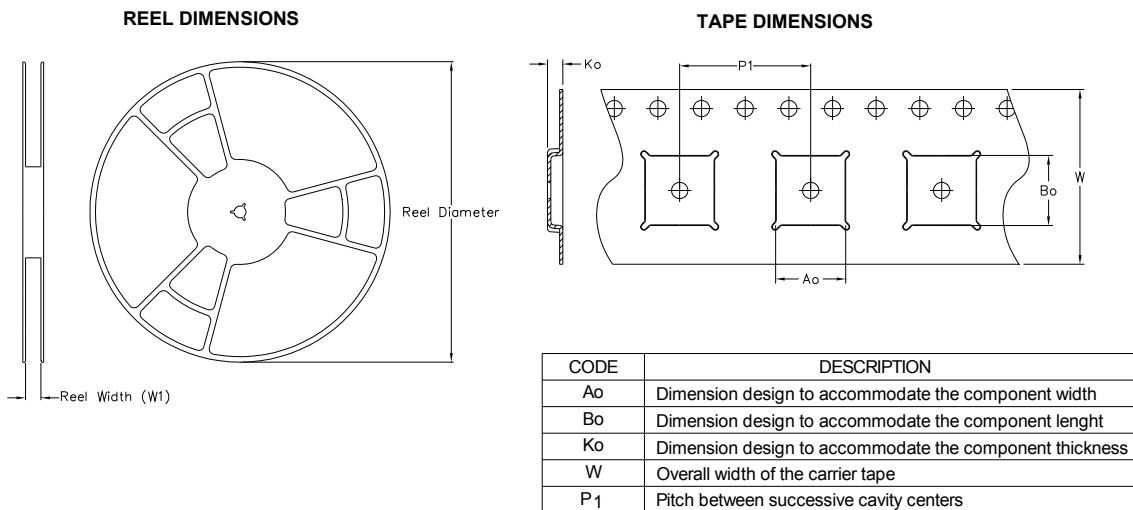
**PQFN 5x6 Part Marking**



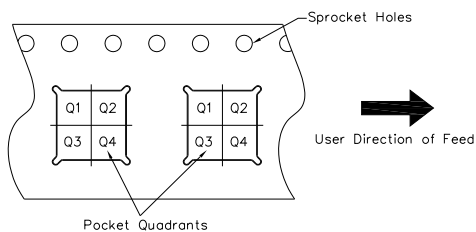
Note: For the most cur-

rent drawing

PQFN 5x6 Tape and Reel



**QUADRANT ASSIGNMENTS FOR PIN 1 ORIENTATION IN TAPE**



Note: All dimension are nominal

Package Type	Reel Diameter (Inch)	QTY	Reel Width W1 (mm)	Ao (mm)	Bo (mm)	Ko (mm)	P1 (mm)	W (mm)	Pin 1 Quadrant
5 X 6 PQFN	13	4000	12.4	6.300	5.300	1.20	8.00	12	Q1

Note: For the most current drawing please refer to IR website at <http://www.irf.com/package/>



**Qualification Information<sup>†</sup>**

<b>Qualification Level</b>	Industrial (per JEDEC JESD47F <sup>††</sup> guidelines)	
<b>Moisture Sensitivity Level</b>	PQFN 5mm x 6mm	MSL1 (per JEDEC J-STD-020D <sup>††</sup> )
<b>RoHS Compliant</b>	Yes	

† Qualification standards can be found at International Rectifier’s web site: <http://www.irf.com/product-info/reliability/>

†† Applicable version of JEDEC standard at the time of product release.

**Notes:**

- ① Repetitive rating; pulse width limited by max. junction temperature.
- ② Starting  $T_J = 25^{\circ}\text{C}$ ,  $L = 290\mu\text{H}$ ,  $R_G = 50\Omega$ ,  $I_{AS} = 50\text{A}$ .
- ③ Pulse width  $\leq 400\mu\text{s}$ ; duty cycle  $\leq 2\%$ .
- ④  $R_{\theta}$  is measured at  $T_J$  of approximately  $90^{\circ}\text{C}$ .
- ⑤ When mounted on 1 inch square PCB (FR-4). Please refer to AN-994 for more details:  
<http://www.irf.com/technical-info/appnotes/an-994.pdf>

**Revision History**

Date	Comments
3/13/2014	<ul style="list-style-type: none"> <li>• Updated the EAS specification on pages 2 &amp; 8.</li> <li>• Updated the Zth data used on figure 11, page 4.</li> <li>• Updated figures 8, 11, 12, &amp; 14 on pages 4 &amp; 5.</li> </ul>
6/26/2014	<ul style="list-style-type: none"> <li>• Update package limit current to 123A and Fig.8 &amp; 9 on page 4</li> </ul>
09/25/2014	<ul style="list-style-type: none"> <li>• Corrected Min Gfs from 280S to 117S on page 2</li> <li>• Updated PQFN 5 x6 Outline “B” Tape and Reel on page 8</li> </ul>
10/20/2014	<ul style="list-style-type: none"> <li>• Typo error—Deleted Note # 6 from page 1 and Diode Characteristic Table on page 2</li> </ul>
3/17/2015	<ul style="list-style-type: none"> <li>• Updated package outline on pages 7.</li> </ul>

单击下面可查看定价，库存，交付和生命周期等信息

[>>Infineon Technologies\(英飞凌\)](#)