

**Key Parameters**

$V_{DRM} / V_{RRM}$	1200V - 1600V
$I_{TAVM}$	600A ( $T_C=85^\circ\text{C}$ )
$I_{TSM}$	17000A
$V_{TO}$	0,9V
$r_T$	0,27m $\Omega$
$R_{thJC}$	0,062K/W
Base plate	50mm



For type designation please refer to actual short form catalog

<http://www.ifbip.com/catalog>

**Merkmale**

- Druckkontakt-Technologie für hohe Zuverlässigkeit
- Industrie-Standard-Gehäuse
- Elektrisch isolierte Bodenplatte

**Features**

- Pressure contact technology for high reliability
- Industrial standard package
- Electrically insulated base plate

**Typische Anwendungen**

- Sanftanlasser
- Gleichrichter für Antriebsapplikationen
- Kurzschließer-Applikationen
- Leistungssteller
- Gleichrichter für UPS
- Batterieladegleichrichter
- Statische Umschalter
- Bypass-Schalter

**Typical Applications**

- Soft starter
- Rectifier for drives applications
- Crowbar applications
- Power controllers
- Rectifiers for UBS
- Battery chargers
- Static switches
- Bypass switch

content of customer DMX code	DMX code digit	DMX code digit quantity
serial number	1..5	5
SAP material number	6..12	7
Internal production order number	13..20	8
datecode (production year)	21..22	2
datecode (production week)	23..24	2

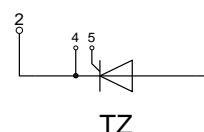

[www.ifbip.com](http://www.ifbip.com)  
[support@infineon-bip.com](mailto:support@infineon-bip.com)



## TZ600N

## Elektrische Eigenschaften / Electrical properties

## Höchstzulässige Werte / Maximum rated values

Periodische Vorwärts- und Rückwärts-Spitzenspannung repetitive peak forward off-state and reverse voltages	$T_{vj} = -40^{\circ}\text{C} \dots T_{vj\text{max}}$	$V_{\text{DRM}}, V_{\text{RRM}}$	1200 1400 1600	V V
Vorwärts-Stoßspitzenspannung non-repetitive peak forward off-state voltage	$T_{vj} = -40^{\circ}\text{C} \dots T_{vj\text{max}}$	$V_{\text{DSM}}$	1200 1400 1600	V V
Rückwärts-Stoßspitzenspannung non-repetitive peak reverse voltage	$T_{vj} = +25^{\circ}\text{C} \dots T_{vj\text{max}}$	$V_{\text{RSM}}$	1300 1500 1700	V
Durchlaßstrom-Grenzeffektivwert maximum RMS on-state current		$I_{\text{TRMSM}}$	1050	A
Dauergrenzstrom average on-state current	$T_{\text{C}} = 85^{\circ}\text{C}$ $T_{\text{C}} = 77^{\circ}\text{C}$	$I_{\text{TAVM}}$	600 669	A A
Stoßstrom-Grenzwert surge current	$T_{vj} = 25^{\circ}\text{C}, t_{\text{p}} = 10\text{ ms}$ $T_{vj} = T_{vj\text{max}}, t_{\text{p}} = 10\text{ ms}$	$I_{\text{TSM}}$	17.000 14.000	A A
Grenzlastintegral $I^2t$ -value	$T_{vj} = 25^{\circ}\text{C}, t_{\text{p}} = 10\text{ ms}$ $T_{vj} = T_{vj\text{max}}, t_{\text{p}} = 10\text{ ms}$	$I^2t$	1.445.000 980.000	$\text{A}^2\text{s}$ $\text{A}^2\text{s}$
Kritische Stromsteilheit critical rate of rise of on-state current	DIN IEC 747-6 $f = 50\text{ Hz}, i_{\text{GM}} = 1\text{ A}, di_{\text{G}}/dt = 1\text{ A}/\mu\text{s}$	$(di_{\text{T}}/dt)_{\text{cr}}$	200	$\text{A}/\mu\text{s}$
Kritische Spannungssteilheit critical rate of rise of off-state voltage	$T_{vj} = T_{vj\text{max}}, V_{\text{D}} = 0,67 V_{\text{DRM}}$ 6.Kennbuchstabe / 6 <sup>th</sup> letter F	$(dv_{\text{D}}/dt)_{\text{cr}}$	1000	$\text{V}/\mu\text{s}$

## Charakteristische Werte / Characteristic values

Durchlaßspannung on-state voltage	$T_{vj} = T_{vj\text{max}}, i_{\text{T}} = 1700\text{ A}$	$v_{\text{T}}$	max. 1,53	V
Schleusenspannung threshold voltage	$T_{vj} = T_{vj\text{max}}$	$V_{(\text{TO})}$	0,9	V
Ersatzwiderstand slope resistance	$T_{vj} = T_{vj\text{max}}$	$r_{\text{T}}$	0,27	$\text{m}\Omega$
Zündstrom gate trigger current	$T_{vj} = 25^{\circ}\text{C}, V_{\text{D}} = 6\text{ V}$	$I_{\text{GT}}$	max. 250	mA
Zündspannung gate trigger voltage	$T_{vj} = 25^{\circ}\text{C}, V_{\text{D}} = 6\text{ V}$	$V_{\text{GT}}$	max. 2,2	V
Nicht zündender Steuerstrom gate non-trigger current	$T_{vj} = T_{vj\text{max}}, V_{\text{D}} = 6\text{ V}$ $T_{vj} = T_{vj\text{max}}, V_{\text{D}} = 0,5 V_{\text{DRM}}$	$I_{\text{GD}}$	max. 10 max. 5	mA mA
Nicht zündende Steuerspannung gate non-trigger voltage	$T_{vj} = T_{vj\text{max}}, V_{\text{D}} = 0,5 V_{\text{DRM}}$	$V_{\text{GD}}$	max. 0,25	V
Haltestrom holding current	$T_{vj} = 25^{\circ}\text{C}, V_{\text{D}} = 6\text{ V}, R_{\text{A}} = 5\ \Omega$	$I_{\text{H}}$	max. 300	mA
Einraststrom latching current	$T_{vj} = 25^{\circ}\text{C}, V_{\text{D}} = 6\text{ V}, R_{\text{GK}} \geq 10\ \Omega$ $i_{\text{GM}} = 1\text{ A}, di_{\text{G}}/dt = 1\text{ A}/\mu\text{s}, t_{\text{g}} = 20\ \mu\text{s}$	$I_{\text{L}}$	max. 1500	mA
Vorwärts- und Rückwärts-Sperrstrom forward off-state and reverse current	$T_{vj} = T_{vj\text{max}}$ $V_{\text{D}} = V_{\text{DRM}}, V_{\text{R}} = V_{\text{RRM}}$	$i_{\text{D}}, i_{\text{R}}$	max. 140	mA
Zündverzug gate controlled delay time	DIN IEC 747-6 $T_{vj} = 25^{\circ}\text{C}, i_{\text{GM}} = 1\text{ A}, di_{\text{G}}/dt = 1\text{ A}/\mu\text{s}$	$t_{\text{gd}}$	max. 4	$\mu\text{s}$

prepared by: A. Glunz	date of publication: 2018.07.16
approved by: M. Stelle	revision: 3.4

**Elektrische Eigenschaften / Electrical properties**

Charakteristische Werte / Characteristic values

Freiwerdezeit circuit commutated turn-off time	$T_{vj} = T_{vj\max}$ , $i_{TM} = I_{TAVM}$ $V_{RM} = 100\text{ V}$ , $V_{DM} = 0,67 V_{DRM}$ $dv_D/dt = 20\text{ V}/\mu\text{s}$ , $-di_T/dt = 10\text{ A}/\mu\text{s}$ 5.Kennbuchstabe / 5 <sup>th</sup> letter O	$t_q$	typ.	250	$\mu\text{s}$
Isolations-Prüfspannung insulation test voltage	RMS, $f = 50\text{ Hz}$ , $t = 1\text{ min}$ RMS, $f = 50\text{ Hz}$ , $t = 1\text{ sec}$	$V_{ISOL}$		3,0 3,6	kV kV

**Thermische Eigenschaften / Thermal properties**

Innerer Wärmewiderstand thermal resistance, junction to case	pro Modul / per Module, $\Theta = 180^\circ \sin$ pro Modul / per Module, DC	$R_{thJC}$	max.	0,065	$^\circ\text{C}/\text{W}$
			max.	0,062	$^\circ\text{C}/\text{W}$
Übergangs-Wärmewiderstand thermal resistance, case to heatsink	pro Modul / per Module	$R_{thCH}$	max.	0,02	$^\circ\text{C}/\text{W}$
Höchstzulässige Sperrschichttemperatur maximum junction temperature		$T_{vj\max}$		135	$^\circ\text{C}$
Betriebstemperatur operating temperature		$T_{c\text{ op}}$		-40...+135	$^\circ\text{C}$
Lagertemperatur storage temperature		$T_{stg}$		-40...+140	$^\circ\text{C}$

**Mechanische Eigenschaften / Mechanical properties**

Gehäuse, siehe Anlage case, see annex				Seite 4 page 4	
Si-Element mit Druckkontakt Si-pellet with pressure contact					
Innere Isolation internal insulation				AIN	
Anzugsdrehmoment für mechanische Anschlüsse mounting torque	Toleranz / Tolerance $\pm 15\%$	M1		5	Nm
Anzugsdrehmoment für elektrische Anschlüsse terminal connection torque	Toleranz / Tolerance $\pm 10\%$	M2		12	Nm
Steueranschlüsse control terminals	DIN 46 244			A 2,8 x 0,8	
Gewicht weight		G	typ.	900	g
Kriechstrecke creepage distance				15	mm
Schwingfestigkeit vibration resistance	$f = 50\text{ Hz}$			50	$\text{m}/\text{s}^2$
	file-No.			E 83335	

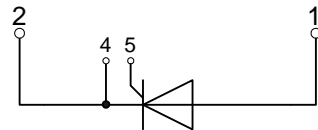
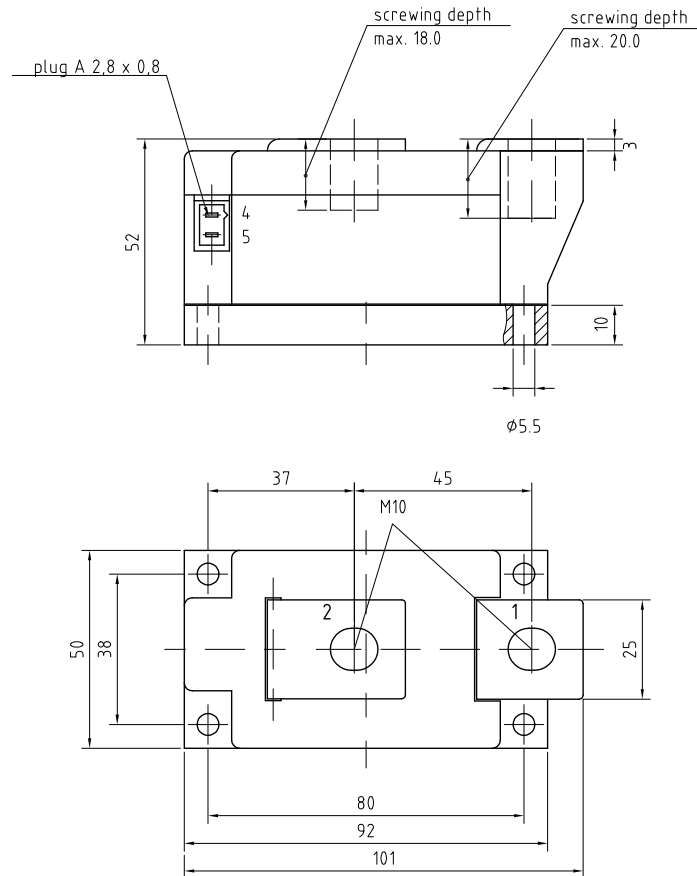
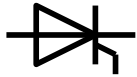

**TZ**

**Analytische Elemente des transienten Wärmewiderstandes  $Z_{thJC}$  für DC**  
**Analytical elements of transient thermal impedance  $Z_{thJC}$  for DC**

Pos. n	1	2	3	4	5	6	7
$R_{thn}$ [°C/W]	0,00137	0,00486	0,0114	0,0223	0,0221		
$\tau_n$ [s]	0,00076	0,0086	0,101	0,56	3,12		

Analytische Funktion / Analytical function: 
$$Z_{thJC} = \sum_{n=1}^{n_{max}} R_{thn} \left( 1 - e^{-\frac{t}{\tau_n}} \right)$$

Luftselbstkühlung / Natural cooling  
3 Module pro Kühlkörper / 3 modules per heatsink  
Kühlkörper / Heatsink type: KM17 (90W)

**Analytische Elemente des transienten Wärmewiderstandes  $Z_{thCA}$**   
**Analytical elements of transient thermal impedance  $Z_{thCA}$** 

Pos. n	1	2	3	4	5	6	7
$R_{thn}$ [°C/W]	0,796	0,005	0,041				
$\tau_n$ [s]	1420	912	12				

Verstärkte Kühlung / Forced cooling  
3 Module pro Kühlkörper / 3 modules per heatsink  
Kühlkörper / Heatsink type: KM17 (Papst 4650N)

**Analytische Elemente des transienten Wärmewiderstandes  $Z_{thCA}$**   
**Analytical elements of transient thermal impedance  $Z_{thCA}$** 

Pos. n	1	2	3	4	5	6	7
$R_{thn}$ [°C/W]	0,239	0,0435	0,0075				
$\tau_n$ [s]	497	31,8	6,4				

Analytische Funktion / Analytical function: 
$$Z_{thCA} = \sum_{n=1}^{n_{max}} R_{thn} \left( 1 - e^{-\frac{t}{\tau_n}} \right)$$

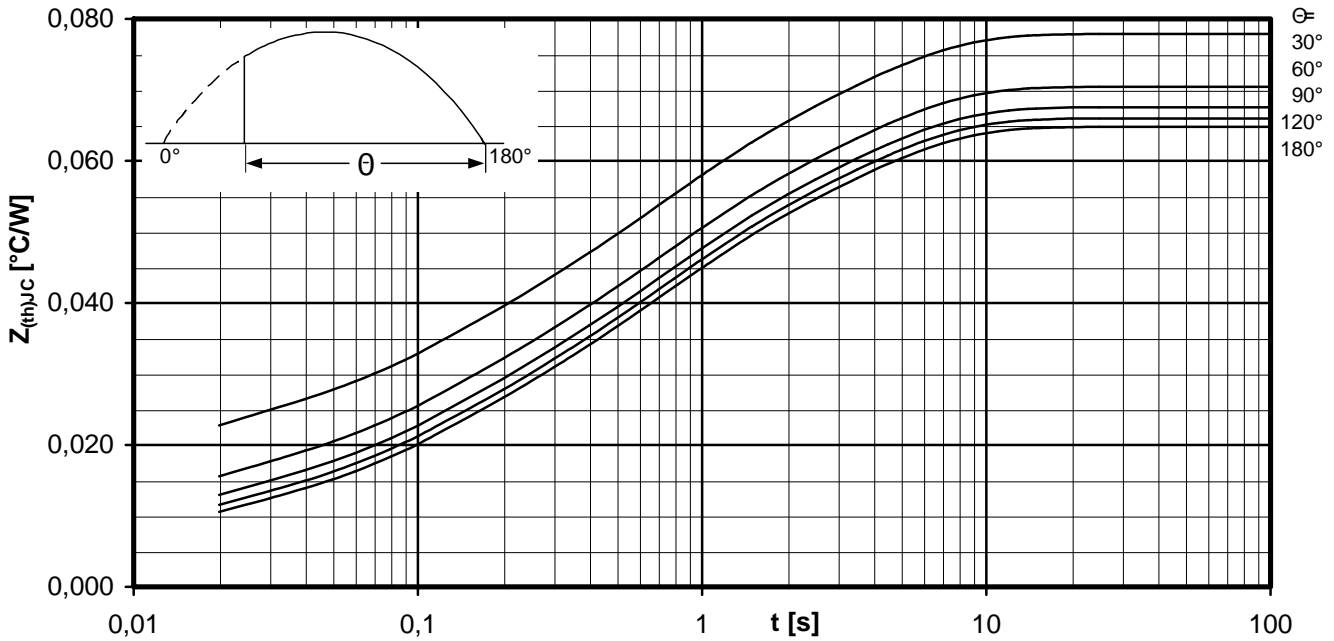
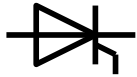

Transienter innerer Wärmewiderstand je Zweig / Transient thermal impedance per arm  $Z_{thJC} = f(t)$

Sinusförmiger Strom / Sinusoidal current

Parameter: Stromflußwinkel  $\Theta$  / Current conduction angle  $\Theta$

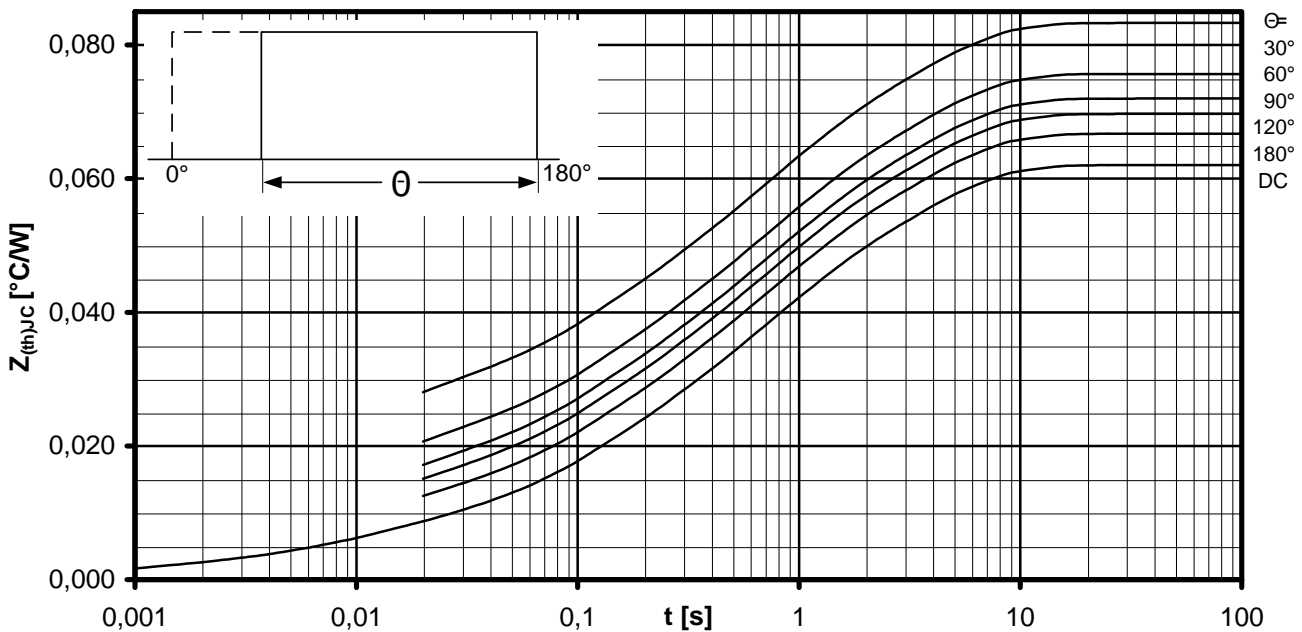

Transienter innerer Wärmewiderstand je Zweig / Transient thermal impedance per arm  $Z_{thJC} = f(t)$

Rechteckförmiger Strom / Rectangular current

Parameter: Stromflußwinkel  $\Theta$  / Current conduction angle  $\Theta$

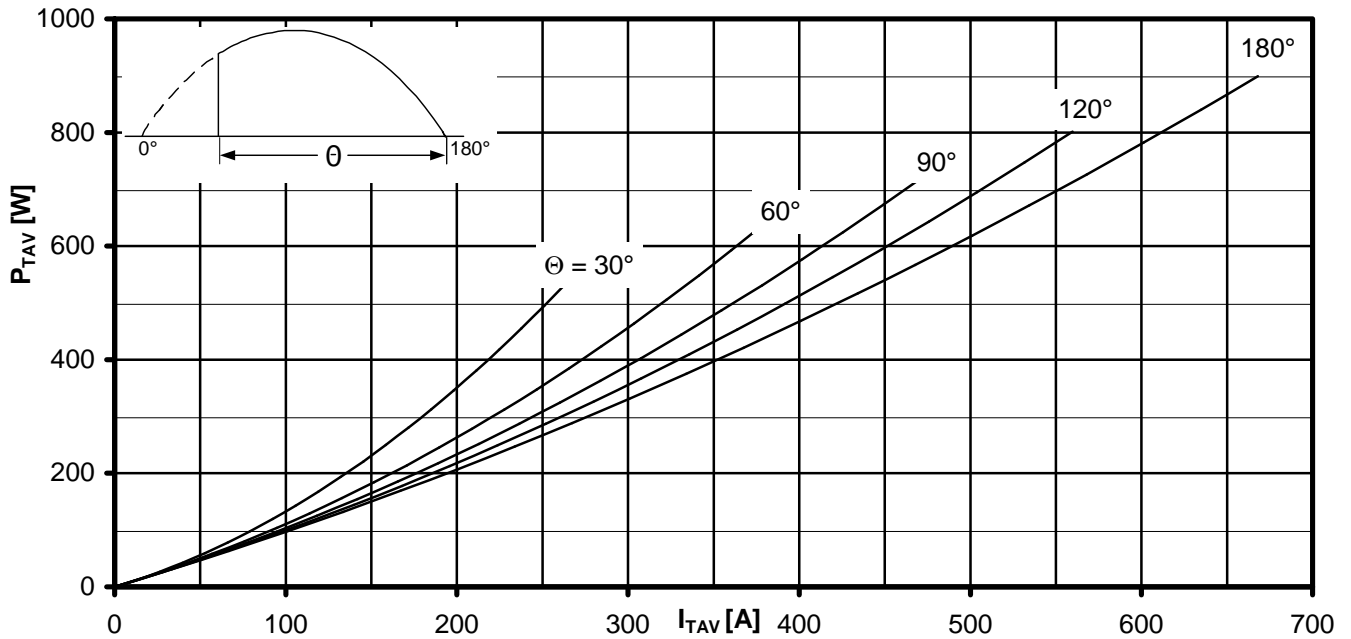
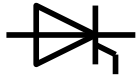

Durchlassverlustleistung je Zweig / On-state power loss per arm  $P_{TAV} = f(I_{TAV})$

Sinusförmiger Strom / Sinusoidal current    Strombelastung je Zweig / Current load per arm

Parameter: Stromflußwinkel / Current conduction angle  $\Theta$

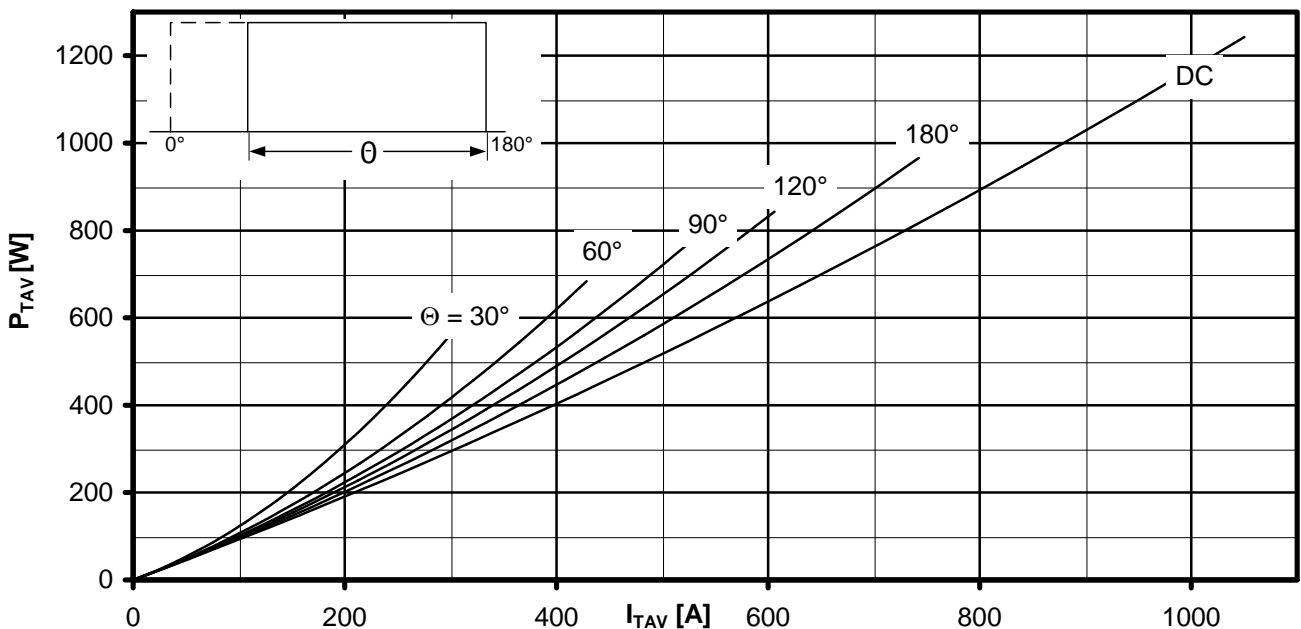

Durchlassverlustleistung je Zweig / On-state power loss per arm  $P_{TAV} = f(I_{TAV})$

Rechteckförmiger Strom / Rectangular current    Strombelastung je Zweig / Current load per arm

Parameter: Stromflußwinkel / Current conduction angle  $\Theta$

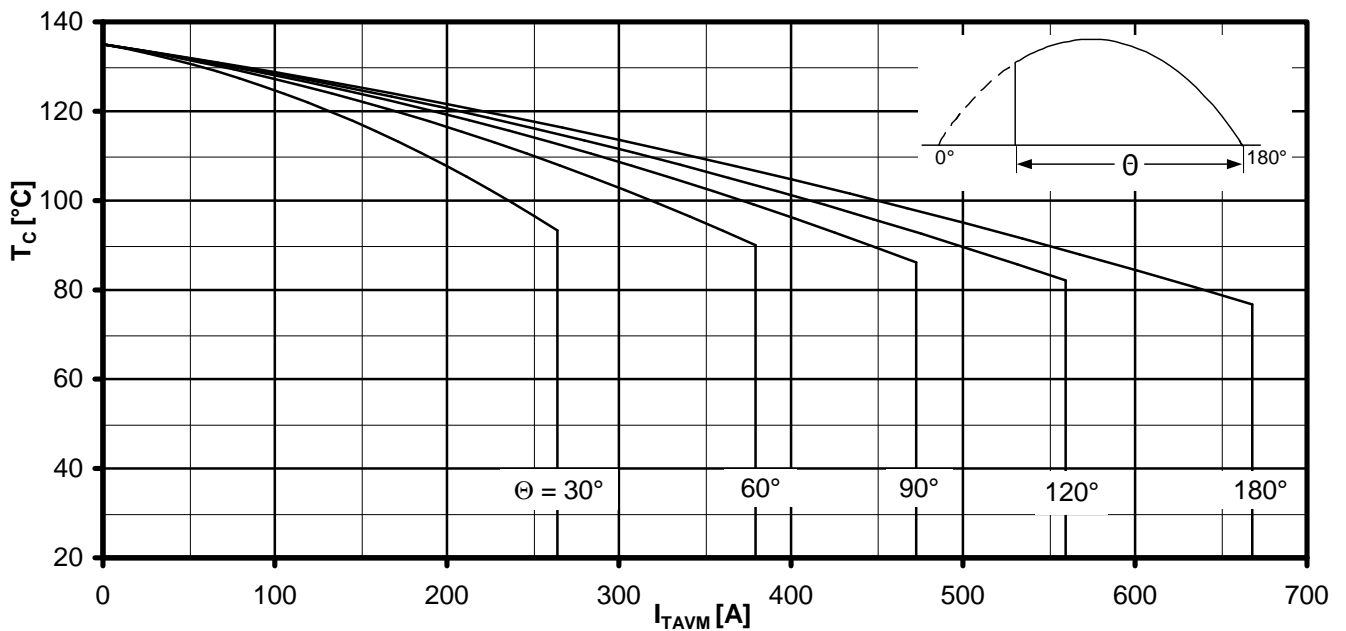

Höchstzulässige Gehäusetemperatur / Maximum allowable case temperature  $T_C = f(I_{TAVM})$

Sinusförmiger Strom / Sinusoidal current Strombelastung je Zweig / Current load per arm

Parameter: Stromflußwinkel  $\Theta$  / Current conduction angle  $\Theta$

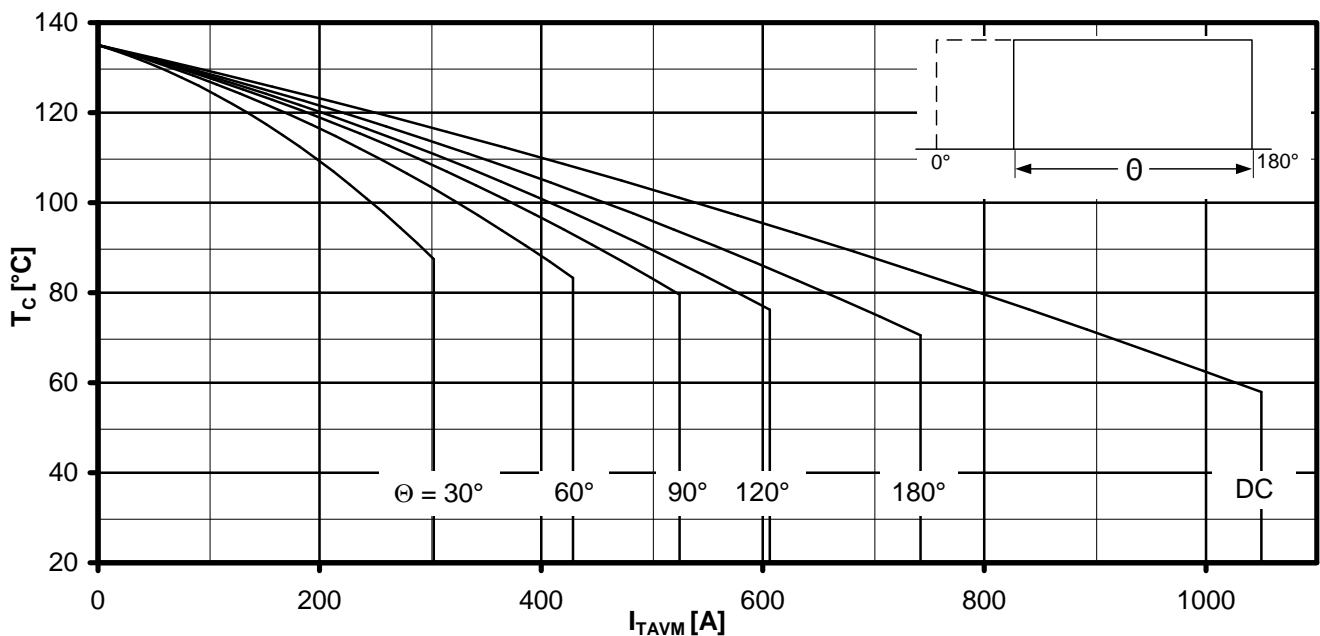

Höchstzulässige Gehäusetemperatur / Maximum allowable case temperature  $T_C = f(I_{TAVM})$

Rechteckförmiger Strom / Rectangular current Strombelastung je Zweig / Current load per arm

Parameter: Stromflußwinkel  $\Theta$  / Current conduction angle  $\Theta$



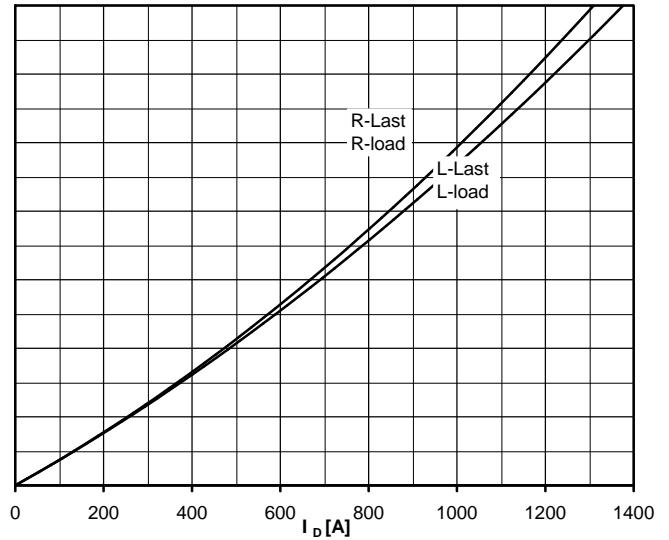
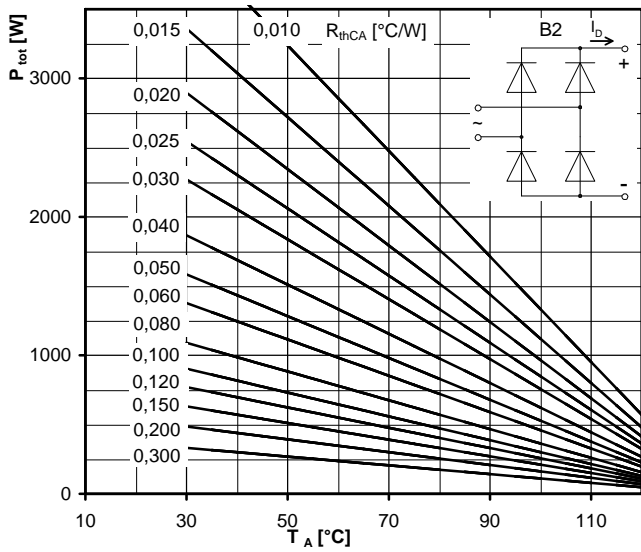

Höchstzulässiger Ausgangsstrom / Maximum rated output current  $I_D$

B2- Zweipuls-Brückenschaltung / Two-pulse bridge circuit

Gesamtverlustleistung der Schaltung / Total power dissipation at circuit  $P_{tot}$

Parameter:

Wärmewiderstand zwischen den Gehäusen und Umgebung / Thermal resistance cases to ambient  $R_{thCA}$

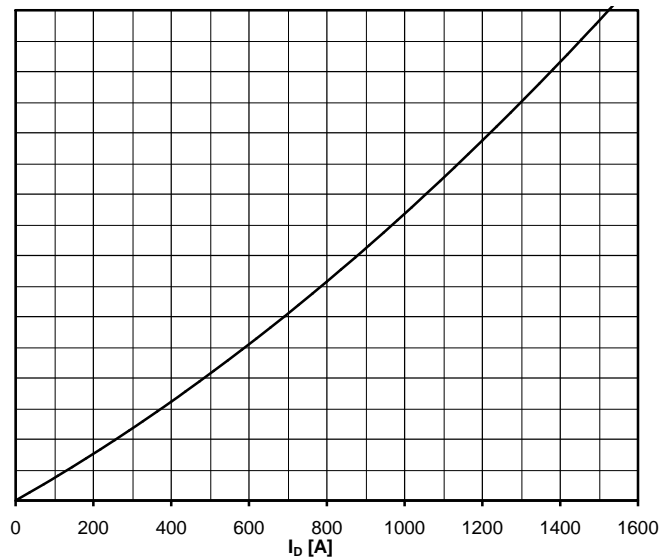
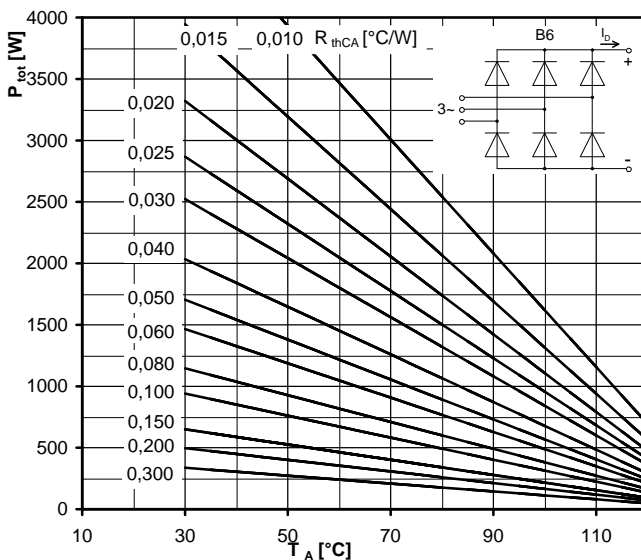

Höchstzulässiger Ausgangsstrom / Maximum rated output current  $I_D$

B6- Sechspuls-Brückenschaltung / Six-pulse bridge circuit

Gesamtverlustleistung der Schaltung / Total power dissipation at circuit  $P_{tot}$

Parameter:

Wärmewiderstand zwischen den Gehäusen und Umgebung / Thermal resistance cases to ambient  $R_{thCA}$



**Netz-Thyristor-Modul**  
**Phase Control Thyristor Module**

## TZ600N

Infineon Technologies Bipolar  
GmbH & Co. KG

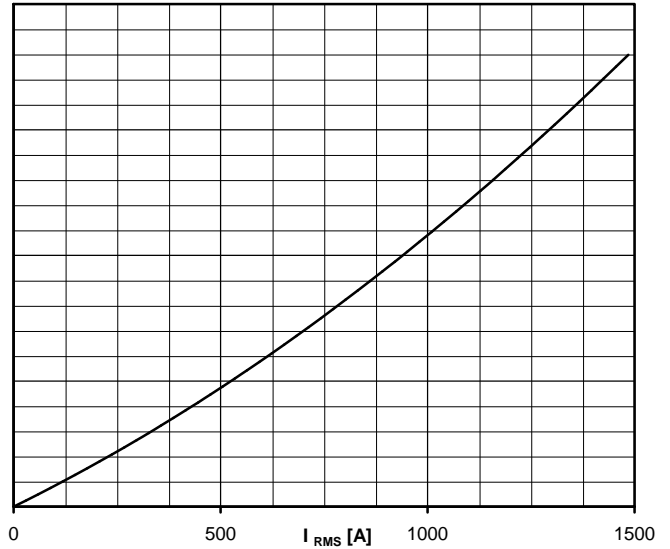
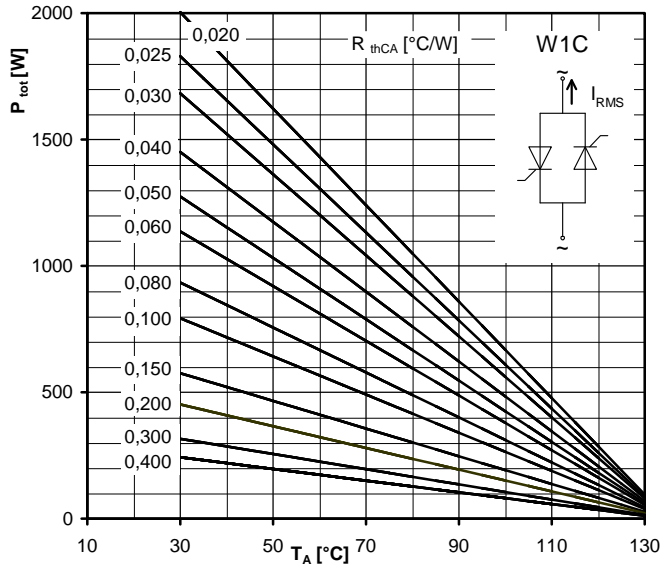

**Höchstzulässiger Effektivstrom / Maximum rated RMS current  $I_{RMS}$**

W1C - Einphasen-Wechselwegschtaltung / Single-phase inverse parallel circuit

Gesamtverlustleistung der Schaltung / Total power dissipation at circuit  $P_{tot}$

Parameter:

Wärmewiderstand zwischen den Gehäusen und Umgebung / Thermal resistance case to ambient  $R_{thCA}$

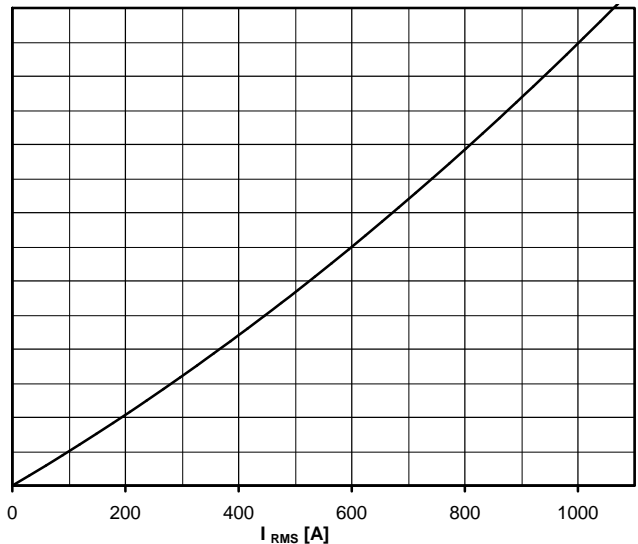
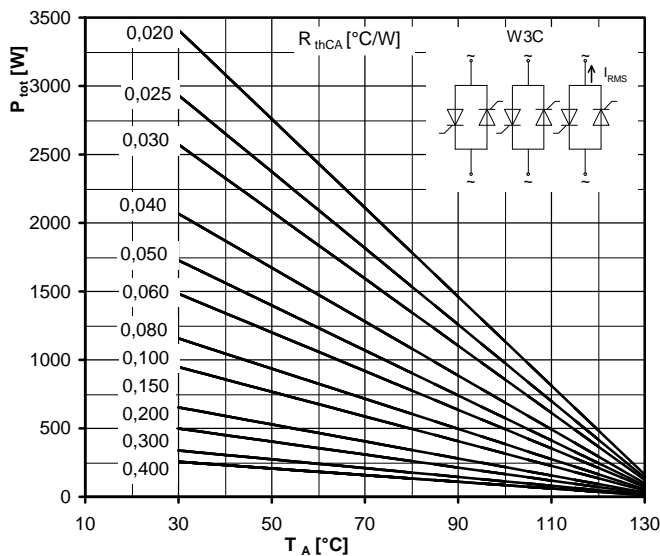

**Höchstzulässiger Effektivstrom / Maximum rated RMS current  $I_{RMS}$**

W3C - Dreiphasen-Wechselwegschtaltung / Three-phase inverse parallel circuit

Gesamtverlustleistung der Schaltung / Total power dissipation at circuit  $P_{tot}$

Parameter:

Wärmewiderstand zwischen den Gehäusen und Umgebung / Thermal resistance cases to ambient  $R_{thCA}$

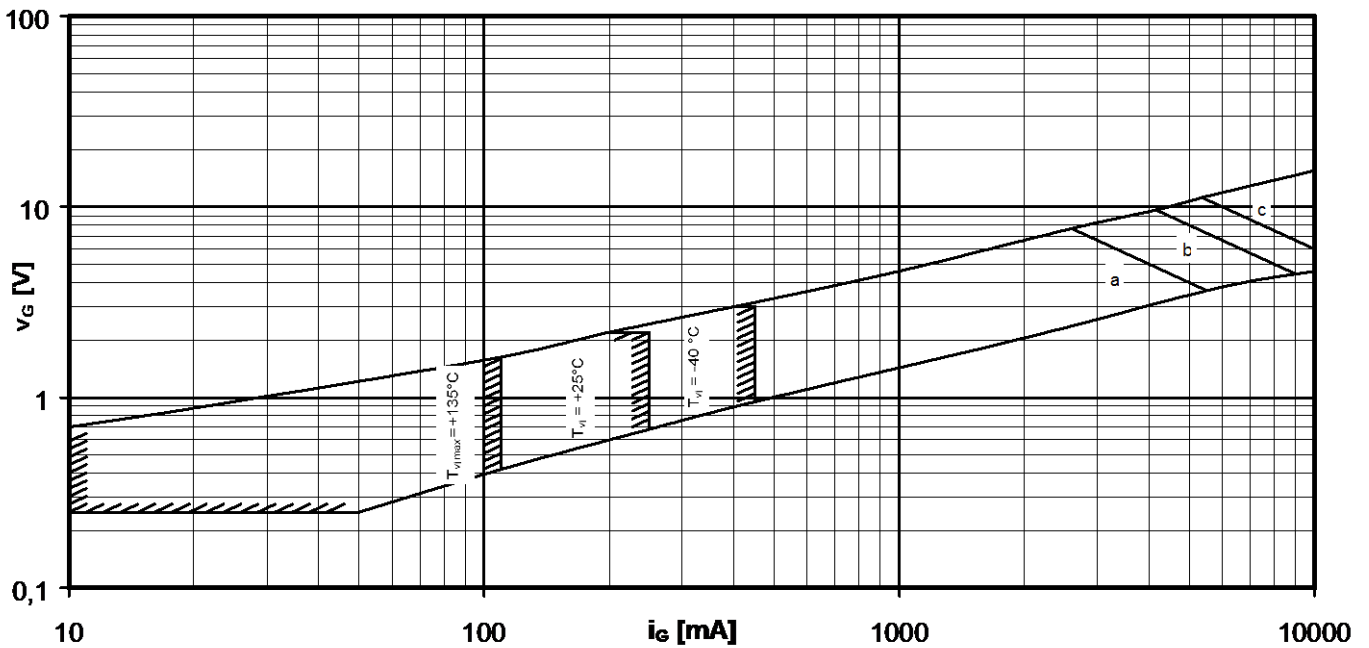
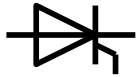

Steuercharakteristik  $v_G = f(i_G)$  mit Zündbereichen für  $V_D = 6\text{ V}$   
Gate characteristic  $v_G = f(i_G)$  with triggering area for  $V_D = 6\text{ V}$

Höchstzulässige Spitzensteuerverlustleistung / Maximum rated peak gate power dissipation  $P_{GM} = f(t_G)$  :

a - 20 W/10ms    b - 40 W/1ms    c - 60 W/0,5ms

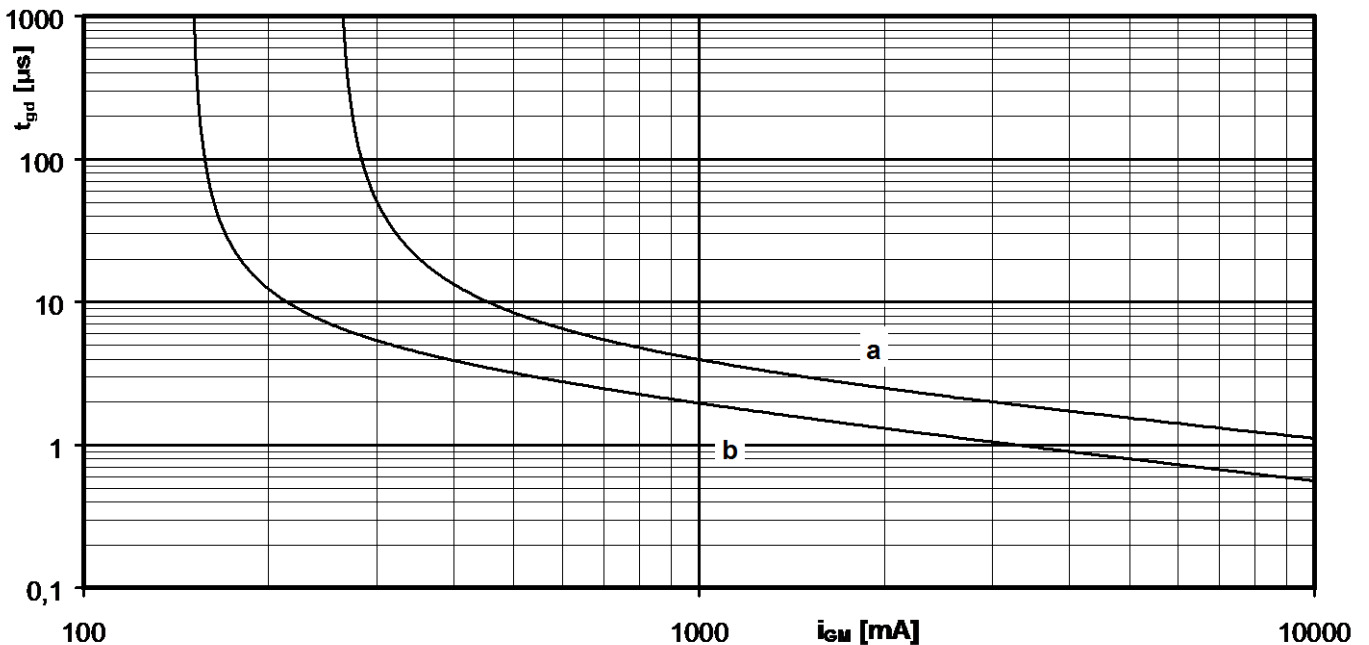

Zündverzögerung / Gate controlled delay time  $t_{gd} = f(i_G)$

$T_{vj} = 25^\circ\text{C}$ ,  $di_G/dt = i_{GM}/1\mu\text{s}$

a - maximaler Verlauf / Limiting characteristic

b - typischer Verlauf / Typical characteristic

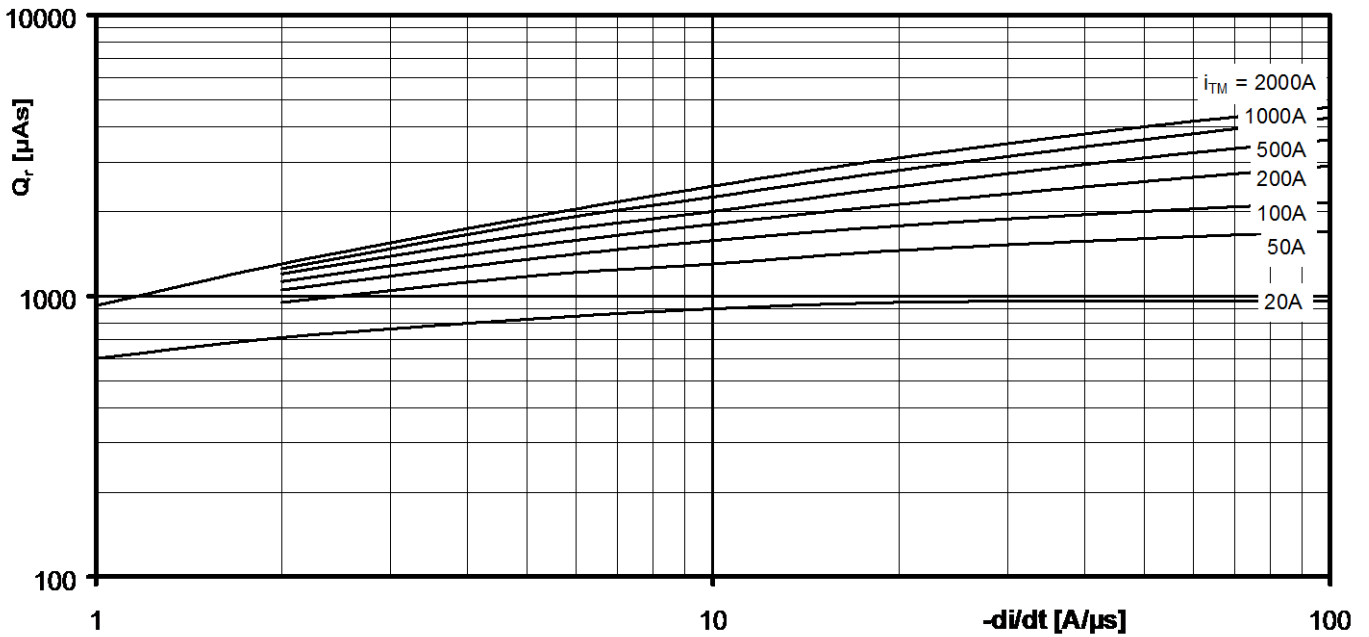
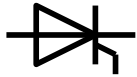

Sperrverzögerungsladung / Recovered charge  $Q_r = f(-di/dt)$

$$T_{vj} = T_{vjmax}, v_R \leq 0,5 V_{RRM}, v_{RM} = 0,8 V_{RRM}$$

Parameter: Durchlaßstrom / On-state current  $i_{TM}$

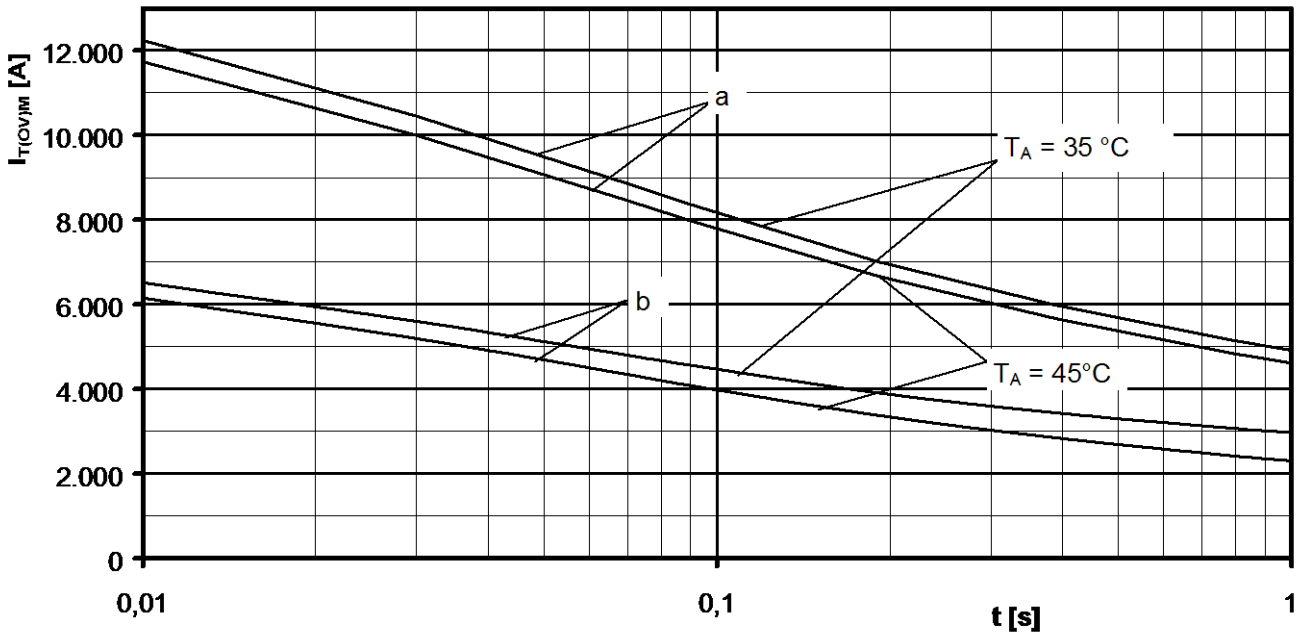

Grenzstrom / Maximum overload on-state current  $I_{T(OV)M} = f(t), v_{RM} = 0,8 V_{RRM}$

a: Leerlauf / No-load conditions

b: nach Belastung mit  $I_{TAVM}$  / after load with  $I_{TAVM}$

$T_A = 35^\circ\text{C}$ , verstärkte Luftkühlung / Forced air cooling

$T_A = 45^\circ\text{C}$ , Luftselbstkühlung / Natural air cooling

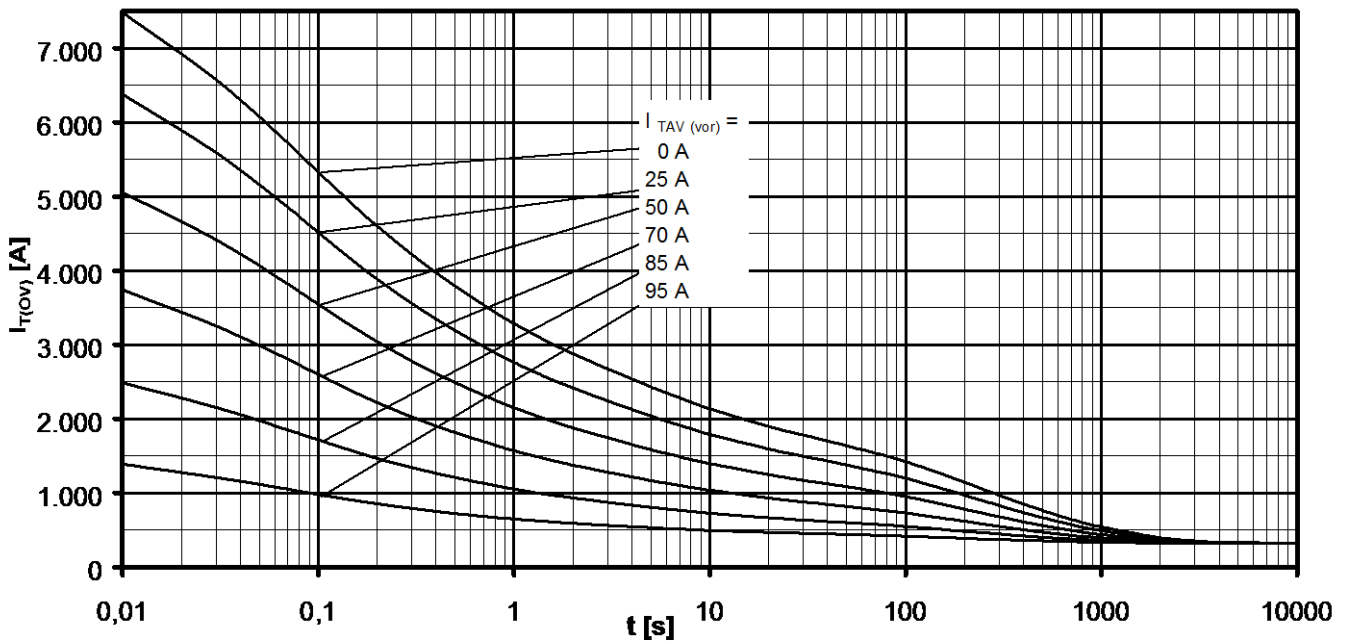

Überstrom je Zweig / Overload on-state current  $I_{T(ov)}$

B6- Sechspuls-Brückenschaltung, 120° Rechteck / Six-pulse bridge circuit, 120° rectangular

Kühlkörper / Heatsink type KM17 (90W)    Luftselbstkühlung bei / Natural cooling at  $T_A = 45^\circ\text{C}$

Parameter: Vorlaststrom je Zweig / Pre-load current per arm  $I_{TAV(vor)}$

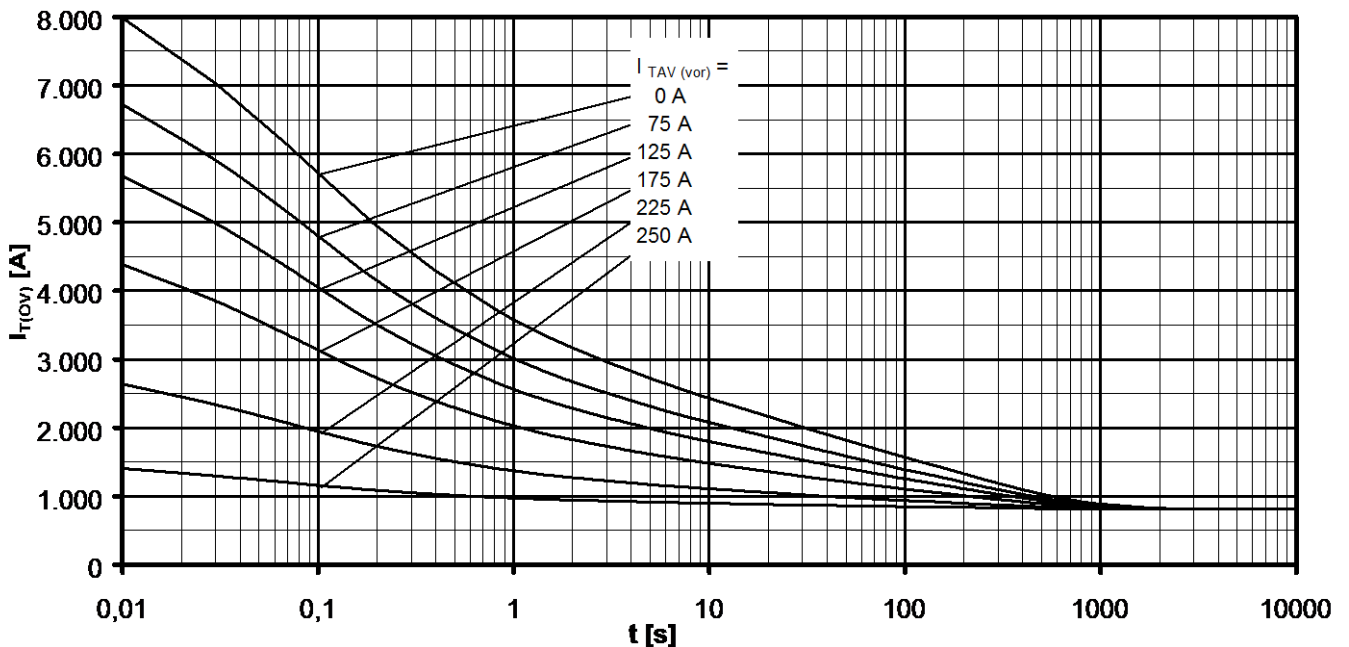

Überstrom je Zweig / Overload on-state current  $I_{T(ov)}$

B6- Sechspuls-Brückenschaltung, 120° Rechteck / Six-pulse bridge circuit, 120° rectangular

Kühlkörper / Heatsink type KM17 (Papst 4650N)    Verstärkte Kühlung bei / Forced cooling at  $T_A = 35^\circ\text{C}$

Parameter: Vorlaststrom je Zweig / Pre-load current per arm  $I_{TAV(vor)}$

单击下面可查看定价，库存，交付和生命周期等信息

[>>Infineon Technologies\(英飞凌\)](#)