

Technische Information / Technical Information

IGBT-Module
IGBT-Modules

FP25R12KS4C

eupec



Elektrische Eigenschaften / Electrical properties

Höchstzulässige Werte / Maximum rated values

Diode Gleichrichter/ Diode Rectifier

Periodische Rückw. Spitzensperrspannung repetitive peak reverse voltage		V_{RRM}	1600	V
Durchlaßstrom Grenzeffektivwert RMS forward current per chip		I_{FRMSM}	40	A
Dauergleichstrom DC forward current	$T_C = 80^\circ\text{C}$	I_d	25	A
Stoßstrom Grenzwert surge forward current	$t_p = 10\text{ ms}, T_{vj} = 25^\circ\text{C}$	I_{FSM}	300	A
	$t_p = 10\text{ ms}, T_{vj} = 150^\circ\text{C}$		230	A
Grenzlastintegral I^2t - value	$t_p = 10\text{ ms}, T_{vj} = 25^\circ\text{C}$	I^2t	450	A^2s
	$t_p = 10\text{ ms}, T_{vj} = 150^\circ\text{C}$		260	A^2s

Transistor Wechselrichter/ Transistor Inverter

Kollektor-Emitter-Sperrspannung collector-emitter voltage		V_{CES}	1200	V
Kollektor-Dauergleichstrom DC-collector current	$T_C = 80^\circ\text{C}$	$I_{C,nom.}$	25	A
	$T_C = 25^\circ\text{C}$	I_C	40	A
Periodischer Kollektor Spitzenstrom repetitive peak collector current	$t_p = 1\text{ ms}, T_C = 80^\circ\text{C}$	I_{CRM}	50	A
Gesamt-Verlustleistung total power dissipation	$T_C = 25^\circ\text{C}$	P_{tot}	230	W
Gate-Emitter-Spitzenspannung gate-emitter peak voltage		V_{GES}	+/- 20V	V

Diode Wechselrichter/ Diode Inverter

Dauergleichstrom DC forward current	$T_C = 80^\circ\text{C}$	I_F	25	A
Periodischer Spitzenstrom repetitive peak forw. current	$t_p = 1\text{ ms}$	I_{FRM}	50	A
Grenzlastintegral I^2t - value	$V_R = 0\text{V}, t_p = 10\text{ms}, T_{vj} = 125^\circ\text{C}$	I^2t	125	A^2s

Transistor Brems-Chopper/ Transistor Brake-Chopper

Kollektor-Emitter-Sperrspannung collector-emitter voltage		V_{CES}	1200	V
Kollektor-Dauergleichstrom DC-collector current	$T_C = 80^\circ\text{C}$	$I_{C,nom.}$	12,5	A
	$T_C = 25^\circ\text{C}$	I_C	25	A
Periodischer Kollektor Spitzenstrom repetitive peak collector current	$t_p = 1\text{ ms}, T_C = 80^\circ\text{C}$	I_{CRM}	25	A
Gesamt-Verlustleistung total power dissipation	$T_C = 25^\circ\text{C}$	P_{tot}	100	W
Gate-Emitter-Spitzenspannung gate-emitter peak voltage		V_{GES}	+/- 20V	V

Diode Brems-Chopper/ Diode Brake-Chopper

Dauergleichstrom DC forward current	$T_C = 80^\circ\text{C}$	I_F	10	A
Periodischer Spitzenstrom repetitive peak forw. current	$t_p = 1\text{ ms}$	I_{FRM}	20	A

prepared by: A.Schulz

date of publication: 2001-11-28

approved by: M.Hierholzer

revision: 2

Technische Information / Technical Information

IGBT-Module
IGBT-Modules

FP25R12KS4C

eupec

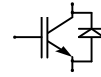

Modul Isolation/ Module Isolation

Isolations-Prüfspannung insulation test voltage	RMS, f = 50 Hz, t = 1 min. NTC connected to Baseplate	V _{ISOL}	2,5	kV
--	--	-------------------	-----	----

Elektrische Eigenschaften / Electrical properties

Charakteristische Werte / Characteristic values

				min.	typ.	max.		
Durchlaßspannung forward voltage	T _{vj} = 150°C,	I _F = 25 A	V _F	-	1,05	-	V	
Schleusenspannung threshold voltage	T _{vj} = 150°C		V _(TO)	-	-	0,8	V	
Ersatzwiderstand slope resistance	T _{vj} = 150°C		r _T	-	-	10,5	mΩ	
Sperrstrom reverse current	T _{vj} = 150°C,	V _R = 1600 V	I _R	-	2	-	mA	
Modul Leitungswiderstand, Anschlüsse-Chip lead resistance, terminals-chip	T _C = 25°C		R _{AA+CC}	-	8	-	mΩ	

Transistor Wechselrichter/ Transistor Inverter

				min.	typ.	max.		
Kollektor-Emitter Sättigungsspannung collector-emitter saturation voltage	V _{GE} = 15V, T _{vj} = 25°C, I _C = 25 A	V _{CE sat}	-	3,2	3,7	V		
	V _{GE} = 15V, T _{vj} = 125°C, I _C = 25 A		-	3,85	-	V		
Gate-Schwellenspannung gate threshold voltage	V _{CE} = V _{GE} , T _{vj} = 25°C, I _C = 1 mA	V _{GE(TO)}	4,5	5,5	6,5	V		
Eingangskapazität input capacitance	f = 1MHz, T _{vj} = 25°C V _{CE} = 25 V, V _{GE} = 0 V	C _{ies}	-	1,5	-	nF		
Kollektor-Emitter Reststrom collector-emitter cut-off current	V _{GE} = 0V, T _{vj} = 25°C, V _{CE} = 1200 V	I _{CES}	-	-	5	mA		
Gate-Emitter Reststrom gate-emitter leakage current	V _{CE} = 0V, V _{GE} = 20V, T _{vj} = 25°C	I _{GES}	-	-	400	nA		
Einschaltverzögerungszeit (ind. Last) turn on delay time (inductive load)	I _C = I _{Nenn} , V _{CC} = 600 V	t _{d,on}	-	60	-	ns		
	V _{GE} = ±15V, T _{vj} = 25°C, R _G = 27 Ohm							
	V _{GE} = ±15V, T _{vj} = 125°C, R _G = 27 Ohm							
Anstiegszeit (induktive Last) rise time (inductive load)	I _C = I _{Nenn} , V _{CC} = 600 V	t _r	-	50	-	ns		
	V _{GE} = ±15V, T _{vj} = 25°C, R _G = 27 Ohm							
	V _{GE} = ±15V, T _{vj} = 125°C, R _G = 27 Ohm							
Abschaltverzögerungszeit (ind. Last) turn off delay time (inductive load)	I _C = I _{Nenn} , V _{CC} = 600 V	t _{d,off}	-	340	-	ns		
	V _{GE} = ±15V, T _{vj} = 25°C, R _G = 27 Ohm							
	V _{GE} = ±15V, T _{vj} = 125°C, R _G = 27 Ohm							
Fallzeit (induktive Last) fall time (inductive load)	I _C = I _{Nenn} , V _{CC} = 600 V	t _f	-	50	-	ns		
	V _{GE} = ±15V, T _{vj} = 25°C, R _G = 27 Ohm							
	V _{GE} = ±15V, T _{vj} = 125°C, R _G = 27 Ohm							
Einschaltverlustenergie pro Puls turn-on energy loss per pulse	I _C = I _{Nenn} , V _{CC} = 600 V V _{GE} = ±15V, T _{vj} = 125°C, R _G = 27 Ohm L _S = 75 nH	E _{on}	-	3,2	-	mWs		
Abschaltverlustenergie pro Puls turn-off energy loss per pulse	I _C = I _{Nenn} , V _{CC} = 600 V V _{GE} = ±15V, T _{vj} = 125°C, R _G = 27 Ohm L _S = 75 nH	E _{off}	-	1,6	-	mWs		
Kurzschlußverhalten SC Data	t _p ≤ 10µs, V _{GE} ≤ 15V, R _G = 27 Ohm T _{vj} ≤ 125°C, V _{CC} = 720 V di/dt = 2000 A/µs	I _{SC}	-	160	-	A		

Technische Information / Technical Information

IGBT-Module
IGBT-Modules

FP25R12KS4C

eupec

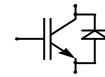

Elektrische Eigenschaften / Electrical properties

Charakteristische Werte / Characteristic values

		min.	typ.	max.		
Modulinduktivität stray inductance module		$L_{\sigma CE}$	-	-	100	nH
Modul Leitungswiderstand, Anschlüsse-Chip lead resistance, terminals-chip	$T_C = 25^\circ C$	R_{CC+EE}	-	11	-	m Ω
Diode Wechselrichter/ Diode Inverter		min.		typ.		max.
Durchlaßspannung forward voltage	$V_{GE} = 0V, T_{vj} = 25^\circ C, I_F = 25 A$ $V_{GE} = 0V, T_{vj} = 125^\circ C, I_F = 25 A$	V_F	-	2,05	2,4	V
Rückstromspitze peak reverse recovery current	$I_F = I_{Nenn}, -di_F/dt = 1000A/\mu s$ $V_{GE} = -10V, T_{vj} = 25^\circ C, V_R = 600 V$ $V_{GE} = -10V, T_{vj} = 125^\circ C, V_R = 600 V$	I_{RM}	-	30	-	A
Sperrverzögerungsladung recovered charge	$I_F = I_{Nenn}, -di_F/dt = 1000A/\mu s$ $V_{GE} = -10V, T_{vj} = 25^\circ C, V_R = 600 V$ $V_{GE} = -10V, T_{vj} = 125^\circ C, V_R = 600 V$	Q_r	-	2,1	-	μAs μAs
Abschaltenergie pro Puls reverse recovery energy	$I_F = I_{Nenn}, -di_F/dt = 1000A/\mu s$ $V_{GE} = -10V, T_{vj} = 25^\circ C, V_R = 600 V$ $V_{GE} = -10V, T_{vj} = 125^\circ C, V_R = 600 V$	E_{RQ}	-	0,75	-	mWs mWs
Transistor Brems-Chopper/ Transistor Brake-Chopper		min.		typ.		max.
Kollektor-Emitter Sättigungsspannung collector-emitter saturation voltage	$V_{GE} = 15V, T_{vj} = 25^\circ C, I_C = 12,5 A$ $V_{GE} = 15V, T_{vj} = 125^\circ C, I_C = 12,5 A$	$V_{CE sat}$	-	2,7	3,15	V
Gate-Schwellenspannung gate threshold voltage	$V_{CE} = V_{GE}, T_{vj} = 25^\circ C, I_C = 0,35mA$	$V_{GE(TO)}$	4,5	5,5	6,5	V
Eingangskapazität input capacitance	$f = 1MHz, T_{vj} = 25^\circ C$ $V_{CE} = 25 V, V_{GE} = 0 V$	C_{ies}	-	0,6	-	nF
Kollektor-Emitter Reststrom collector-emitter cut-off current	$V_{GE} = 0V, T_{vj} = 25^\circ C, V_{CE} = 1200 V$ $V_{GE} = 0V, T_{vj} = 125^\circ C, V_{CE} = 1200 V$	I_{CES}	-	0,5	500	μA mA
Gate-Emitter Reststrom gate-emitter leakage current	$V_{CE} = 0V, V_{GE} = 20V, T_{vj} = 25^\circ C$	I_{GES}	-	-	300	nA
Schaltverluste und -bedingungen Switching losses and conditions	siehe Datenblatt (Wechselrichter) see datasheet (inverter)	BSM10GP120				
Diode Brems-Chopper/ Diode Brake-Chopper		min.		typ.		max.
Durchlaßspannung forward voltage	$T_{vj} = 25^\circ C, I_F = 12,5 A$ $T_{vj} = 125^\circ C, I_F = 12,5 A$	V_F	-	2,35	2,65	V
Schaltverluste und -bedingungen Switching losses and conditions	siehe Datenblatt (Wechselrichter) see datasheet (inverter)	BSM10GP120				
NTC-Widerstand/ NTC-Thermistor		min.		typ.		max.
Nennwiderstand rated resistance	$T_C = 25^\circ C$	R_{25}	-	5	-	k Ω
Abweichung von R_{100} deviation of R_{100}	$T_C = 100^\circ C, R_{100} = 493 \Omega$	$\Delta R/R$	-5		5	%
Verlustleistung power dissipation	$T_C = 25^\circ C$	P_{25}			20	mW
B-Wert B-value	$R_2 = R_1 \exp [B(1/T_2 - 1/T_1)]$	$B_{25/50}$		3375		K

Technische Information / Technical Information

IGBT-Module
IGBT-Modules

FP25R12KS4C

eupec

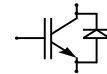

Thermische Eigenschaften / Thermal properties

				min.	typ.	max.	
Innerer Wärmewiderstand thermal resistance, junction to case	Gleichr. Diode/ Rectif. Diode	R_{thJC}	-	-	1	K/W	
	Trans. Wechr./ Trans. Inverter		-	-	0,55	K/W	
	Diode Wechr./ Diode Inverter		-	-	1,2	K/W	
	Trans. Bremse/ Trans. Brake		-	-	1,2	K/W	
	Diode Bremse/ Diode Brake		-	-	2,3	K/W	
Übergangs-Wärmewiderstand thermal resistance, case to heatsink	Gleichr. Diode/ Rectif. Diode	R_{thCK}	-	0,08	-	K/W	
	Trans. Wechr./ Trans. Inverter	$\lambda_{Paste}=1W/m^2K$	-	0,04	-	K/W	
	Diode Wechr./ Diode Inverter	$\lambda_{grease}=1W/m^2K$	-	0,08	-	K/W	
Höchstzulässige Sperrschichttemperatur maximum junction temperature		$T_{vj\ max}$	-	-	150	°C	
Betriebstemperatur operation temperature		$T_{vj\ op}$	-40	-	125	°C	
Lagertemperatur storage temperature		T_{stg}	-40	-	125	°C	

Mechanische Eigenschaften / Mechanical properties

Innere Isolation internal insulation				Al_2O_3	
CTI comperative tracking index				225	
Anzugsdrehmoment f. mech. Befestigung mounting torque		M		3 $\pm 10\%$	Nm
Gewicht weight		G		180	g



Ausgangskennlinienfeld Wechselr. (typisch)

$I_C = f(V_{CE})$

Output characteristic Inverter (typical)

$V_{GE} = 15\text{ V}$

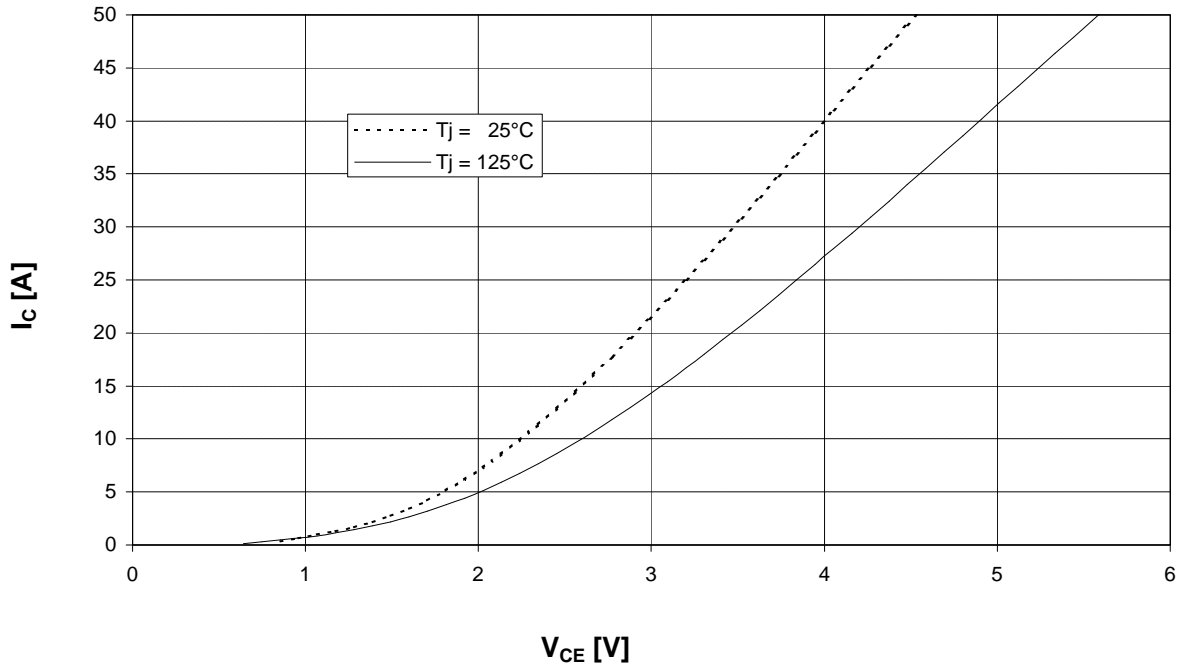

Ausgangskennlinienfeld Wechselr. (typisch)

$I_C = f(V_{CE})$

Output characteristic Inverter (typical)

$T_{vj} = 125^\circ\text{C}$

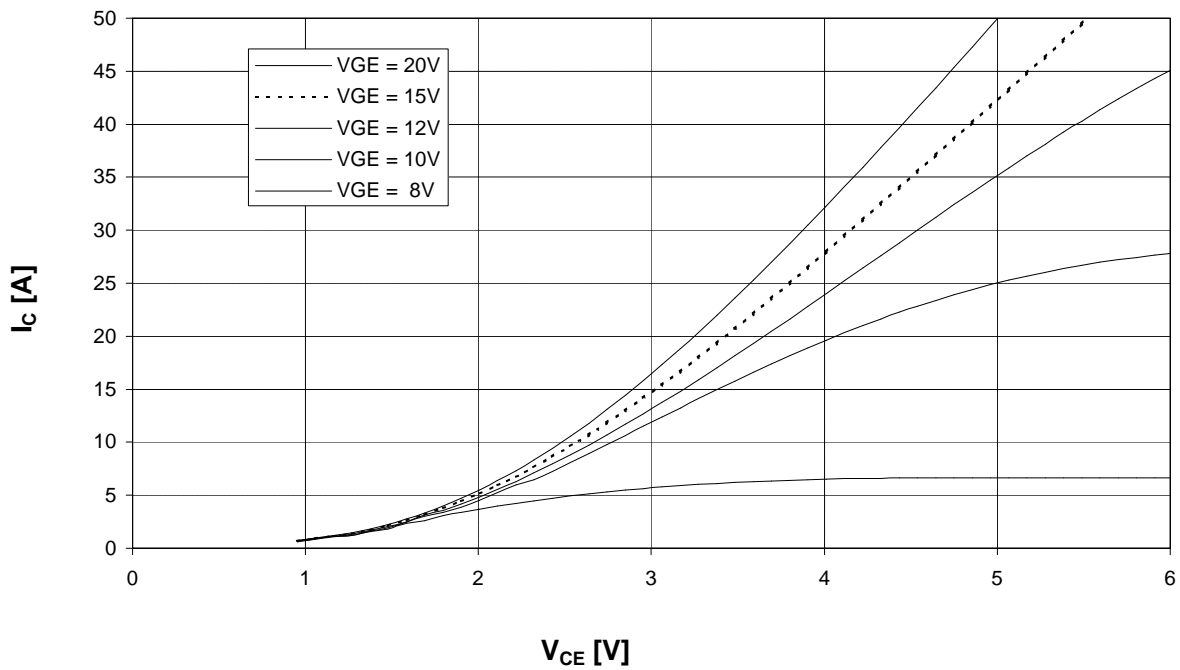

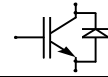

Übertragungscharakteristik Wechselr. (typisch)

$I_C = f(V_{GE})$

Transfer characteristic Inverter (typical)

$V_{CE} = 20\text{ V}$

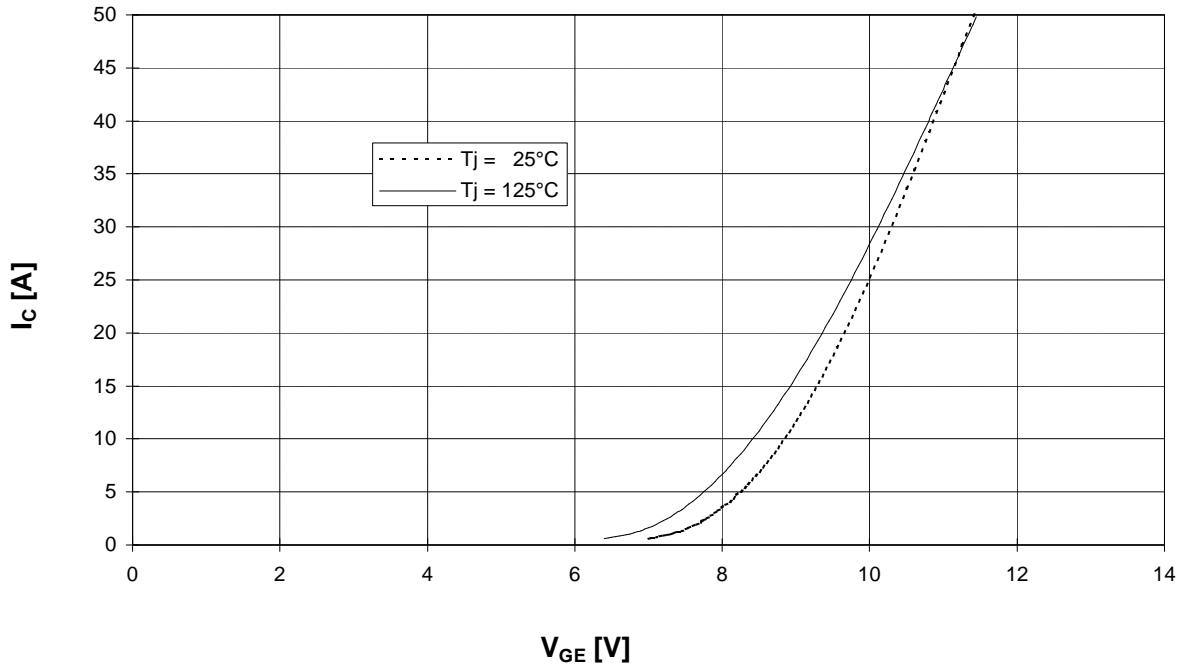

Durchlaßkennlinie der Freilaufdiode Wechselr. (typisch)

$I_F = f(V_F)$

Forward characteristic of FWD Inverter (typical)

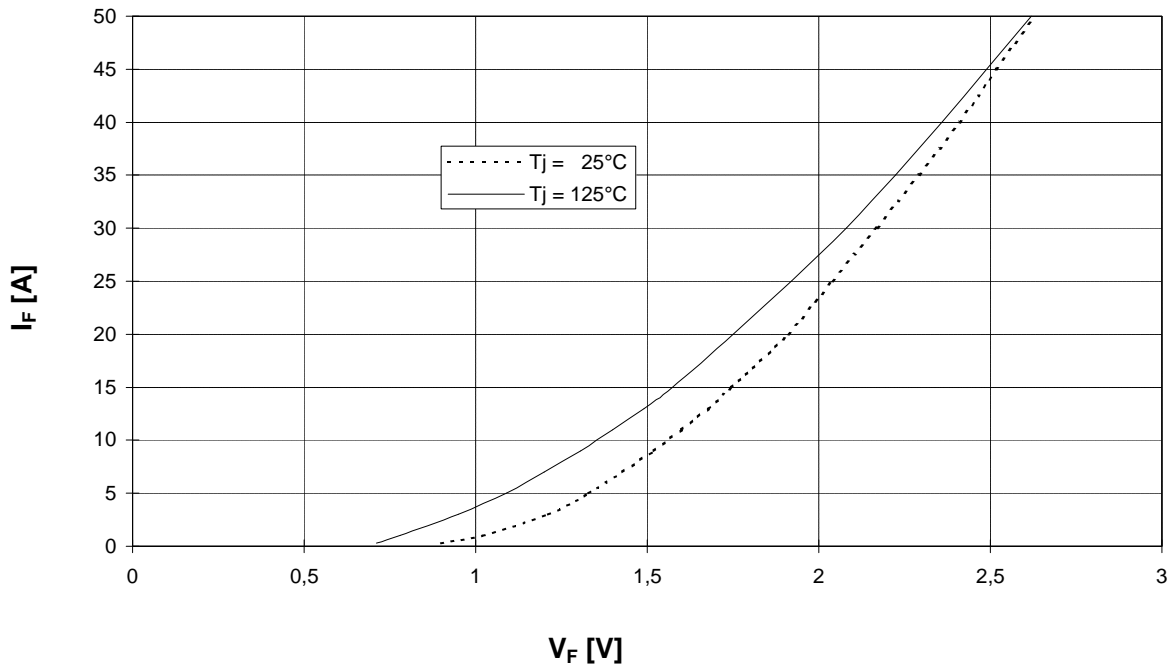

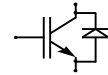

Schaltverluste Wechselr. (typisch) $E_{on} = f(I_c), E_{off} = f(I_c), E_{rec} = f(I_c)$ $V_{CC} = 600\text{ V}$
Switching losses Inverter (typical) $T_j = 125^\circ\text{C}, V_{GE} = \pm 15\text{ V}, R_{Gon} = R_{Goff} = 27\text{ Ohm}$

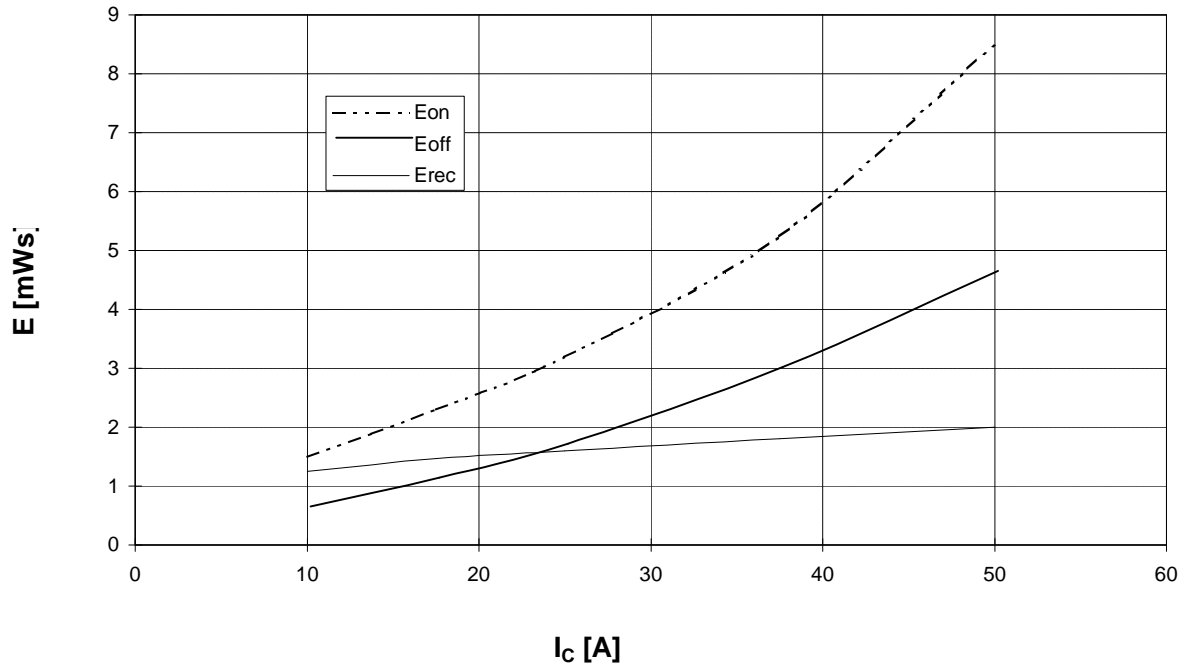

Schaltverluste Wechselr. (typisch) $E_{on} = f(R_G), E_{off} = f(R_G), E_{rec} = f(R_G)$
Switching losses Inverter (typical) $T_j = 125^\circ\text{C}, V_{GE} = +15\text{ V}, I_c = I_{nenn}, V_{CC} = 600\text{ V}$

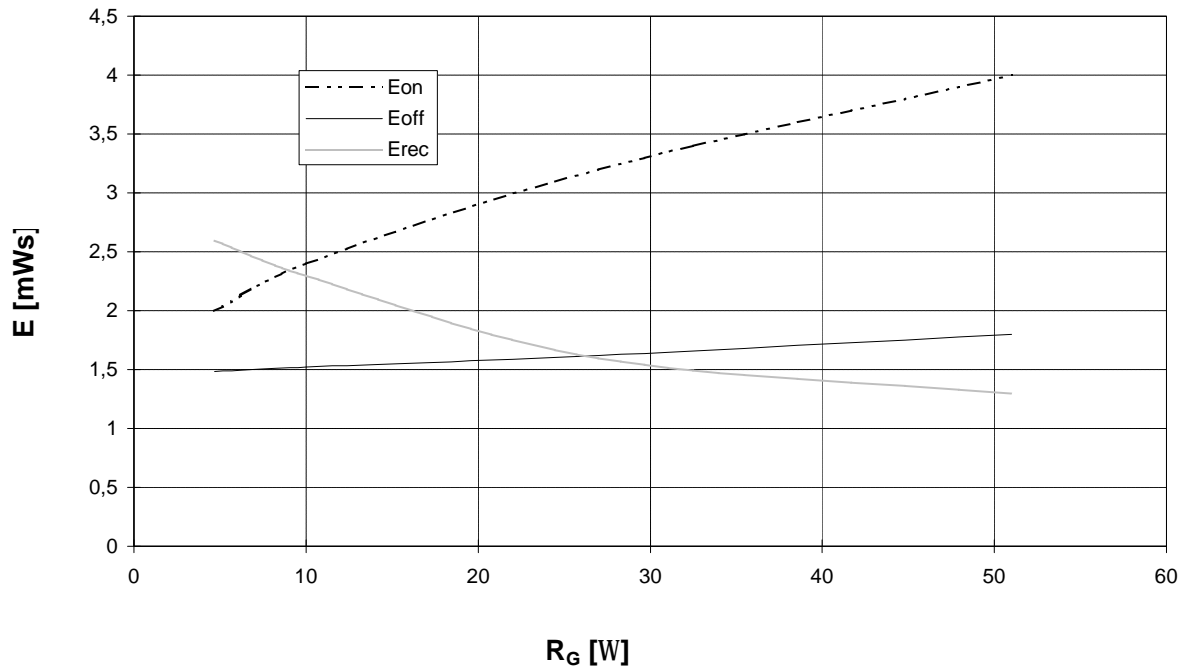



Transienter Wärmewiderstand Wechselr. $Z_{thJC} = f(t)$
Transient thermal impedance Inverter

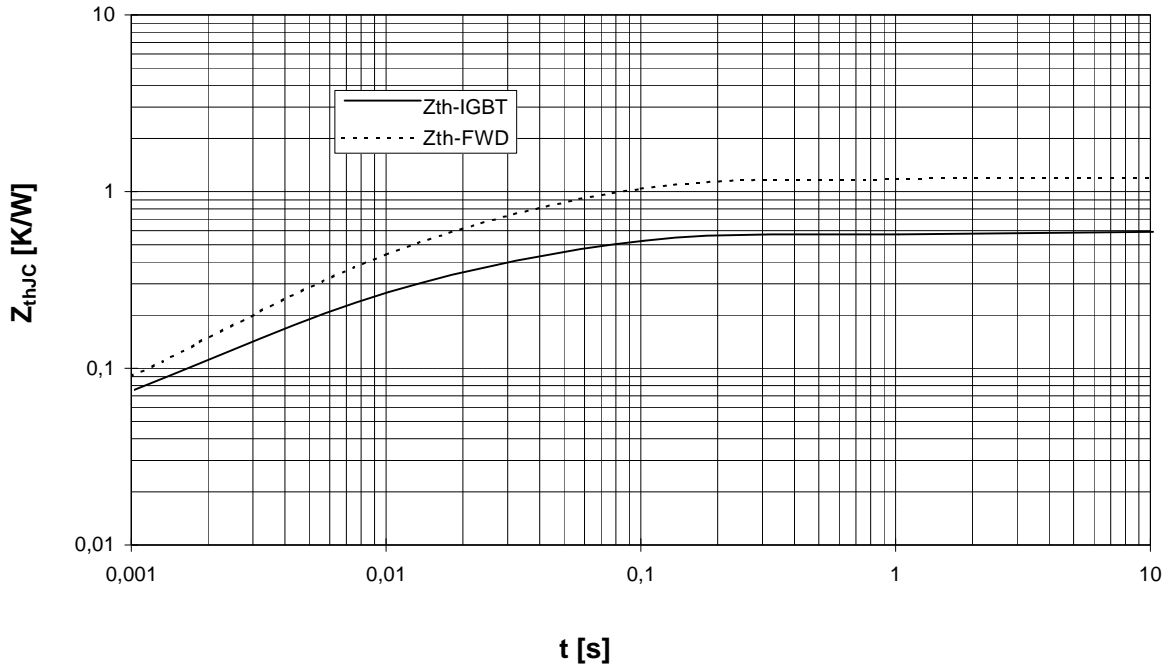

Sicherer Arbeitsbereich Wechselr. (RBSOA) $I_C = f(V_{CE})$
Reverse bias safe operating area Inverter (RBSOA) $T_{vi} = 125^\circ\text{C}$, $V_{GE} = \pm 15\text{V}$, $R_G = 27\ \text{Ohm}$

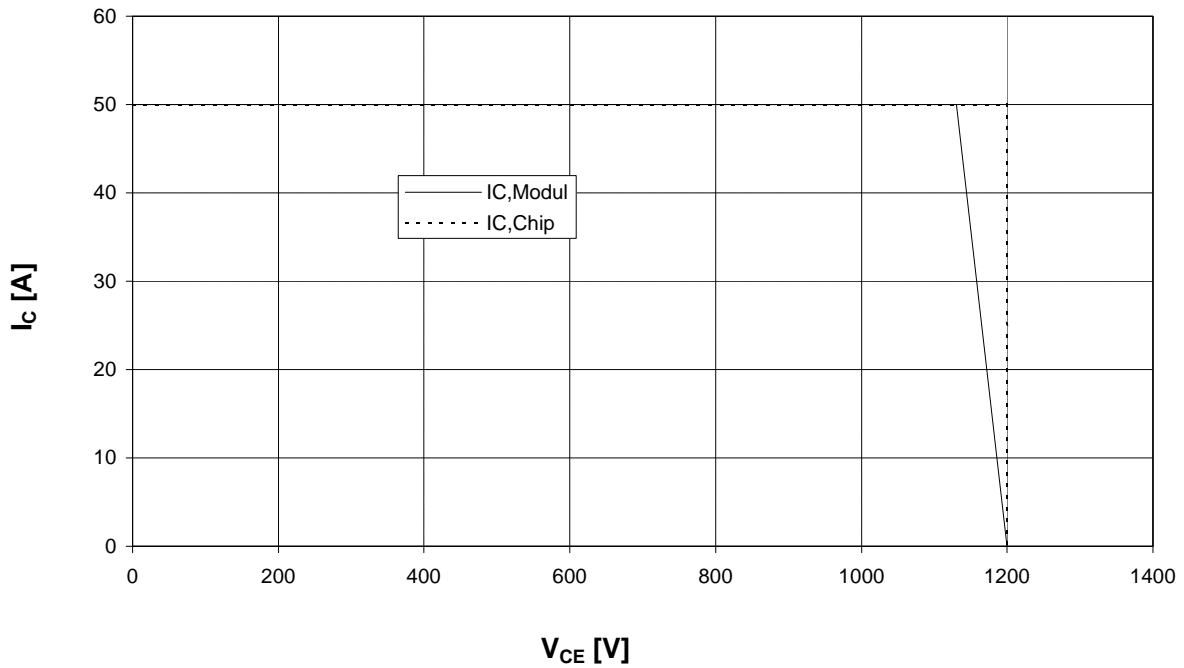

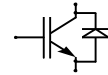

Ausgangskennlinienfeld Brems-Chopper-IGBT (typisch)

Output characteristic brake-chopper-IGBT (typical)

$I_C = f(V_{CE})$

$V_{GE} = 15\text{ V}$

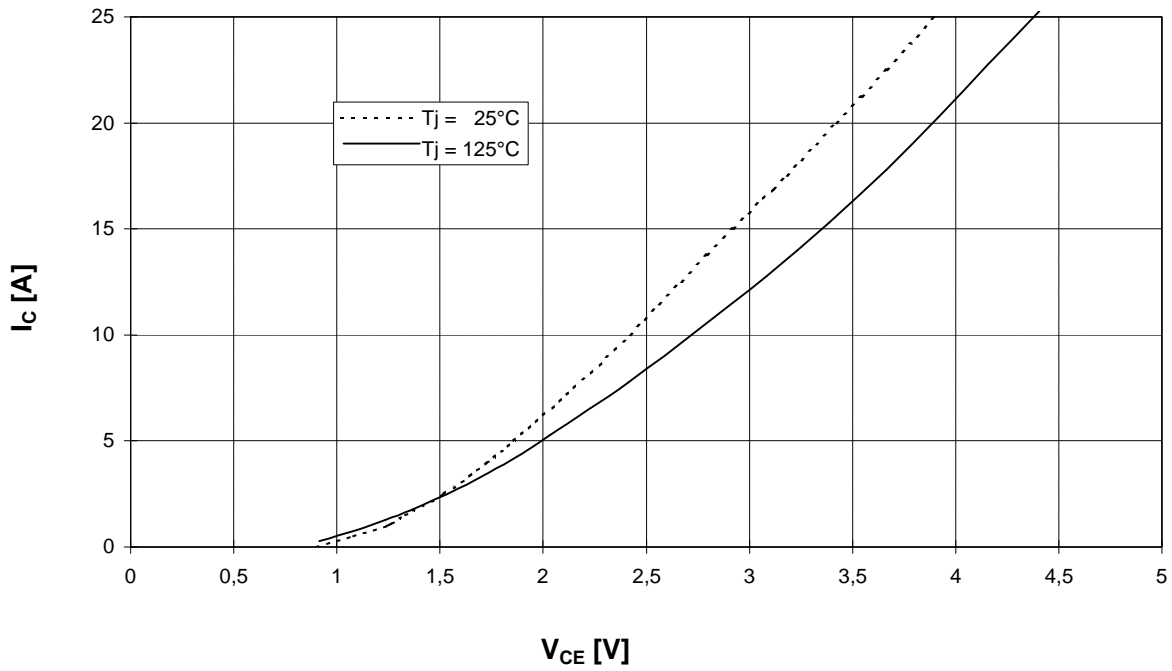

Durchlaßkennlinie der Brems-Chopper-Diode (typisch)

Forward characteristic of brake-chopper-FWD (typical)

$I_F = f(V_F)$

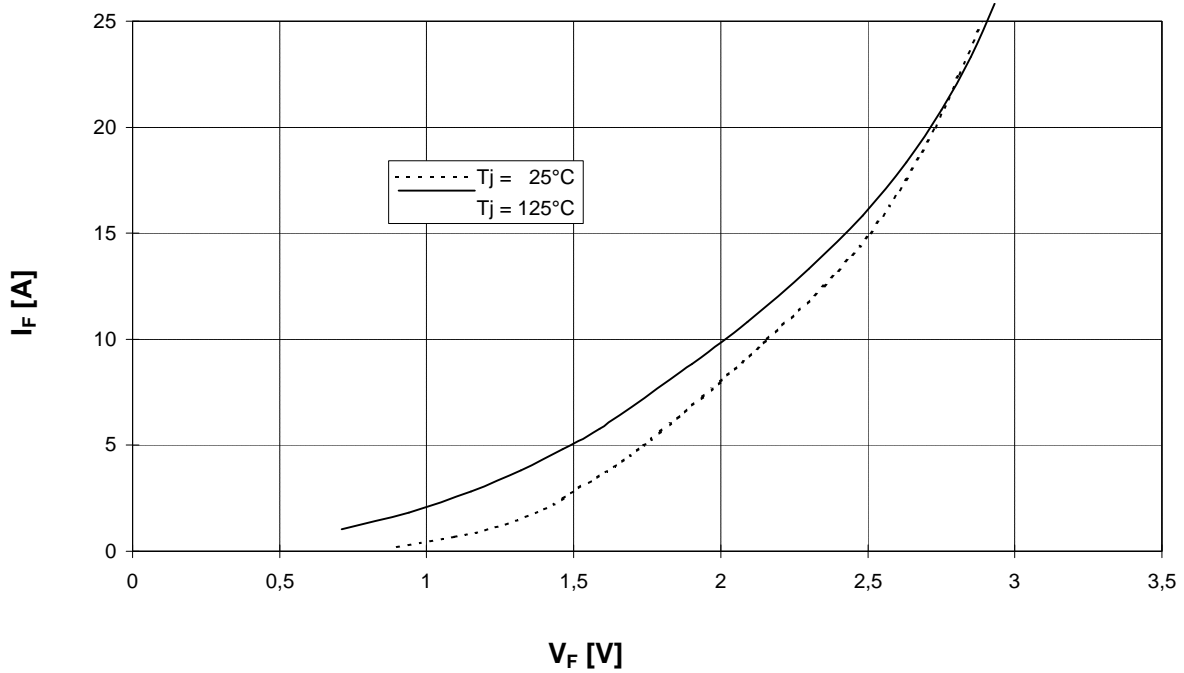



Durchlaßkennlinie der Gleichrichterdiode (typisch) $I_F = f(V_F)$
Forward characteristic of Rectifier Diode (typical)

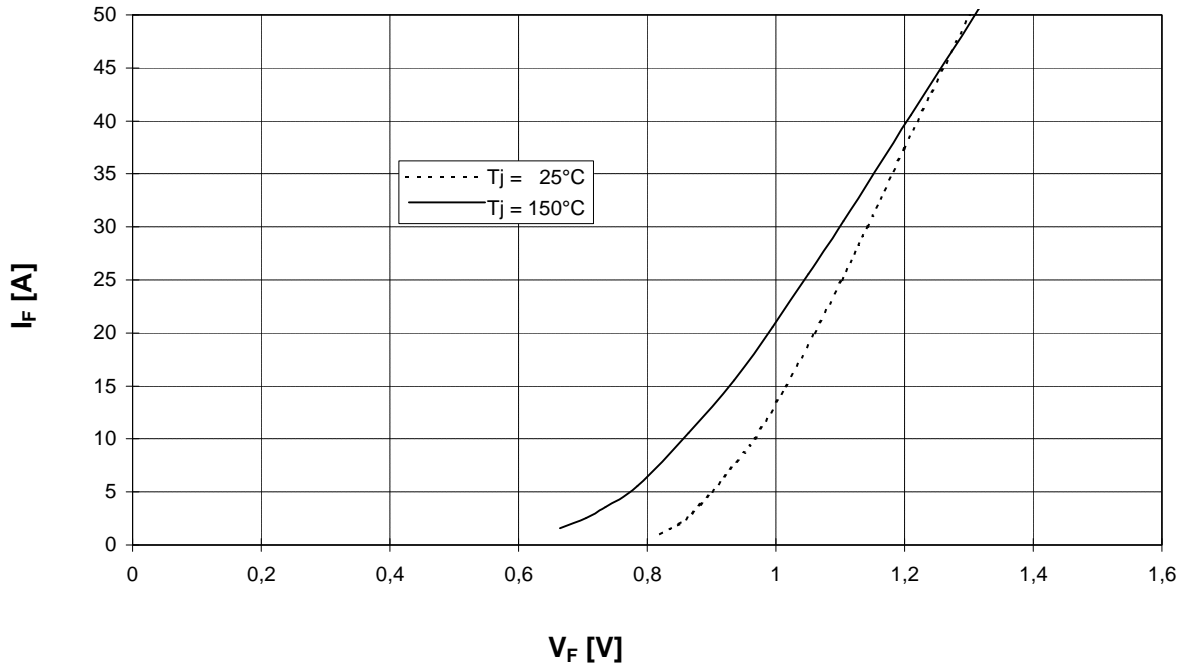

NTC- Temperaturkennlinie (typisch) $R = f(T)$
NTC- temperature characteristic (typical)



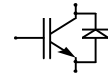

Schaltplan/ Circuit diagram

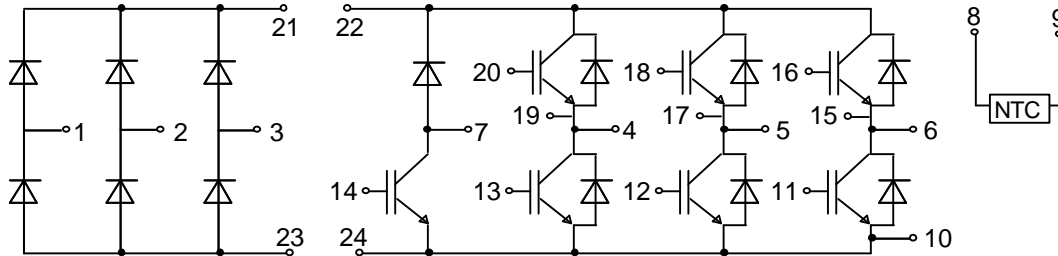

Gehäuseabmessungen/ Package outlines

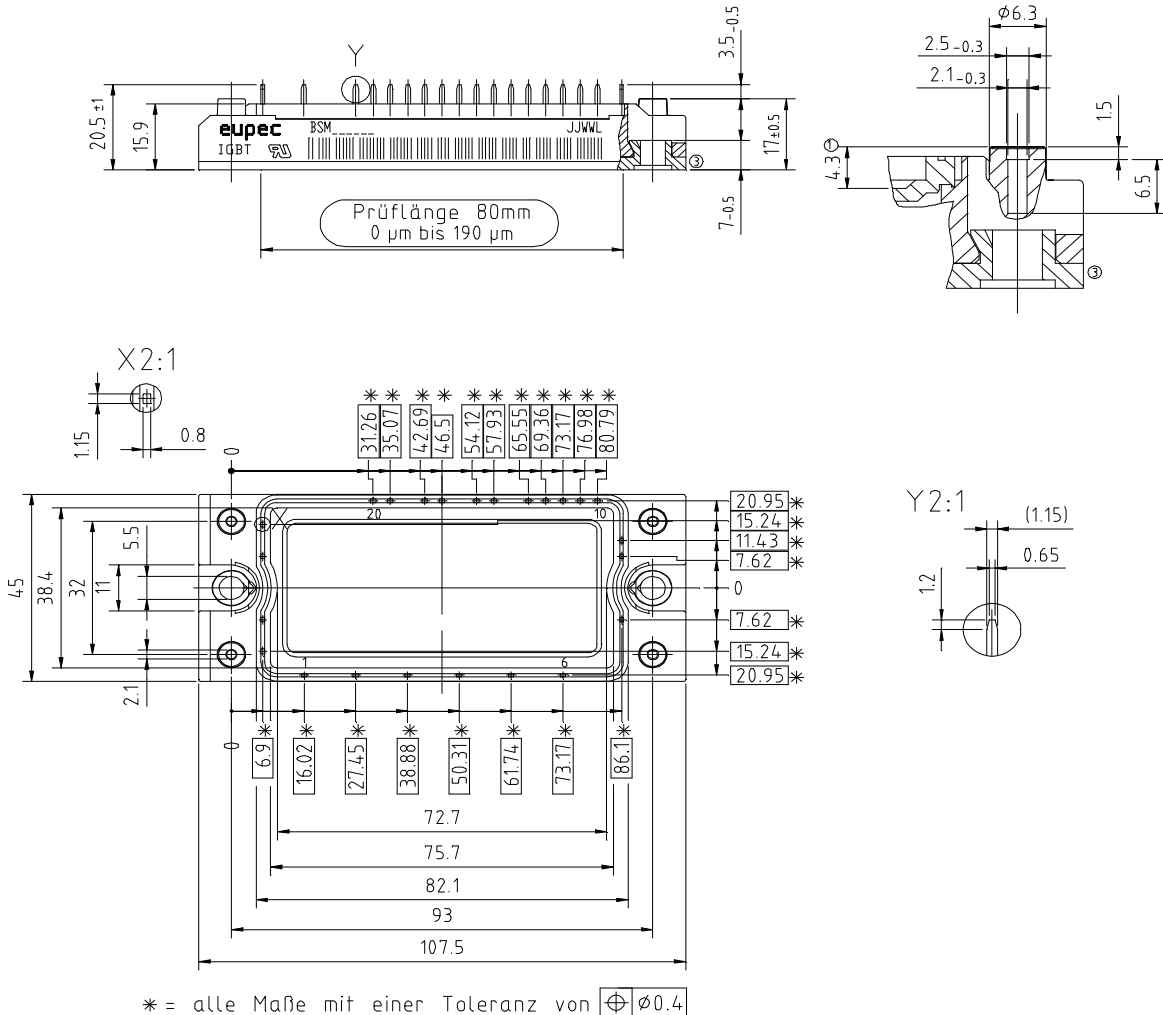

Mit dieser technischen Information werden Halbleiterbauelemente spezifiziert, jedoch keine Eigenschaften zugesichert. Sie gilt in Verbindung mit den zugehörigen Technischen Erläuterungen.

This technical information specifies semiconductor devices but promises no characteristics. It is valid in combination with the belonging technical notes.

Nutzungsbedingungen

Die in diesem Produktdatenblatt enthaltenen Daten sind ausschließlich für technisch geschultes Fachpersonal bestimmt. Die Beurteilung der Geeignetheit dieses Produktes für die von Ihnen anvisierte Anwendung sowie die Beurteilung der Vollständigkeit der bereitgestellten Produktdaten für diese Anwendung obliegt Ihnen bzw. Ihren technischen Abteilungen.

In diesem Produktdatenblatt werden diejenigen Merkmale beschrieben, für die wir eine liefervertragliche Gewährleistung übernehmen. Eine solche Gewährleistung richtet sich ausschließlich nach Maßgabe der im jeweiligen Liefervertrag enthaltenen Bestimmungen. Garantien jeglicher Art werden für das Produkt und dessen Eigenschaften keinesfalls übernommen.

Sollten Sie von uns Produktinformationen benötigen, die über den Inhalt dieses Produktdatenblatts hinausgehen und insbesondere eine spezifische Verwendung und den Einsatz dieses Produktes betreffen, setzen Sie sich bitte mit dem für Sie zuständigen Vertriebsbüro in Verbindung (siehe www.eupec.com, Vertrieb&Kontakt). Für Interessenten halten wir Application Notes bereit.

Aufgrund der technischen Anforderungen könnte unser Produkt gesundheitsgefährdende Substanzen enthalten. Bei Rückfragen zu den in diesem Produkt jeweils enthaltenen Substanzen setzen Sie sich bitte ebenfalls mit dem für Sie zuständigen Vertriebsbüro in Verbindung.

Sollten Sie beabsichtigen, das Produkt in Anwendungen der Luftfahrt, in gesundheits- oder lebensgefährdenden oder lebenserhaltenden Anwendungsbereichen einzusetzen, bitten wir um Mitteilung. Wir weisen darauf hin, dass wir für diese Fälle

- die gemeinsame Durchführung eines Risiko- und Qualitätsassessments;
- den Abschluss von speziellen Qualitätssicherungsvereinbarungen;
- die gemeinsame Einführung von Maßnahmen zu einer laufenden Produktbeobachtung dringend empfehlen und gegebenenfalls die Belieferung von der Umsetzung solcher Maßnahmen abhängig machen.

Soweit erforderlich, bitten wir Sie, entsprechende Hinweise an Ihre Kunden zu geben.

Inhaltliche Änderungen dieses Produktdatenblatts bleiben vorbehalten.

Terms & Conditions of usage

The data contained in this product data sheet is exclusively intended for technically trained staff. You and your technical departments will have to evaluate the suitability of the product for the intended application and the completeness of the product data with respect to such application.

This product data sheet is describing the characteristics of this product for which a warranty is granted. Any such warranty is granted exclusively pursuant the terms and conditions of the supply agreement. There will be no guarantee of any kind for the product and its characteristics.

Should you require product information in excess of the data given in this product data sheet or which concerns the specific application of our product, please contact the sales office, which is responsible for you (see www.eupec.com, sales&contact). For those that are specifically interested we may provide application notes.

Due to technical requirements our product may contain dangerous substances. For information on the types in question please contact the sales office, which is responsible for you.

Should you intend to use the Product in aviation applications, in health or life endangering or life support applications, please notify.

Please note, that for any such applications we urgently recommend

- to perform joint Risk and Quality Assessments;
- the conclusion of Quality Agreements;
- to establish joint measures of an ongoing product survey, and that we may make delivery depended on the realization of any such measures.

If and to the extent necessary, please forward equivalent notices to your customers.

Changes of this product data sheet are reserved.

单击下面可查看定价，库存，交付和生命周期等信息

[>>Infineon Technologies\(英飞凌\)](#)