

V_{DS}	30	V
$R_{DS(on) max}$ (@ $V_{GS} = 10V$)	4.2	mΩ
Q_g (typical)	15	nC
R_G (typical)	0.6	Ω
I_D (@ $T_{c(Bottom)} = 25^\circ C$)	82	A

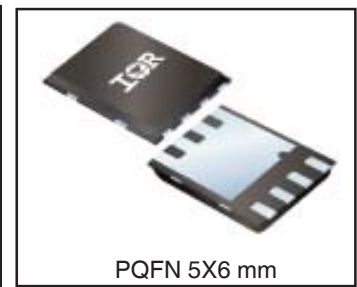
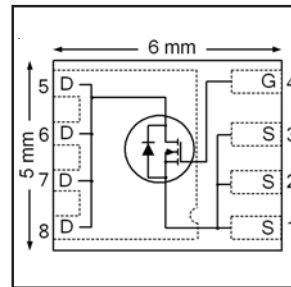

Applications

- Control MOSFET for high frequency buck converters

Features and Benefits

Features

Low charge (typical 15nC)
Low R_g (typical 0.6 Ω)
Low Thermal Resistance to PCB (<2.7 $^\circ C/W$)
100% R_g tested
Low Profile (<0.9 mm)
Industry-Standard Pinout
Compatible with Existing Surface Mount Techniques
RoHS Compliant Containing no Lead, no Bromide and no Halogen
MSL1, Industrial Qualification

Benefits

results in
⇒

Lower Switching Losses
Lower Switching Losses
Increased Power Density
Increased Reliability
Increased Power Density
Multi-Vendor Compatibility
Easier Manufacturing
Environmentally Friendlier
Increased Reliability

Orderable part number	Package Type	Standard Pack		Note
		Form	Quantity	
IRFH5303TRPBF	PQFN 5mm x 6mm	Tape and Reel	4000	
IRFH5303TR2PBF	PQFN 5mm x 6mm	Tape and Reel	400	EOL notice # 259

Absolute Maximum Ratings

	Parameter	Max.	Units
V_{DS}	Drain-to-Source Voltage	30	V
V_{GS}	Gate-to-Source Voltage	± 20	
$I_D @ T_A = 25^\circ C$	Continuous Drain Current, $V_{GS} @ 10V$	23	A
$I_D @ T_A = 70^\circ C$	Continuous Drain Current, $V_{GS} @ 10V$	18	
$I_D @ T_{c(Bottom)} = 25^\circ C$	Continuous Drain Current, $V_{GS} @ 10V$	82	
$I_D @ T_{c(Bottom)} = 100^\circ C$	Continuous Drain Current, $V_{GS} @ 10V$	52	
I_{DM}	Pulsed Drain Current ①	330	
$P_D @ T_A = 25^\circ C$	Power Dissipation ⑤	3.6	W
$P_D @ T_{c(Bottom)} = 25^\circ C$	Power Dissipation ⑤	46	
	Linear Derating Factor ⑤	0.029	W/ $^\circ C$
T_J T_{STG}	Operating Junction and Storage Temperature Range	-55 to + 150	$^\circ C$

Notes ① through ⑤ are on page 9

Static @ T_J = 25°C (unless otherwise specified)

	Parameter	Min.	Typ.	Max.	Units	Conditions
BV _{DSS}	Drain-to-Source Breakdown Voltage	30	—	—	V	V _{GS} = 0V, I _D = 250μA
ΔBV _{DSS} /ΔT _J	Breakdown Voltage Temp. Coefficient	—	0.02	—	V/°C	Reference to 25°C, I _D = 1mA
R _{DS(on)}	Static Drain-to-Source On-Resistance	—	3.6	4.2	mΩ	V _{GS} = 10V, I _D = 49A ③
		—	5.7	6.8		V _{GS} = 4.5V, I _D = 49A ③
V _{GS(th)}	Gate Threshold Voltage	1.35	1.8	2.35	V	V _{DS} = V _{GS} , I _D = 50μA
ΔV _{GS(th)}	Gate Threshold Voltage Coefficient	—	-6.4	—	mV/°C	
I _{DSS}	Drain-to-Source Leakage Current	—	—	5.0	μA	V _{DS} = 24V, V _{GS} = 0V
		—	—	150		V _{DS} = 24V, V _{GS} = 0V, T _J = 125°C
I _{GSS}	Gate-to-Source Forward Leakage	—	—	100	nA	V _{GS} = 20V
	Gate-to-Source Reverse Leakage	—	—	-100		V _{GS} = -20V
g _{fs}	Forward Transconductance	110	—	—	S	V _{DS} = 15V, I _D = 49A
Q _g	Total Gate Charge	—	41	—	nC	V _{GS} = 10V, V _{DS} = 15V, I _D = 49A
Q _g	Total Gate Charge	—	15	23	nC	V _{DS} = 15V V _{GS} = 4.5V I _D = 49A See Fig.17 & 18
Q _{gs1}	Pre-V _{th} Gate-to-Source Charge	—	3.5	—		
Q _{gs2}	Post-V _{th} Gate-to-Source Charge	—	2.5	—		
Q _{gd}	Gate-to-Drain Charge	—	5.4	—		
Q _{godr}	Gate Charge Overdrive	—	3.6	—		
Q _{sw}	Switch Charge (Q _{gs2} + Q _{gd})	—	7.9	—		
Q _{oss}	Output Charge	—	10	—	nC	V _{DS} = 16V, V _{GS} = 0V
R _G	Gate Resistance	—	0.6	—	Ω	
t _{d(on)}	Turn-On Delay Time	—	11	—	ns	V _{DD} = 15V, V _{GS} = 4.5V I _D = 49A R _G = 1.8Ω See Fig.15
t _r	Rise Time	—	31	—		
t _{d(off)}	Turn-Off Delay Time	—	8.8	—		
t _f	Fall Time	—	6.1	—		
C _{iss}	Input Capacitance	—	2190	—	pF	V _{GS} = 0V V _{DS} = 15V f = 1.0MHz
C _{oss}	Output Capacitance	—	520	—		
C _{rss}	Reverse Transfer Capacitance	—	220	—		

Avalanche Characteristics

	Parameter	Typ.	Max.	Units
E _{AS}	Single Pulse Avalanche Energy ②	—	46	mJ
I _{AR}	Avalanche Current ①	—	49	A

Diode Characteristics

	Parameter	Min.	Typ.	Max.	Units	Conditions
I _S	Continuous Source Current (Body Diode)	—	—	82	A	MOSFET symbol showing the integral reverse p-n junction diode.
I _{SM}	Pulsed Source Current (Body Diode) ①	—	—	330		
V _{SD}	Diode Forward Voltage	—	—	1.0	V	T _J = 25°C, I _S = 49A, V _{GS} = 0V ③
t _{rr}	Reverse Recovery Time	—	19	29	ns	T _J = 25°C, I _F = 49A, V _{DD} = 15V
Q _{rr}	Reverse Recovery Charge	—	39	59	nC	di/dt = 350A/μs ③
t _{on}	Forward Turn-On Time	Time is dominated by parasitic Inductance				

Thermal Resistance

	Parameter	Typ.	Max.	Units
R _{θJC} (Bottom)	Junction-to-Case ④	—	2.7	°C/W
R _{θJC} (Top)	Junction-to-Case ④	—	15	
R _{θJA}	Junction-to-Ambient ⑤	—	35	
R _{θJA} (<10s)	Junction-to-Ambient ⑤	—	22	

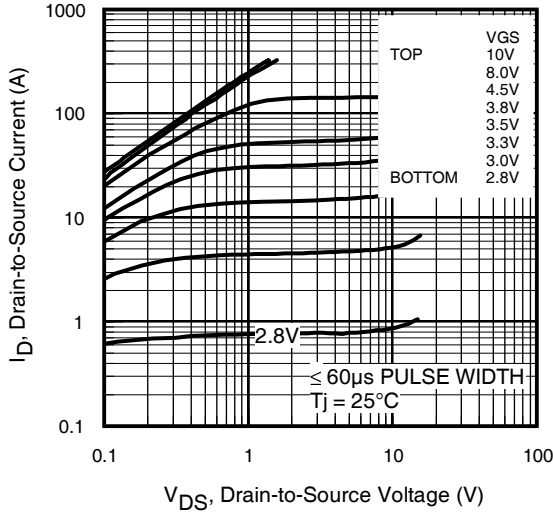
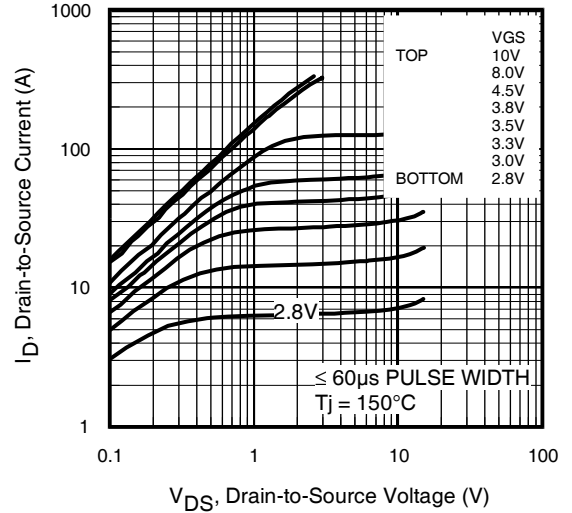
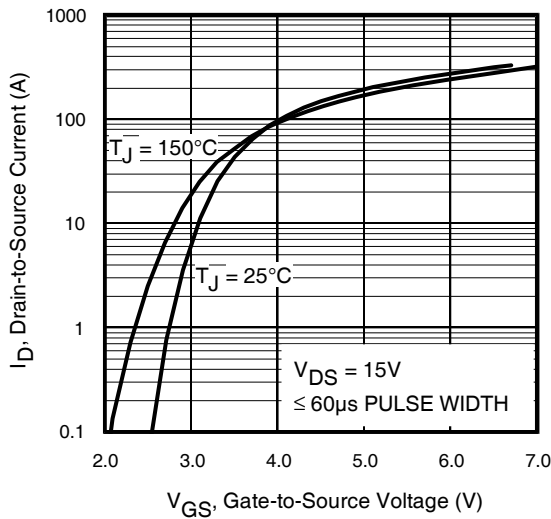
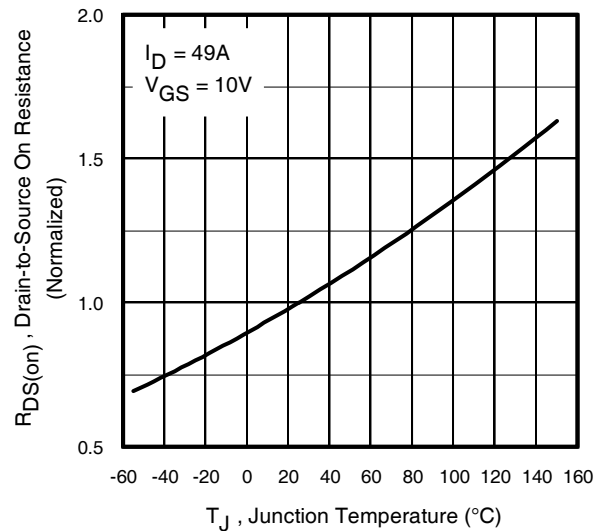
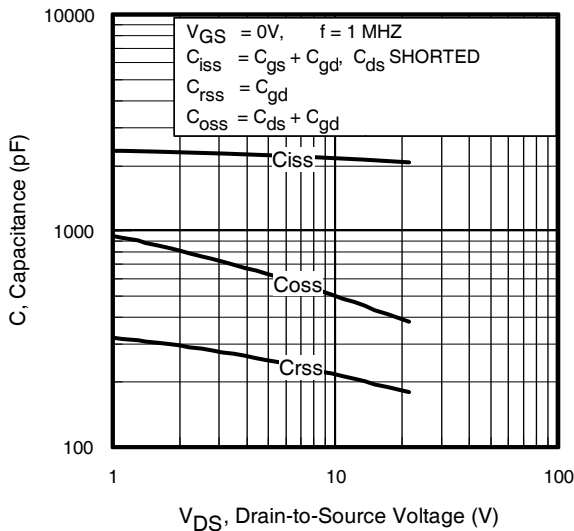
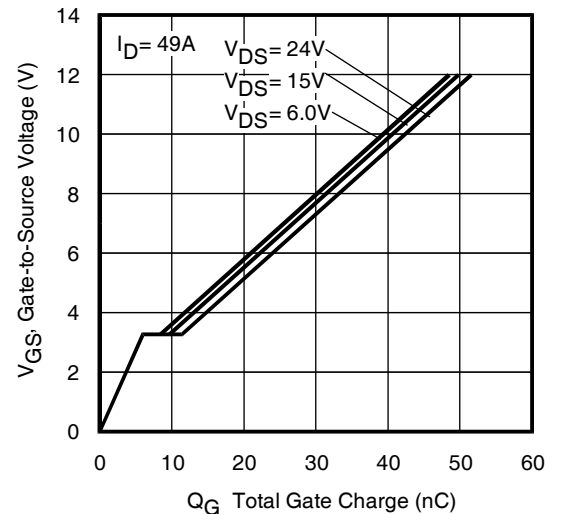
Fig 1. Typical Output Characteristics

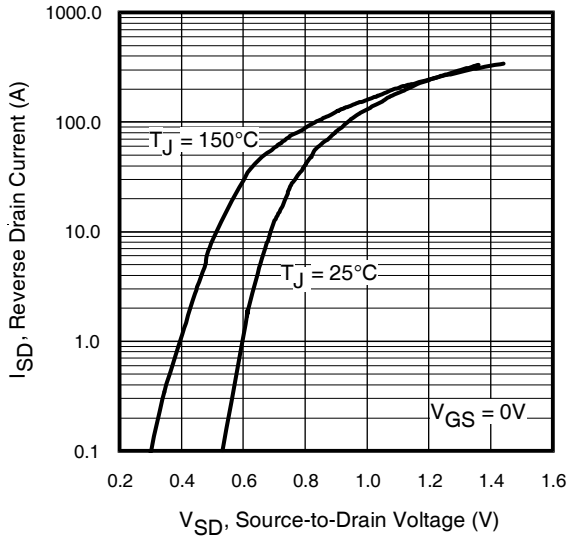
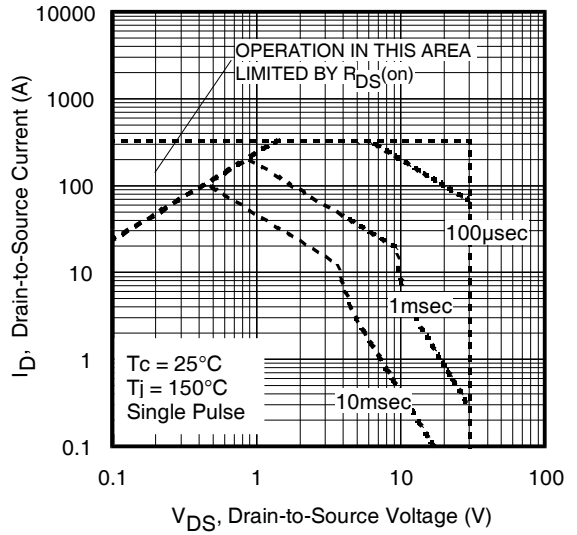
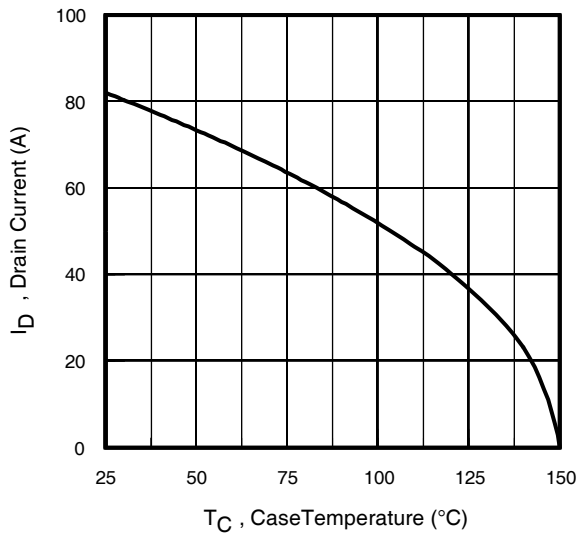
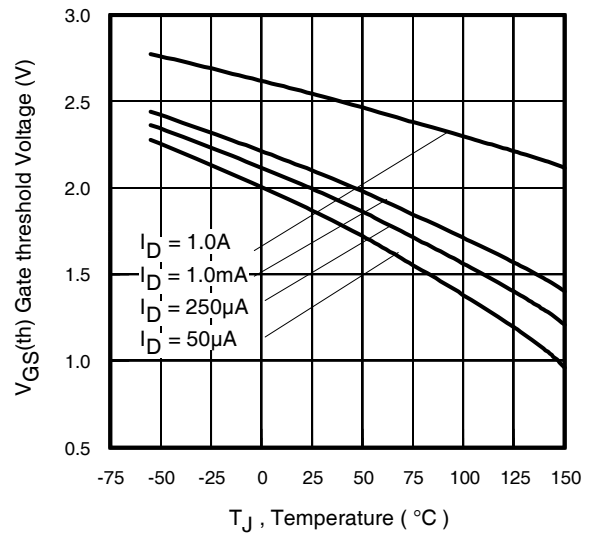
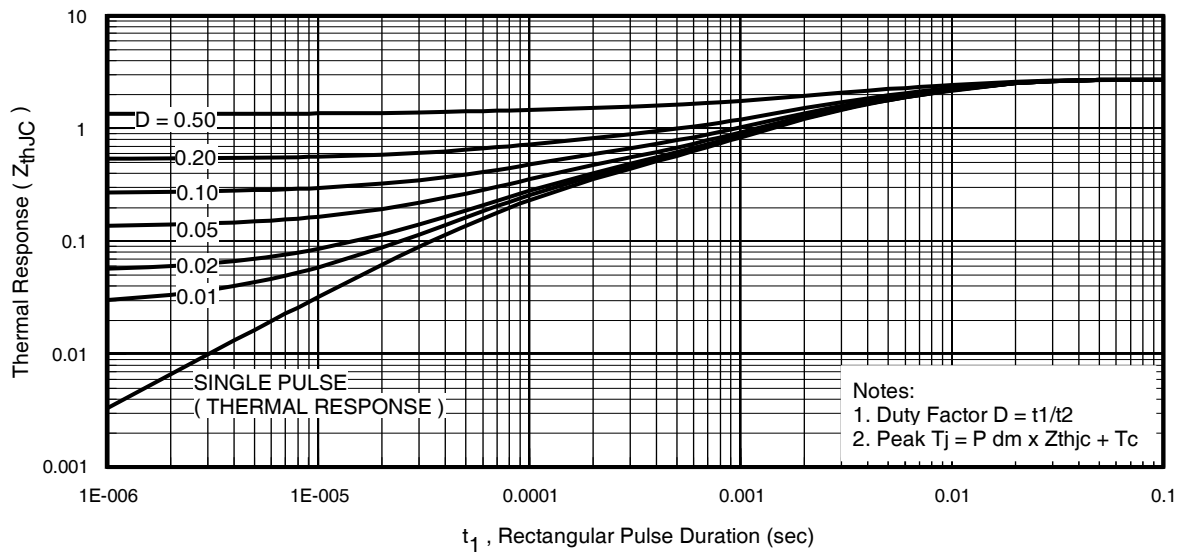
Fig 2. Typical Output Characteristics

Fig 3. Typical Transfer Characteristics

Fig 4. Normalized On-Resistance Vs. Temperature

Fig 5. Typical Capacitance Vs. Drain-to-Source Voltage

Fig 6. Typical Gate Charge Vs. Gate-to-Source Voltage

Fig 7. Typical Source-Drain Diode Forward Voltage

Fig 8. Maximum Safe Operating Area

Fig 9. Maximum Drain Current Vs. Case (Bottom) Temperature

Fig 10. Threshold Voltage Vs. Temperature

Fig 11. Maximum Effective Transient Thermal Impedance, Junction-to-Case (Bottom)

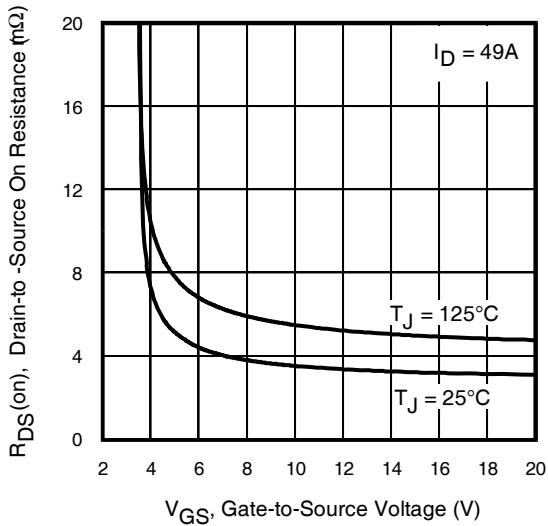
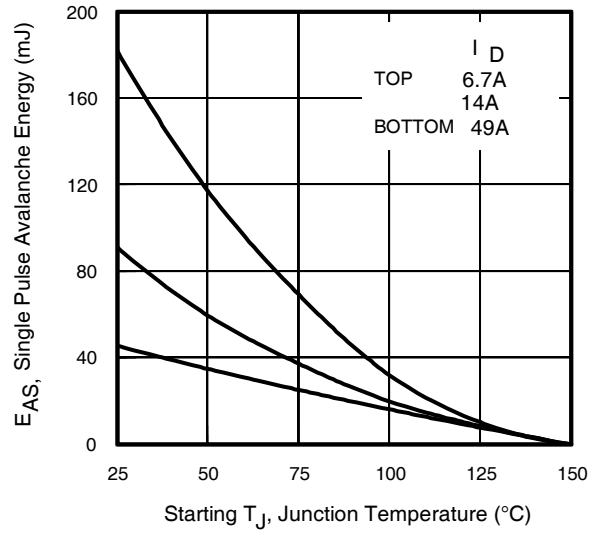

Fig 12. On-Resistance vs. Gate Voltage

Fig 13. Maximum Avalanche Energy vs. Drain Current

Fig 14a. Unclamped Inductive Test Circuit

Fig 14b. Unclamped Inductive Waveforms

Fig 15a. Switching Time Test Circuit

Fig 15b. Switching Time Waveforms

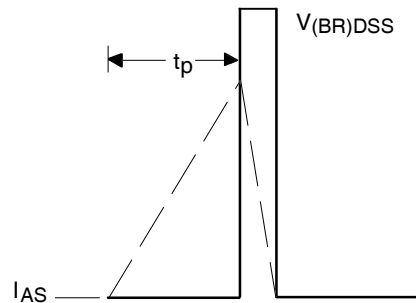
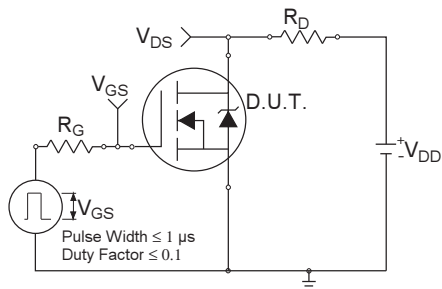
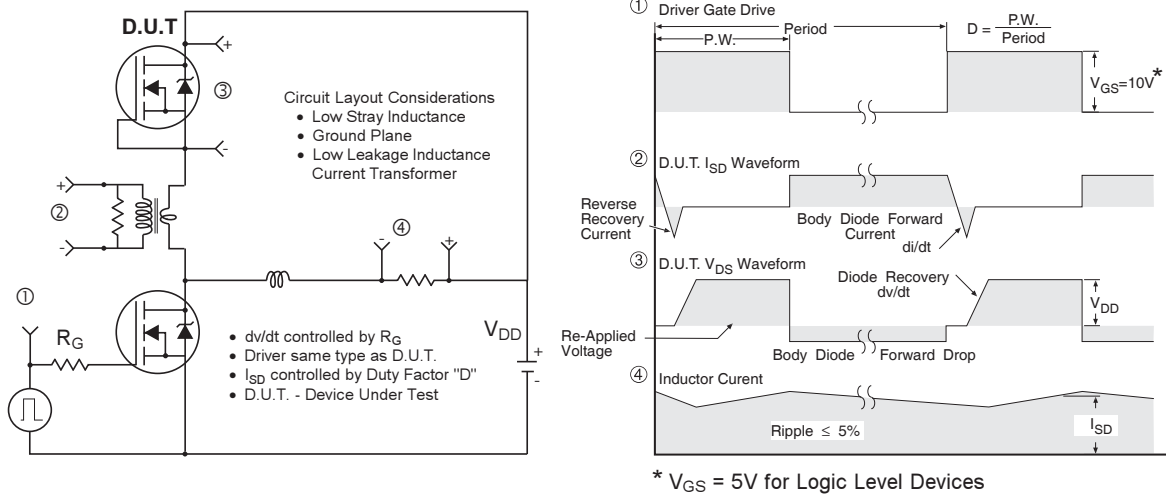

Fig 16. Peak Diode Recovery dv/dt Test Circuit for N-Channel HEXFET® Power MOSFETs

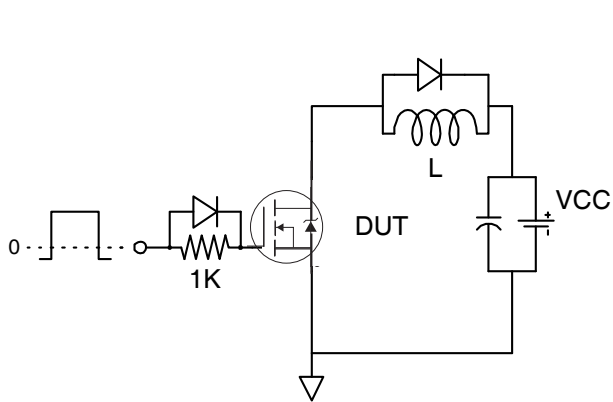
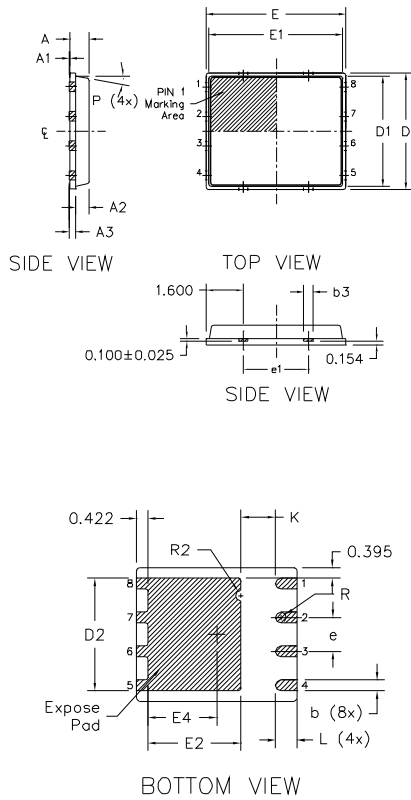

Fig 17. Gate Charge Test Circuit



Fig 18. Gate Charge Waveform

PQFN 5x6 Outline "B" Package Details



DIM SYMBOL	MILLIMETERS		INCH	
	MIN	MAX	MIN	MAX
A	0.800	0.900	0.0315	0.0543
A1	0.000	0.050	0.0000	0.0020
A3	0.200 REF		0.0079 REF	
b	0.350	0.470	0.0138	0.0185
b1	0.025	0.125	0.0010	0.0049
b2	0.210	0.410	0.0083	0.0161
b3	0.150	0.450	0.0059	0.0177
D	5.000 BSC		0.1969 BSC	
D1	4.750 BSC		0.1870 BSC	
D2	4.100	4.300	0.1614	0.1693
E	6.000 BSC		0.2362 BSC	
E1	5.750 BSC		0.2264 BSC	
E2	3.380	3.780	0.1331	0.1488
e	1.270 REF		0.0500 REF	
e1	2.800 REF		0.1102 REF	
K	1.200	1.420	0.0472	0.0559
L	0.710	0.900	0.0280	0.0354
P	0°	12°	0°	12°
R	0.200 REF		0.0079 REF	
R2	0.150	0.200	0.0059	0.0079

- Note:**
1. Dimensions and tolerancing confirm to ASME Y14.5M-1994
 2. Dimension L represents terminal full back from package edge up to 0.1mm is acceptable
 3. Coplanarity applies to the expose Heat Slug as well as the terminal
 4. Radius on terminal is Optional

For more information on board mounting, including footprint and stencil recommendation, please refer to application note AN-1136: <http://www.irf.com/technical-info/appnotes/an-1136.pdf>
 For more information on package inspection techniques, please refer to application note AN-1154: <http://www.irf.com/technical-info/appnotes/an-1154.pdf>

PQFN 5x6 Part Marking

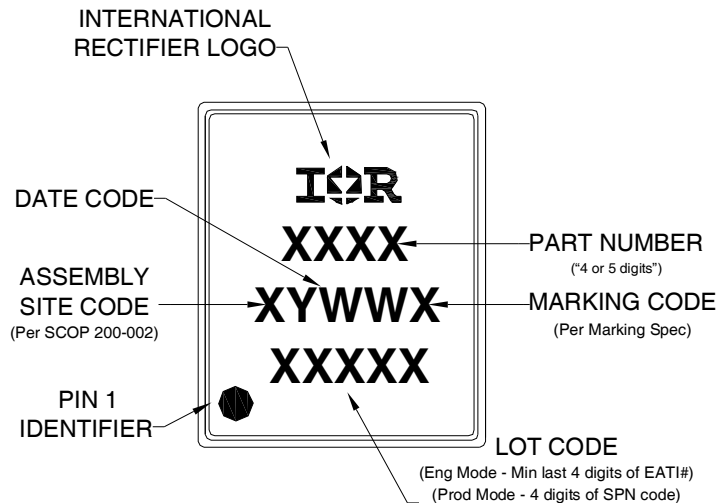

Note: For the most current drawing please refer to IR website at: <http://www.irf.com/package/>

PQFN Tape and Reel

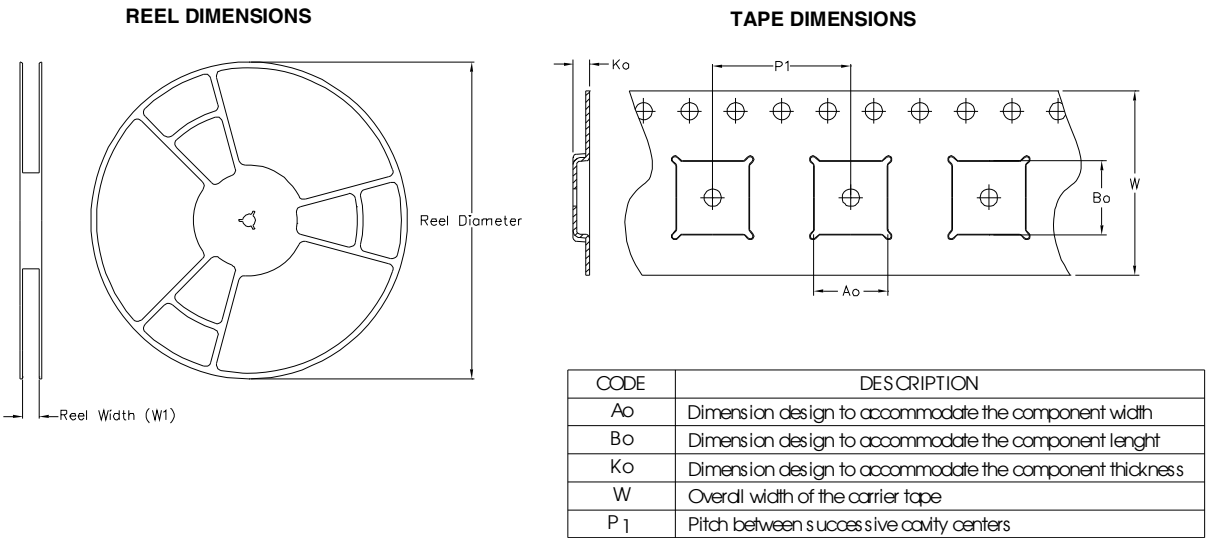

QUADRANT ASSIGNMENTS FOR PIN 1 ORIENTATION IN TAPE

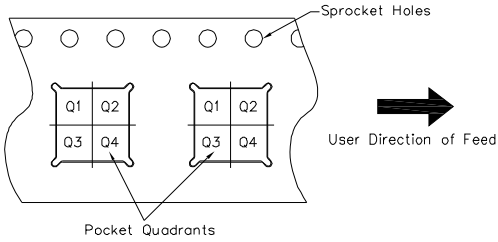

Note: All dimension are nominal

Package Type	Reel Diameter (Inch)	QTY	Reel Width W1 (mm)	Ao (mm)	Bo (mm)	Ko (mm)	P1 (mm)	W (mm)	Pin 1 Quadrant
5 X 6 PQFN	13	4000	12.4	6.300	5.300	1.20	8.00	12	Q1

Note: For the most current drawing please refer to IR website at: <http://www.irf.com/package/>

Qualification information[†]

Qualification level	Industrial ^{††} (per JEDEC JESD47F ^{†††} guidelines)	
Moisture Sensitivity Level	PQFN 5mm x 6mm	MSL1 (per JEDEC J-STD-020D ^{†††})
RoHS compliant	Yes	

† Qualification standards can be found at International Rectifier’s web site
<http://www.irf.com/product-info/reliability>

†† Higher qualification ratings may be available should the user have such requirements.
 Please contact your International Rectifier sales representative for further information:
<http://www.irf.com/whoto-call/salesrep/>

††† Applicable version of JEDEC standard at the time of product release.

Notes:

- ① Repetitive rating; pulse width limited by max. junction temperature.
- ② Starting $T_J = 25^\circ\text{C}$, $L = 0.038\text{mH}$, $R_G = 25\Omega$, $I_{AS} = 49\text{A}$.
- ③ Pulse width $\leq 400\mu\text{s}$; duty cycle $\leq 2\%$.
- ④ R_θ is measured at T_J of approximately 90°C .
- ⑤ When mounted on 1 inch square 2 oz copper pad on 1.5x1.5 in. board of FR-4 material.

Revision History

Date	Comment
5/13/2014	<ul style="list-style-type: none"> • Updated ordering information to reflect the End-Of-life (EOL) of the mini-reel option (EOL notice #259) • Updated package outline on page 7. • Updated data sheet based on corporate template.
3/19/2015	<ul style="list-style-type: none"> • Updated package outline and tape and reel on pages 7 and 8.

单击下面可查看定价，库存，交付和生命周期等信息

[>>Infineon Technologies\(英飞凌\)](#)