

# IFX78M05

Three Terminal 500mA Positive Voltage Regulator

## Datasheet

Rev. 1.0, 2013-07-15

# Standard Power



## 1 Overview

### Features

- 500 mA Output Current Capability
- High Input Voltage Range: up to 35 Volts
- Available in Fixed 5V Output Voltage Version
- Wide temperature range  $T_j = -40\text{ °C to }+125\text{ °C}$
- Over temperature Protection
- Short Circuit Current Limit
- Safe-Area Protection
- Thermally Optimized Packages
- Green Product (RoHS compliant)



**PG-TO-252-3**

The IFX78M05 is not qualified and manufactured according to the requirements of Infineon Technologies with regards to automotive and/or transportation applications. For automotive applications please refer to the Infineon TLx (TLE, TLS, TLF....) voltage regulator products.

### Description

The IFX78M05 monolithic 3-terminal positive voltage regulator employs internal current-limiting, thermal shutdown and safe-area compensation, making it extremely robust. The IFX78M05 is available in a fixed 5V version and is capable of delivering an output current of 0.5 A. This regulator can provide local on-card regulation, eliminating the distribution problems associated with single point regulation. This linear voltage regulator is designed for a wide variety of applications and suitable for use in harsh environments. The short-circuit current limit, limits the output current of the device. The safe-area protection feature limits the internal power dissipation, in case the internal power dissipation becomes too high, the thermal shutdown implemented prevents the device from overheating.

The 5V voltage regulator is available in the TO-252 package.

Type	Package	Marking
IFX78M05	PG-TO-252-3	78M05BF

## 2 Block Diagram

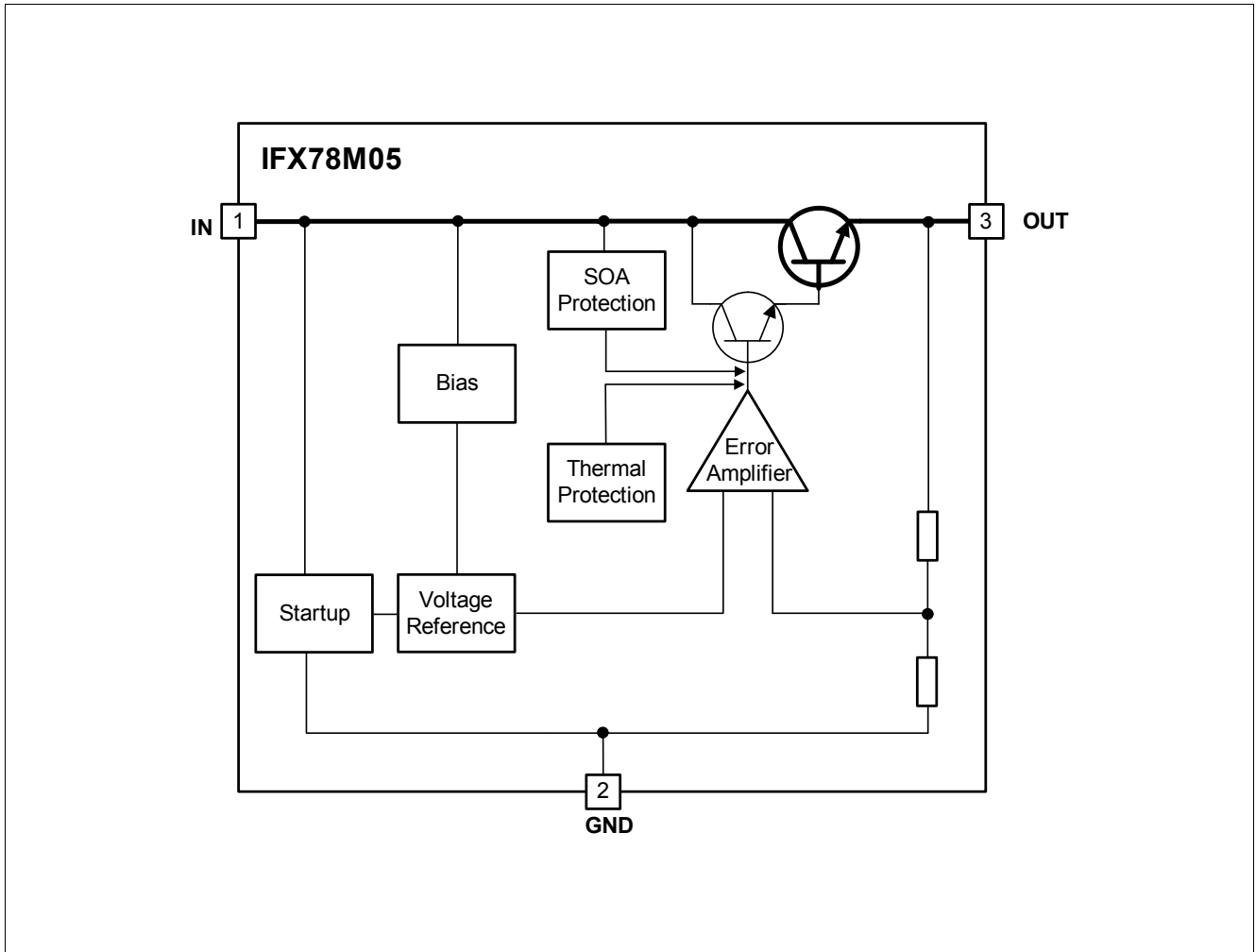

Figure 1 Block Diagram

### 3 Pin Configuration

#### 3.1 Pin Assignment

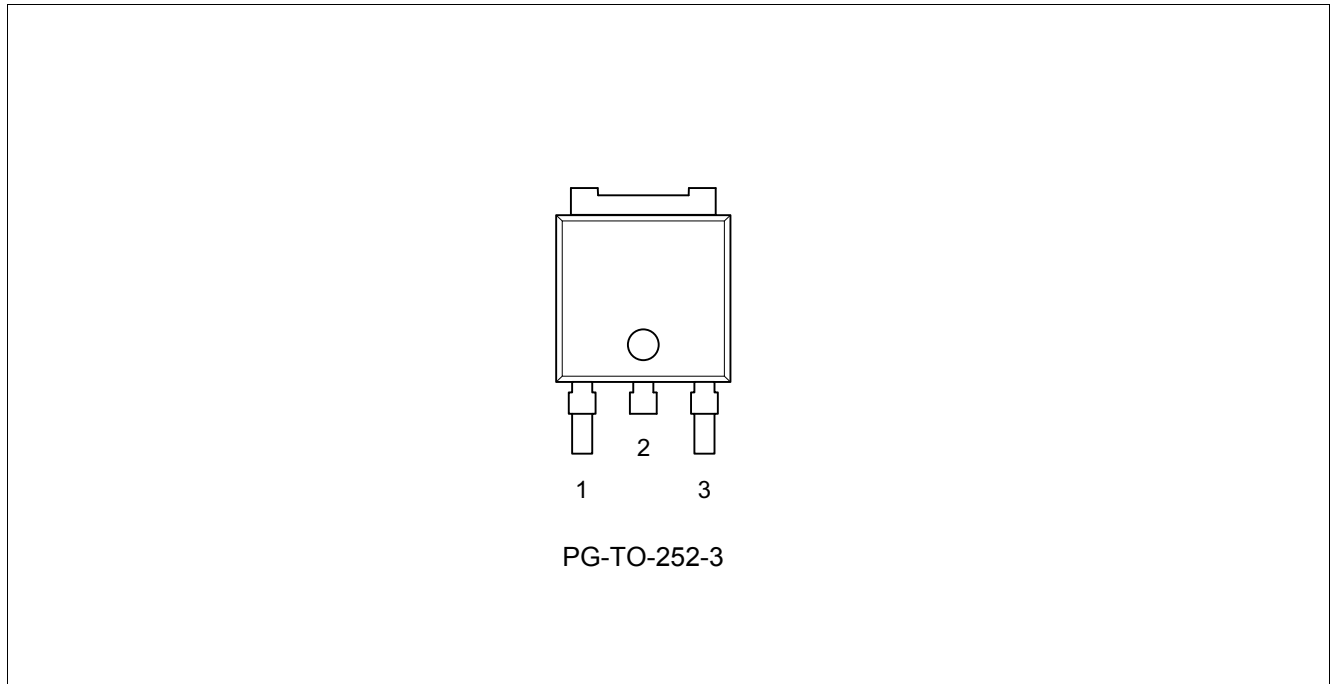

Figure 2 Pin Configuration

#### 3.2 Pin Definitions and Functions

Pin	Symbol	Function
1	IN	<b>Input</b> The input pin is where the input power is supplied to the device. A capacitor is required from input to ground. Please refer to the application information section for more details. <a href="#">“Application Information” on Page 12</a>
2	GND	<b>Ground</b> , Internally connected to thermal tab
3	OUT	<b>Output</b> The output voltage supplies power to the load. For stability a minimum output capacitor of 100nF is required from output to ground. Please refer to the application information section for more details. <a href="#">“Application Information” on Page 12</a>

## 4 General Product Characteristics

### 4.1 Absolute Maximum Ratings

**Table 1 Absolute Maximum Ratings** <sup>1)</sup>

$T_j = -40\text{ °C}$  to  $+125\text{ °C}$ ; all voltages with respect to ground, positive current flowing into pin (unless otherwise specified)

Pos.	Parameter	Symbol	Limit Values		Unit	Conditions
			Min.	Max.		
<b>Voltage Input</b>						
4.1.1	Voltage	$V_{IN}$	-0.3	35	V	–
<b>Output Current</b>						
4.1.2	Current	$I_{OUT}$	Internally Limited		A	–
<b>Temperatures</b>						
4.1.3	Junction Temperature	$T_j$	-40	150	°C	–
4.1.4	Storage Temperature	$T_{stg}$	-50	150	°C	–
<b>ESD Susceptibility</b>						
4.1.5	All Pins	$V_{ESD}$	-2	2	kV	HBM <sup>2)</sup>
4.1.6	All Pins	$V_{ESD}$	-1	1	kV	CDM <sup>3)</sup>

1) Not subject to production test, specified by design

2) ESD susceptibility, HBM according to ANSI/ESDA/JEDEC JS-001(1.5 kΩ, 100 pF)

3) ESD susceptibility, Charged Device Model “CDM” according to JEDEC JESD22-C101

*Note: Stresses above the ones listed here may cause permanent damage to the device. Exposure to absolute maximum rating conditions for extended periods may affect device reliability.*

*Note: Integrated protection functions are designed to prevent IC destruction under fault conditions described in the data sheet. Fault conditions are considered as “outside” normal operating range. Protection functions are not designed for continuous repetitive operation.*

### 4.2 Functional Range

**Table 2 Functional Range**

Pos.	Parameter	Symbol	Limit Values		Unit	Conditions
			Min.	Max.		
4.2.1	Input Voltage Range	$V_{IN}$	$V_{OUT} + V_{dr}$	35	V	<sup>1)</sup>
4.2.2	Junction temperature	$T_j$	-40	125	°C	–

1) Output current is limited internally and depends on the maximum voltage, see Electrical Characteristics for more details.

*Note: Within the functional or operating range, the IC operates as described in the circuit description. The electrical characteristics are specified within the conditions given in the Electrical Characteristics table.*

### 4.3 Thermal Resistance

Note: This thermal data was generated in accordance with JEDEC JESD51 standards. For more information, go to [www.jedec.org](http://www.jedec.org).

Pos.	Parameter	Symbol	Limit Values			Unit	Conditions
			Min.	Typ.	Max.		
<b>PG-TO-252-3</b>							
4.3.1	Junction to Case <sup>1)</sup>	$R_{thJC}$	–	4	–	K/W	–
4.3.2	Junction to Ambient	$R_{thJA}$	–	27	–	K/W	– <sup>2)</sup>
4.3.3			–	113	–	K/W	Footprint Only
4.3.4			–	52	–	K/W	300mm <sup>2</sup> heatsink area on PCB <sup>3)</sup>
4.3.5			–	42	–	K/W	600mm <sup>2</sup> heatsink area on PCB

1) Not subject to production test, specified by design.

2) Specified  $R_{thJA}$  value is according to JEDEC JESD51-5,-7 at natural convection on FR4 2s2p board. The product (chip and package) was simulated on a 76.2 x 114.3 x 1.5 mm<sup>3</sup> board with 2 inner copper layers (2 x 70µm Cu, 2 x 35 µm Cu).

3) Specified  $R_{thJA}$  value is according to JEDEC JESD51-3 at natural convection on FR4 1s0p board. The product (chip and package) was simulated on a 76.2 x 114.3 x 1.5 mm<sup>3</sup> board with 1 copper layer (1 x 70µm Cu)

## 5 Electrical Characteristics

### 5.1 IFX7805

**Table 3 Electrical Characteristics**
 $-40\text{ °C} < T_j < 125\text{ °C}$ ;  $V_{IN} = 10\text{V}$ ,  $C_{IN} = 0.33\mu\text{F}$ ,  $C_{OUT} = 100\text{nF}$ ; unless otherwise specified.

Pos.	Parameter	Symbol	Limit Values			Unit	Test Condition
			Min.	Typ.	Max.		
5.1.1	Output Voltage	$V_{OUT}$	4.81	5.00	5.19	V	$I_{OUT} = 500\text{ mA}$ , $T_j = 25\text{ °C}$
5.1.2			4.80	5.00	5.20	V	$5\text{ mA} \leq I_{OUT} \leq 500\text{ mA}$ , $7.5\text{ V} \leq V_{IN} \leq 20\text{ V}$ $P_D \leq 15\text{ W}$
5.1.3	Line Regulation	$\Delta V_{OUT,LINE}$			4	mV	$I_{OUT} = 500\text{ mA}$ $8\text{ V} \leq V_{IN} \leq 12\text{ V}$ , $T_j = 25\text{ °C}$
5.1.4				1	10	mV	$I_{OUT} = 500\text{ mA}$ , $7.5\text{ V} \leq V_{IN} \leq 20\text{ V}$ $T_j = 25\text{ °C}$
5.1.5				3	10	mV	$I_{OUT} = 500\text{ mA}$ $7.5\text{ V} \leq V_{IN} \leq 20\text{ V}$
5.1.6	Load Regulation	$\Delta V_{OUT,LOAD}$		10	15	mV	$5.0\text{ mA} \leq I_{OUT} \leq 500\text{ mA}$ , $T_j = 25\text{ °C}$
5.1.7						15	mV
5.1.8	Dropout Voltage	$V_{dr}$		2		V	$I_{OUT} = 500\text{ mA}$ , $T_j = 25\text{ °C}$
5.1.9	Quiescent Current	$I_q$		3.5	5.0	mA	$I_{OUT} = 500\text{ mA}$ , $T_j = 25\text{ °C}$
5.1.10					3.5	6.0	mA
5.1.11	Quiescent Current Change	$\Delta I_q$		1.0		mA	$5.0\text{ mA} \leq I_{OUT} \leq 500\text{ mA}$
5.1.12				0.5	0.8	mA	$I_{OUT} = 500\text{ mA}$ $7.5\text{ V} \leq V_{IN} \leq 20\text{ V}$ $T_j = 25\text{ °C}$
5.1.13				0.5	1.0	mA	$I_{OUT} = 250\text{ mA}$ $8\text{ V} \leq V_{IN} \leq 25\text{ V}$
5.1.14	Output Noise Voltage	$V_{Noise}$		40		$\mu\text{V}$	$10\text{ Hz} \leq f \leq 100\text{ kHz}$ , $T_j = 25\text{ °C}^{1)}$
5.1.15	Ripple Rejection	$PSRR$	68	75		dB	$f = 120\text{ Hz}$ , $I_{OUT} = 10\text{ mA}$ $T_j = 25\text{ °C}^{2)}$
5.1.16	Short Circuit Current	$I_{SC}$		0.8		A	$V_{IN} = 35\text{ V}$ , $T_j = 25\text{ °C}$
5.1.17	Peak Output Current	$I_{PK}$	0.7	2.4		A	$T_j = 25\text{ °C}$
5.1.18	Input Voltage Required to Maintain Line Regulation	$V_{IN,MIN}$	7.5			V	$T_j = 25\text{ °C}$

1) Not subject to production test

2) Not subject to production test

*Note: The listed characteristics are ensured over the operating range of the integrated circuit. Typical characteristics specified mean values expected over the production spread. If not otherwise specified, typical characteristics apply at  $T_A = 25\text{ °C}$  and the given supply voltage.*

### 5.1.1 Typical Performance Graphs

#### Typical Performance Characteristics

**Output Voltage  $V_{OUT}$  Vs Junction Temperature  $T_j$  ( $V_{IN} = 7.5V$ )**

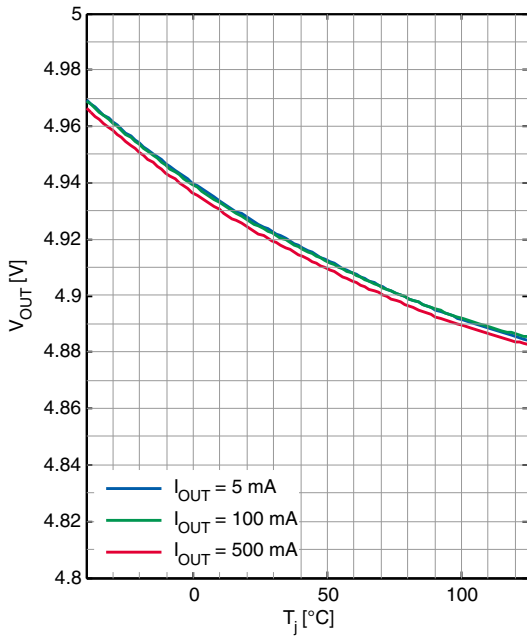

**Output Voltage  $V_{OUT}$  Vs Junction Temperature  $T_j$  ( $V_{IN} = 12V$ )**

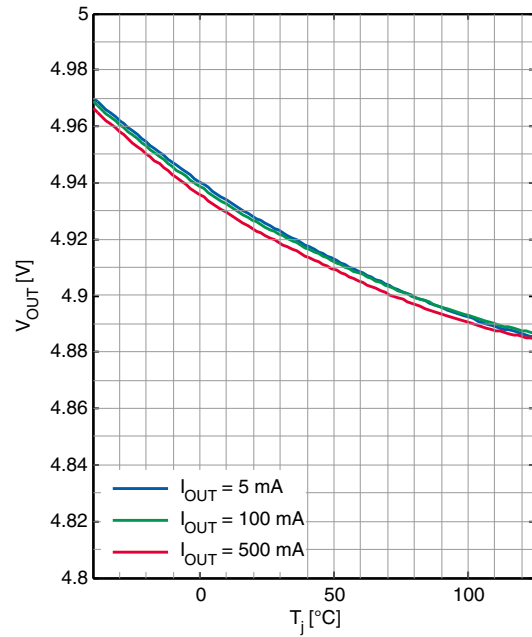

**Output Voltage  $V_{OUT}$  Vs Junction Temperature  $T_j$  ( $V_{IN} = 20V$ )**

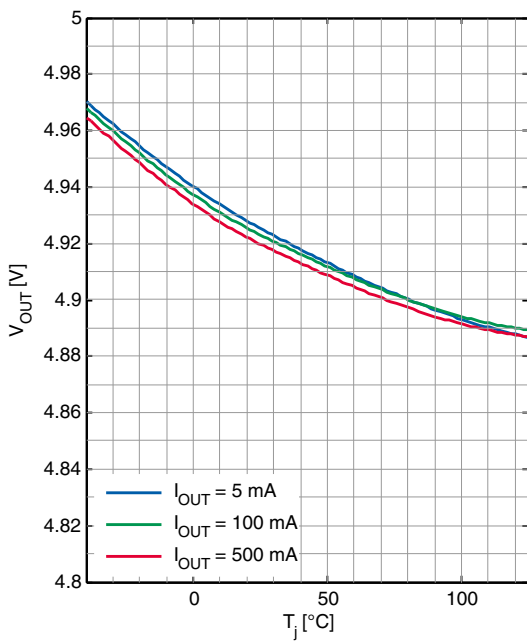

**Drop Voltage  $V_{DR}$  Vs Junction Temperature  $T_j$**

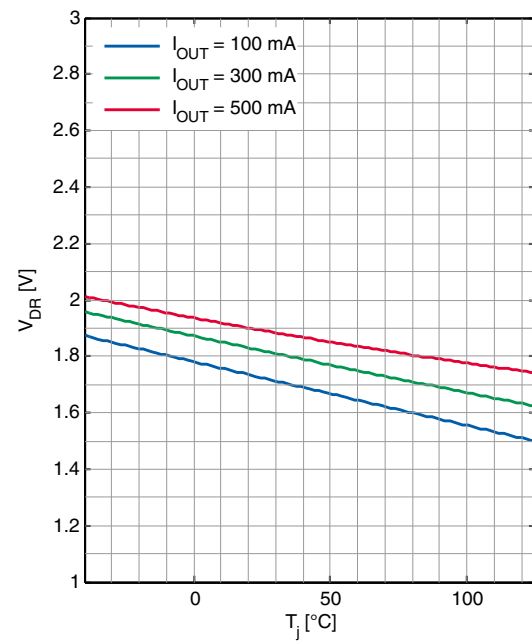



**Drop Voltage  $V_{DR}$  Vs Output Current  $I_{OUT}$**

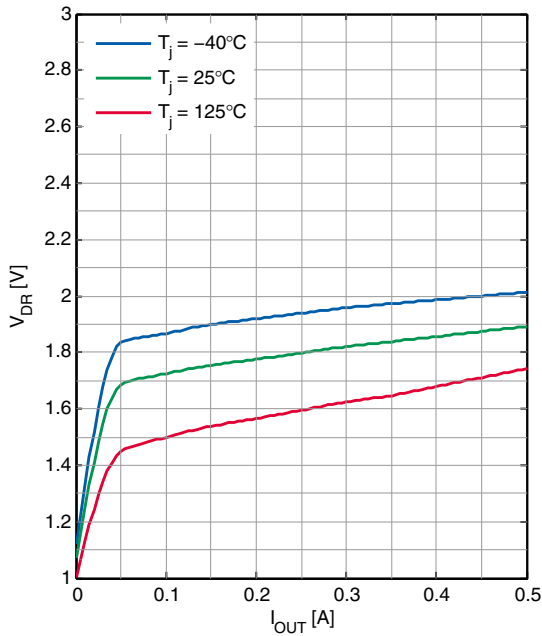

**Current Limit Output Current  $I_{OUT}$  Vs Input Voltage  $V_{IN}$**

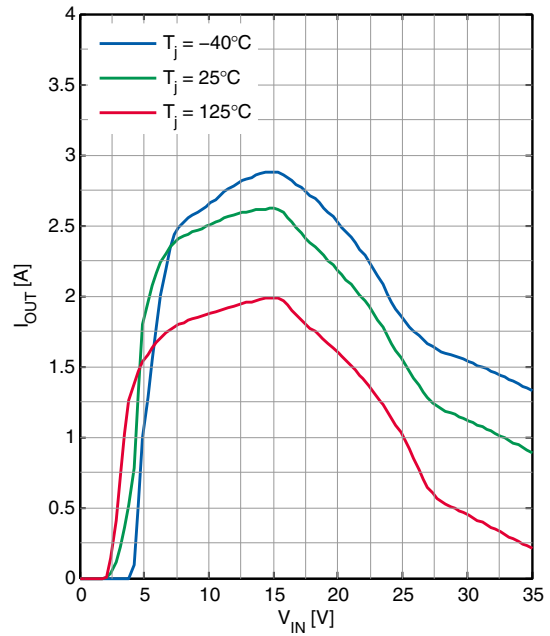

**Line Regulation Output Current  $I_{OUT} = 5\text{mA}$**

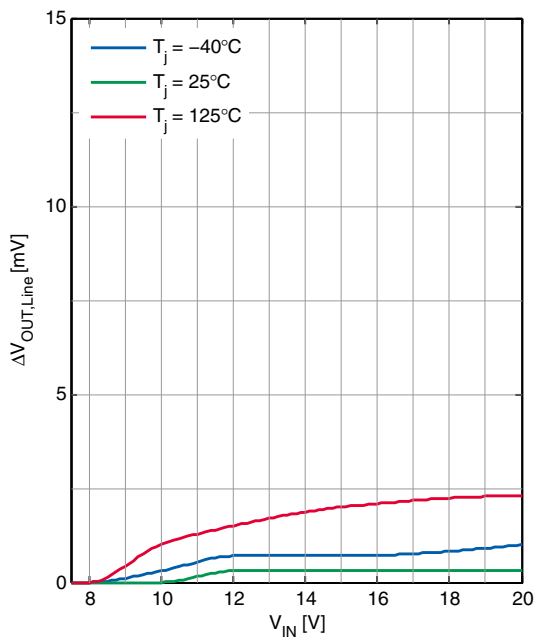

**Line Regulation Output Current  $I_{OUT} = 500\text{mA}$**

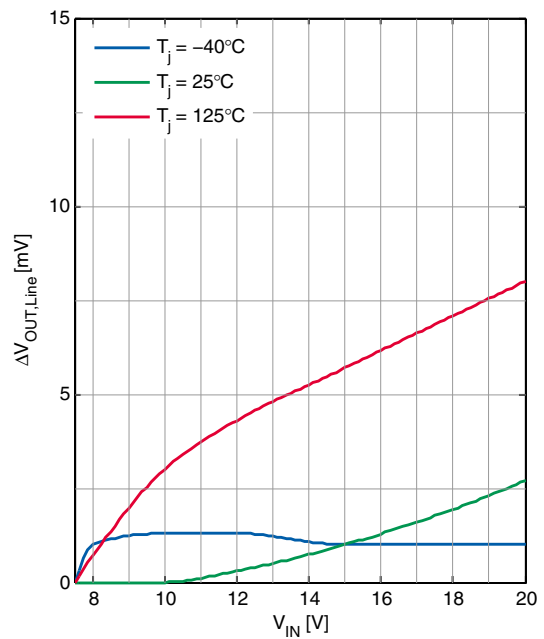

**Load Regulation**  
Input Voltage  $V_{IN} = 7.5V$

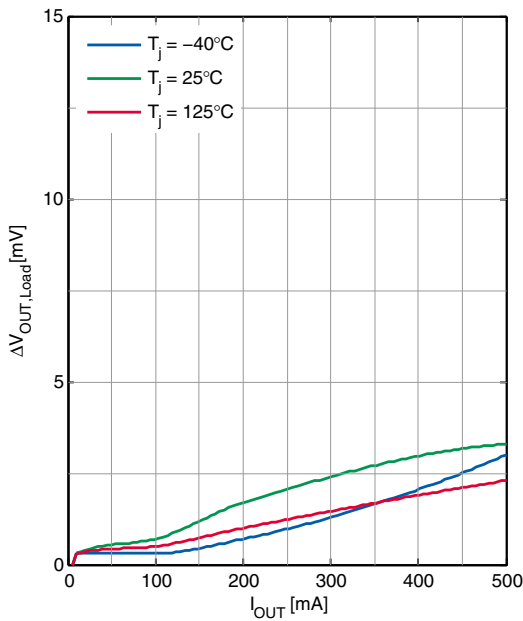

**Load Regulation**  
Input Voltage  $V_{IN} = 20V$

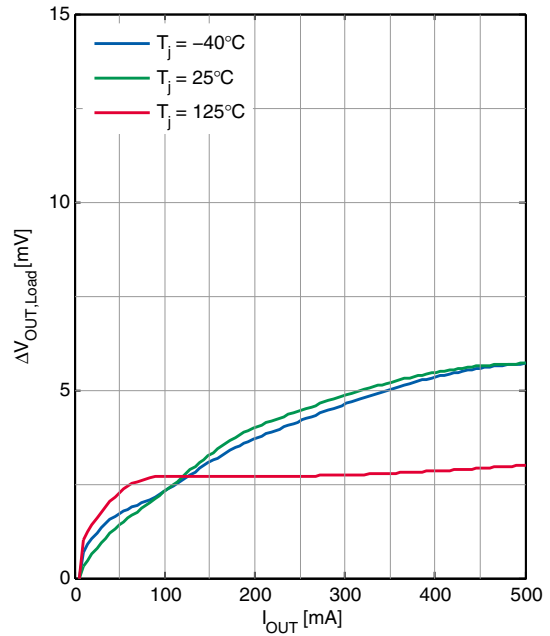

**Current Consumption  $I_q$  Vs Output Current  $I_{OUT}$**

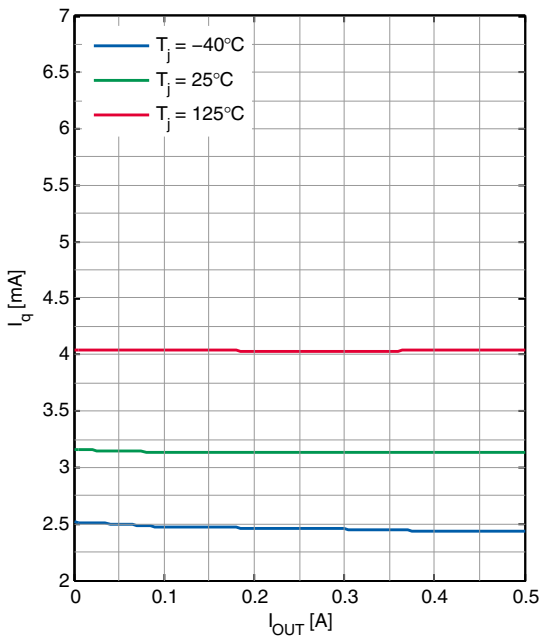

**Current Consumption  $I_q$  Vs Input Voltage  $V_{IN}$**

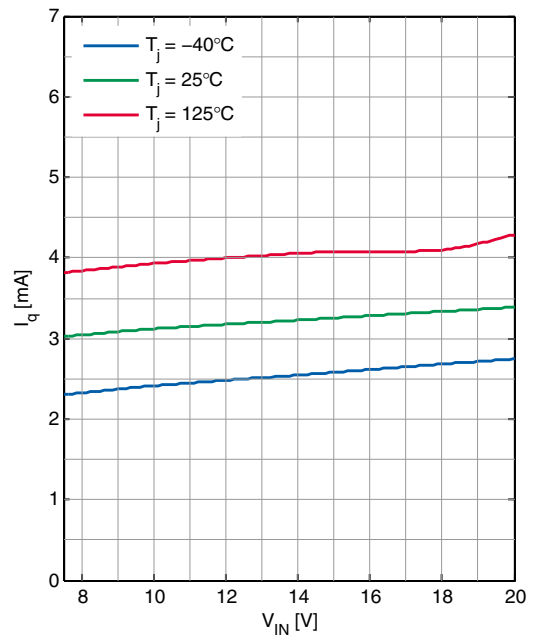

**Power Supply Rejection Ratio**  
Output Current  $I_{OUT} = 10\text{ mA}$

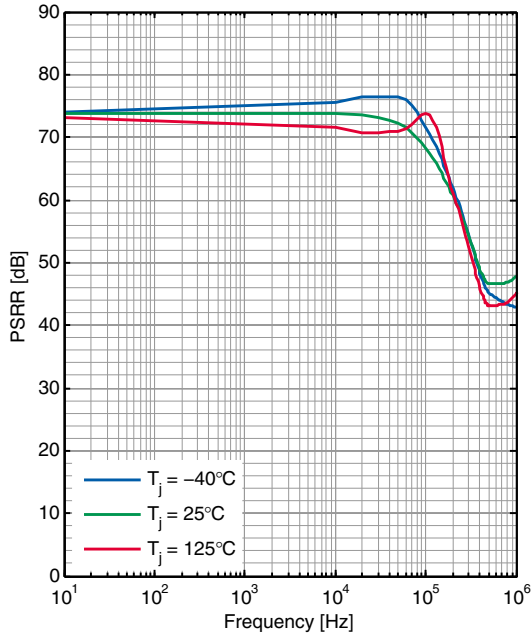

**ESR Tunnel**  
ESR( $C_{OUT}$ ) Vs Output Current  $I_{OUT}$

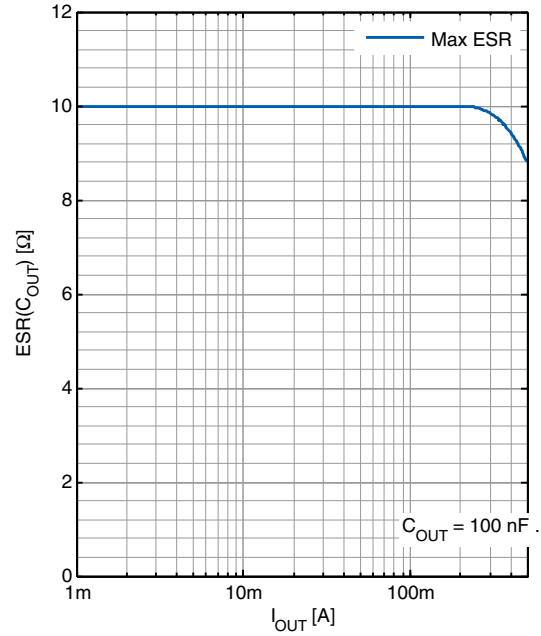

**Line Transient Response**

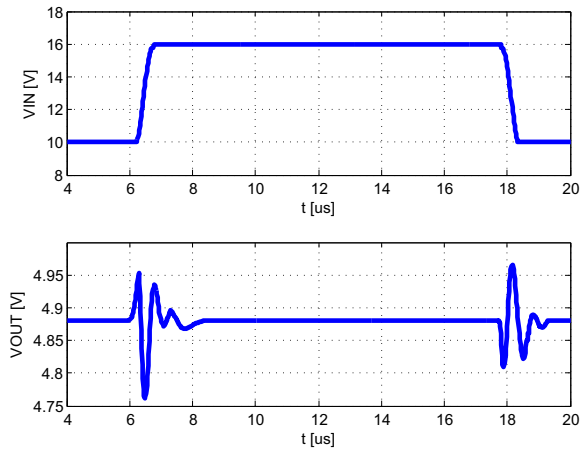

**Load Transient Response**

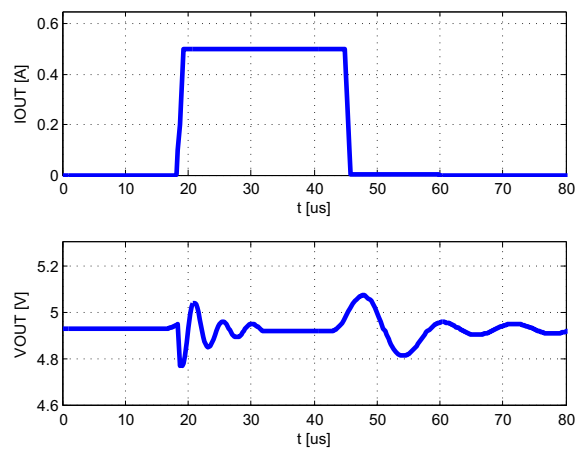

## 6 Application Information

*Note: The following information is given as a hint for the implementation of the device only and shall not be regarded as a description or warranty of a certain functionality, condition or quality of the device.*

### 6.1 Design Considerations

The IFX78M05 linear voltage regulator has an in built thermal overload protection circuitry that shuts down the circuit when subjected to an excessive power overload condition. Thermal shutdown protects the regulator from immediate destruction due to high temperature conditions by turning it off. The thermal shutdown is set to a typical value of 175°C. Operating a linear regulator over the maximum junction temperature significantly reduces the life time of the device and pushes the operating variables outside their specified limits. The device also has an unbolt short circuit protection feature that keeps the output current within the specified bounds to protect both the regulator and the load. The safe-area compensation reduces the output short-circuit current as the voltage across the power stage is increased.

It is recommended that the regulator input is bypassed with a capacitor if the regulator is connected to the power supply filter with long lengths, or if the load capacitance at the output is large. A 0.33µF or larger tantalum or other capacitor, with a low internal impedance at high frequencies, should be chosen. The bypass capacitor should be mounted with the shortest possible leads directly across the input terminals of the regulator.

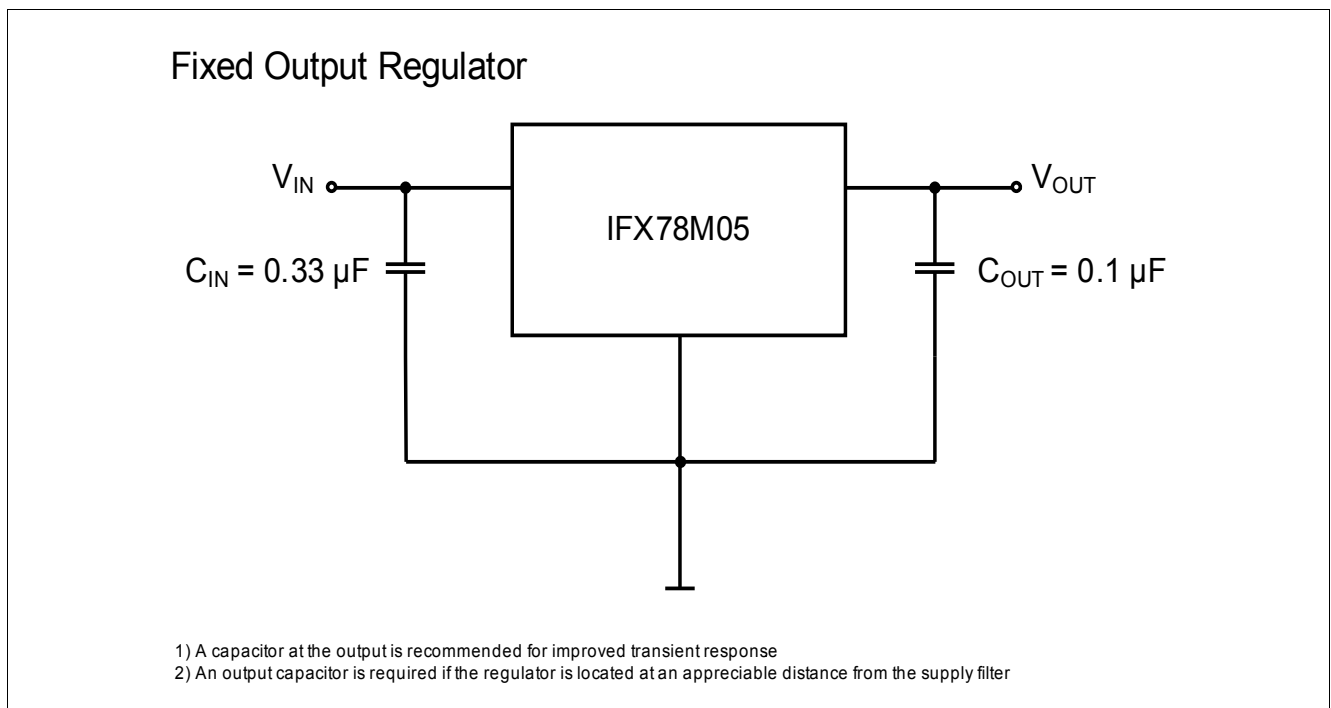

**Figure 3 Typical Application Diagram**

## 7 Package Outlines

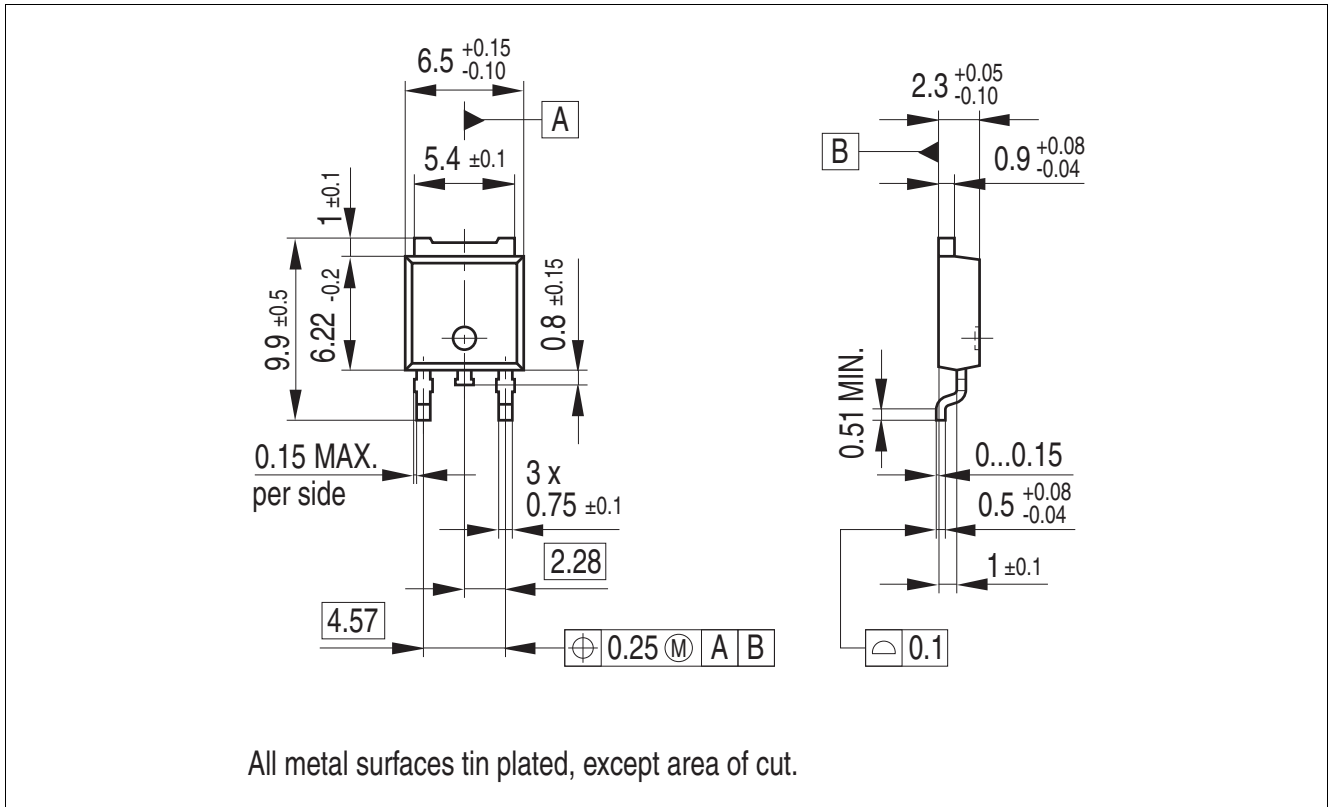

Figure 4 PG-TO-252-3 (Plastic Small Outline Transistor)

### Green Product (RoHS compliant)

To meet the world-wide customer requirements for environmentally friendly products and to be compliant with government regulations the device is available as a green product. Green products are RoHS-Compliant (i.e. Pb-free finish on leads and suitable for Pb-free soldering according to IPC/JEDEC J-STD-020).

For further information on alternative packages, please visit our website:

<http://www.infineon.com/packages>.

Dimensions in mm

## 8 Revision History

Revision	Date	Changes
1.0	2013-07-15	Datasheet - Initial Release

**Edition 2013-07-15**

**Published by  
Infineon Technologies AG  
81726 Munich, Germany**

**© 2011 Infineon Technologies AG  
All Rights Reserved.**

### **Legal Disclaimer**

The information given in this document shall in no event be regarded as a guarantee of conditions or characteristics. With respect to any examples or hints given herein, any typical values stated herein and/or any information regarding the application of the device, Infineon Technologies hereby disclaims any and all warranties and liabilities of any kind, including without limitation, warranties of non-infringement of intellectual property rights of any third party.

### **Information**

For further information on technology, delivery terms and conditions and prices, please contact the nearest Infineon Technologies Office ([www.infineon.com](http://www.infineon.com)).

### **Warnings**

Due to technical requirements, components may contain dangerous substances. For information on the types in question, please contact the nearest Infineon Technologies Office.

The Infineon Technologies component described in this Data Sheet may be used in life-support devices or systems and/or automotive, aviation and aerospace applications or systems only with the express written approval of Infineon Technologies, if a failure of such components can reasonably be expected to cause the failure of that life-support automotive, aviation and aerospace device or system or to affect the safety or effectiveness of that device or system. Life support devices or systems are intended to be implanted in the human body or to support and/or maintain and sustain and/or protect human life. If they fail, it is reasonable to assume that the health of the user or other persons may be endangered.

单击下面可查看定价，库存，交付和生命周期等信息

[>>Infineon Technologies\(英飞凌\)](#)