

MOSFET

600V CoolMOS™ PFD7 SJ Power Device

CoolMOS™ is a revolutionary technology for high voltage power MOSFETs, designed according to the superjunction (SJ) principle and pioneered by Infineon Technologies.

The latest CoolMOS™ PFD7 is an optimized platform tailored to target cost sensitive applications in consumer markets such as charger, adapter, motor drive, lighting, etc.

The new series provides all the benefits of a fast switching Superjunction MOSFET, combined with an excellent price/performance ratio and state of the art ease-of-use level. The technology meets highest efficiency standards and supports high power density, enabling customers going towards very slim designs.

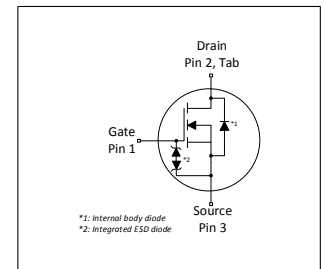

Features

- Extremely low losses due to very low FOM $R_{DS(on)} * Q_g$ and $R_{DS(on)} * E_{oss}$
- Low switching losses E_{oss} , excellent thermal behavior
- Fast body diode
- Wide range portfolio of $R_{DS(on)}$ and package variations
- Integrated zener diode

Benefits

- Enables high power density designs and small form factors
- Enables efficiency gains at higher switching frequencies
- Excellent commutation ruggedness
- Easy to select right parts and optimize the design
- High ESD ruggedness



Potential applications

Recommended for ZVS topologies used in high density chargers, adapters, lighting and motor drives applications, etc.

Product validation

Qualified according to JEDEC Standard

Please note: For MOSFET paralleling the use of ferrite beads on the gate or separate totem poles is generally recommended.

Table 1 Key Performance Parameters

Parameter	Value	Unit
$V_{DS} @ T_{j,max}$	650	V
$R_{DS(on),max}$	360	mΩ
$Q_{g,typ}$	12.7	nC
$I_{D,pulse}$	24	A
$E_{oss} @ 400V$	1.6	μJ
Body diode di_f/dt	1300	A/μs
ESD Class (HBM)	2	-

Type / Ordering Code	Package	Marking	Related Links
IPS60R360PFD7S	PG-TO 251-3	60S360D7	see Appendix A

Table of Contents

Description	1
Maximum ratings	3
Thermal characteristics	4
Electrical characteristics	5
Electrical characteristics diagrams	7
Test Circuits	11
Package Outlines	12
Appendix A	13
Revision History	14
Trademarks	14
Disclaimer	14

1 Maximum ratings

at $T_j = 25^\circ\text{C}$, unless otherwise specified

Table 2 Maximum ratings

Parameter	Symbol	Values			Unit	Note / Test Condition
		Min.	Typ.	Max.		
Continuous drain current ¹⁾	I_D	-	-	10 6	A	$T_C=25^\circ\text{C}$ $T_C=100^\circ\text{C}$
Pulsed drain current ²⁾	$I_{D,pulse}$	-	-	24	A	$T_C=25^\circ\text{C}$
Avalanche energy, single pulse	E_{AS}	-	-	29	mJ	$I_D=2.1\text{A}$; $V_{DD}=50\text{V}$; see table 10
Avalanche energy, repetitive	E_{AR}	-	-	0.14	mJ	$I_D=2.1\text{A}$; $V_{DD}=50\text{V}$; see table 10
Avalanche current, single pulse	I_{AS}	-	-	2.1	A	-
MOSFET dv/dt ruggedness	dv/dt	-	-	120	V/ns	$V_{DS}=0\dots400\text{V}$
Gate source voltage (static)	V_{GS}	-20	-	20	V	static;
Gate source voltage (dynamic)	V_{GS}	-30	-	30	V	AC ($f>1\text{ Hz}$)
Power dissipation	P_{tot}	-	-	43	W	$T_C=25^\circ\text{C}$
Storage temperature	T_{stg}	-40	-	150	$^\circ\text{C}$	-
Operating junction temperature	T_j	-40	-	150	$^\circ\text{C}$	-
Mounting torque	-	-	-	-	Ncm	-
Continuous diode forward current ¹⁾	I_S	-	-	10	A	$T_C=25^\circ\text{C}$
Diode pulse current ²⁾	$I_{S,pulse}$	-	-	24	A	$T_C=25^\circ\text{C}$
Reverse diode dv/dt ³⁾	dv/dt	-	-	70	V/ns	$V_{DS}=0\dots400\text{V}$, $I_{SD}\leq 7.2\text{A}$, $T_j=25^\circ\text{C}$ see table 8
Maximum diode commutation speed	di _F /dt	-	-	1300	A/ μs	$V_{DS}=0\dots400\text{V}$, $I_{SD}\leq 7.2\text{A}$, $T_j=25^\circ\text{C}$ see table 8
Insulation withstand voltage	V_{ISO}	-	-	n.a.	V	V_{rms} , $T_C=25^\circ\text{C}$, $t=1\text{min}$

¹⁾ Limited by $T_{j,max}$. Maximum Duty Cycle $D = 0.50$

²⁾ Pulse width t_p limited by $T_{j,max}$

³⁾ Identical low side and high side switch with identical R_θ

2 Thermal characteristics

Table 3 Thermal characteristics

Parameter	Symbol	Values			Unit	Note / Test Condition
		Min.	Typ.	Max.		
Thermal resistance, junction - case	R_{thJC}	-	-	2.89	°C/W	-
Thermal resistance, junction - ambient	R_{thJA}	-	-	62	°C/W	leaded
Thermal resistance, junction - ambient for SMD version	R_{thJA}	-	-	-	°C/W	n.a.
Soldering temperature, wavesoldering only allowed at leads	T_{sold}	-	-	260	°C	1.6mm (0.063 in.) from case for 10s

3 Electrical characteristics

at $T_j=25^\circ\text{C}$, unless otherwise specified

Table 4 Static characteristics

Parameter	Symbol	Values			Unit	Note / Test Condition
		Min.	Typ.	Max.		
Drain-source breakdown voltage	$V_{(BR)DSS}$	600	-	-	V	$V_{GS}=0\text{V}$, $I_D=1\text{mA}$
Gate threshold voltage	$V_{(GS)th}$	3.5	4	4.5	V	$V_{DS}=V_{GS}$, $I_D=0.14\text{mA}$
Zero gate voltage drain current ¹⁾	I_{DSS}	-	-	1	μA	$V_{DS}=600\text{V}$, $V_{GS}=0\text{V}$, $T_j=25^\circ\text{C}$ $V_{DS}=600\text{V}$, $V_{GS}=0\text{V}$, $T_j=125^\circ\text{C}$
Gate-source leakage current	I_{GSS}	-	-	1000	nA	$V_{GS}=20\text{V}$, $V_{DS}=0\text{V}$
Drain-source on-state resistance	$R_{DS(on)}$	-	0.303 0.714	0.360	Ω	$V_{GS}=10\text{V}$, $I_D=2.9\text{A}$, $T_j=25^\circ\text{C}$ $V_{GS}=10\text{V}$, $I_D=2.9\text{A}$, $T_j=150^\circ\text{C}$
Gate resistance	R_G	-	11.0	-	Ω	$f=1\text{MHz}$, open drain

Table 5 Dynamic characteristics

Parameter	Symbol	Values			Unit	Note / Test Condition
		Min.	Typ.	Max.		
Input capacitance	C_{iss}	-	534	-	pF	$V_{GS}=0\text{V}$, $V_{DS}=400\text{V}$, $f=250\text{kHz}$
Output capacitance	C_{oss}	-	12	-	pF	$V_{GS}=0\text{V}$, $V_{DS}=400\text{V}$, $f=250\text{kHz}$
Effective output capacitance, energy related ²⁾	$C_{o(er)}$	-	20	-	pF	$V_{GS}=0\text{V}$, $V_{DS}=0\dots400\text{V}$
Effective output capacitance, time related ³⁾	$C_{o(tr)}$	-	187	-	pF	$I_D=\text{constant}$, $V_{GS}=0\text{V}$, $V_{DS}=0\dots400\text{V}$
Turn-on delay time	$t_{d(on)}$	-	13.5	-	ns	$V_{DD}=400\text{V}$, $V_{GS}=10\text{V}$, $I_D=2.9\text{A}$, $R_G=10.2\Omega$; see table 9
Rise time	t_r	-	11	-	ns	$V_{DD}=400\text{V}$, $V_{GS}=10\text{V}$, $I_D=2.9\text{A}$, $R_G=10.2\Omega$; see table 9
Turn-off delay time	$t_{d(off)}$	-	46	-	ns	$V_{DD}=400\text{V}$, $V_{GS}=10\text{V}$, $I_D=2.9\text{A}$, $R_G=10.2\Omega$; see table 9
Fall time	t_f	-	13	-	ns	$V_{DD}=400\text{V}$, $V_{GS}=10\text{V}$, $I_D=2.9\text{A}$, $R_G=10.2\Omega$; see table 9

Table 6 Gate charge characteristics

Parameter	Symbol	Values			Unit	Note / Test Condition
		Min.	Typ.	Max.		
Gate to source charge	Q_{GS}	-	3.0	-	nC	$V_{DD}=400\text{V}$, $I_D=2.9\text{A}$, $V_{GS}=0$ to 10V
Gate to drain charge	Q_{gd}	-	4.4	-	nC	$V_{DD}=400\text{V}$, $I_D=2.9\text{A}$, $V_{GS}=0$ to 10V
Gate charge total	Q_g	-	12.7	-	nC	$V_{DD}=400\text{V}$, $I_D=2.9\text{A}$, $V_{GS}=0$ to 10V
Gate plateau voltage	V_{plateau}	-	5.6	-	V	$V_{DD}=400\text{V}$, $I_D=2.9\text{A}$, $V_{GS}=0$ to 10V

¹⁾ Maximum specification is defined by calculated six sigma upper confidence bound

²⁾ $C_{o(er)}$ is a fixed capacitance that gives the same stored energy as C_{oss} while V_{DS} is rising from 0 to 400V

³⁾ $C_{o(tr)}$ is a fixed capacitance that gives the same charging time as C_{oss} while V_{DS} is rising from 0 to 400V

Table 7 Reverse diode characteristics

Parameter	Symbol	Values			Unit	Note / Test Condition
		Min.	Typ.	Max.		
Diode forward voltage	V_{SD}	-	1.0	-	V	$V_{GS}=0V, I_F=2.9A, T_j=25^\circ C$
Reverse recovery time	t_{rr}	-	60	90	ns	$V_R=400V, I_F=2.9A, di_F/dt=100A/\mu s$; see table 8
Reverse recovery charge	Q_{rr}	-	0.14	0.28	μC	$V_R=400V, I_F=2.9A, di_F/dt=100A/\mu s$; see table 8
Peak reverse recovery current	I_{rrm}	-	4.1	-	A	$V_R=400V, I_F=2.9A, di_F/dt=100A/\mu s$; see table 8

4 Electrical characteristics diagrams

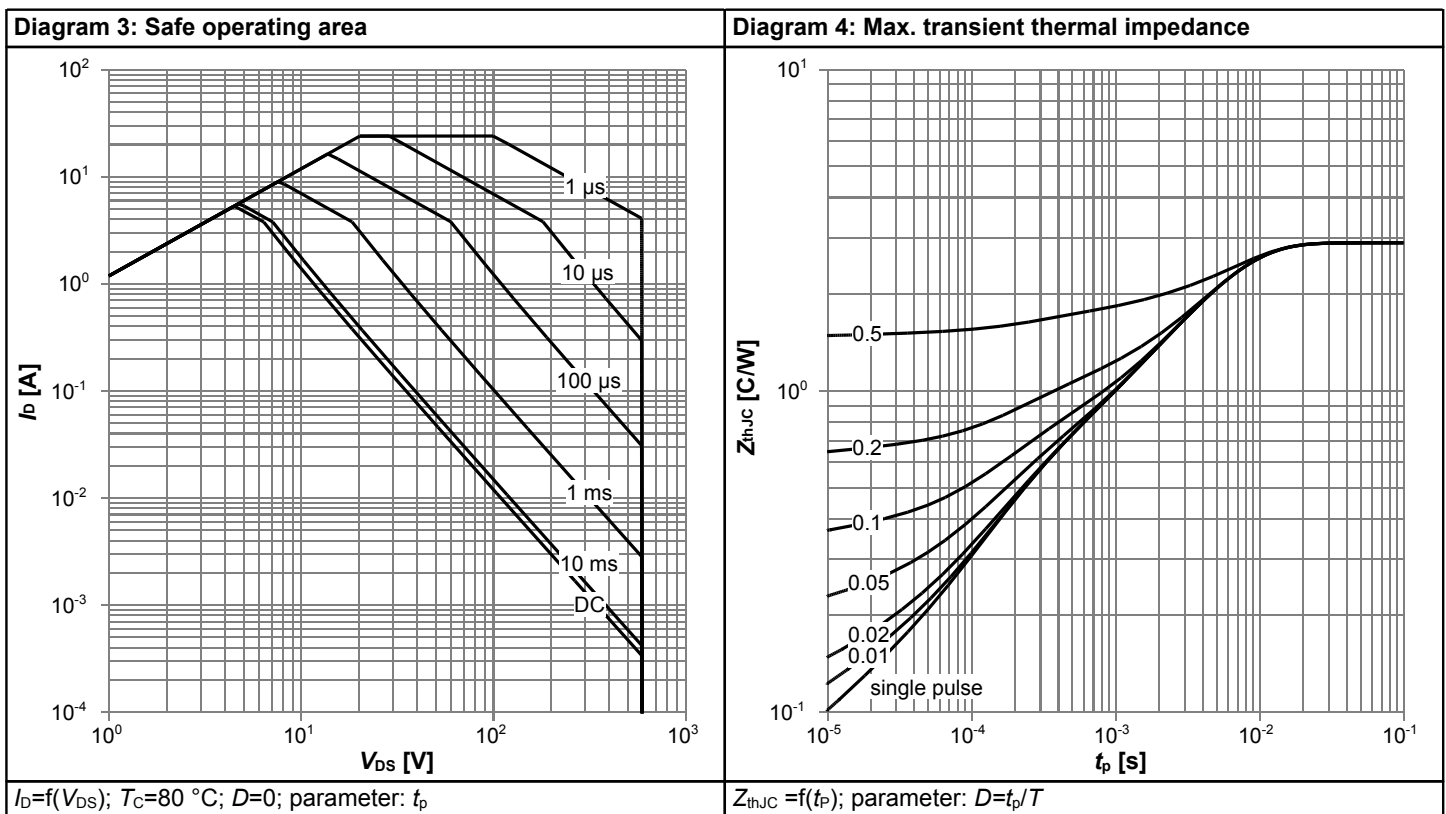
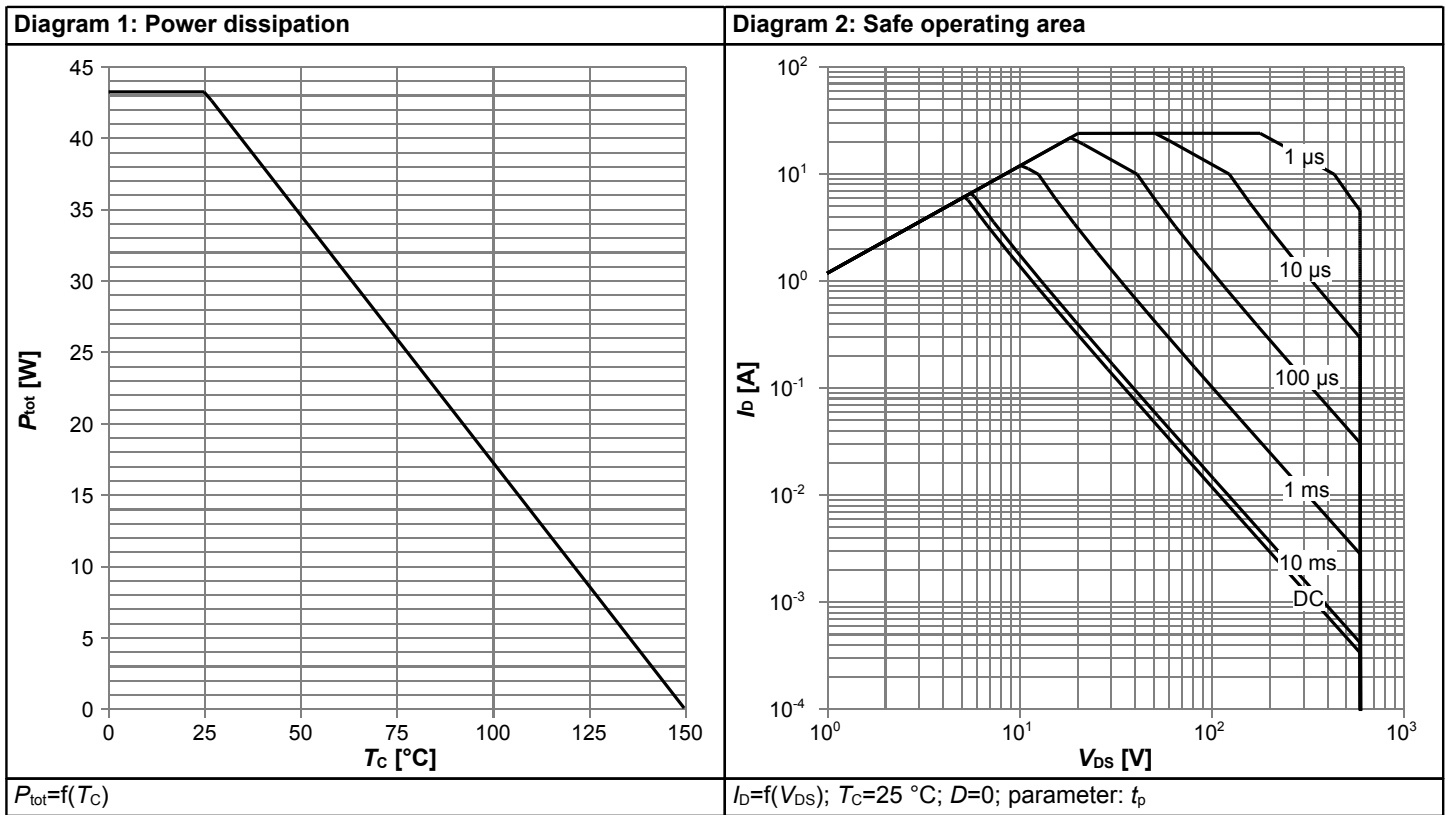
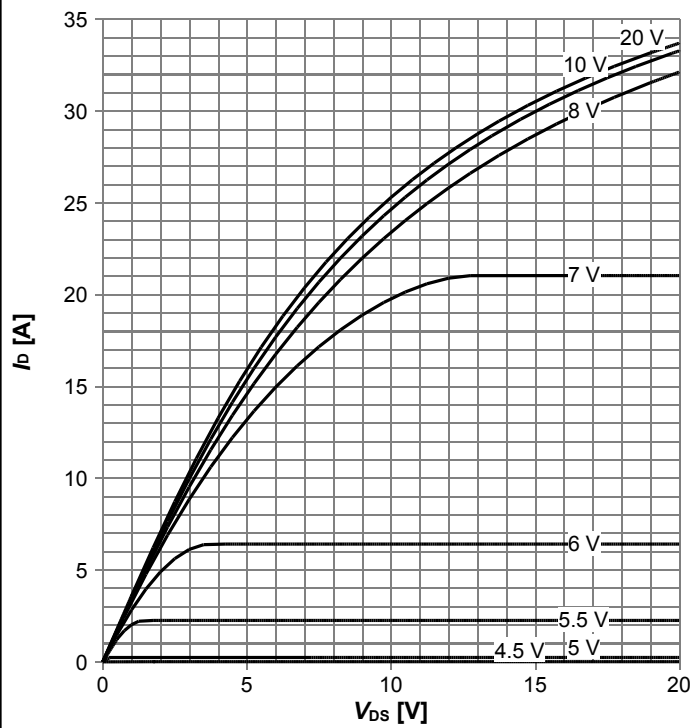
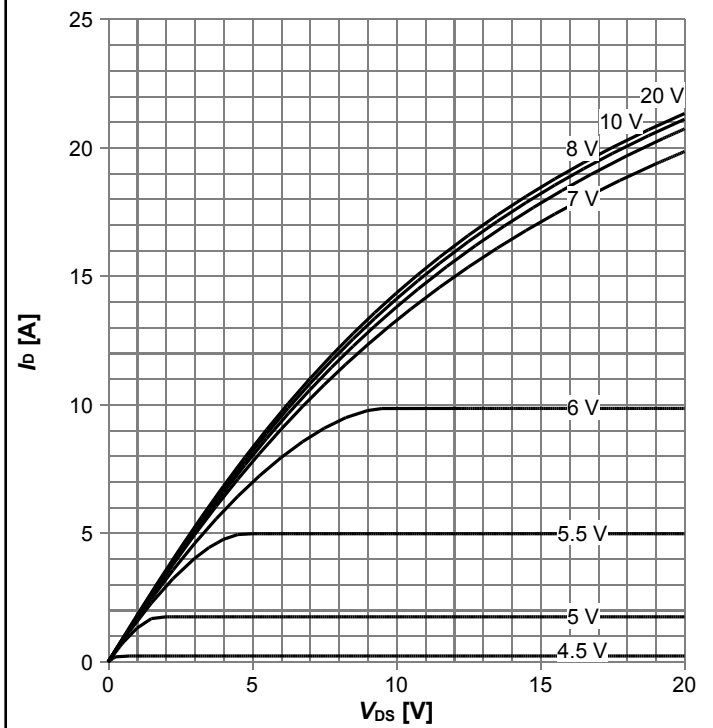

Diagram 5: Typ. output characteristics



$I_D=f(V_{DS})$; $T_j=25\text{ °C}$; parameter: V_{GS}

Diagram 6: Typ. output characteristics



$I_D=f(V_{DS})$; $T_j=125\text{ °C}$; parameter: V_{GS}

Diagram 7: Typ. drain-source on-state resistance

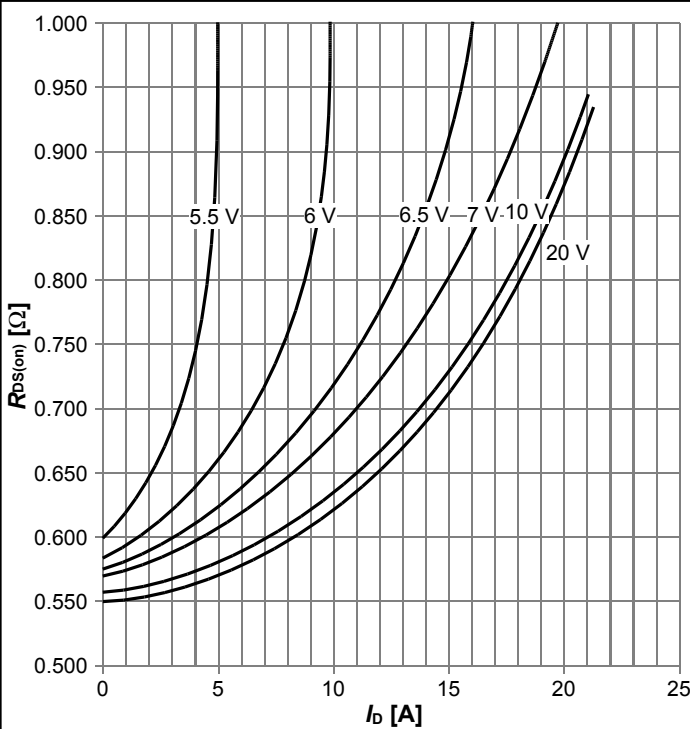

$R_{DS(on)}=f(I_D)$; $T_j=125\text{ °C}$; parameter: V_{GS}

Diagram 8: Drain-source on-state resistance

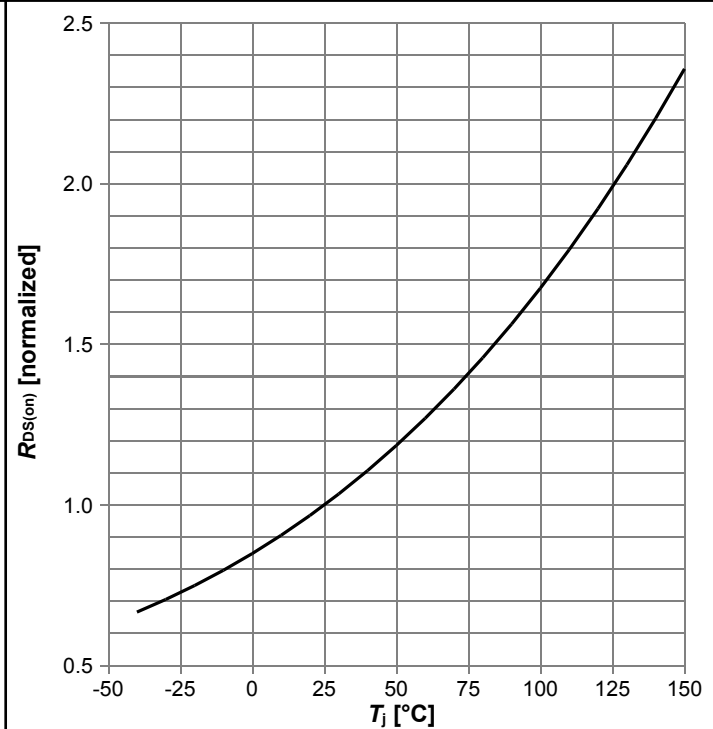

$R_{DS(on)}=f(T_j)$; $I_D=2.9\text{ A}$; $V_{GS}=10\text{ V}$

Diagram 9: Typ. transfer characteristics

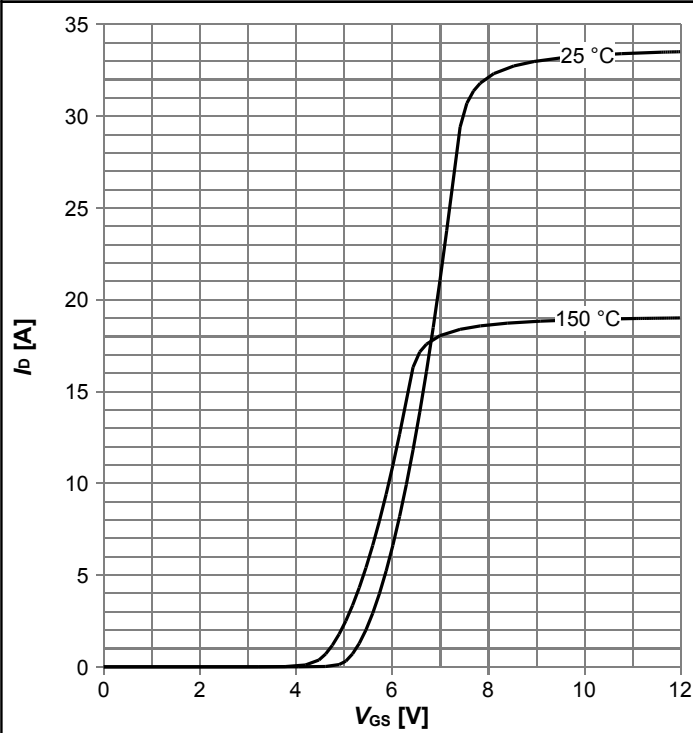

$I_D = f(V_{GS})$; $V_{DS} = 20V$; parameter: T_j

Diagram 10: Typ. gate charge

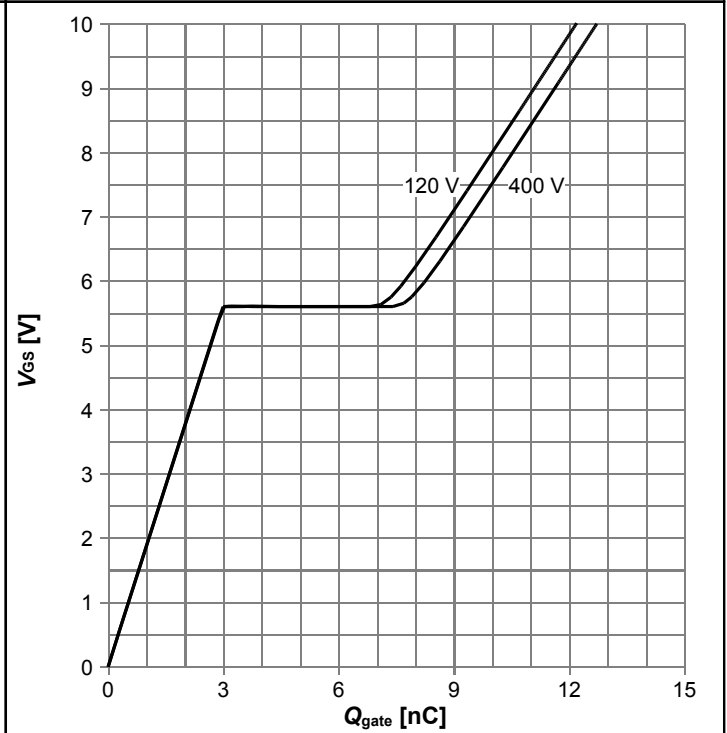

$V_{GS} = f(Q_{gate})$; $I_D = 2.9 A$ pulsed; parameter: V_{DD}

Diagram 11: Forward characteristics of reverse diode

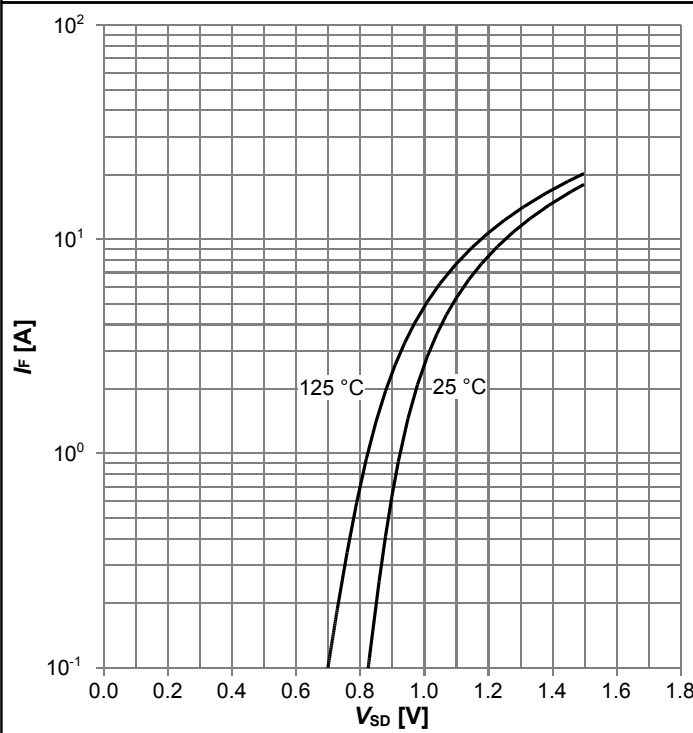

$I_F = f(V_{SD})$; parameter: T_j

Diagram 12: Avalanche energy

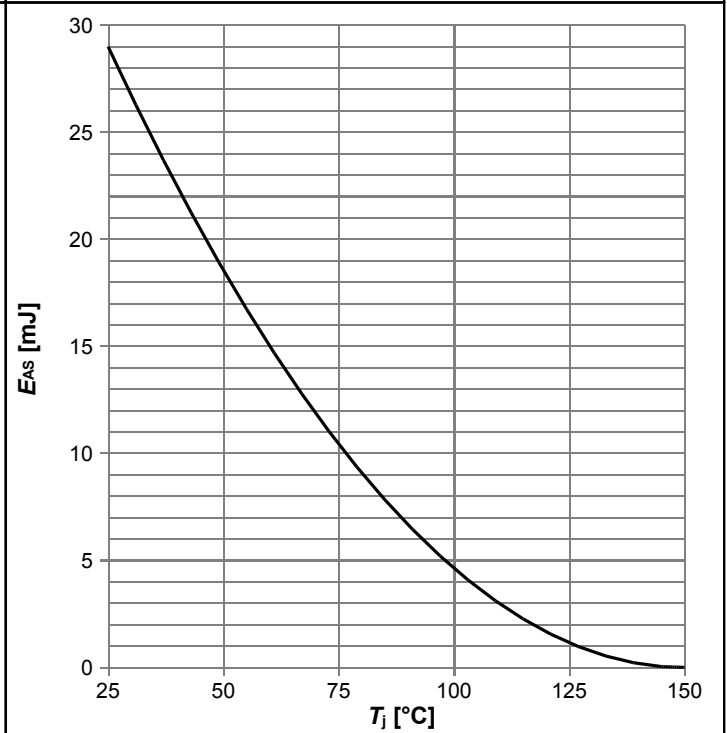

$E_{AS} = f(T_j)$; $I_D = 2.1 A$; $V_{DD} = 50 V$

Diagram 13: Drain-source breakdown voltage

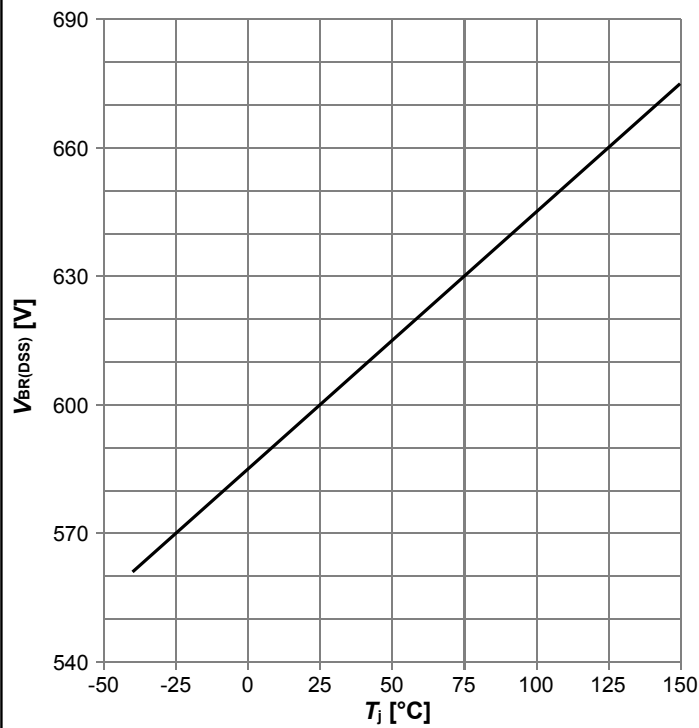

$V_{BR(DSS)}=f(T_j); I_D=1 \text{ mA}$

Diagram 14: Typ. capacitances

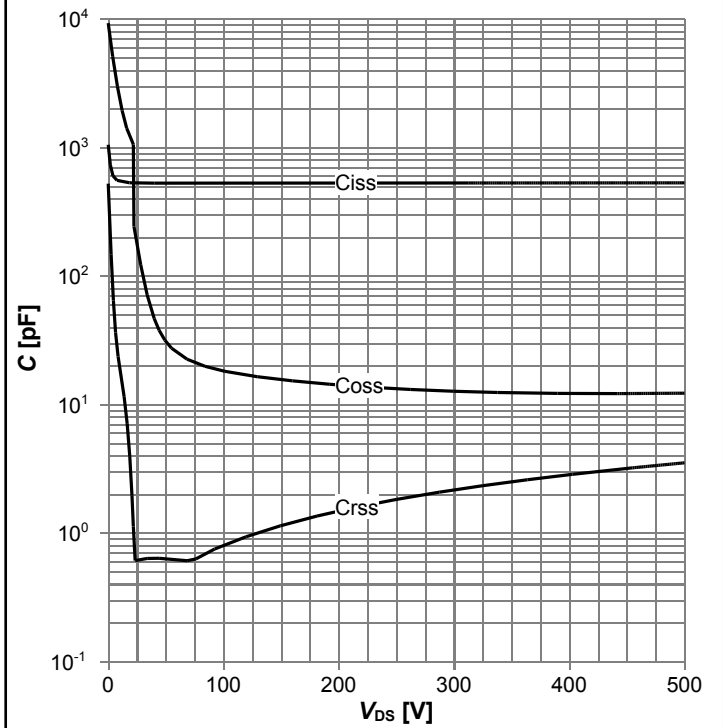

$C=f(V_{DS}); V_{GS}=0 \text{ V}; f=250 \text{ kHz}$

Diagram 15: Typ. Coss stored energy

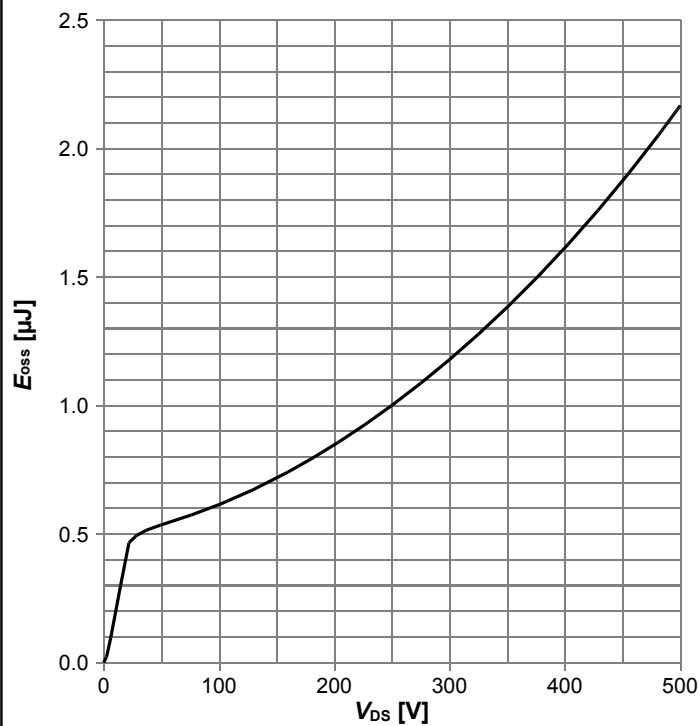

$E_{oss}=f(V_{DS})$

5 Test Circuits

Table 8 Diode characteristics



Table 9 Switching times

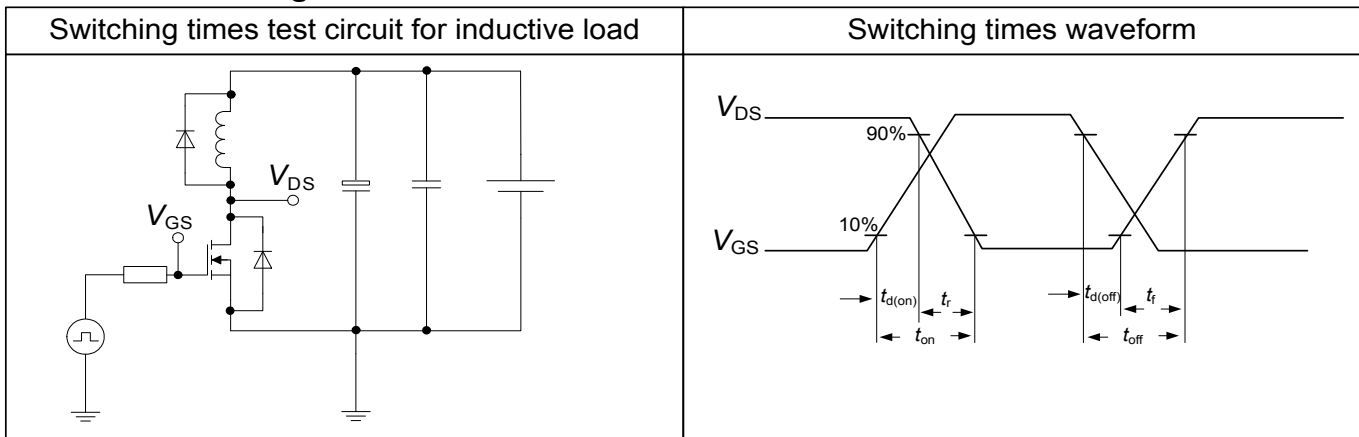
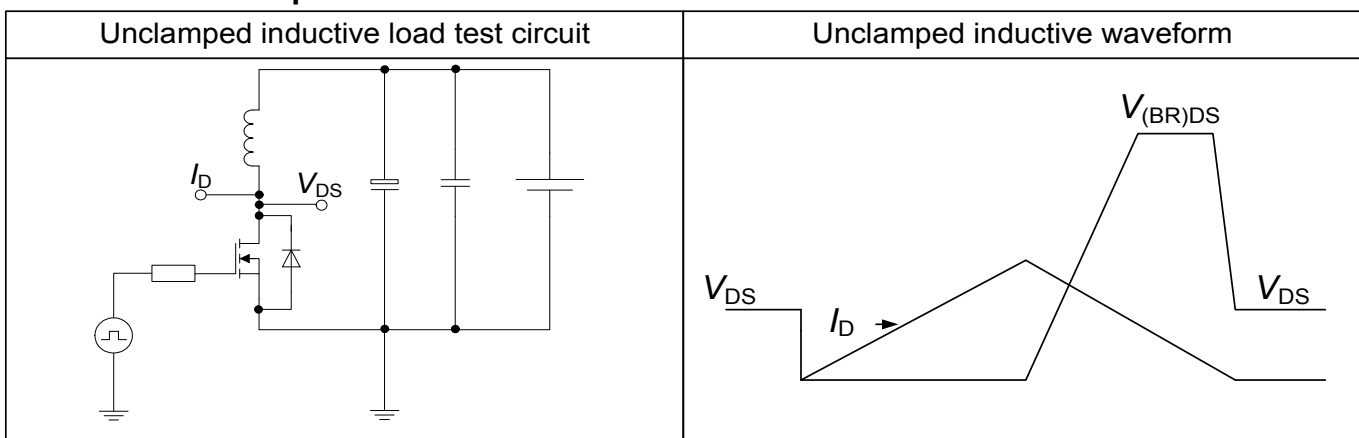
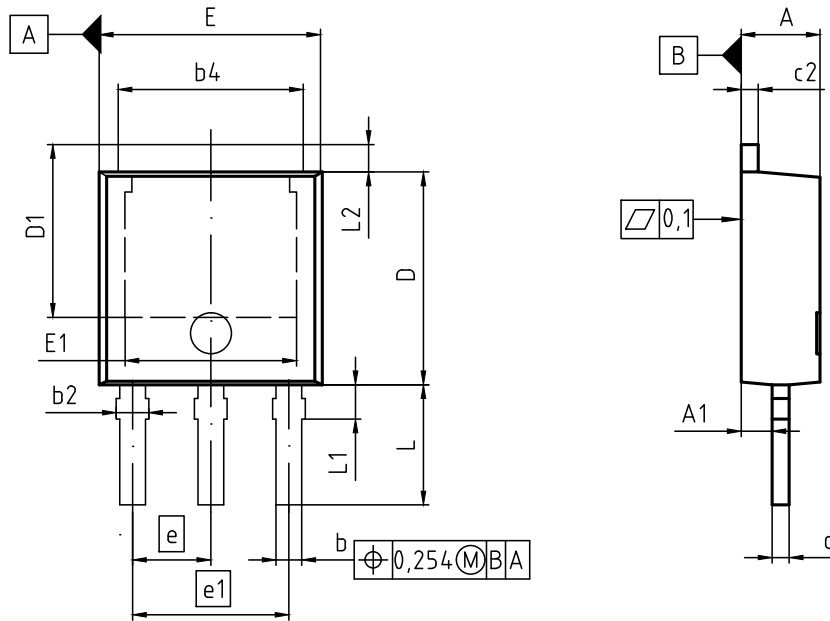

Table 10 Unclamped inductive load



6 Package Outlines



NOTES:

1. STANDARD QUALITY GRADE
2. ALL DIMENSIONS REFER TO JEDEC STANDARD TO-251 DO NOT INCLUDE MOLD FLASH OR PROTRUSIONS.

DIM	MILLIMETERS		INCHES	
	MIN	MAX	MIN	MAX
A	2.20	2.40	0.087	0.094
A1	0.90	1.14	0.035	0.045
b	0.64	0.89	0.025	0.035
b2	0.65	1.15	0.026	0.045
b4	5.20	5.50	0.205	0.217
c	0.46	0.60	0.018	0.024
c2	0.46	0.60	0.018	0.024
D	5.98	6.22	0.235	0.245
D1	5.00	5.60	0.197	0.220
E	6.35	6.73	0.250	0.265
E1	4.63	5.21	0.182	0.205
e	2.29		0.090	
e1	4.57		0.180	
N	3		3	
L	3.30	3.60	0.130	0.142
L1	0.85	1.25	0.033	0.049
L2	0.88	1.28	0.035	0.050

DOCUMENT NO. Z8B00181052
SCALE
EUROPEAN PROJECTION
ISSUE DATE 06-04-2016
REVISION 01

Figure 1 Outline PG-TO 251-3, dimensions in mm/inches

7 Appendix A

Table 11 Related Links

- **IFX CoolMOS PFD7 Webpage:** www.infineon.com
- **IFX CoolMOS PFD7 application note:** www.infineon.com
- **IFX CoolMOS PFD7 simulation model:** www.infineon.com
- **IFX Design tools:** www.infineon.com

Revision History

IPS60R360PFD7S

Revision: 2019-09-27, Rev. 2.0

Previous Revision

Revision	Date	Subjects (major changes since last revision)
2.0	2019-09-27	Release of final version

Trademarks

All referenced product or service names and trademarks are the property of their respective owners.

We Listen to Your Comments

Any information within this document that you feel is wrong, unclear or missing at all? Your feedback will help us to continuously improve the quality of this document. Please send your proposal (including a reference to this document) to:

erratum@infineon.com

Published by

Infineon Technologies AG
81726 München, Germany
© 2019 Infineon Technologies AG
All Rights Reserved.

Legal Disclaimer

The information given in this document shall in no event be regarded as a guarantee of conditions or characteristics ("Beschaffheitsgarantie").

With respect to any examples, hints or any typical values stated herein and/or any information regarding the application of the product, Infineon Technologies hereby disclaims any and all warranties and liabilities of any kind, including without limitation warranties of non-infringement of intellectual property rights of any third party.

In addition, any information given in this document is subject to customer's compliance with its obligations stated in this document and any applicable legal requirements, norms and standards concerning customer's products and any use of the product of Infineon Technologies in customer's applications.

The data contained in this document is exclusively intended for technically trained staff. It is the responsibility of customer's technical departments to evaluate the suitability of the product for the intended application and the completeness of the product information given in this document with respect to such application.

Information

For further information on technology, delivery terms and conditions and prices please contact your nearest Infineon Technologies Office (www.infineon.com).

Warnings

Due to technical requirements, components may contain dangerous substances. For information on the types in question, please contact the nearest Infineon Technologies Office.

The Infineon Technologies component described in this Data Sheet may be used in life-support devices or systems and/or automotive, aviation and aerospace applications or systems only with the express written approval of Infineon Technologies, if a failure of such components can reasonably be expected to cause the failure of that life-support, automotive, aviation and aerospace device or system or to affect the safety or effectiveness of that device or system. Life support devices or systems are intended to be implanted in the human body or to support and/or maintain and sustain and/or protect human life. If they fail, it is reasonable to assume that the health of the user or other persons may be endangered.

单击下面可查看定价，库存，交付和生命周期等信息

[>>Infineon\(英飞凌\)](#)