

Preliminary datasheet

EasyPIM™ module with TRENCHSTOP™ IGBT7 and emitter controlled 7 diode and PressFIT / NTC

Features

- Electrical features
 - $V_{CES} = 1200\text{ V}$
 - $I_{C\text{nom}} = 50\text{ A} / I_{CRM} = 100\text{ A}$
 - Low $V_{CE,sat}$
 - TRENCHSTOP™ IGBT7
 - Overload operation up to 175°C
- Mechanical features
 - Al_2O_3 substrate with low thermal resistance
 - PressFIT contact technology
 - 2.5 kV AC 1 minute insulation
 - Compact design
 - High power density

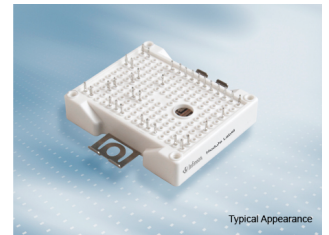

Potential applications

- Motor drives
- Auxiliary inverters
- Air conditioning

Product validation

- Qualified for industrial applications according to the relevant tests of IEC 60747, 60749 and 60068

Description

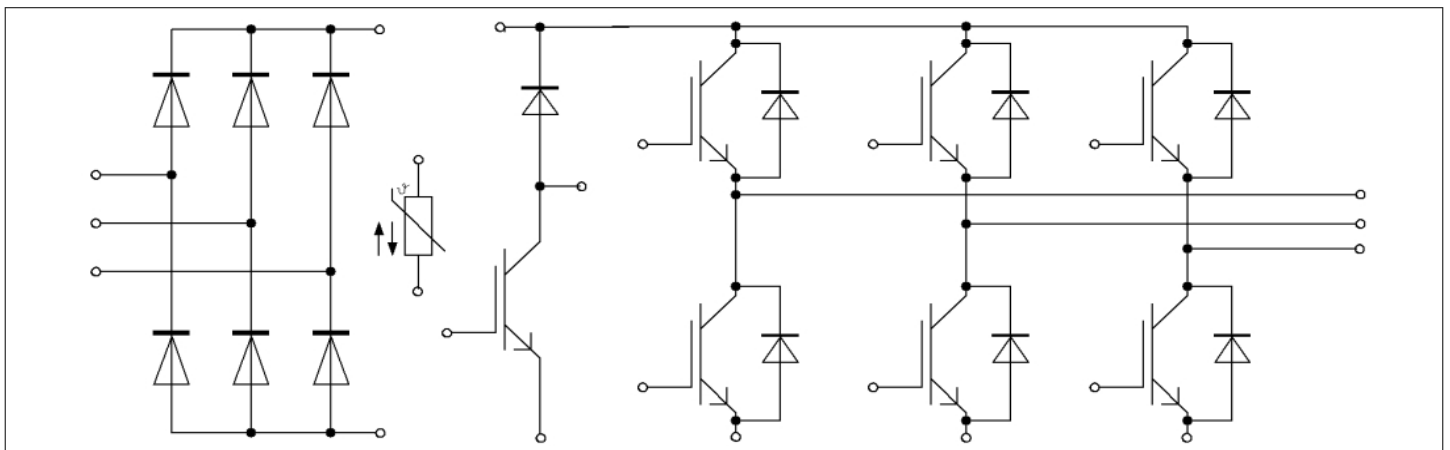

Table of contents

	Description	1
	Features	1
	Potential applications	1
	Product validation	1
	Table of contents	2
1	Package	3
2	IGBT, Inverter	3
3	Diode, Inverter	5
4	Diode, Rectifier	6
5	IGBT, Brake-Chopper	7
6	Diode, Brake-Chopper	8
7	NTC-Thermistor	9
8	Characteristics diagrams	10
9	Circuit diagram	16
10	Package outlines	17
11	Module label code	18
	Revision history	19
	Disclaimer	20

1 Package

Table 1 Insulation coordination

Parameter	Symbol	Note or test condition	Values	Unit
Isolation test voltage	V_{ISOL}	RMS, $f = 50$ Hz, $t = 1$ min	2.5	kV
Internal isolation		basic insulation (class 1, IEC 61140)	Al_2O_3	
Creepage distance	d_{Creep}	terminal to heatsink	11.5	mm
Creepage distance	d_{Creep}	terminal to terminal	6.3	mm
Clearance	d_{Clear}	terminal to heatsink	10.0	mm
Clearance	d_{Clear}	terminal to terminal	5.0	mm
Comparative tracking index	CTI		> 200	
Relative thermal index (electrical)	RTI	housing	140	°C

Table 2 Characteristic values

Parameter	Symbol	Note or test condition	Values			Unit
			Min.	Typ.	Max.	
Stray inductance module	L_{SCE}			30		nH
Module lead resistance, terminals - chip	$R_{AA'+CC'}$	$T_H = 25$ °C, per switch		6		mΩ
Module lead resistance, terminals - chip	$R_{CC'+EE'}$	$T_H = 25$ °C, per switch		5		mΩ
Storage temperature	T_{stg}		-40		125	°C
Mounting force per clamp	F		40		80	N
Weight	G			39		g

Note: The current under continuous operation is limited to 25 A rms per connector pin. $T_{vj\ op} > 150$ °C is allowed for operation at overload conditions. For detailed specifications, please refer to AN 2018-14.

2 IGBT, Inverter

Table 3 Maximum rated values

Parameter	Symbol	Note or test condition	Values	Unit
Collector-emitter voltage	V_{CES}	$T_{vj} = 25$ °C	1200	V
Continuous DC collector current	I_{CDC}	$T_{vj\ max} = 175$ °C $T_H = 80$ °C	50	A
Repetitive peak collector current	I_{CRM}	t_p limited by $T_{vj\ op}$	100	A
Gate-emitter peak voltage	V_{GES}		±20	V

Table 4 Characteristic values

Parameter	Symbol	Note or test condition		Values			Unit
				Min.	Typ.	Max.	
Collector-emitter saturation voltage	$V_{CE\ sat}$	$I_C = 50\ A, V_{GE} = 15\ V$	$T_{vj} = 25\ ^\circ C$		1.50	TBD	V
			$T_{vj} = 125\ ^\circ C$		1.64		
			$T_{vj} = 175\ ^\circ C$		1.72		
Gate threshold voltage	V_{GETh}	$I_C = 1.28\ mA, V_{CE} = V_{GE}, T_{vj} = 25\ ^\circ C$		5.15	5.80	6.45	V
Gate charge	Q_G	$V_{GE} = \pm 15\ V, V_{CC} = 600\ V$			0.92		μC
Internal gate resistor	R_{Gint}	$T_{vj} = 25\ ^\circ C$			0		Ω
Input capacitance	C_{ies}	$f = 100\ kHz, T_{vj} = 25\ ^\circ C, V_{CE} = 25\ V, V_{GE} = 0\ V$			11.1		nF
Reverse transfer capacitance	C_{res}	$f = 100\ kHz, T_{vj} = 25\ ^\circ C, V_{CE} = 25\ V, V_{GE} = 0\ V$			0.039		nF
Collector-emitter cut-off current	I_{CES}	$V_{CE} = 1200\ V, V_{GE} = 0\ V$	$T_{vj} = 25\ ^\circ C$			0.008	mA
Gate-emitter leakage current	I_{GES}	$V_{CE} = 0\ V, V_{GE} = 20\ V, T_{vj} = 25\ ^\circ C$				100	nA
Turn-on delay time (inductive load)	t_{don}	$I_C = 50\ A, V_{CC} = 600\ V, V_{GE} = \pm 15\ V, R_{Gon} = 5.1\ \Omega$	$T_{vj} = 25\ ^\circ C$		0.051		μs
			$T_{vj} = 125\ ^\circ C$		0.054		
			$T_{vj} = 175\ ^\circ C$		0.055		
Rise time (inductive load)	t_r	$I_C = 50\ A, V_{CC} = 600\ V, V_{GE} = \pm 15\ V, R_{Gon} = 5.1\ \Omega$	$T_{vj} = 25\ ^\circ C$		0.027		μs
			$T_{vj} = 125\ ^\circ C$		0.028		
			$T_{vj} = 175\ ^\circ C$		0.029		
Turn-off delay time (inductive load)	t_{doff}	$I_C = 50\ A, V_{CC} = 600\ V, V_{GE} = \pm 15\ V, R_{Goff} = 5.1\ \Omega$	$T_{vj} = 25\ ^\circ C$		0.265		μs
			$T_{vj} = 125\ ^\circ C$		0.335		
			$T_{vj} = 175\ ^\circ C$		0.382		
Fall time (inductive load)	t_f	$I_C = 50\ A, V_{CC} = 600\ V, V_{GE} = \pm 15\ V, R_{Goff} = 5.1\ \Omega$	$T_{vj} = 25\ ^\circ C$		0.111		μs
			$T_{vj} = 125\ ^\circ C$		0.185		
			$T_{vj} = 175\ ^\circ C$		0.277		
Turn-on energy loss per pulse	E_{on}	$I_C = 50\ A, V_{CC} = 600\ V, L_\sigma = 35\ nH, V_{GE} = \pm 15\ V, R_{Gon} = 5.1\ \Omega, di/dt = 1700\ A/\mu s (T_{vj} = 175\ ^\circ C)$	$T_{vj} = 25\ ^\circ C$		3.24		mJ
			$T_{vj} = 125\ ^\circ C$		4.49		
			$T_{vj} = 175\ ^\circ C$		5.21		
Turn-off energy loss per pulse	E_{off}	$I_C = 50\ A, V_{CC} = 600\ V, L_\sigma = 35\ nH, V_{GE} = \pm 15\ V, R_{Goff} = 5.1\ \Omega, dv/dt = 2900\ V/\mu s (T_{vj} = 175\ ^\circ C)$	$T_{vj} = 25\ ^\circ C$		3.84		mJ
			$T_{vj} = 125\ ^\circ C$		5.54		
			$T_{vj} = 175\ ^\circ C$		6.63		

(table continues...)

Table 4 (continued) Characteristic values

Parameter	Symbol	Note or test condition	Values			Unit
			Min.	Typ.	Max.	
SC data	I_{SC}	$V_{GE} \leq 15 \text{ V}, V_{CC} = 800 \text{ V}, V_{CEmax} = V_{CES} - L_{SCE} \cdot di/dt$	$t_p \leq 8 \mu\text{s}, T_{vj} = 150 \text{ }^\circ\text{C}$		190	A
			$t_p \leq 7 \mu\text{s}, T_{vj} = 175 \text{ }^\circ\text{C}$		180	
Thermal resistance, junction to heat sink	R_{thJH}	per IGBT, $\lambda_{grease} = 1 \text{ W}/(\text{m}\cdot\text{K})$		0.910		K/W
Temperature under switching conditions	$T_{vj\text{ op}}$		-40		175	$^\circ\text{C}$

3 Diode, Inverter

Table 5 Maximum rated values

Parameter	Symbol	Note or test condition	Values	Unit	
Repetitive peak reverse voltage	V_{RRM}	$T_{vj} = 25 \text{ }^\circ\text{C}$	1200	V	
Continuous DC forward current	I_F		50	A	
Repetitive peak forward current	I_{FRM}	$t_p = 1 \text{ ms}$	100	A	
I^2t - value	I^2t	$t_p = 10 \text{ ms}, V_R = 0 \text{ V}$	$T_{vj} = 125 \text{ }^\circ\text{C}$	300	A^2s
			$T_{vj} = 175 \text{ }^\circ\text{C}$	250	

Table 6 Characteristic values

Parameter	Symbol	Note or test condition	Values			Unit	
			Min.	Typ.	Max.		
Forward voltage	V_F	$I_F = 50 \text{ A}, V_{GE} = 0 \text{ V}$	$T_{vj} = 25 \text{ }^\circ\text{C}$		1.72	TBD	V
			$T_{vj} = 125 \text{ }^\circ\text{C}$		1.59		
			$T_{vj} = 175 \text{ }^\circ\text{C}$		1.52		
Peak reverse recovery current	I_{RM}	$V_{CC} = 600 \text{ V}, I_F = 50 \text{ A}, V_{GE} = -15 \text{ V}, -di_F/dt = 1700 \text{ A}/\mu\text{s} (T_{vj} = 175 \text{ }^\circ\text{C})$	$T_{vj} = 25 \text{ }^\circ\text{C}$		48.2		A
			$T_{vj} = 125 \text{ }^\circ\text{C}$		65.5		
			$T_{vj} = 175 \text{ }^\circ\text{C}$		77.8		
Recovered charge	Q_r	$V_{CC} = 600 \text{ V}, I_F = 50 \text{ A}, V_{GE} = -15 \text{ V}, -di_F/dt = 1700 \text{ A}/\mu\text{s} (T_{vj} = 175 \text{ }^\circ\text{C})$	$T_{vj} = 25 \text{ }^\circ\text{C}$		4.36		μC
			$T_{vj} = 125 \text{ }^\circ\text{C}$		7.52		
			$T_{vj} = 175 \text{ }^\circ\text{C}$		9.82		

(table continues...)

Table 6 (continued) Characteristic values

Parameter	Symbol	Note or test condition	Values			Unit
			Min.	Typ.	Max.	
Reverse recovery energy	E_{rec}	$V_{CC} = 600\text{ V}$, $I_F = 50\text{ A}$, $V_{GE} = -15\text{ V}$, $-di_F/dt = 1700\text{ A}/\mu\text{s}$ ($T_{vj} = 175\text{ °C}$)	$T_{vj} = 25\text{ °C}$		1.57	mJ
			$T_{vj} = 125\text{ °C}$		2.95	
			$T_{vj} = 175\text{ °C}$		3.95	
Thermal resistance, junction to heat sink	R_{thJH}	per diode, $\lambda_{grease} = 1\text{ W}/(\text{m}\cdot\text{K})$		1.20		K/W
Temperature under switching conditions	$T_{vj,op}$		-40		175	°C

4 Diode, Rectifier

Table 7 Maximum rated values

Parameter	Symbol	Note or test condition	Values	Unit	
Repetitive peak reverse voltage	V_{RRM}	$T_{vj} = 25\text{ °C}$	1600	V	
Maximum RMS forward current per chip	I_{FRMSM}	$T_H = 90\text{ °C}$	50	A	
Maximum RMS current at rectifier output	I_{RMSM}	$T_H = 90\text{ °C}$	50	A	
Surge forward current	I_{FSM}	$t_p = 10\text{ ms}$	$T_{vj} = 25\text{ °C}$	450	A
			$T_{vj} = 150\text{ °C}$	370	
I^2t - value	I^2t	$t_p = 10\text{ ms}$	$T_{vj} = 25\text{ °C}$	1010	A ² s
			$T_{vj} = 150\text{ °C}$	685	

Table 8 Characteristic values

Parameter	Symbol	Note or test condition	Values			Unit
			Min.	Typ.	Max.	
Forward voltage	V_F	$I_F = 50\text{ A}$, $T_{vj} = 150\text{ °C}$		1.09		V
Reverse current	I_r	$T_{vj} = 150\text{ °C}$, $V_R = 1600\text{ V}$		0.18		mA
Thermal resistance, junction to heat sink	R_{thJH}	per diode, $\lambda_{grease} = 1\text{ W}/(\text{m}\cdot\text{K})$		1.24		K/W
Temperature under switching conditions	$T_{vj,op}$		-40		150	°C

5 IGBT, Brake-Chopper

Table 9 Maximum rated values

Parameter	Symbol	Note or test condition	Values	Unit
Collector-emitter voltage	V_{CES}	$T_{vj} = 25\text{ °C}$	1200	V
Continuous DC collector current	I_{CDC}	$T_{vj\ max} = 175\text{ °C}$ $T_H = 90\text{ °C}$	35	A
Repetitive peak collector current	I_{CRM}	t_p limited by $T_{vj\ op}$	70	A
Gate-emitter peak voltage	V_{GES}		± 20	V

Table 10 Characteristic values

Parameter	Symbol	Note or test condition	Values			Unit
			Min.	Typ.	Max.	
Collector-emitter saturation voltage	$V_{CE\ sat}$	$I_C = 35\text{ A}, V_{GE} = 15\text{ V}$	$T_{vj} = 25\text{ °C}$	1.60	TBD	V
			$T_{vj} = 125\text{ °C}$	1.74		
			$T_{vj} = 175\text{ °C}$	1.82		
Gate threshold voltage	V_{GETh}	$I_C = 0.75\text{ mA}, V_{CE} = V_{GE}, T_{vj} = 25\text{ °C}$	5.15	5.80	6.45	V
Gate charge	Q_G	$V_{GE} = \pm 15\text{ V}, V_{CC} = 600\text{ V}$		0.548		μC
Internal gate resistor	R_{Gint}	$T_{vj} = 25\text{ °C}$		0		Ω
Input capacitance	C_{ies}	$f = 100\text{ kHz}, T_{vj} = 25\text{ °C}, V_{CE} = 25\text{ V}, V_{GE} = 0\text{ V}$		6.62		nF
Reverse transfer capacitance	C_{res}	$f = 100\text{ kHz}, T_{vj} = 25\text{ °C}, V_{CE} = 25\text{ V}, V_{GE} = 0\text{ V}$		0.023		nF
Collector-emitter cut-off current	I_{CES}	$V_{CE} = 1200\text{ V}, V_{GE} = 0\text{ V}$ $T_{vj} = 25\text{ °C}$			0.005	mA
Gate-emitter leakage current	I_{GES}	$V_{CE} = 0\text{ V}, V_{GE} = 20\text{ V}, T_{vj} = 25\text{ °C}$			100	nA
Turn-on delay time (inductive load)	t_{don}	$I_C = 35\text{ A}, V_{CC} = 600\text{ V}, V_{GE} = \pm 15\text{ V}, R_{Gon} = 5.6\ \Omega$	$T_{vj} = 25\text{ °C}$	0.043		μs
			$T_{vj} = 125\text{ °C}$	0.046		
			$T_{vj} = 175\text{ °C}$	0.048		
Rise time (inductive load)	t_r	$I_C = 35\text{ A}, V_{CC} = 600\text{ V}, V_{GE} = \pm 15\text{ V}, R_{Gon} = 5.6\ \Omega$	$T_{vj} = 25\text{ °C}$	0.036		μs
			$T_{vj} = 125\text{ °C}$	0.038		
			$T_{vj} = 175\text{ °C}$	0.039		
Turn-off delay time (inductive load)	t_{doff}	$I_C = 35\text{ A}, V_{CC} = 600\text{ V}, V_{GE} = \pm 15\text{ V}, R_{Goff} = 5.6\ \Omega$	$T_{vj} = 25\text{ °C}$	0.240		μs
			$T_{vj} = 125\text{ °C}$	0.310		
			$T_{vj} = 175\text{ °C}$	0.340		
Fall time (inductive load)	t_f	$I_C = 35\text{ A}, V_{CC} = 600\text{ V}, V_{GE} = \pm 15\text{ V}, R_{Goff} = 5.6\ \Omega$	$T_{vj} = 25\text{ °C}$	0.120		μs
			$T_{vj} = 125\text{ °C}$	0.210		
			$T_{vj} = 175\text{ °C}$	0.270		

(table continues...)

Table 10 (continued) **Characteristic values**

Parameter	Symbol	Note or test condition	Values			Unit
			Min.	Typ.	Max.	
Turn-on energy loss per pulse	E_{on}	$I_C = 35\text{ A}$, $V_{CC} = 600\text{ V}$, $L_\sigma = 35\text{ nH}$, $V_{GE} = \pm 15\text{ V}$, $R_{Gon} = 5.6\ \Omega$, $di/dt = 590\text{ A}/\mu\text{s}$ ($T_{vj} = 175\text{ }^\circ\text{C}$)	$T_{vj} = 25\text{ }^\circ\text{C}$	2.84		mJ
			$T_{vj} = 125\text{ }^\circ\text{C}$	3.38		
			$T_{vj} = 175\text{ }^\circ\text{C}$	3.61		
Turn-off energy loss per pulse	E_{off}	$I_C = 35\text{ A}$, $V_{CC} = 600\text{ V}$, $L_\sigma = 35\text{ nH}$, $V_{GE} = \pm 15\text{ V}$, $R_{Goff} = 5.6\ \Omega$, $dv/dt = 3000\text{ V}/\mu\text{s}$ ($T_{vj} = 175\text{ }^\circ\text{C}$)	$T_{vj} = 25\text{ }^\circ\text{C}$	2.31		mJ
			$T_{vj} = 125\text{ }^\circ\text{C}$	3.84		
			$T_{vj} = 175\text{ }^\circ\text{C}$	4.28		
SC data	I_{SC}	$V_{GE} \leq 15\text{ V}$, $V_{CC} = 800\text{ V}$, $V_{CEmax} = V_{CES} - L_{sCE} \cdot di/dt$	$t_p \leq 8\ \mu\text{s}$, $T_{vj} = 150\text{ }^\circ\text{C}$	110		A
			$t_p \leq 7\ \mu\text{s}$, $T_{vj} = 175\text{ }^\circ\text{C}$	100		
Thermal resistance, junction to heat sink	R_{thJH}	per IGBT, $\lambda_{grease} = 1\text{ W}/(\text{m}\cdot\text{K})$		1.09		K/W
Temperature under switching conditions	$T_{vj\ op}$		-40		175	$^\circ\text{C}$

6 Diode, Brake-Chopper

Table 11 **Maximum rated values**

Parameter	Symbol	Note or test condition	Values	Unit	
Repetitive peak reverse voltage	V_{RRM}	$T_{vj} = 25\text{ }^\circ\text{C}$	1200	V	
Continuous DC forward current	I_F		25	A	
Repetitive peak forward current	I_{FRM}	$t_p = 1\text{ ms}$	50	A	
I^2t - value	I^2t	$t_p = 10\text{ ms}$, $V_R = 0\text{ V}$	$T_{vj} = 125\text{ }^\circ\text{C}$	72.5	A^2s
			$T_{vj} = 175\text{ }^\circ\text{C}$	63	

Table 12 **Characteristic values**

Parameter	Symbol	Note or test condition	Values			Unit
			Min.	Typ.	Max.	
Forward voltage	V_F	$I_F = 25\text{ A}$, $V_{GE} = 0\text{ V}$	$T_{vj} = 25\text{ }^\circ\text{C}$	1.83	TBD	V
			$T_{vj} = 125\text{ }^\circ\text{C}$	1.70		
			$T_{vj} = 175\text{ }^\circ\text{C}$	1.63		

(table continues...)

Table 12 (continued) Characteristic values

Parameter	Symbol	Note or test condition	Values			Unit
			Min.	Typ.	Max.	
Peak reverse recovery current	I_{RM}	$V_{CC} = 600\text{ V}, I_F = 25\text{ A},$ $-di_F/dt = 570\text{ A}/\mu\text{s}$ ($T_{vj} = 175\text{ }^\circ\text{C}$)	$T_{vj} = 25\text{ }^\circ\text{C}$	22.2		A
			$T_{vj} = 125\text{ }^\circ\text{C}$	29.2		
			$T_{vj} = 175\text{ }^\circ\text{C}$	33.9		
Recovered charge	Q_r	$V_{CC} = 600\text{ V}, I_F = 25\text{ A},$ $-di_F/dt = 570\text{ A}/\mu\text{s}$ ($T_{vj} = 175\text{ }^\circ\text{C}$)	$T_{vj} = 25\text{ }^\circ\text{C}$	1.63		μC
			$T_{vj} = 125\text{ }^\circ\text{C}$	3.44		
			$T_{vj} = 175\text{ }^\circ\text{C}$	4.59		
Reverse recovery energy	E_{rec}	$V_{CC} = 600\text{ V}, I_F = 25\text{ A},$ $-di_F/dt = 570\text{ A}/\mu\text{s}$ ($T_{vj} = 175\text{ }^\circ\text{C}$)	$T_{vj} = 25\text{ }^\circ\text{C}$	0.38		mJ
			$T_{vj} = 125\text{ }^\circ\text{C}$	1.25		
			$T_{vj} = 175\text{ }^\circ\text{C}$	1.88		
Thermal resistance, junction to heat sink	R_{thJH}	per diode, $\lambda_{grease} = 1\text{ W}/(\text{m}\cdot\text{K})$		2.02		K/W
Temperature under switching conditions	$T_{vj\text{op}}$		-40		175	$^\circ\text{C}$

7 NTC-Thermistor

Table 13 Characteristic values

Parameter	Symbol	Note or test condition	Values			Unit
			Min.	Typ.	Max.	
Rated resistance	R_{25}	$T_{NTC} = 25\text{ }^\circ\text{C}$		5		k Ω
Deviation of R_{100}	$\Delta R/R$	$T_{NTC} = 100\text{ }^\circ\text{C}, R_{100} = 493\text{ }\Omega$	-5		5	%
Power dissipation	P_{25}	$T_{NTC} = 25\text{ }^\circ\text{C}$			20	mW
B-value	$B_{25/50}$	$R_2 = R_{25} \exp[B_{25/50}(1/T_2 - 1/(298,15\text{ K}))]$		3375		K
B-value	$B_{25/80}$	$R_2 = R_{25} \exp[B_{25/80}(1/T_2 - 1/(298,15\text{ K}))]$		3411		K
B-value	$B_{25/100}$	$R_2 = R_{25} \exp[B_{25/100}(1/T_2 - 1/(298,15\text{ K}))]$		3433		K

Note: Specification according to the valid application note.

8 Characteristics diagrams

Output characteristic (typical), IGBT, Inverter

$$I_C = f(V_{CE})$$

$$V_{GE} = 15 \text{ V}$$

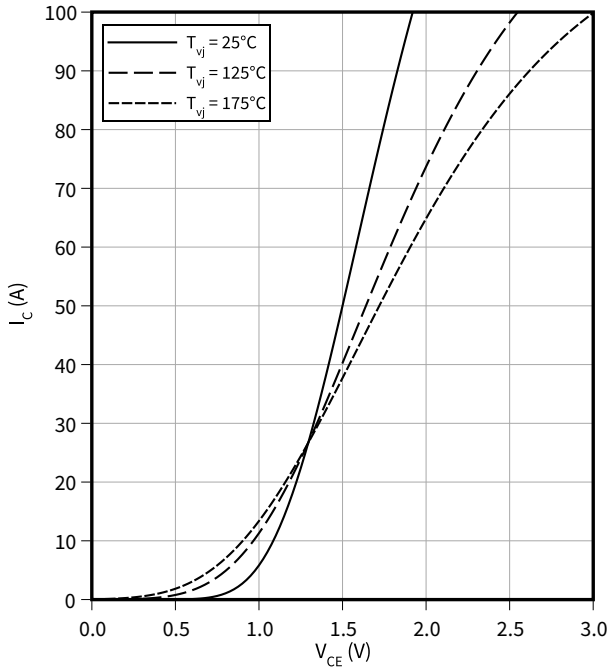

Output characteristic field (typical), IGBT, Inverter

$$I_C = f(V_{CE})$$

$$T_{vj} = 175 \text{ °C}$$

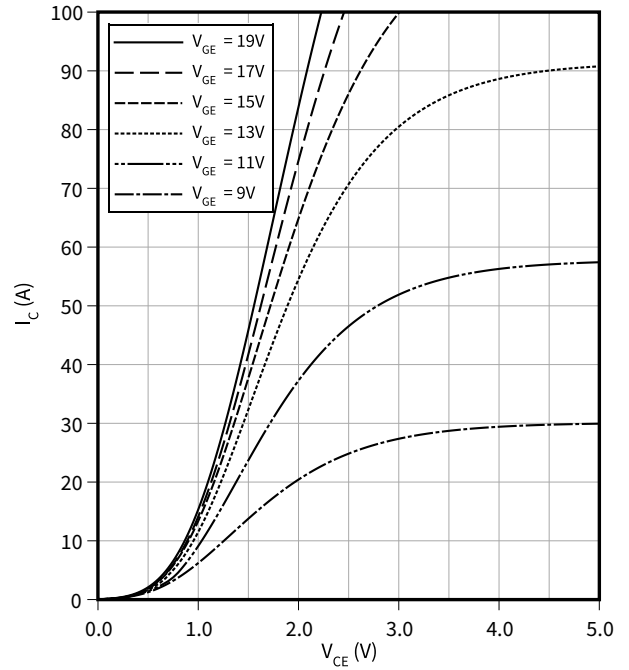

Transfer characteristic (typical), IGBT, Inverter

$$I_C = f(V_{GE})$$

$$V_{CE} = 20 \text{ V}$$

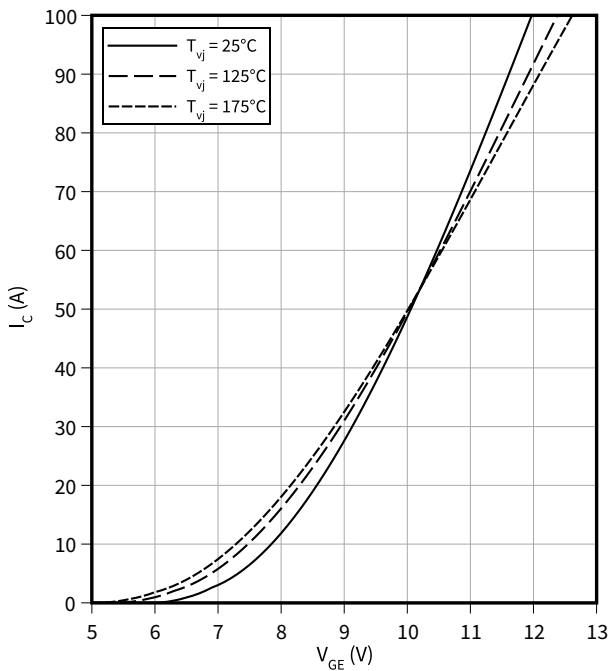

Switching losses (typical), IGBT, Inverter

$$E = f(I_C)$$

$$R_{Goff} = 5.1 \text{ } \Omega, V_{CC} = 600 \text{ V}, V_{GE} = \pm 15 \text{ V}, R_{Gon} = 5.1 \text{ } \Omega$$

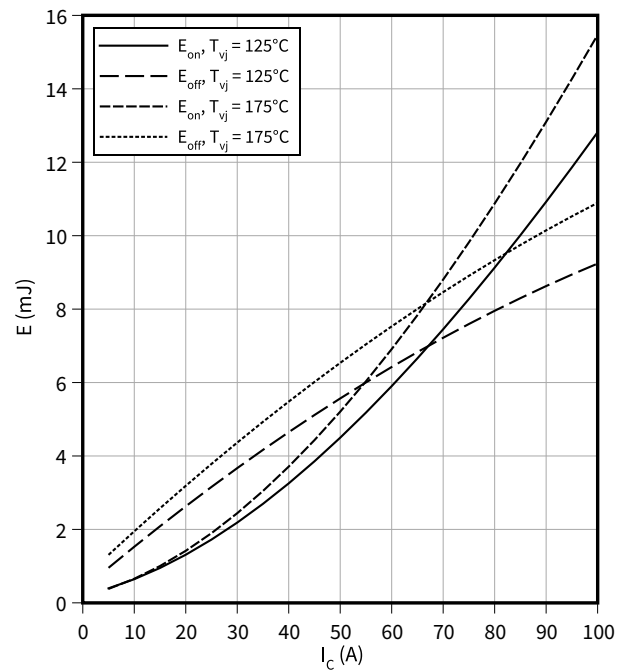

Switching losses (typical), IGBT, Inverter

$E = f(R_G)$

$I_C = 50 \text{ A}, V_{CC} = 600 \text{ V}, V_{GE} = \pm 15 \text{ V}$

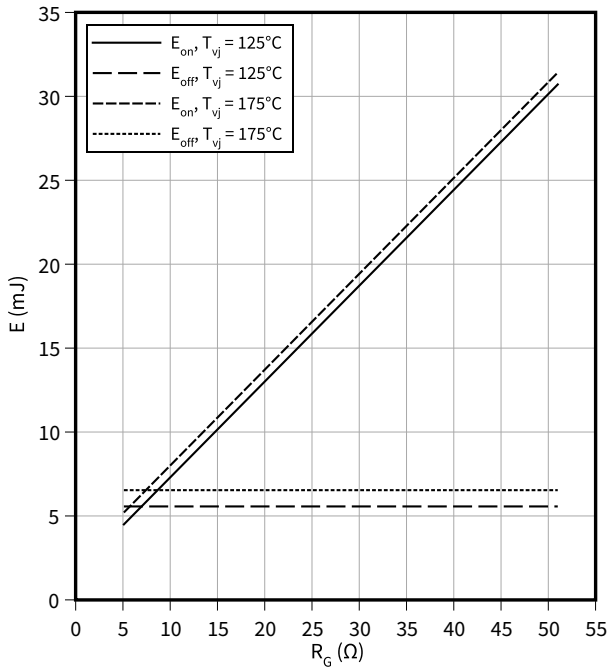

Switching times (typical), IGBT, Inverter

$t = f(I_C)$

$R_{Goff} = 5.1 \Omega, R_{Gon} = 5.1 \Omega, V_{CC} = 600 \text{ V}, V_{GE} = \pm 15 \text{ V}, T_{vj} = 175 \text{ °C}$

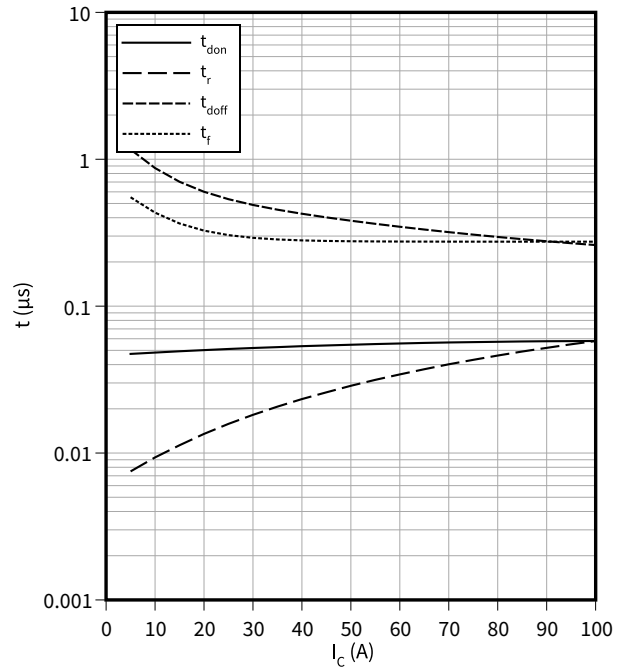

Switching times (typical), IGBT, Inverter

$t = f(R_G)$

$I_C = 50 \text{ A}, V_{CC} = 600 \text{ V}, V_{GE} = \pm 15 \text{ V}, T_{vj} = 175 \text{ °C}$

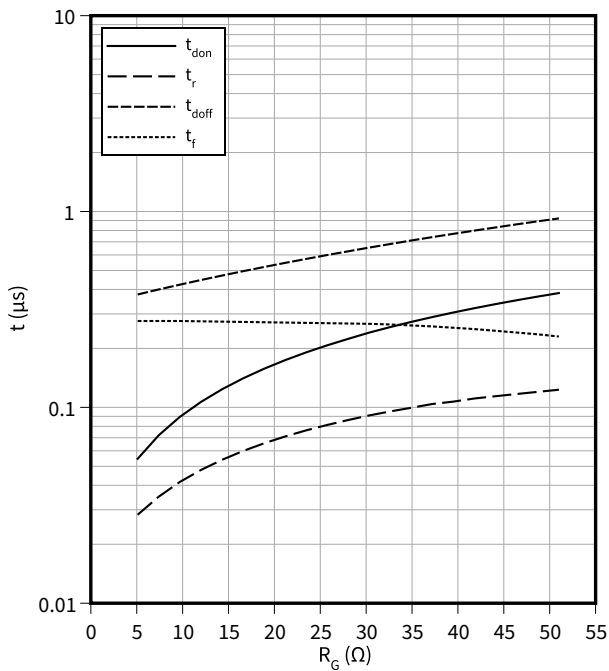

Voltage slope (typical), IGBT, Inverter

$dv/dt = f(R_G)$

$I_C = 50 \text{ A}, V_{CC} = 600 \text{ V}, V_{GE} = \pm 15 \text{ V}, T_{vj} = 25 \text{ °C}$

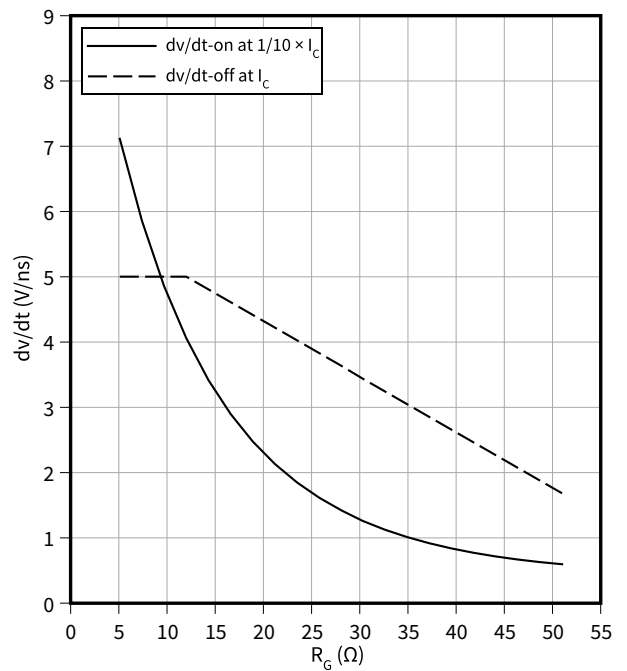

Transient thermal impedance, IGBT, Inverter

$Z_{th} = f(t)$

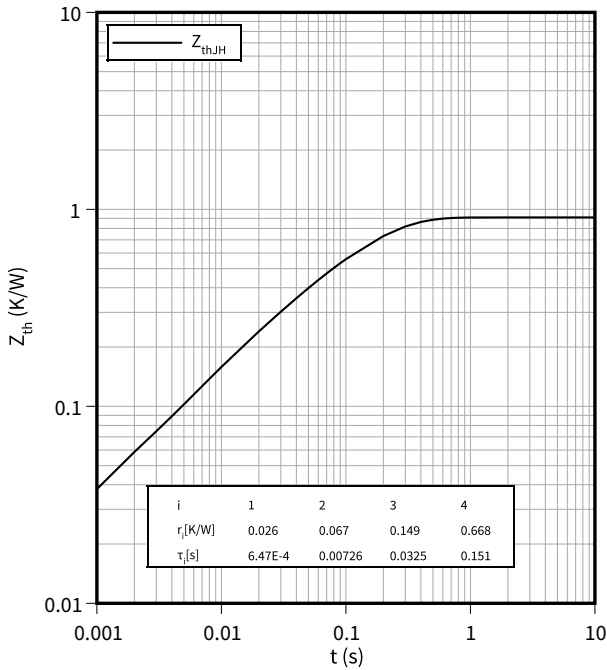

Reverse bias safe operating area (RBSOA), IGBT, Inverter

$I_C = f(V_{CE})$

$R_{Goff} = 5.1 \Omega, V_{GE} = \pm 15 V, T_{vj} = 175 \text{ }^\circ\text{C}$

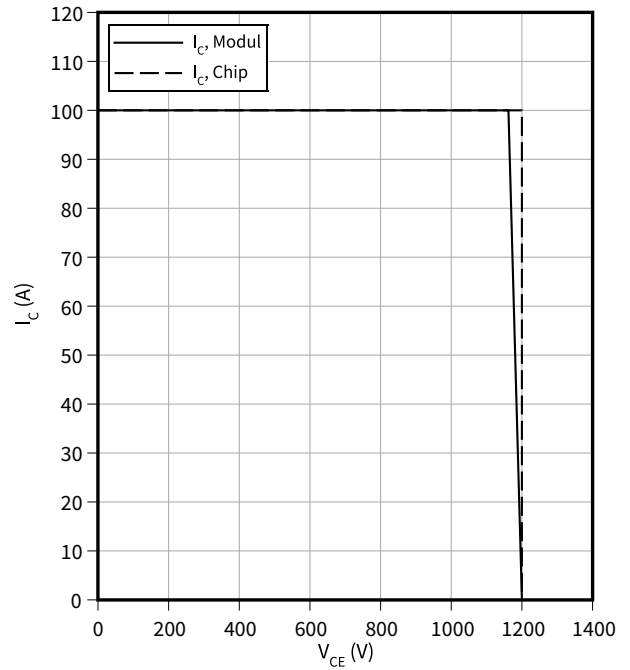

Capacity characteristic (typical), IGBT, Inverter

$C = f(V_{CE})$

$V_{GE} = 0 V, T_{vj} = 25 \text{ }^\circ\text{C}, f = 100 \text{ kHz}$

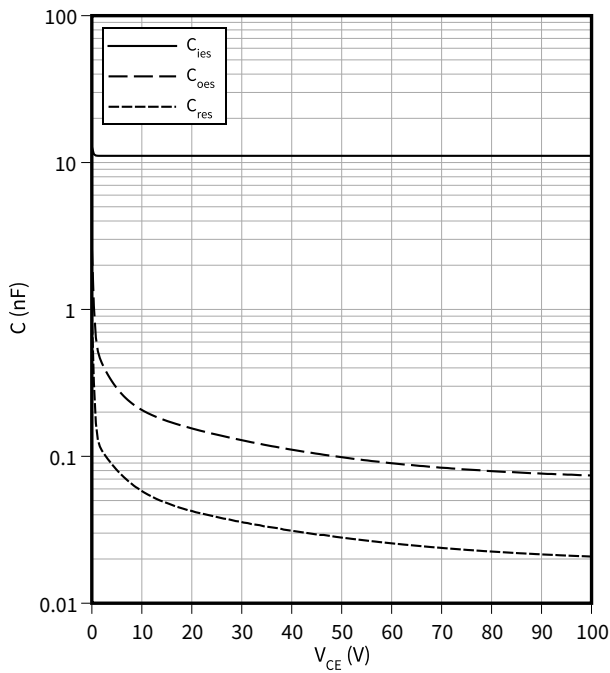

Gate charge characteristic (typical), IGBT, Inverter

$V_{GE} = f(Q_G)$

$I_C = 50 A, T_{vj} = 25 \text{ }^\circ\text{C}$

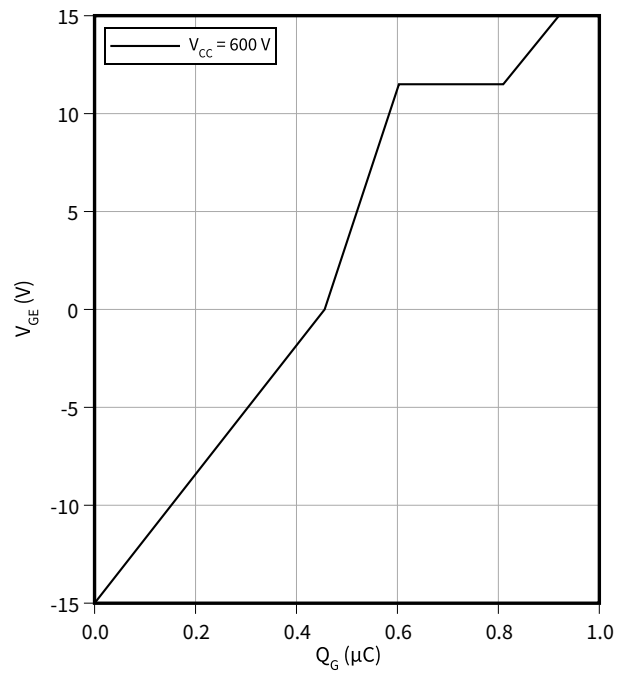

Forward characteristic (typical), Diode, Inverter

$I_F = f(V_F)$

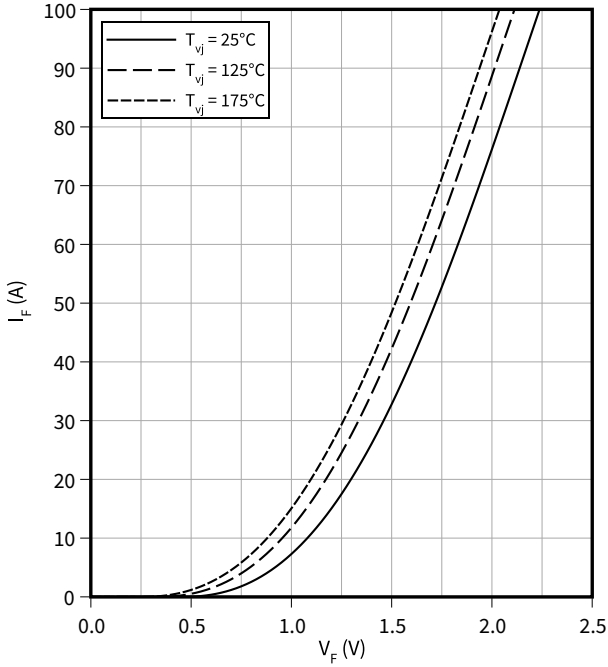

Switching losses (typical), Diode, Inverter

$E_{rec} = f(I_F)$

$R_{Gon} = 5.1 \Omega, V_{CC} = 600 \text{ V}$

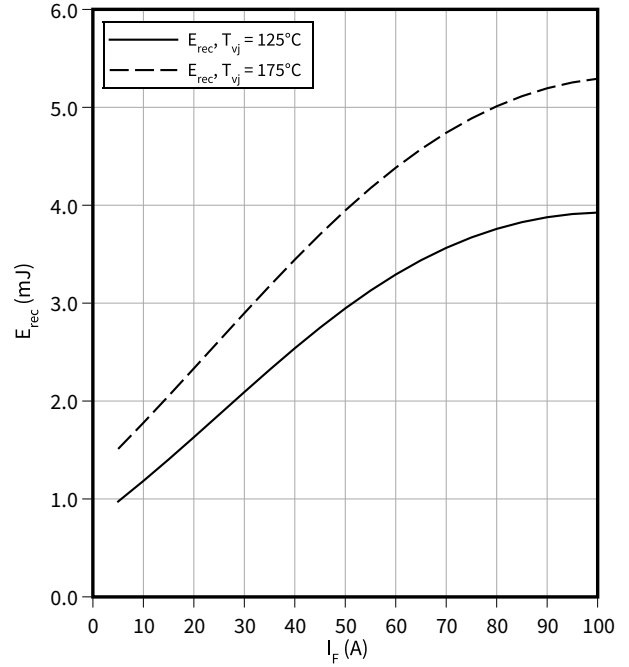

Switching losses (typical), Diode, Inverter

$E_{rec} = f(R_G)$

$I_F = 50 \text{ A}, V_{CC} = 600 \text{ V}$

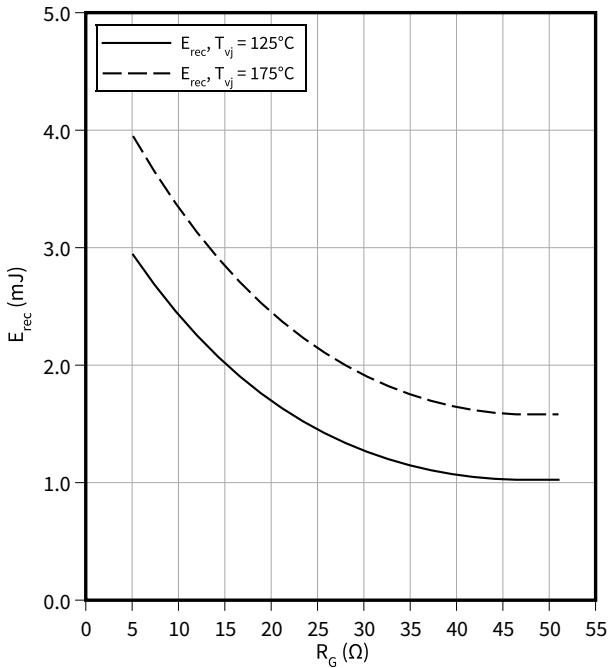

Transient thermal impedance, Diode, Inverter

$Z_{th} = f(t)$

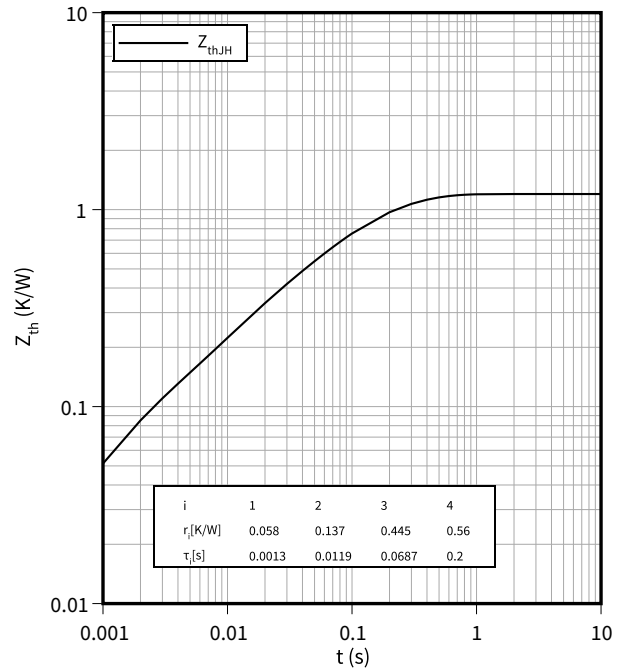

Forward characteristic (typical), Diode, Rectifier

$I_F = f(V_F)$

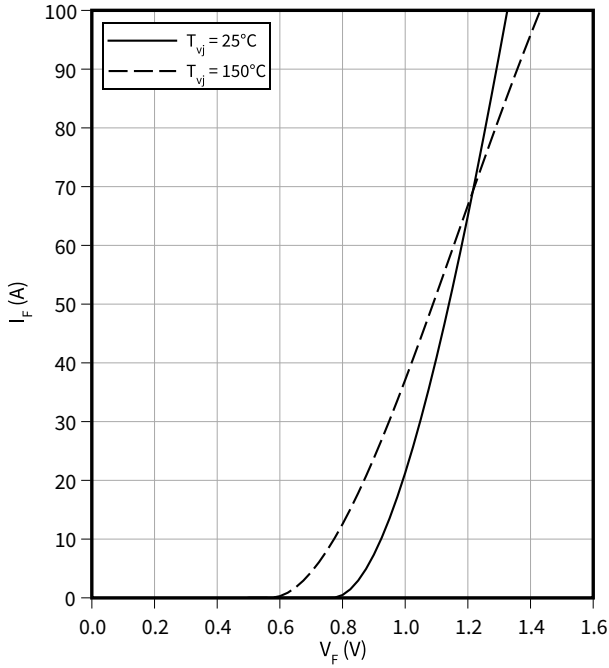

Transient thermal impedance, Diode, Rectifier

$Z_{th} = f(t)$

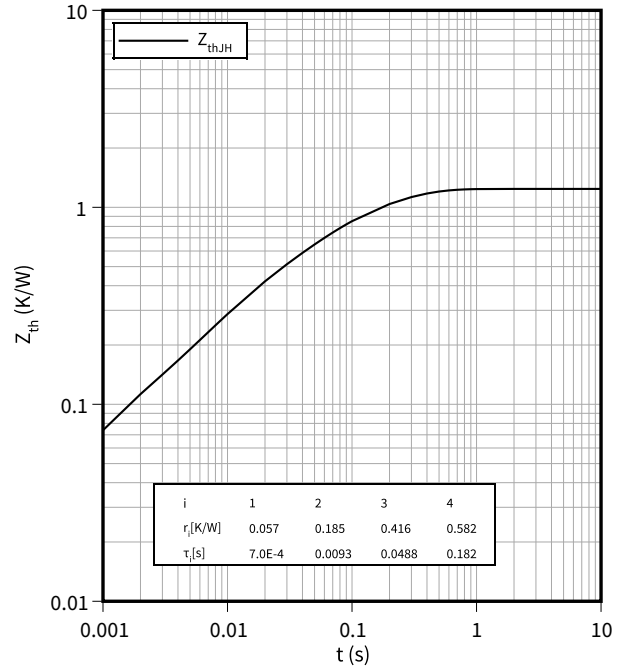

Output characteristic (typical), IGBT, Brake-Chopper

$I_C = f(V_{CE})$

$V_{GE} = 15 \text{ V}$

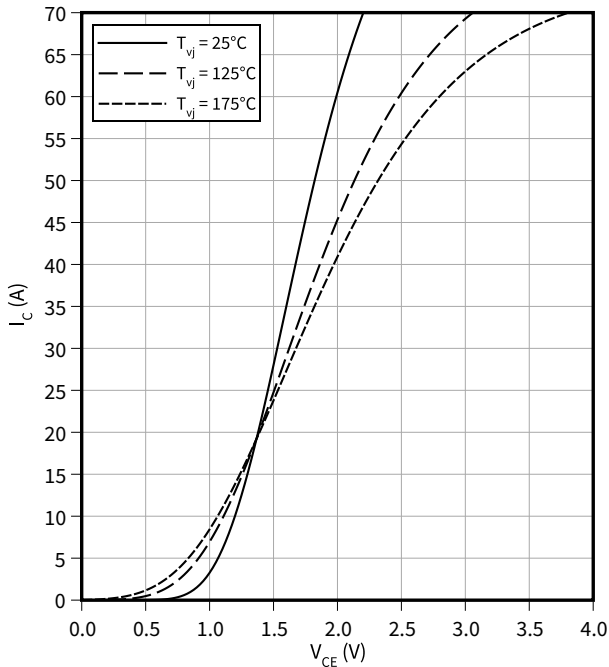

Forward characteristic (typical), Diode, Brake-Chopper

$I_F = f(V_F)$

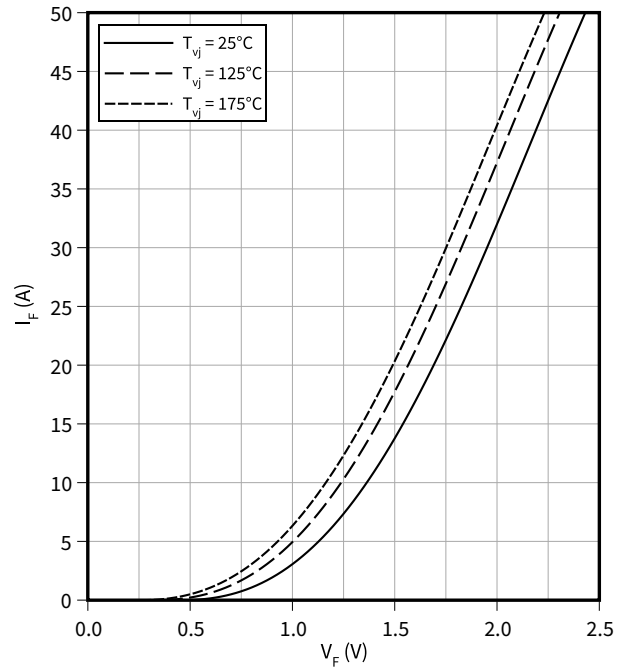

Temperature characteristic (typical), NTC-Thermistor

$$R = f(T_{NTC})$$

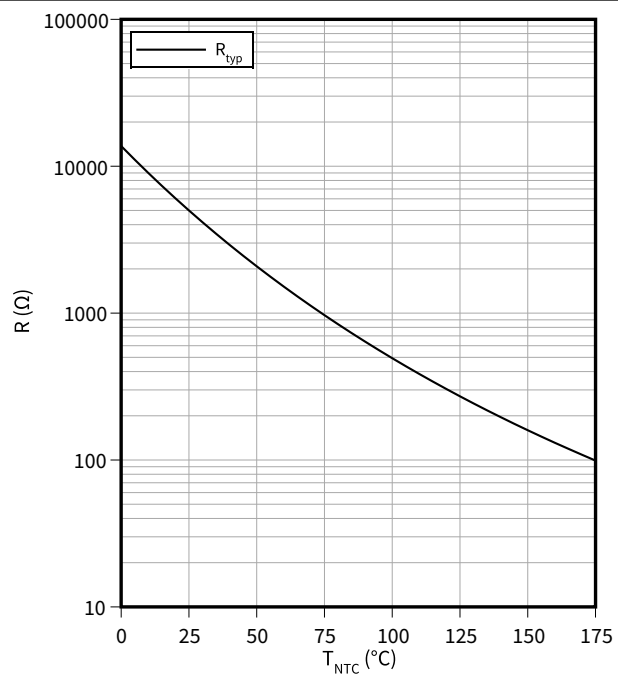

9 Circuit diagram

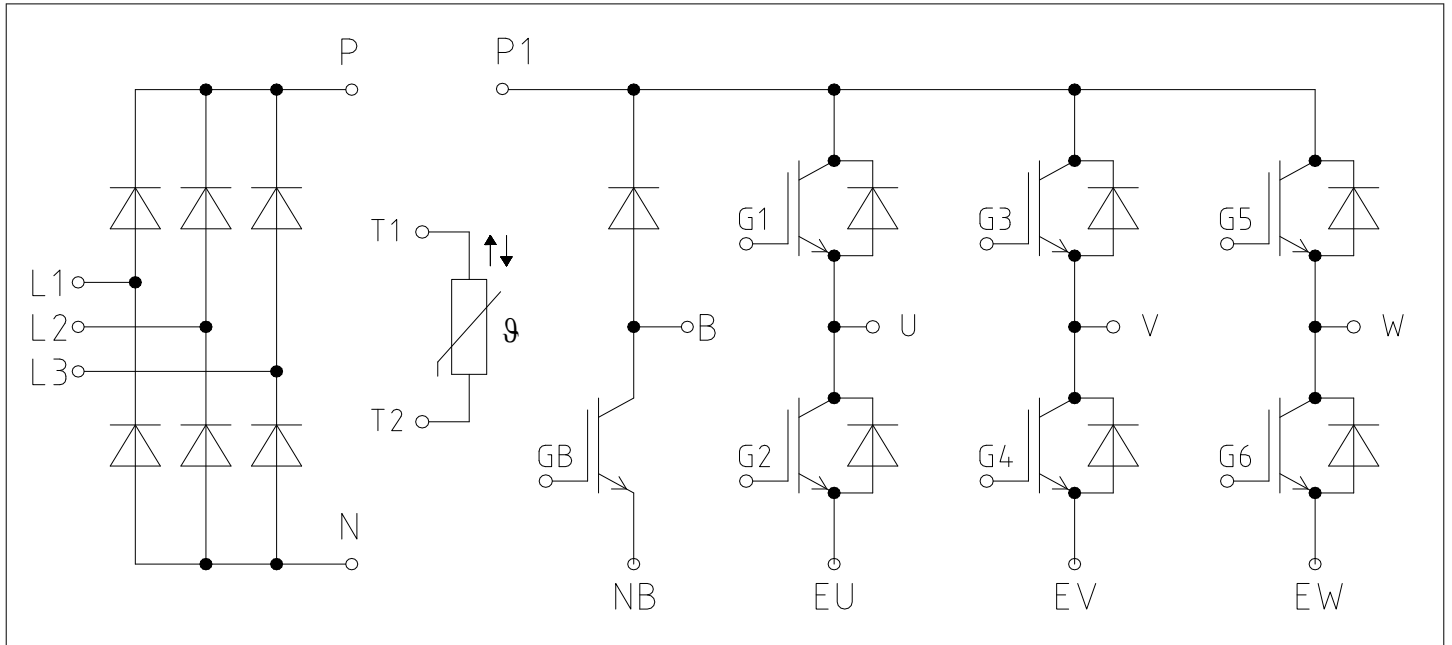

Figure 1

10 Package outlines

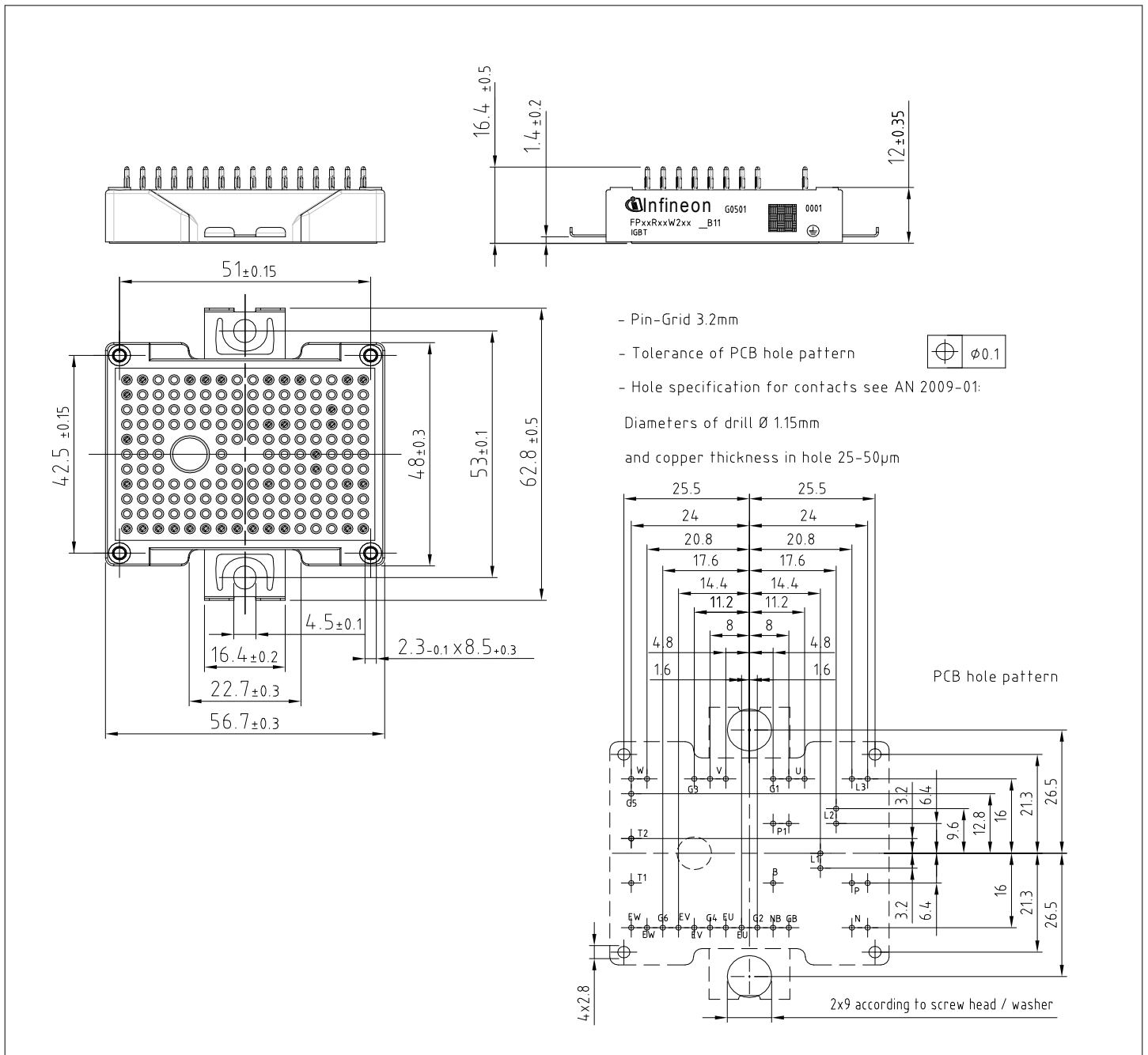

Figure 2

11 Module label code

Module label code			
Code format	Data Matrix	Barcode Code128	
Encoding	ASCII text	Code Set A	
Symbol size	16x16	23 digits	
Standard	IEC24720 and IEC16022	IEC8859-1	
Code content	<i>Content</i> Module serial number Module material number Production order number Date code (production year) Date code (production week)	<i>Digit</i> 1 - 5 6 - 11 12 - 19 20 - 21 22 - 23	<i>Example</i> 71549 142846 55054991 15 30
Example	<div style="display: flex; justify-content: space-around; align-items: center;"> <div style="text-align: center;">  71549142846550549911530 </div> <div style="text-align: center;">  71549142846550549911530 </div> </div>		

Figure 3

Revision history

Document revision	Date of release	Description of changes
V1.0	2018-03-06	Target datasheet
V1.1	2019-09-11	Target datasheet
V2.0	2020-03-13	Preliminary datasheet
n/a	2020-09-01	Datasheet migrated to a new system with a new layout and new revision number schema: target or preliminary datasheet = 0.xy; final datasheet = 1.xy
0.20	2023-02-14	Preliminary datasheet

Trademarks

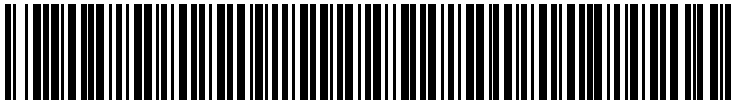
All referenced product or service names and trademarks are the property of their respective owners.

Edition 2023-02-14

Published by

Infineon Technologies AG

81726 Munich, Germany

© 2023 Infineon Technologies AG

All Rights Reserved.

Do you have a question about any aspect of this document?

Email: erratum@infineon.com

Document reference

IFX-AAX991-004

Important notice

The information given in this document shall in no event be regarded as a guarantee of conditions or characteristics ("Beschaffheitsgarantie").

With respect to any examples, hints or any typical values stated herein and/or any information regarding the application of the product, Infineon Technologies hereby disclaims any and all warranties and liabilities of any kind, including without limitation warranties of non-infringement of intellectual property rights of any third party.

In addition, any information given in this document is subject to customer's compliance with its obligations stated in this document and any applicable legal requirements, norms and standards concerning customer's products and any use of the product of Infineon Technologies in customer's applications.

The data contained in this document is exclusively intended for technically trained staff. It is the responsibility of customer's technical departments to evaluate the suitability of the product for the intended application and the completeness of the product information given in this document with respect to such application.

Warnings

Due to technical requirements products may contain dangerous substances. For information on the types in question please contact your nearest Infineon Technologies office.

Except as otherwise explicitly approved by Infineon Technologies in a written document signed by authorized representatives of Infineon Technologies, Infineon Technologies' products may not be used in any applications where a failure of the product or any consequences of the use thereof can reasonably be expected to result in personal injury.

单击下面可查看定价，库存，交付和生命周期等信息

[>>Infineon\(英飞凌\)](#)