

EconoPIM™3 Modul mit Trench/Feldstopp IGBT4 und Emitter Controlled 4 Diode und PressFIT / NTC / TIM  
 EconoPIM™3 module with Trench/Fieldstop IGBT4 and Emitter Controlled 4 diode and PressFIT / NTC / TIM

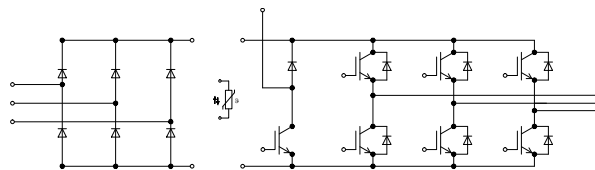

Typical appearance



$V_{CES} = 1200V$   
 $I_{C\ nom} = 150A / I_{CRM} = 300A$

### Potentielle Anwendungen

- Hilfsumrichter
- Motorantriebe
- Servoumrichter

### Potential Applications

- Auxiliary inverters
- Motor drives
- Servo drives

### Elektrische Eigenschaften

- Niedriges  $V_{CEsat}$
- $T_{vj\ op} = 150^{\circ}C$
- $V_{CEsat}$  mit positivem Temperaturkoeffizienten

### Electrical Features

- LOW  $V_{CEsat}$
- $T_{vj\ op} = 150^{\circ}C$
- $V_{CEsat}$  with positive temperature coefficient

### Mechanische Eigenschaften

- Hohe Leistungsdichte
- Integrierter NTC Temperatur Sensor
- Kupferbodenplatte
- PressFIT Verbindungstechnik
- Standardgehäuse
- Thermisches Interface Material bereits aufgetragen

### Mechanical Features

- High power density
- Integrated NTC temperature sensor
- Copper base plate
- PressFIT contact technology
- Standard housing
- Pre-applied Thermal Interface Material

## Module Label Code

Barcode Code 128



DMX - Code



### Content of the Code

Content of the Code	Digit
Module Serial Number	1 - 5
Module Material Number	6 - 11
Production Order Number	12 - 19
Datecode (Production Year)	20 - 21
Datecode (Production Week)	22 - 23

## IGBT, Wechselrichter / IGBT, Inverter

### Höchstzulässige Werte / Maximum Rated Values

Kollektor-Emitter-Sperrspannung Collector-emitter voltage	$T_{vj} = 25^{\circ}\text{C}$	$V_{CES}$	1200	V
Kollektor-Dauergleichstrom Continuous DC collector current	$T_H = 75^{\circ}\text{C}, T_{vj\text{ max}} = 175^{\circ}\text{C}$	$I_{C\text{ nom}}$	150	A
Periodischer Kollektor-Spitzenstrom Repetitive peak collector current	$t_P = 1\text{ ms}$	$I_{CRM}$	300	A
Gate-Emitter-Spitzenspannung Gate-emitter peak voltage		$V_{GES}$	+/-20	V

### Charakteristische Werte / Characteristic Values

			min.	typ.	max.		
Kollektor-Emitter-Sättigungsspannung Collector-emitter saturation voltage	$I_C = 150\text{ A}, V_{GE} = 15\text{ V}$ $I_C = 150\text{ A}, V_{GE} = 15\text{ V}$ $I_C = 150\text{ A}, V_{GE} = 15\text{ V}$	$T_{vj} = 25^{\circ}\text{C}$ $T_{vj} = 125^{\circ}\text{C}$ $T_{vj} = 150^{\circ}\text{C}$	$V_{CE\text{ sat}}$	1,75 2,05 2,10	2,10	V V V	
Gate-Schwellenspannung Gate threshold voltage	$I_C = 5,70\text{ mA}, V_{CE} = V_{GE}, T_{vj} = 25^{\circ}\text{C}$		$V_{GEth}$	5,25	5,80	6,35	V
Gateladung Gate charge	$V_{GE} = -15\text{ V} \dots +15\text{ V}$		$Q_G$	1,20			$\mu\text{C}$
Interner Gatewiderstand Internal gate resistor	$T_{vj} = 25^{\circ}\text{C}$		$R_{Gint}$	5,0			$\Omega$
Eingangskapazität Input capacitance	$f = 1\text{ MHz}, T_{vj} = 25^{\circ}\text{C}, V_{CE} = 25\text{ V}, V_{GE} = 0\text{ V}$		$C_{ies}$	9,35			nF
Rückwirkungskapazität Reverse transfer capacitance	$f = 1\text{ MHz}, T_{vj} = 25^{\circ}\text{C}, V_{CE} = 25\text{ V}, V_{GE} = 0\text{ V}$		$C_{res}$	0,41			nF
Kollektor-Emitter-Reststrom Collector-emitter cut-off current	$V_{CE} = 1200\text{ V}, V_{GE} = 0\text{ V}, T_{vj} = 25^{\circ}\text{C}$		$I_{CES}$			1,0	mA
Gate-Emitter-Reststrom Gate-emitter leakage current	$V_{CE} = 0\text{ V}, V_{GE} = 20\text{ V}, T_{vj} = 25^{\circ}\text{C}$		$I_{GES}$			100	nA
Einschaltverzögerungszeit, induktive Last Turn-on delay time, inductive load	$I_C = 150\text{ A}, V_{CE} = 600\text{ V}$ $V_{GE} = \pm 15\text{ V}$ $R_{Gon} = 6,8\ \Omega$	$T_{vj} = 25^{\circ}\text{C}$ $T_{vj} = 125^{\circ}\text{C}$ $T_{vj} = 150^{\circ}\text{C}$	$t_{don}$	0,16 0,19 0,19			$\mu\text{s}$ $\mu\text{s}$ $\mu\text{s}$
Anstiegszeit, induktive Last Rise time, inductive load	$I_C = 150\text{ A}, V_{CE} = 600\text{ V}$ $V_{GE} = \pm 15\text{ V}$ $R_{Gon} = 6,8\ \Omega$	$T_{vj} = 25^{\circ}\text{C}$ $T_{vj} = 125^{\circ}\text{C}$ $T_{vj} = 150^{\circ}\text{C}$	$t_r$	0,07 0,08 0,08			$\mu\text{s}$ $\mu\text{s}$ $\mu\text{s}$
Abschaltverzögerungszeit, induktive Last Turn-off delay time, inductive load	$I_C = 150\text{ A}, V_{CE} = 600\text{ V}$ $V_{GE} = \pm 15\text{ V}$ $R_{Goff} = 6,8\ \Omega$	$T_{vj} = 25^{\circ}\text{C}$ $T_{vj} = 125^{\circ}\text{C}$ $T_{vj} = 150^{\circ}\text{C}$	$t_{doff}$	0,42 0,48 0,53			$\mu\text{s}$ $\mu\text{s}$ $\mu\text{s}$
Fallzeit, induktive Last Fall time, inductive load	$I_C = 150\text{ A}, V_{CE} = 600\text{ V}$ $V_{GE} = \pm 15\text{ V}$ $R_{Goff} = 6,8\ \Omega$	$T_{vj} = 25^{\circ}\text{C}$ $T_{vj} = 125^{\circ}\text{C}$ $T_{vj} = 150^{\circ}\text{C}$	$t_f$	0,10 0,19 0,22			$\mu\text{s}$ $\mu\text{s}$ $\mu\text{s}$
Einschaltverlustenergie pro Puls Turn-on energy loss per pulse	$I_C = 150\text{ A}, V_{CE} = 600\text{ V}, L_S = 35\text{ nH}$ $V_{GE} = \pm 15\text{ V}, di/dt = 1600\text{ A}/\mu\text{s} (T_{vj} = 150^{\circ}\text{C})$ $R_{Gon} = 6,8\ \Omega$	$T_{vj} = 25^{\circ}\text{C}$ $T_{vj} = 125^{\circ}\text{C}$ $T_{vj} = 150^{\circ}\text{C}$	$E_{on}$	22,0 28,5 30,5			mJ mJ mJ
Abschaltverlustenergie pro Puls Turn-off energy loss per pulse	$I_C = 150\text{ A}, V_{CE} = 600\text{ V}, L_S = 35\text{ nH}$ $V_{GE} = \pm 15\text{ V}, du/dt = 3600\text{ V}/\mu\text{s} (T_{vj} = 150^{\circ}\text{C})$ $R_{Goff} = 6,8\ \Omega$	$T_{vj} = 25^{\circ}\text{C}$ $T_{vj} = 125^{\circ}\text{C}$ $T_{vj} = 150^{\circ}\text{C}$	$E_{off}$	9,80 15,0 17,0			mJ mJ mJ
Kurzschlußverhalten SC data	$V_{GE} \leq 15\text{ V}, V_{CC} = 800\text{ V}$ $V_{CEmax} = V_{CES} - L_{SCE} \cdot di/dt$ $t_P \leq 10\ \mu\text{s}, T_{vj} = 150^{\circ}\text{C}$		$I_{SC}$	540			A
Wärmewiderstand, Chip bis Kühlkörper Thermal resistance, junction to heatsink	pro IGBT / per IGBT valid with IFX pre-applied thermal interface material		$R_{thJH}$			0,250	K/W
Temperatur im Schaltbetrieb Temperature under switching conditions			$T_{vj\text{ op}}$	-40		150	$^{\circ}\text{C}$

## Diode, Wechselrichter / Diode, Inverter

### Höchstzulässige Werte / Maximum Rated Values

Periodische Spitzensperrspannung Repetitive peak reverse voltage	$T_{vj} = 25^{\circ}\text{C}$	$V_{RRM}$	1200	V
Dauergleichstrom Continuous DC forward current		$I_F$	150	A
Periodischer Spitzenstrom Repetitive peak forward current	$t_p = 1 \text{ ms}$	$I_{FRM}$	300	A
Grenzlastintegral $I^2t$ - value	$V_R = 0 \text{ V}, t_p = 10 \text{ ms}, T_{vj} = 125^{\circ}\text{C}$ $V_R = 0 \text{ V}, t_p = 10 \text{ ms}, T_{vj} = 150^{\circ}\text{C}$	$I^2t$	3050 2950	$\text{A}^2\text{s}$ $\text{A}^2\text{s}$

### Charakteristische Werte / Characteristic Values

			min.	typ.	max.	
Durchlassspannung Forward voltage	$I_F = 150 \text{ A}, V_{GE} = 0 \text{ V}$ $I_F = 150 \text{ A}, V_{GE} = 0 \text{ V}$ $I_F = 150 \text{ A}, V_{GE} = 0 \text{ V}$	$T_{vj} = 25^{\circ}\text{C}$ $T_{vj} = 125^{\circ}\text{C}$ $T_{vj} = 150^{\circ}\text{C}$	$V_F$	1,70 1,65 1,65	2,15	V V V
Rückstromspitze Peak reverse recovery current	$I_F = 150 \text{ A}, -di_F/dt = 1600 \text{ A}/\mu\text{s} (T_{vj}=150^{\circ}\text{C})$ $V_R = 600 \text{ V}$ $V_{GE} = -15 \text{ V}$	$T_{vj} = 25^{\circ}\text{C}$ $T_{vj} = 125^{\circ}\text{C}$ $T_{vj} = 150^{\circ}\text{C}$	$I_{RM}$	57,0 73,0 78,0		A A A
Sperrverzögerungsladung Recovered charge	$I_F = 150 \text{ A}, -di_F/dt = 1600 \text{ A}/\mu\text{s} (T_{vj}=150^{\circ}\text{C})$ $V_R = 600 \text{ V}$ $V_{GE} = -15 \text{ V}$	$T_{vj} = 25^{\circ}\text{C}$ $T_{vj} = 125^{\circ}\text{C}$ $T_{vj} = 150^{\circ}\text{C}$	$Q_r$	9,80 19,5 22,0		$\mu\text{C}$ $\mu\text{C}$ $\mu\text{C}$
Abschaltenergie pro Puls Reverse recovery energy	$I_F = 150 \text{ A}, -di_F/dt = 1600 \text{ A}/\mu\text{s} (T_{vj}=150^{\circ}\text{C})$ $V_R = 600 \text{ V}$ $V_{GE} = -15 \text{ V}$	$T_{vj} = 25^{\circ}\text{C}$ $T_{vj} = 125^{\circ}\text{C}$ $T_{vj} = 150^{\circ}\text{C}$	$E_{rec}$	2,60 5,20 6,20		mJ mJ mJ
Wärmewiderstand, Chip bis Kühlkörper Thermal resistance, junction to heatsink	pro Diode / per diode valid with IFX pre-applied thermal interface material		$R_{thJH}$		0,407	K/W
Temperatur im Schaltbetrieb Temperature under switching conditions			$T_{vj op}$	-40	150	$^{\circ}\text{C}$

## Diode, Gleichrichter / Diode, Rectifier

### Höchstzulässige Werte / Maximum Rated Values

Periodische Spitzensperrspannung Repetitive peak reverse voltage	$T_{vj} = 25^{\circ}\text{C}$	$V_{RRM}$	1600	V
Durchlassstrom Grenzeffektivwert pro Chip Maximum RMS forward current per chip	$T_H = 100^{\circ}\text{C}$	$I_{FRMSM}$	150	A
Gleichrichter Ausgang Grenzeffektivstrom Maximum RMS current at rectifier output	$T_H = 100^{\circ}\text{C}$	$I_{RMSM}$	150	A
Stoßstrom Grenzwert Surge forward current	$t_p = 10 \text{ ms}, T_{vj} = 25^{\circ}\text{C}$ $t_p = 10 \text{ ms}, T_{vj} = 150^{\circ}\text{C}$	$I_{FSM}$	1600 1400	A A
Grenzlastintegral $I^2t$ - value	$t_p = 10 \text{ ms}, T_{vj} = 25^{\circ}\text{C}$ $t_p = 10 \text{ ms}, T_{vj} = 150^{\circ}\text{C}$	$I^2t$	13000 9800	$\text{A}^2\text{s}$ $\text{A}^2\text{s}$

### Charakteristische Werte / Characteristic Values

			min.	typ.	max.	
Durchlassspannung Forward voltage	$T_{vj} = 150^{\circ}\text{C}, I_F = 150 \text{ A}$	$V_F$		1,00		V
Sperrstrom Reverse current	$T_{vj} = 150^{\circ}\text{C}, V_R = 1600 \text{ V}$	$I_R$		1,00		mA
Wärmewiderstand, Chip bis Kühlkörper Thermal resistance, junction to heatsink	pro Diode / per diode valid with IFX pre-applied thermal interface material		$R_{thJH}$		0,356	K/W
Temperatur im Schaltbetrieb Temperature under switching conditions			$T_{vj op}$	-40	150	$^{\circ}\text{C}$

## IGBT, Brems-Chopper / IGBT, Brake-Chopper Höchstzulässige Werte / Maximum Rated Values

Kollektor-Emitter-Sperrspannung Collector-emitter voltage	$T_{vj} = 25^{\circ}\text{C}$	$V_{CES}$	1200	V
Kollektor-Dauergleichstrom Continuous DC collector current	$T_H = 90^{\circ}\text{C}, T_{vj\text{ max}} = 175^{\circ}\text{C}$	$I_{C\text{ nom}}$	100	A
Periodischer Kollektor-Spitzenstrom Repetitive peak collector current	$t_P = 1\text{ ms}$	$I_{CRM}$	200	A
Gate-Emitter-Spitzenspannung Gate-emitter peak voltage		$V_{GES}$	+/-20	V

## Charakteristische Werte / Characteristic Values

			min.	typ.	max.		
Kollektor-Emitter-Sättigungsspannung Collector-emitter saturation voltage	$I_C = 100\text{ A}, V_{GE} = 15\text{ V}$	$T_{vj} = 25^{\circ}\text{C}$	$V_{CE\text{ sat}}$	1,75	2,10	V	
	$I_C = 100\text{ A}, V_{GE} = 15\text{ V}$	$T_{vj} = 125^{\circ}\text{C}$		2,05		V	
	$I_C = 100\text{ A}, V_{GE} = 15\text{ V}$	$T_{vj} = 150^{\circ}\text{C}$		2,10		V	
Gate-Schwellenspannung Gate threshold voltage	$I_C = 3,80\text{ mA}, V_{CE} = V_{GE}, T_{vj} = 25^{\circ}\text{C}$		$V_{GEth}$	5,25	5,80	6,35	V
Gateladung Gate charge	$V_{GE} = -15\text{ V} \dots +15\text{ V}$		$Q_G$	0,80			$\mu\text{C}$
Interner Gatewiderstand Internal gate resistor	$T_{vj} = 25^{\circ}\text{C}$		$R_{Gint}$	7,5			$\Omega$
Eingangskapazität Input capacitance	$f = 1\text{ MHz}, T_{vj} = 25^{\circ}\text{C}, V_{CE} = 25\text{ V}, V_{GE} = 0\text{ V}$		$C_{ies}$	6,30			nF
Rückwirkungskapazität Reverse transfer capacitance	$f = 1\text{ MHz}, T_{vj} = 25^{\circ}\text{C}, V_{CE} = 25\text{ V}, V_{GE} = 0\text{ V}$		$C_{res}$	0,27			nF
Kollektor-Emitter-Reststrom Collector-emitter cut-off current	$V_{CE} = 1200\text{ V}, V_{GE} = 0\text{ V}, T_{vj} = 25^{\circ}\text{C}$		$I_{CES}$			1,0	mA
Gate-Emitter-Reststrom Gate-emitter leakage current	$V_{CE} = 0\text{ V}, V_{GE} = 20\text{ V}, T_{vj} = 25^{\circ}\text{C}$		$I_{GES}$			100	nA
Einschaltverzögerungszeit, induktive Last Turn-on delay time, inductive load	$I_C = 100\text{ A}, V_{CE} = 600\text{ V}$ $V_{GE} = \pm 15\text{ V}$ $R_{Gon} = 1,6\ \Omega$	$T_{vj} = 25^{\circ}\text{C}$	$t_{don}$	0,15		$\mu\text{s}$	
		$T_{vj} = 125^{\circ}\text{C}$		0,16		$\mu\text{s}$	
		$T_{vj} = 150^{\circ}\text{C}$		0,16		$\mu\text{s}$	
Anstiegszeit, induktive Last Rise time, inductive load	$I_C = 100\text{ A}, V_{CE} = 600\text{ V}$ $V_{GE} = \pm 15\text{ V}$ $R_{Gon} = 1,6\ \Omega$	$T_{vj} = 25^{\circ}\text{C}$	$t_r$	0,03		$\mu\text{s}$	
		$T_{vj} = 125^{\circ}\text{C}$		0,04		$\mu\text{s}$	
		$T_{vj} = 150^{\circ}\text{C}$		0,04		$\mu\text{s}$	
Abschaltverzögerungszeit, induktive Last Turn-off delay time, inductive load	$I_C = 100\text{ A}, V_{CE} = 600\text{ V}$ $V_{GE} = \pm 15\text{ V}$ $R_{Goff} = 1,6\ \Omega$	$T_{vj} = 25^{\circ}\text{C}$	$t_{doff}$	0,31		$\mu\text{s}$	
		$T_{vj} = 125^{\circ}\text{C}$		0,35		$\mu\text{s}$	
		$T_{vj} = 150^{\circ}\text{C}$		0,37		$\mu\text{s}$	
Fallzeit, induktive Last Fall time, inductive load	$I_C = 100\text{ A}, V_{CE} = 600\text{ V}$ $V_{GE} = \pm 15\text{ V}$ $R_{Goff} = 1,6\ \Omega$	$T_{vj} = 25^{\circ}\text{C}$	$t_f$	0,10		$\mu\text{s}$	
		$T_{vj} = 125^{\circ}\text{C}$		0,16		$\mu\text{s}$	
		$T_{vj} = 150^{\circ}\text{C}$		0,21		$\mu\text{s}$	
Einschaltverlustenergie pro Puls Turn-on energy loss per pulse	$I_C = 100\text{ A}, V_{CE} = 600\text{ V}, L_S = 35\text{ nH}$ $V_{GE} = \pm 15\text{ V}, di/dt = 2300\text{ A}/\mu\text{s} (T_{vj} = 150^{\circ}\text{C})$ $R_{Gon} = 1,6\ \Omega$	$T_{vj} = 25^{\circ}\text{C}$	$E_{on}$	6,10		mJ	
		$T_{vj} = 125^{\circ}\text{C}$		9,00		mJ	
		$T_{vj} = 150^{\circ}\text{C}$		9,70		mJ	
Abschaltverlustenergie pro Puls Turn-off energy loss per pulse	$I_C = 100\text{ A}, V_{CE} = 600\text{ V}, L_S = 35\text{ nH}$ $V_{GE} = \pm 15\text{ V}, du/dt = 3700\text{ V}/\mu\text{s} (T_{vj} = 150^{\circ}\text{C})$ $R_{Goff} = 1,6\ \Omega$	$T_{vj} = 25^{\circ}\text{C}$	$E_{off}$	6,10		mJ	
		$T_{vj} = 125^{\circ}\text{C}$		9,20		mJ	
		$T_{vj} = 150^{\circ}\text{C}$		10,0		mJ	
Kurzschlußverhalten SC data	$V_{GE} \leq 15\text{ V}, V_{CC} = 800\text{ V}$ $V_{CEmax} = V_{CES} - L_{SCE} \cdot di/dt$	$t_P \leq 10\ \mu\text{s}, T_{vj} = 150^{\circ}\text{C}$	$I_{SC}$	360		A	
Wärmewiderstand, Chip bis Kühlkörper Thermal resistance, junction to heatsink	pro IGBT / per IGBT valid with IFX pre-applied thermal interface material		$R_{thJH}$		0,308	K/W	
Temperatur im Schaltbetrieb Temperature under switching conditions			$T_{vj\text{ op}}$	-40	150	$^{\circ}\text{C}$	

## Diode, Brems-Chopper / Diode, Brake-Chopper Höchstzulässige Werte / Maximum Rated Values

Periodische Spitzensperrensorgung Repetitive peak reverse voltage	$T_{vj} = 25^{\circ}\text{C}$	$V_{RRM}$	1200	V
Dauergleichstrom Continuous DC forward current		$I_F$	50	A
Periodischer Spitzenstrom Repetitive peak forward current	$t_p = 1\text{ ms}$	$I_{FRM}$	100	A
Grenzlastintegral $I^2t$ - value	$V_R = 0\text{ V}, t_p = 10\text{ ms}, T_{vj} = 125^{\circ}\text{C}$	$I^2t$	560	$\text{A}^2\text{s}$
	$V_R = 0\text{ V}, t_p = 10\text{ ms}, T_{vj} = 150^{\circ}\text{C}$		475	$\text{A}^2\text{s}$

## Charakteristische Werte / Characteristic Values

			min.	typ.	max.	
Durchlassspannung Forward voltage	$I_F = 50\text{ A}, V_{GE} = 0\text{ V}$	$T_{vj} = 25^{\circ}\text{C}$	$V_F$	1,70	2,15	V
	$I_F = 50\text{ A}, V_{GE} = 0\text{ V}$	$T_{vj} = 125^{\circ}\text{C}$		1,65		V
	$I_F = 50\text{ A}, V_{GE} = 0\text{ V}$	$T_{vj} = 150^{\circ}\text{C}$		1,65		V
Rückstromspitze Peak reverse recovery current	$I_F = 50\text{ A}, -di_F/dt = 2300\text{ A}/\mu\text{s} (T_{vj}=150^{\circ}\text{C})$ $V_R = 600\text{ V}$ $V_{GE} = 15\text{ V}$	$T_{vj} = 25^{\circ}\text{C}$	$I_{RM}$	76,0		A
		$T_{vj} = 125^{\circ}\text{C}$		77,0		A
		$T_{vj} = 150^{\circ}\text{C}$		77,0		A
Sperrverzögerungsladung Recovered charge	$I_F = 50\text{ A}, -di_F/dt = 2300\text{ A}/\mu\text{s} (T_{vj}=150^{\circ}\text{C})$ $V_R = 600\text{ V}$ $V_{GE} = 15\text{ V}$	$T_{vj} = 25^{\circ}\text{C}$	$Q_r$	5,70		$\mu\text{C}$
		$T_{vj} = 125^{\circ}\text{C}$		9,40		$\mu\text{C}$
		$T_{vj} = 150^{\circ}\text{C}$		10,5		$\mu\text{C}$
Abschaltenergie pro Puls Reverse recovery energy	$I_F = 50\text{ A}, -di_F/dt = 2300\text{ A}/\mu\text{s} (T_{vj}=150^{\circ}\text{C})$ $V_R = 600\text{ V}$ $V_{GE} = 15\text{ V}$	$T_{vj} = 25^{\circ}\text{C}$	$E_{rec}$	2,00		mJ
		$T_{vj} = 125^{\circ}\text{C}$		3,50		mJ
		$T_{vj} = 150^{\circ}\text{C}$		3,80		mJ
Wärmewiderstand, Chip bis Kühlkörper Thermal resistance, junction to heatsink	pro Diode / per diode valid with IFX pre-applied thermal interface material	$R_{thJH}$			0,810	K/W
Temperatur im Schaltbetrieb Temperature under switching conditions		$T_{vj\text{ op}}$	-40		150	$^{\circ}\text{C}$

## NTC-Widerstand / NTC-Thermistor

### Charakteristische Werte / Characteristic Values

			min.	typ.	max.	
Nennwiderstand Rated resistance	$T_{NTC} = 25^{\circ}\text{C}$	$R_{25}$		5,00		k $\Omega$
Abweichung von R100 Deviation of R100	$T_{NTC} = 100^{\circ}\text{C}, R_{100} = 493\ \Omega$	$\Delta R/R$	-5		5	%
Verlustleistung Power dissipation	$T_{NTC} = 25^{\circ}\text{C}$	$P_{25}$			20,0	mW
B-Wert B-value	$R_2 = R_{25} \exp [B_{25/50}(1/T_2 - 1/(298,15\text{ K}))]$	$B_{25/50}$		3375		K
B-Wert B-value	$R_2 = R_{25} \exp [B_{25/80}(1/T_2 - 1/(298,15\text{ K}))]$	$B_{25/80}$		3411		K
B-Wert B-value	$R_2 = R_{25} \exp [B_{25/100}(1/T_2 - 1/(298,15\text{ K}))]$	$B_{25/100}$		3433		K

Angaben gemäß gültiger Application Note.  
Specification according to the valid application note.

## Modul / Module

Isolations-Prüfspannung Isolation test voltage	RMS, f = 50 Hz, t = 1 min.	V <sub>ISOL</sub>	2,5		kV
Material Modulgrundplatte Material of module baseplate			Cu		
Innere Isolation Internal isolation	Basisisolation (Schutzklasse 1, EN61140) basic insulation (class 1, IEC 61140)		Al <sub>2</sub> O <sub>3</sub>		
Kriechstrecke Creepage distance	Kontakt - Kühlkörper / terminal to heatsink Kontakt - Kontakt / terminal to terminal		10,0 5,0		mm
Luftstrecke Clearance	Kontakt - Kühlkörper / terminal to heatsink Kontakt - Kontakt / terminal to terminal		7,5 4,0		mm
Vergleichszahl der Kriechwegbildung Comperative tracking index		CTI	> 200		
			min.	typ.	max.
Modulstreuinduktivität Stray inductance module		L <sub>SCE</sub>		25	nH
Modulleitungswiderstand, Anschlüsse - Chip Module lead resistance, terminals - chip	T <sub>H</sub> = 25°C, pro Schalter / per switch	R <sub>CC+EE'</sub>		1,10	mΩ
Lagertemperatur Storage temperature		T <sub>stg</sub>	-40		125 °C
Höchstzulässige Bodenplattenbetriebstemperatur Maximum baseplate operation temperature		T <sub>BPmax</sub>			125 °C
Anzugsdrehmoment f. Modulmontage Mounting torque for modul mounting	Schraube M5 - Montage gem. gültiger Applikationsschrift Screw M5 - Mounting according to valid application note	M	3,00		6,00 Nm
Gewicht Weight		G		300	g

Lagerung und Transport von Modulen mit TIM => siehe AN2012-07  
Storage and shipment of modules with TIM => see AN2012-07

**Ausgangskennlinie IGBT, Wechselrichter (typisch)**  
**output characteristic IGBT, Inverter (typical)**

$I_C = f(V_{CE})$   
 $V_{GE} = 15\text{ V}$

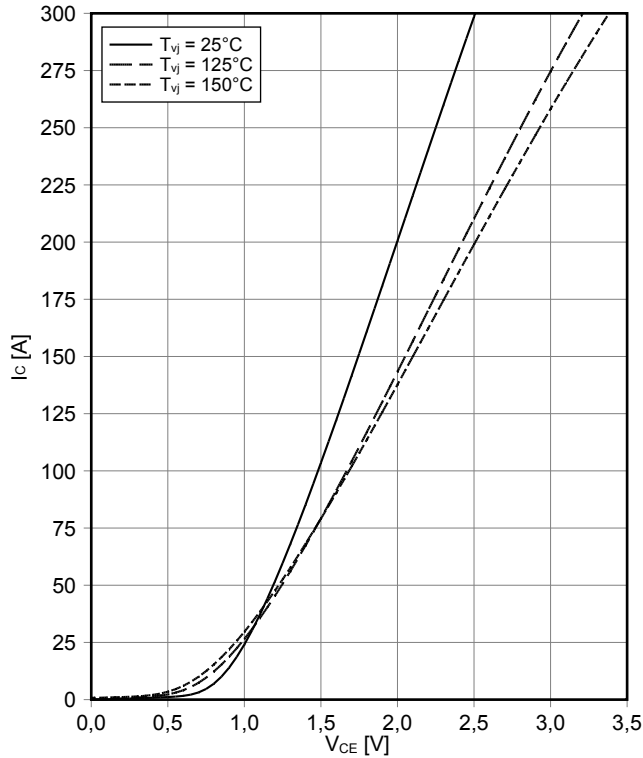

**Ausgangskennlinienfeld IGBT, Wechselrichter (typisch)**  
**output characteristic IGBT, Inverter (typical)**

$I_C = f(V_{CE})$   
 $T_{vj} = 150^\circ\text{C}$

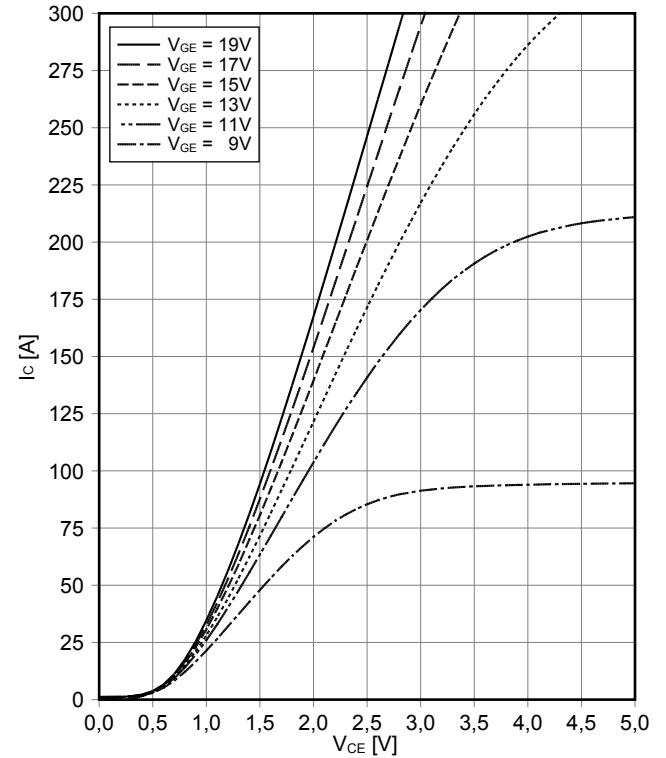

**Übertragungscharakteristik IGBT, Wechselrichter (typisch)**  
**transfer characteristic IGBT, Inverter (typical)**

$I_C = f(V_{GE})$   
 $V_{CE} = 20\text{ V}$

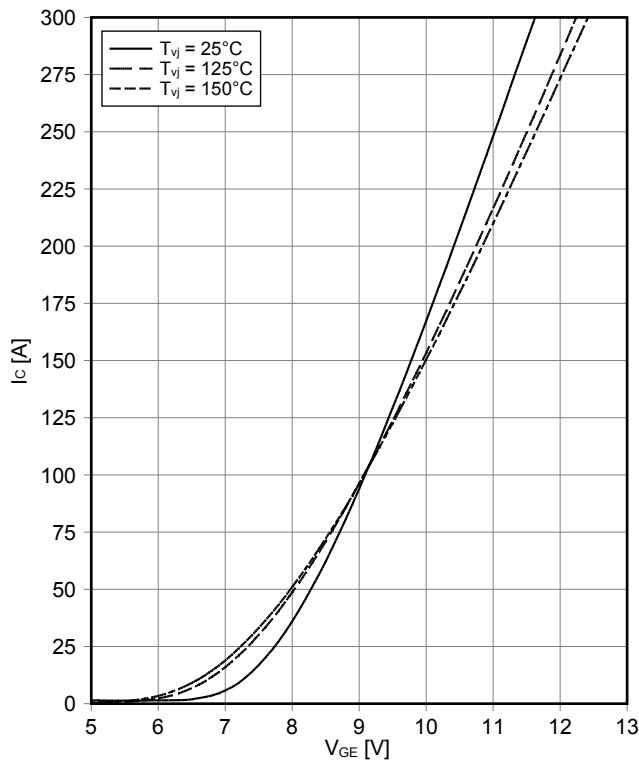

**Schaltverluste IGBT, Wechselrichter (typisch)**  
**switching losses IGBT, Inverter (typical)**

$E_{on} = f(I_C)$ ,  $E_{off} = f(I_C)$   
 $V_{GE} = \pm 15\text{ V}$ ,  $R_{Gon} = 6.8\ \Omega$ ,  $R_{Goff} = 6.8\ \Omega$ ,  $V_{CE} = 600\text{ V}$

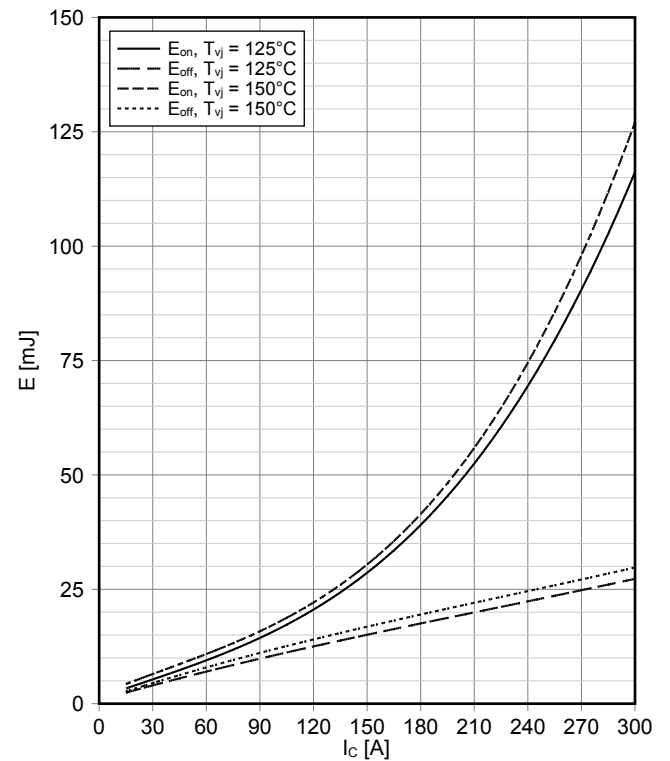

### Schaltverluste IGBT, Wechselrichter (typisch) switching losses IGBT, Inverter (typical)

$E_{on} = f(R_G)$ ,  $E_{off} = f(R_G)$   
 $V_{GE} = \pm 15\text{ V}$ ,  $I_C = 150\text{ A}$ ,  $V_{CE} = 600\text{ V}$

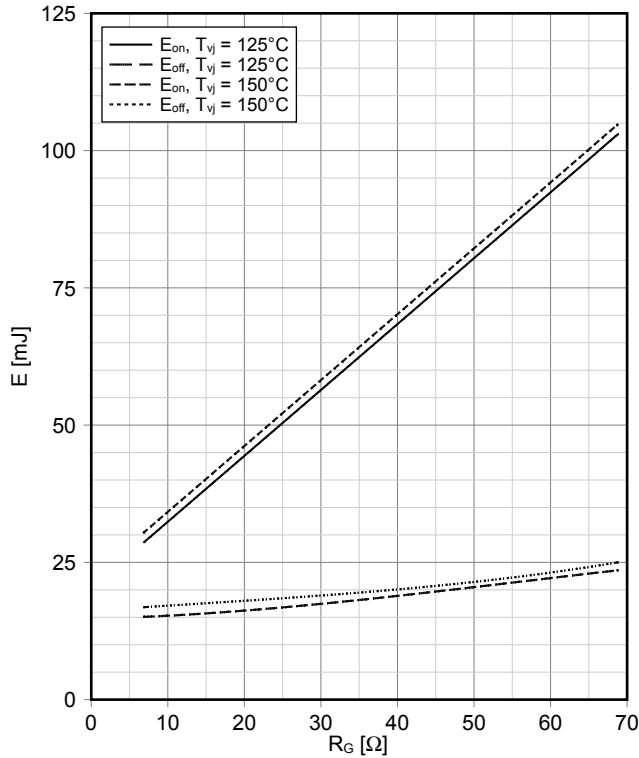

### Transienter Wärmewiderstand IGBT, Wechselrichter transient thermal impedance IGBT, Inverter

$Z_{thJH} = f(t)$

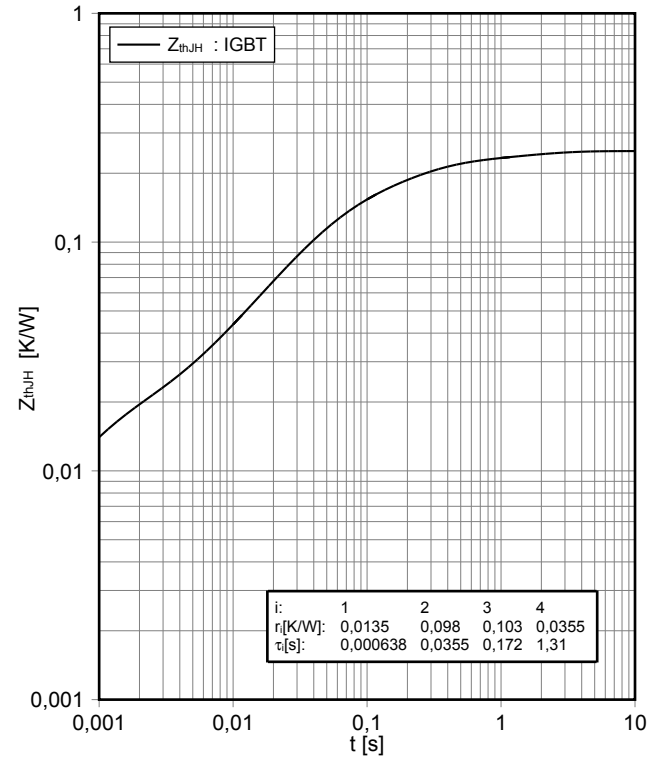

### Sicherer Rückwärts-Arbeitsbereich IGBT, Wechselrichter (RBSOA) reverse bias safe operating area IGBT, Inverter (RBSOA)

$I_C = f(V_{CE})$   
 $V_{GE} = \pm 15\text{ V}$ ,  $R_{Goff} = 6.8\ \Omega$ ,  $T_{vj} = 150^\circ\text{C}$

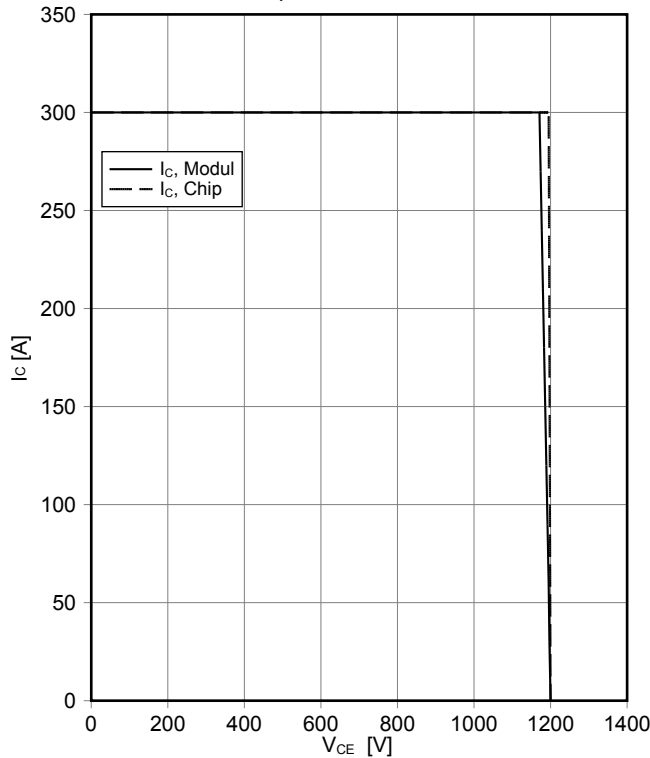

### Durchlasskennlinie der Diode, Wechselrichter (typisch) forward characteristic of Diode, Inverter (typical)

$I_F = f(V_F)$

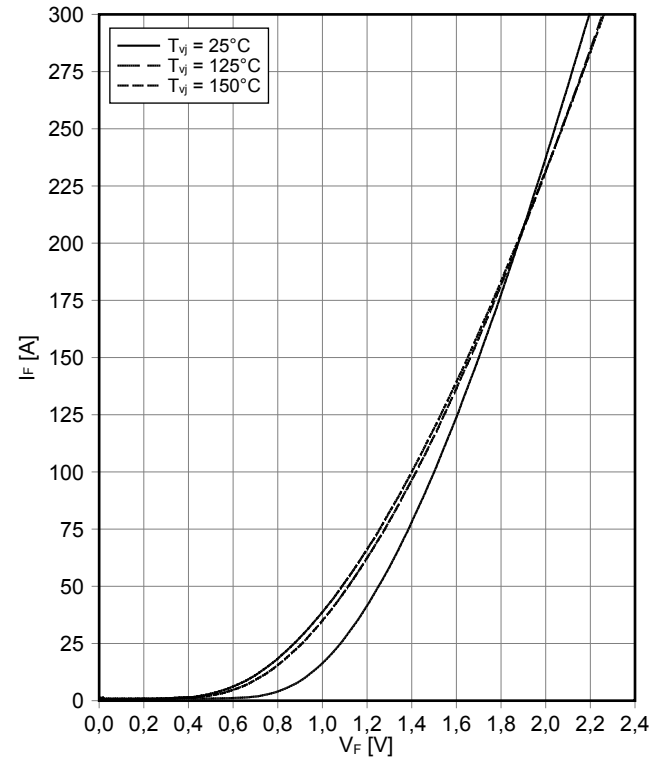



**Schaltverluste Diode, Wechselrichter (typisch)**  
**switching losses Diode, Inverter (typical)**

$E_{rec} = f(I_F)$   
 $R_{Gon} = 6.8 \Omega, V_{CE} = 600 V$



**Schaltverluste Diode, Wechselrichter (typisch)**  
**switching losses Diode, Inverter (typical)**

$E_{rec} = f(R_G)$   
 $I_F = 150 A, V_{CE} = 600 V$

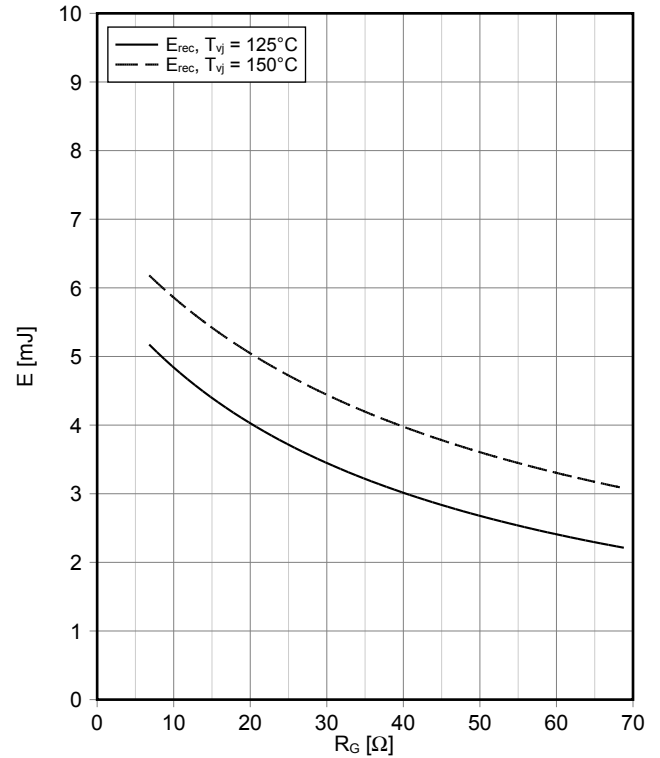

**Transienter Wärmewiderstand Diode, Wechselrichter**  
**transient thermal impedance Diode, Inverter**

$Z_{thJH} = f(t)$

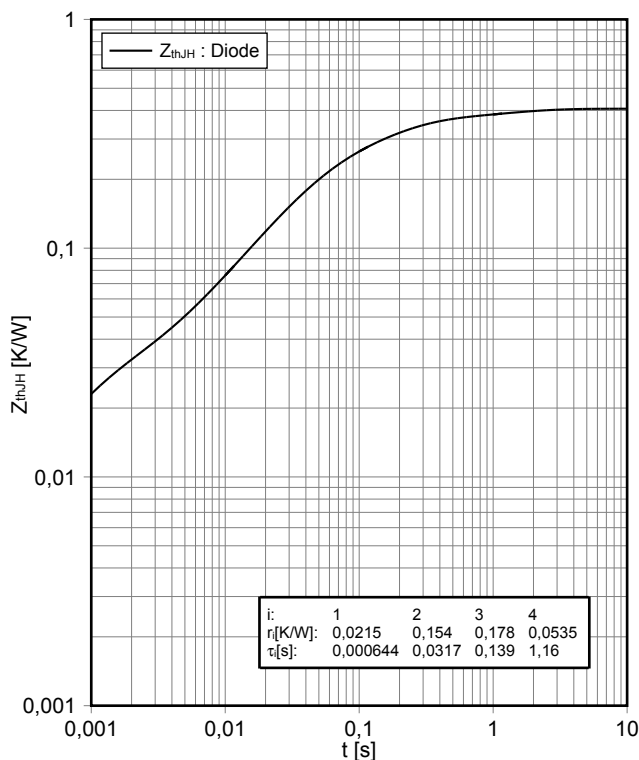

**Durchlasskennlinie der Diode, Gleichrichter (typisch)**  
**forward characteristic of Diode, Rectifier (typical)**

$I_F = f(V_F)$

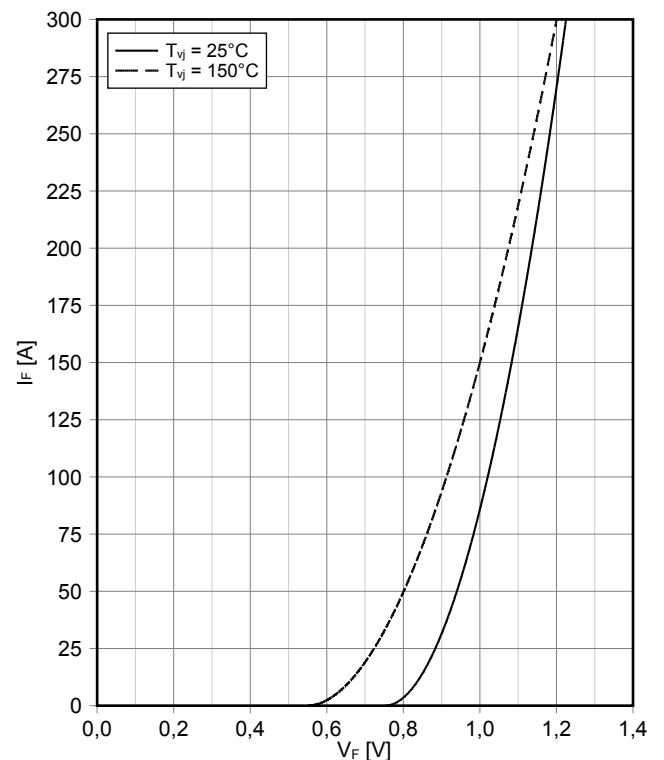

**Ausgangskennlinie IGBT, Brems-Chopper (typisch)**  
**output characteristic IGBT, Brake-Chopper (typical)**

$I_C = f(V_{CE})$   
 $V_{GE} = 15\text{ V}$

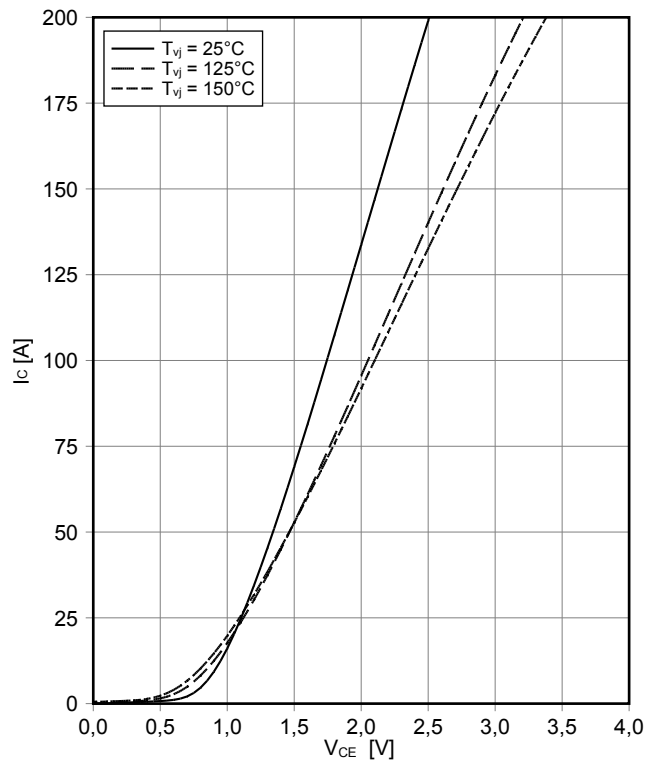

**Durchlasskennlinie der Diode, Brems-Chopper (typisch)**  
**forward characteristic of Diode, Brake-Chopper (typical)**

$I_F = f(V_F)$

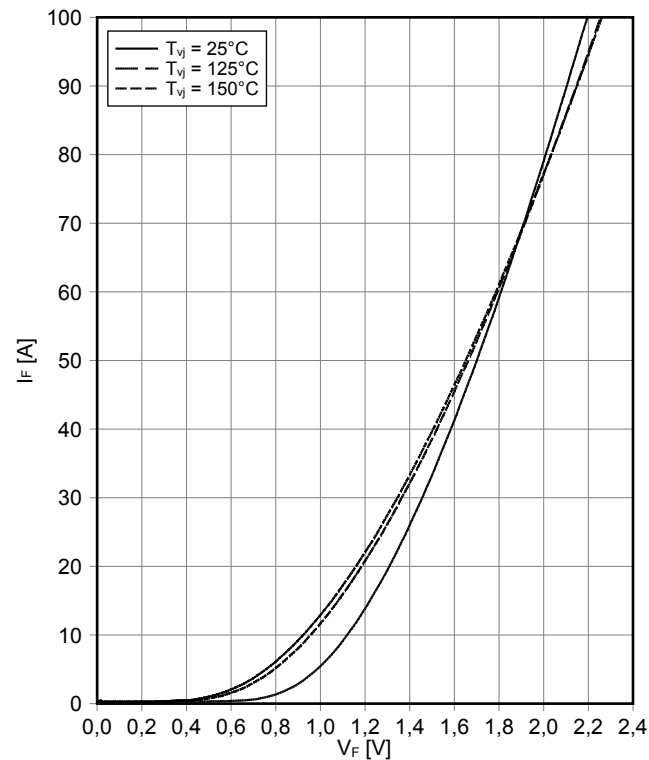

**NTC-Widerstand-Temperaturkennlinie (typisch)**  
**NTC-Thermistor-temperature characteristic (typical)**

$R = f(T)$

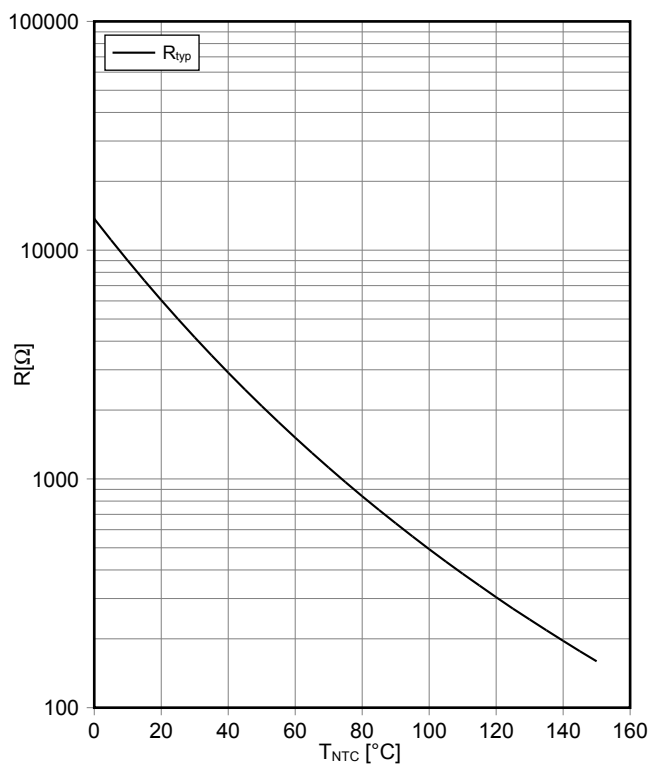

## Schaltplan / Circuit diagram

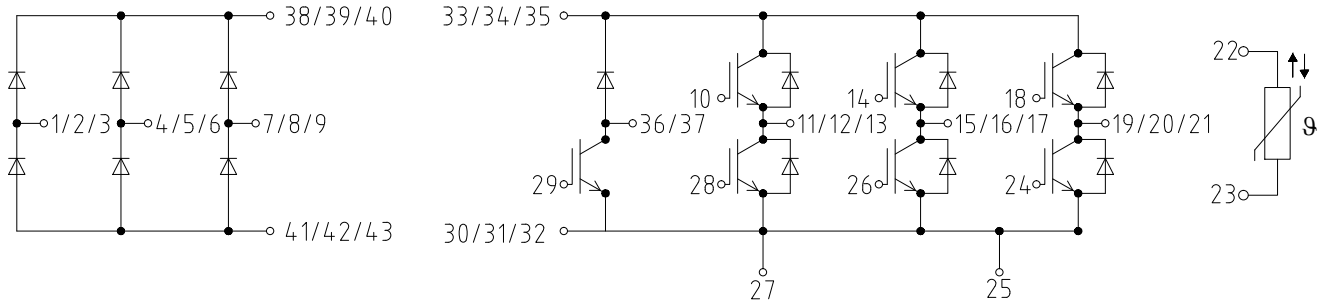

## Gehäuseabmessungen / Package outlines

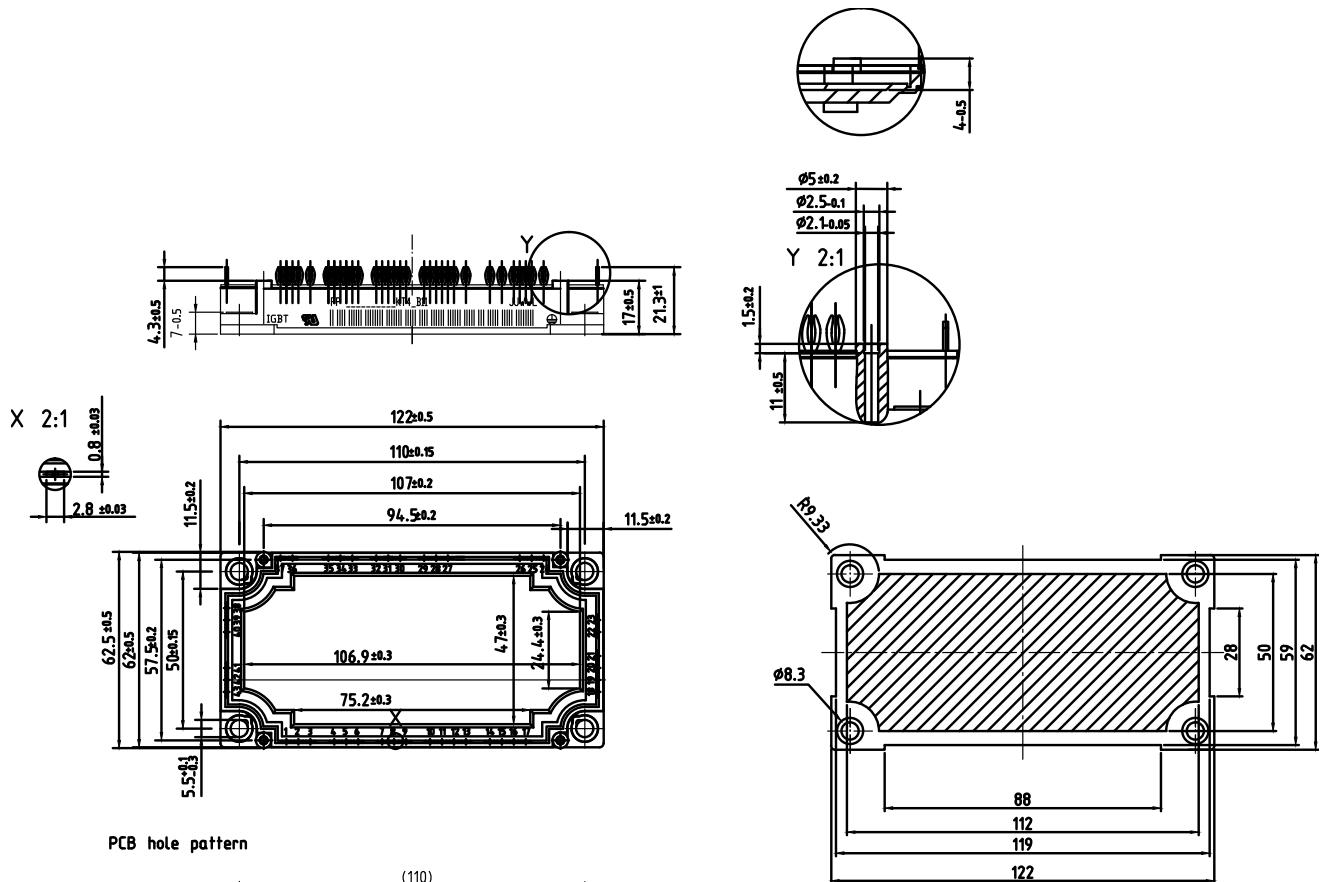

PCB hole pattern

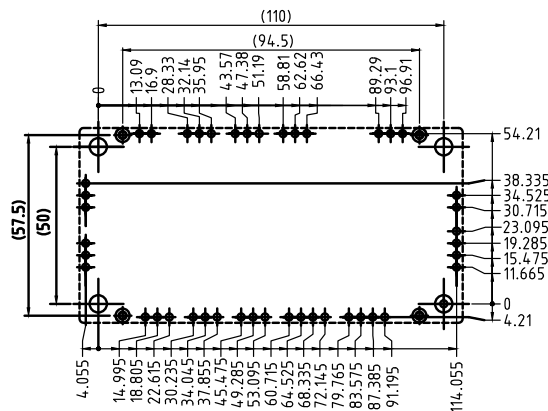

- Tolerance of PCB hole pattern
- hole specifications see AN 2007-09
- Diameters of plated holes  $\phi$  2.14mm - 2.29mm
- Diameter of drill  $\phi$  2.35mm

restricted area for Thermal Interface Material

## Trademarks

All referenced product or service names and trademarks are the property of their respective owners.

Edition 2017-08-21

Published by  
Infineon Technologies AG  
81726 München, Germany

© 2017 Infineon Technologies AG.  
All Rights Reserved.

Do you have a question about this document?  
Email: [erratum@infineon.com](mailto:erratum@infineon.com)

## WICHTIGER HINWEIS

Die in diesem Dokument enthaltenen Angaben stellen keinesfalls Garantien für die Beschaffenheit oder Eigenschaften des Produktes ("Beschaffenhheitsgarantie") dar. Für Beispiele, Hinweise oder typische Werte, die in diesem Dokument enthalten sind, und/oder Angaben, die sich auf die Anwendung des Produktes beziehen, ist jegliche Gewährleistung und Haftung von Infineon Technologies ausgeschlossen, einschließlich, ohne hierauf beschränkt zu sein, die Gewähr dafür, dass kein geistiges Eigentum Dritter verletzt ist.

Des Weiteren stehen sämtliche, in diesem Dokument enthaltenen Informationen, unter dem Vorbehalt der Einhaltung der in diesem Dokument festgelegten Verpflichtungen des Kunden sowie aller im Hinblick auf das Produkt des Kunden sowie die Nutzung des Infineon Produktes in den Anwendungen des Kunden anwendbaren gesetzlichen Anforderungen, Normen und Standards durch den Kunden.

Die in diesem Dokument enthaltenen Daten sind ausschließlich für technisch geschultes Fachpersonal bestimmt. Die Beurteilung der Eignung dieses Produktes für die beabsichtigte Anwendung sowie die Beurteilung der Vollständigkeit der in diesem Dokument enthaltenen Produktdaten für diese Anwendung obliegt den technischen Fachabteilungen des Kunden.

Sollten Sie von uns weitere Informationen im Zusammenhang mit dem Produkt, der Technologie, Lieferbedingungen bzw. Preisen benötigen, wenden Sie sich bitte an das nächste Vertriebsbüro von Infineon Technologies ([www.infineon.com](http://www.infineon.com)).

## WARNHINWEIS

Aufgrund der technischen Anforderungen können Produkte gesundheitsgefährdende Substanzen enthalten. Bei Fragen zu den in diesem Produkt enthaltenen Substanzen, setzen Sie sich bitte mit dem nächsten Vertriebsbüro von Infineon Technologies in Verbindung.

Sofern Infineon Technologies nicht ausdrücklich in einem schriftlichen, von vertretungsberechtigten Infineon Mitarbeitern unterzeichneten Dokument zugestimmt hat, dürfen Produkte von Infineon Technologies nicht in Anwendungen eingesetzt werden, in welchen vernünftigerweise erwartet werden kann, dass ein Fehler des Produktes oder die Folgen der Nutzung des Produktes zu Personenverletzungen führen.

## IMPORTANT NOTICE

The information given in this document shall in no event be regarded as a guarantee of conditions or characteristics ("Beschaffenhheitsgarantie"). With respect to any examples, hints or any typical values stated herein and/or any information regarding the application of the product, Infineon Technologies hereby disclaims any and all warranties and liabilities of any kind, including without limitation warranties of non-infringement of intellectual property rights of any third party.

In addition, any information given in this document is subject to customer's compliance with its obligations stated in this document and any applicable legal requirements, norms and standards concerning customer's products and any use of the product of Infineon Technologies in customer's applications.

The data contained in this document is exclusively intended for technically trained staff. It is the responsibility of customer's technical departments to evaluate the suitability of the product for the intended application and the completeness of the product information given in this document with respect to such application.

For further information on the product, technology, delivery terms and conditions and prices please contact your nearest Infineon Technologies office ([www.infineon.com](http://www.infineon.com)).

## WARNINGS

Due to technical requirements products may contain dangerous substances. For information on the types in question please contact your nearest Infineon Technologies office.

Except as otherwise explicitly approved by Infineon Technologies in a written document signed by authorized representatives of Infineon Technologies, Infineon Technologies' products may not be used in any applications where a failure of the product or any consequences of the use thereof can reasonably be expected to result in personal injury.

单击下面可查看定价，库存，交付和生命周期等信息

[>>Infineon Technologies\(英飞凌\)](#)