

## HIGH RELIABILITY, HIGH EFFICIENCY RADIATION HARDENED DC-DC CONVERTER

## 28V Input, Single Output

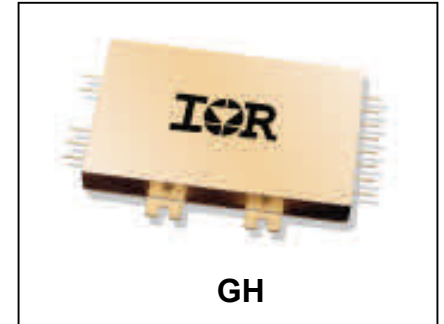

### Description

The GH-Series is a family of low voltage single output DC-DC converters. They are specifically designed in response to the need for low voltage at moderate current levels with the high efficiency and tight regulation dictated by modern digital processing applications. The converters are radiation hardened, high reliability converters designed for extended operation in hostile environments. Their small size and low weight make them ideal for applications such as geostationary earth orbit satellites and deep space probes. They exhibit a high tolerance to total ionizing dose, single event effects and environmental stresses such as temperature extremes, mechanical shock, and vibration. All components are fully de-rated to meet the requirements of MIL-STD-975, MIL-STD-1547 except for the CDR type of capacitors, a capacitor with 50V rating is used for in-circuit voltage stress of less than 10V. Thorough analyses and documentation including beginning-of-life (BOL) and end-of-life (EOL) electrical worst case (WCA) operation, component stress and de-rating, radiation susceptibility (TREE), thermal stress, failure mode and effects (FMEA), and reliability (MTBF) are available for customer review.

The design incorporates a fixed frequency topology with magnetic feedback. Synchronous rectification is deployed to maximize efficiency performance. The converters include an internal EMI filter that is capable of meeting the conducted emission requirements of most major satellite power busses. Incorporation of many functional features including on/off command, remote sensing, and under-voltage lockout make the design suitable for today's space design applications.

The converter is enclosed in a hermetically sealed package with the overall dimensions of 3.5"L x 2.50"W x 0.475"H including the I/O pins and mounting tabs. The package base material is silicon carbide-aluminum (AISIC). The package ring frame is Alloy 48. The package utilizes rugged ceramic feed-through copper core I/O pins and is sealed using parallel seam welding. The total mass of a converter is less than 110 grams.

Manufactured in a facility fully qualified to MIL-PRF-38534, these converters are fabricated utilizing DLA Land and Maritime qualified processes. For available screening options, refer to device screening table in the data sheet.

### Features

- Total Ionization Dose (TID) > 100 kRad(Si)
- SEE Hardened to LET Level > 82 MeV•cm<sup>2</sup>/mg
- Internal EMI filter
- Low Weight, < 110 grams
- Magnetically Coupled Feedback
- 18V to 40V DC Input Range
- Up to 50W Output Power
- Single Output Models Include 1V, 1.5V, 1.8V, 2.5V, 3.3V and 5V
- High Efficiency - to 87%
- -55°C to +85°C Operating Temperature Range
- 100MΩ @ 100V<sub>DC</sub> Isolation
- Under-Voltage Lockout
- Short Circuit and Overload Protection
- Output Voltage Adjust
- Synchronization Output and Input
- Remote Sense
- External Inhibit

### Applications

- Geostationary Earth Orbit Satellites (GEO)
- Deep Space Satellites / Probes
- Strategic Weapons and Communication System

Non-flight versions of the GH-Series converters are available for system development purposes. Variations in electrical specifications and screening to meet custom requirements can be accommodated.

## Specifications

Absolute Maximum Ratings		Recommended Operating Conditions	
Input voltage range	-0.5V <sub>DC</sub> to +60V <sub>DC</sub>	Input voltage range <sup>1</sup>	+18V <sub>DC</sub> to +40V <sub>DC</sub>
Output power	Internally limited	Output power	0 to Max. Rated
Lead temperature	+300°C for 10 seconds	Operating case temperature	-55°C to +85°C
Operating case temperature	-55°C to +125°C (Note 13)	Operating case temperature <sup>1</sup>	-55°C to +70°C
Storage temperature	-55°C to +135°C		

<sup>1</sup> Meets derating per MIL-STD-975

## Electrical Performance Characteristics

Parameter	Group A Subgroup	Conditions -55°C ≤ T <sub>C</sub> ≤ +85°C V <sub>IN</sub> = 28V DC ± 5%, C <sub>L</sub> = 0 unless otherwise specified	Limits			Unit	
			Min	Nom	Max		
Input Voltage			18	28	40	V	
Output Voltage (V <sub>OUT</sub> )			Note 3		Note 3		
GH2801S	1	I <sub>OUT</sub> = 100% rated load	0.98	1.00	1.02	V	
GH2801R5S	1		1.48	1.50	1.52		
GH2801R8S	1		1.77	1.80	1.83		
GH2802R5S	1		2.47	2.50	2.53		
GH2803R3S	1		3.28	3.30	3.32		
GH2805S	1		4.98	5.00	5.02		
GH2801S	2,3		0.96		1.04		
GH2801R5S	2,3		1.45		1.55		
GH2801R8S	2,3		1.75		1.85		
GH2802R5S	2,3		2.45		2.55		
GH2803R3S	2,3		3.24		3.36		
GH2805S	2,3		4.93		5.07		
Output power (P <sub>OUT</sub> )							
GH2801S	1,2,3		V <sub>IN</sub> = 18, 28, 40 Volts, Note 2	0			20
GH2801R5S		0			30		
GH2801R8S		0			36		
GH2802R5S		0			50		
GH2803R3S		0			50		
GH2805S		0			50		
Output current (I <sub>OUT</sub> )							
GH2801S	1,2,3	V <sub>IN</sub> = 18, 28, 40 Volts, Note 2	0		20	A	
GH2801R5S			0		20		
GH2801R8S			0		20		
GH2802R5S			0		20		
GH2803R3S			0		15.15		
GH2805S			0		10		
Line regulation (VR <sub>LINE</sub> )	1,2,3	V <sub>IN</sub> = 18, 28, 40 Volts I <sub>OUT</sub> = 0, 50%, 100% rated	-10		10	mV	
Load regulation (VR <sub>LOAD</sub> )	1,2,3	I <sub>OUT</sub> = 0, 50%, 100% rated V <sub>IN</sub> = 18, 28, 40 Volts	-0.5		0.5	%	
Input current (I <sub>IN</sub> )	1,2,3	I <sub>OUT</sub> = 0, Pin 3 open Pin 3 shorted to pin 2		130 2.0	200 5.0	mA	
Switching frequency (F <sub>S</sub> )	1,2,3	Sync. Input (Pin 4) open	450	500	550	kHz	

For Notes to Electrical Performance Characteristics, refer to page 4.

**Electrical Performance Characteristics (continued)**

Parameter	Group A Subgroup	Conditions -55°C ≤ T <sub>C</sub> ≤ +85°C V <sub>IN</sub> = 28V DC ± 5%, C <sub>L</sub> = 0 unless otherwise specified	Limits			Unit
			Min	Nom	Max	
Synchronization Input frequency range pulse high level pulse low level pulse transition time pulse duty cycle		Ext. Clock on Sync. Input (Pin 4) Note 1	450 4.0 -0.5 80 20		600 10.0 0.5 80	kHz V V V/μs %
Output ripple (V <sub>RIP</sub> ) GH2801S GH2801R5S GH2801R8S GH2802R5S GH2803R3S GH2805S	1,2,3	I <sub>OUT</sub> = 100% rated load Note 4		5 5 5 10 10 10	15 15 15 25 25 30	mVp-p
Efficiency (E <sub>FF</sub> ) GH2801S GH2801R5S GH2801R8S GH2802R5S GH2803R3S GH2805S	1	I <sub>OUT</sub> = 100% rated load	70 72 75 81 83 85	73 75 78 84 85 87		%
Inhibit Input open circuit voltage drive current (sink) voltage range	1,2,3	Note 1	3.0 -0.5		5.0 100 50	V μA V
Current Limit Point Expressed as a percentage of full rated load current	1,2,3	V <sub>OUT</sub> = 90% of Nominal		125	135	%
Power dissipation, load fault (P <sub>D</sub> )	1,2,3	Short Circuit, Overload, Note 6		17	25	W
Output response to step load changes (V <sub>TLD</sub> ) GH2801S GH2801R5S GH2801R8S GH2802R5S GH2803R3S GH2805S	4,5,6	Half Load to/from Full Load, Note 7	-300 -300 -300 -300 -300 -300		300 300 300 300 300 300	mVpk
Recovery time, step load changes (T <sub>TLD</sub> ) GH2801S GH2801R5S GH2801R8S GH2802R5S GH2803R3S GH2805S	4,5,6	Half Load to/from Full Load, Notes 7, 8			250 250 250 250 250	μs
Output response to step line changes (V <sub>TLN</sub> )	4,5,6	24V to/from 32V I <sub>OUT</sub> = 100% rated load, Notes 1, 9	-50		50	mVpk

For Notes to Electrical Performance Characteristics, refer to page 4.

**Electrical Performance Characteristics** (continued)

Parameter	Group A Subgroup	Conditions -55°C ≤ T <sub>C</sub> ≤ +85°C V <sub>IN</sub> = 28V DC ± 5%, C <sub>L</sub> = 0 unless otherwise specified	Limits			Unit
			Min	Nom	Max	
Recovery time, step line changes (T <sub>TLN</sub> )	4,5,6	24V to/from 32V I <sub>OUT</sub> = 100% rated load, Notes 1, 8, 9			200	μs
Turn-on Response Overshoot (V <sub>OSH</sub> ) Turn-on Delay (T <sub>DLY</sub> )	4,5,6	No Load, Full Load Note 10	0		250 5.0	mV ms
Capacitive Load (C <sub>L</sub> )	1	I <sub>OUT</sub> = 100% rated load No effect on DC performance Notes 1, 5			5000	μF
Line Rejection	1	I <sub>OUT</sub> = 100% rated load DC to 50kHz, Note 1	40	60		dB
Electromagnetic Interference (EMI), conducted emission (C <sub>E</sub> )	1	I <sub>OUT</sub> = 100% rated load, Note 1	Per Fig. 3			
Isolation	1	Input to Output or Any Pin to Case except pin 13, test @ 100VDC	100			MΩ
Device Mass					110	g
MTBF		MIL-HDBK-217F2, SF, 35°C, Note 11	5.8x10 <sup>6</sup>			Hrs

**Notes for Electrical Performance Characteristics Table**

- Parameter is tested as part of design characterization or after design changes. Thereafter, parameter shall be guaranteed to the limits specified.
- Parameter verified during line and load regulation tests.
- These are beginning-of-life (BOL) limits. End-of-life (EOL) limits are -3% and +3% of nominal limit for Min and Max, respectively.
- Guaranteed for a D.C. to 20MHz bandwidth. Tested using a 20kHz to 10MHz bandwidth.
- Capacitive load may be any value from 0 to the maximum limit without compromising dc performance. A capacitive load in excess of the maximum limit may interfere with the proper operation of the converter's overload protection, causing erratic behavior during turn-on.
- Overload power dissipation is defined as the device power dissipation with the load set such that V<sub>OUT</sub> = 90% of nominal.
- Load step slew rate ≤ 0.5A/μs.
- Recovery time is measured from the initiation of the transient to where V<sub>OUT</sub> has returned to within ±1% of its steady state value.
- Line step slew rate ≤ 1.0V/μs.
- Turn-on delay time from either a step application of input power or a logic low to a logic high transition on the inhibit pin (pin 3) to the point where V<sub>OUT</sub> = 90% of nominal.
- MIL-HDBK MOSFET failure rates replaced by empirical failure rate data supplied by IR HiRel.

**Radiation Performance Characteristics**

Test Inspection	Method	Min	Typ	Unit
Total Ionizing Dose (Gamma)	MIL-PRF-883, Method 1019.5 Operating bias applied during exposure, Half Rated Load, V <sub>IN</sub> = 28V	100		kRads(Si)
Single Event Effects SEU, SEL, SEGR, SEB	Heavy Ions (LET) Operating bias applied during exposure, Half Rated Load, V <sub>IN</sub> = 18V, 28V & 50V <b>Test lab: Cyclotron Institute Texas A &amp; M University</b>	82		MeV•cm <sup>2</sup> /mg

IR HiRel currently does not have a DLA Land and Maritime certified Radiation Hardness Assurance Program.

**Fig. 1 –Typical Efficiency vs Output Current @ 25°C, 5V Output (GH2805S)**

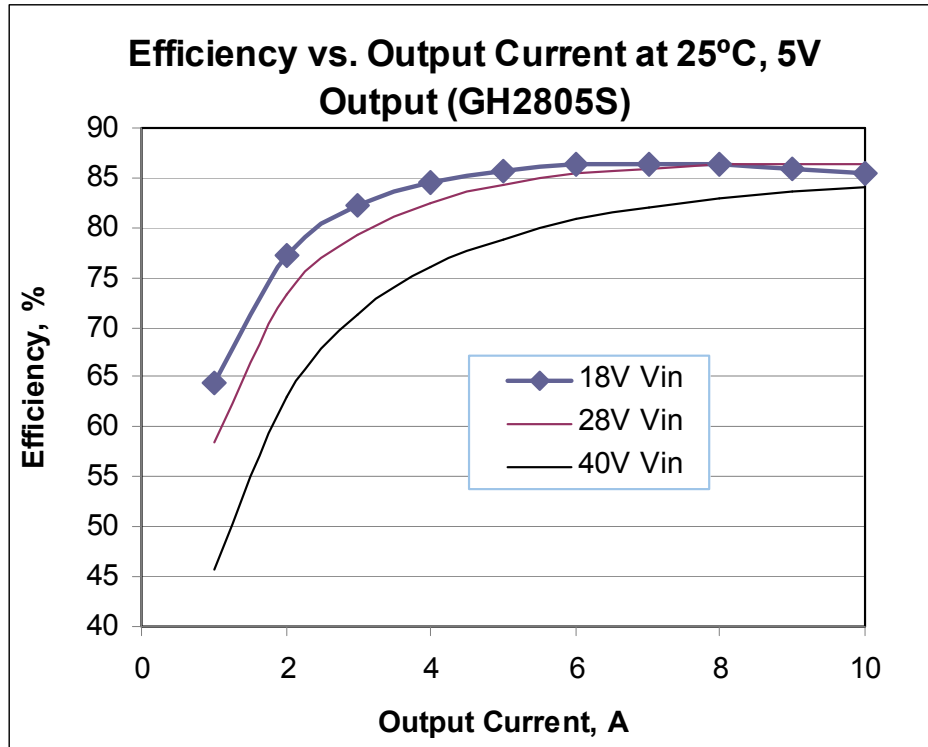

**Fig. 2 –Typical Efficiency vs Temperature, 5V Output (GH2805S)**

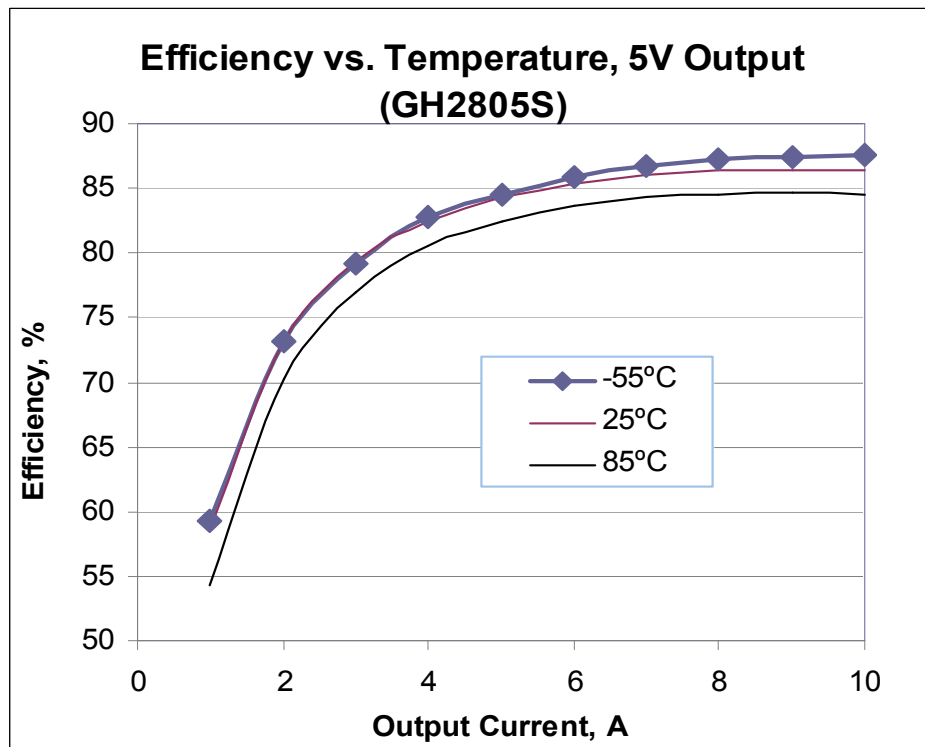

**Fig. 3 – EMI CE03 Specification Limits and Typical Performance**

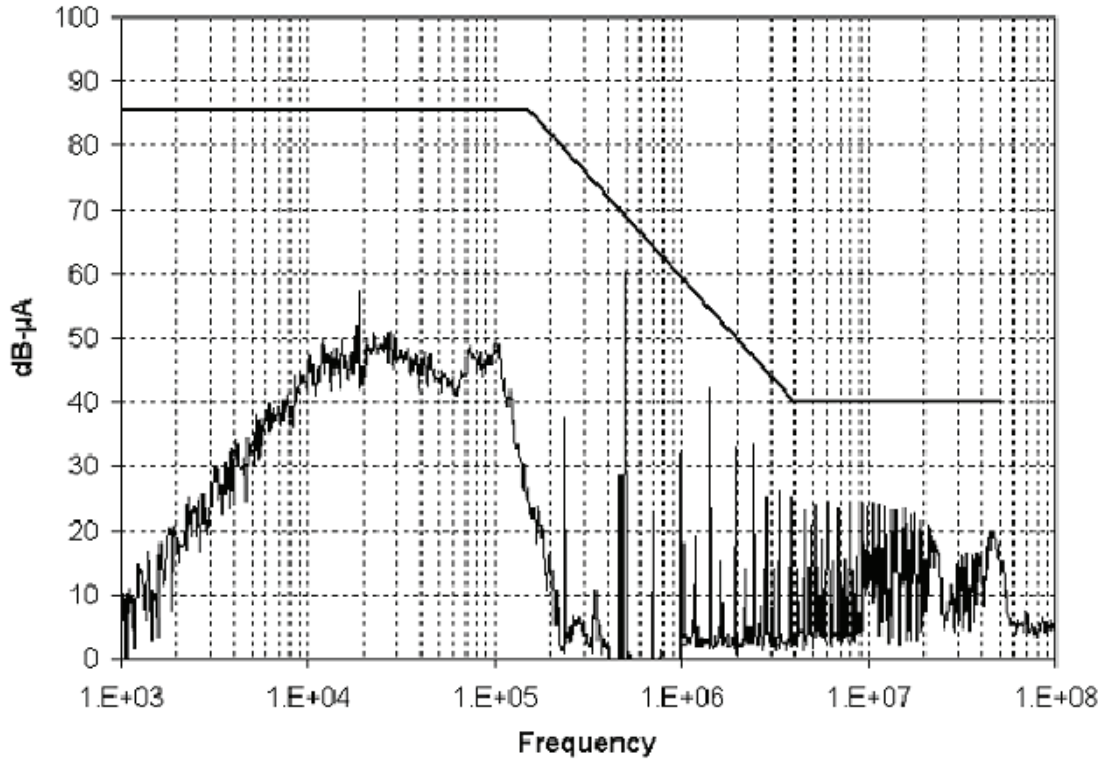

**Fig. 4 - Block Diagram - Single Output**

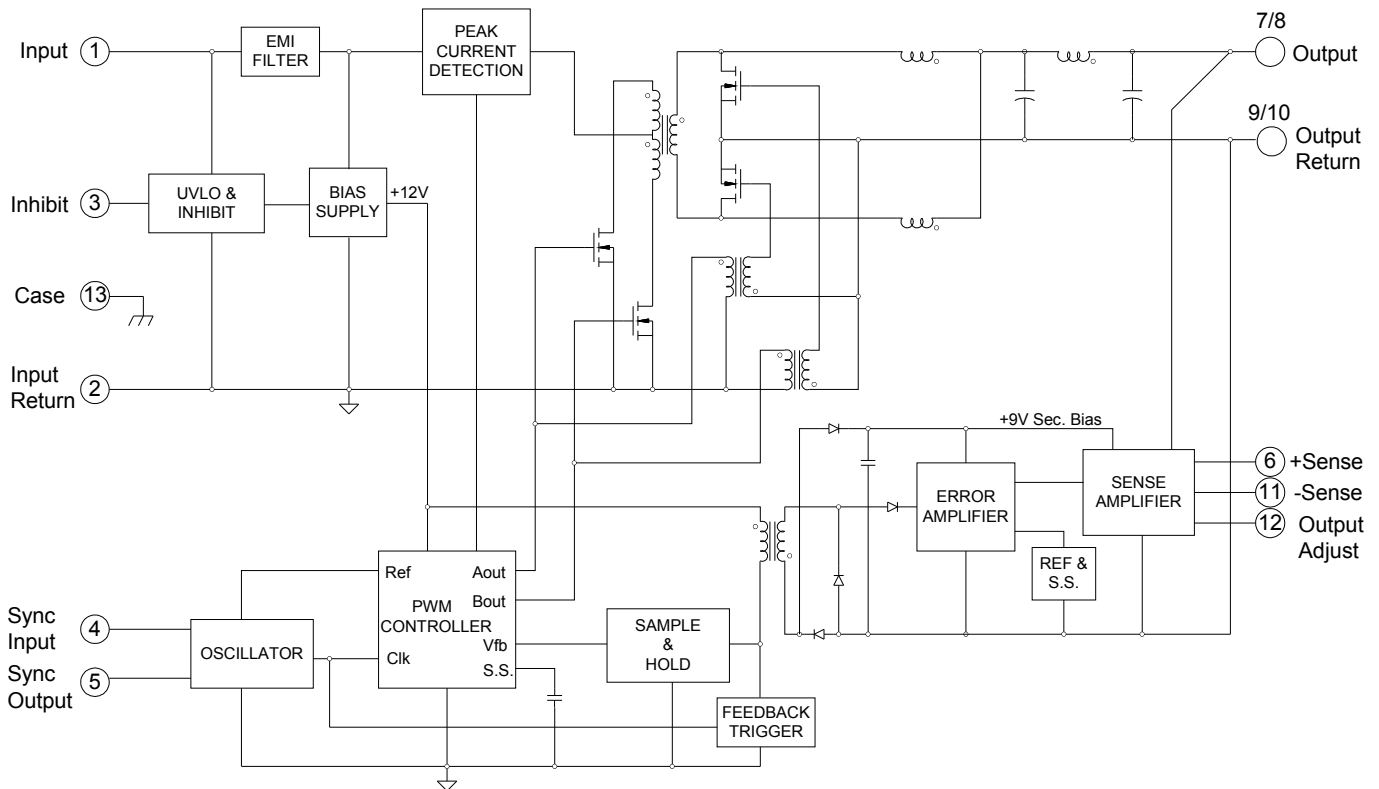

**Application Note:**

The GH-Series converters have an *Output Adjust* pin (pin 12), which when connected via an external resistor ( $R_{ADJ}$ ) to either the *-sense* (pin 11) or *+sense* (pin 6), allows the nominal output voltage to be adjusted. Use the following equations with the parameters listed in Table 1 to calculate the required resistor value ( $R_{ADJ}$ ).

For **all Models**, to adjust the output voltage higher:

$$R_{ADJ} = \frac{2 \times A}{V_{OUT} - V_{NOM}} - B$$

- where:  $R_{ADJ}$  is in Kohms
- $R_{ADJ}$  is connected to *-sense* and  $V_{NOM} < V_{OUT} < 1.1V_{NOM}$
- $V_{NOM}$  is the nominal output voltage with the Adjust Pin left open
- $V_{OUT}$  is the desired output voltage
- A** and **B** are parameters defined in Table 1

For **all Models**, to adjust the output voltage lower:

$$R_{ADJ} = \frac{1}{\left( \frac{A}{C(V_{OUT} - A)} - 0.5 \right)} - B$$

- where:  $R_{ADJ}$  is in Kohms
- $R_{ADJ}$  is connected to *+sense* and  $D < V_{OUT} < V_{NOM}$
- $V_{NOM}$  is the nominal output voltage with the Adjust Pin left open
- $V_{OUT}$  is the desired output voltage
- A, B, C** and **D** are parameters defined in Table 1

**Table 1. Equation Parameters by Model**

MODEL	EQUATION PARAMETERS			
	A	B	C	D
GH2801S	0.714	14.3	5.0	0.965
GH2801R5S	0.937	12.6	3.33	1.425
GH2801R8S	1.047	11.5	2.78	1.689
GH2802R5S	1.25	10	2.0	2.292
GH2803R3S	1.425	8.34	1.52	2.937
GH2805S	1.667	6.68	1.0	4.233

**Mechanical Outline**

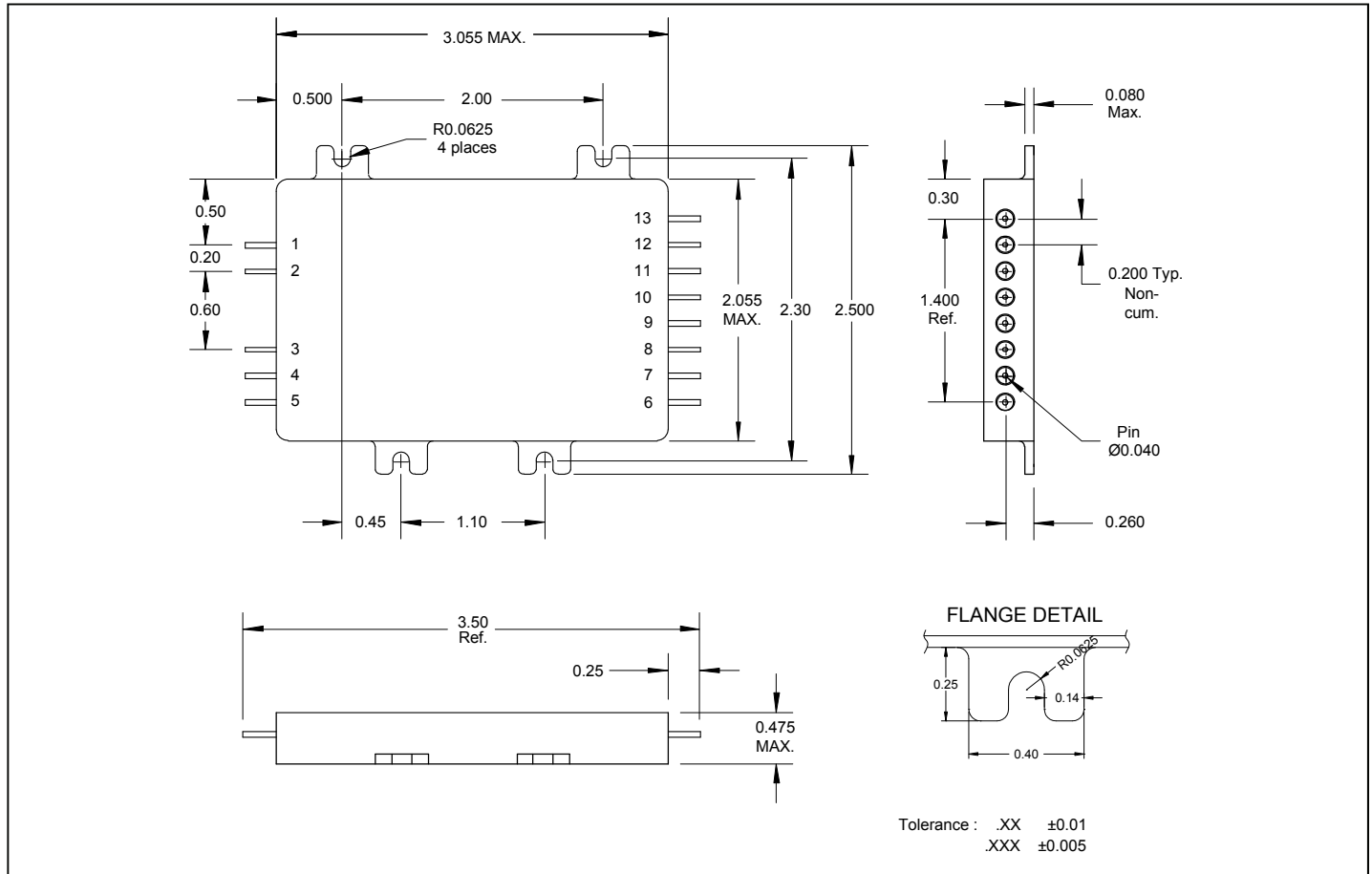

**Pin Designation**

Pin #	Designation	Pin #	Designation
1	Input	8	Output
2	Input Return	9	Output Return
3	Inhibit	10	Output Return
4	Sync Input	11	- Sense
5	Sync Output	12	Output Adjust
6	+ Sense	13	Case
7	Output		

**Standard Microcircuit Drawing Equivalence Table**

Standard Microcircuit Drawing Number	IR Standard Part Number
5962-1021701KXX	GH2803R3S/CKX
5962-1021901KXX	GH2805S/CKX



**Device Screening**

Requirement	MIL-STD-883 Method	No Suffix ②	CK②	EM ③
Temperature Range	—	-55°C to +85°C	-55°C to +85°C	-55°C to +85°C
Element Evaluation	MIL-PRF-38534	Class K	Class K	N/A
Non-Destructive Bond Pull	2023	Yes	Yes	N/A
Internal Visual	2017	Yes	Yes	①
Temperature Cycle	1010	Cond C	Cond C	Cond C
Constant Acceleration	2001, Y1 Axis	3000 Gs	3000 Gs	3000 Gs
PIND	2020	Cond A	Cond A	N/A
Burn-In	1015	320 hrs @ 125°C (2 x 160 hrs)	320 hrs @ 125°C (2 x 160 hrs)	48 hrs @ 125°C
Final Electrical (Group A)	MIL-PRF-38534 & Specification	-55°C, +25°C, +85°C	-55°C, +25°C, +85°C	-55°C, +25°C, +85°C
PDA	MIL-PRF-38534	2%	2%	N/A
Seal, Fine and Gross	1014	Cond A, C	Cond A, C	Cond A
Radiographic	2012	Yes	Yes	N/A
External Visual	2009	Yes	Yes	①

**Notes:**

- ① Best commercial practice.
- ② CK is a DLA Land and Maritime (formerly DSCC) part marking used to designate a Class K compliant hybrid. The CK marking does not indicate the hybrid is radiation certified. No suffix is a radiation rated device but not available as a DLA qualified SMD per MIL-PRF-38534.
- ③ Any Engineering Model (EM) build with the "EM" Suffix shall only be form, fit and functional equivalent to its Flight Model (FM) counterpart, and it may not meet the radiation performance. The EM Model shall not be expected comply with MIL-PRF-38534 flight quality/workmanship standards, and configuration control. An EM build may use electrical equivalent commercial grade components. IR HiRel will provide a list of non-compliance items upon request.

**Part Numbering**

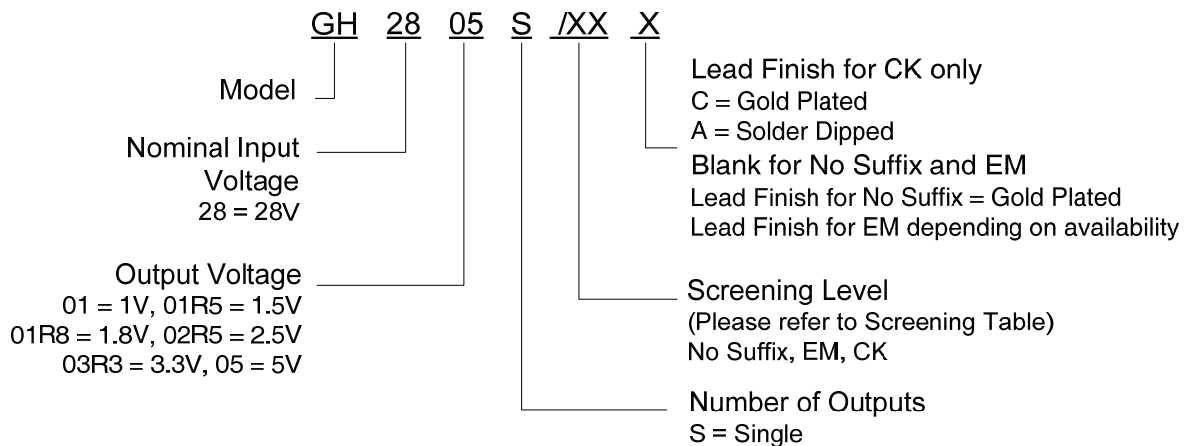

### **IMPORTANT NOTICE**

The information given in this document shall be in no event regarded as guarantee of conditions or characteristic. The data contained herein is a characterization of the component based on internal standards and is intended to demonstrate and provide guidance for typical part performance. It will require further evaluation, qualification and analysis to determine suitability in the application environment to confirm compliance to your system requirements.

With respect to any example hints or any typical values stated herein and/or any information regarding the application of the product, Infineon Technologies hereby disclaims any and all warranties and liabilities of any kind including without limitation warranties on non- infringement of intellectual property rights and any third party.

In addition, any information given in this document is subject to customer's compliance with its obligations stated in this document and any applicable legal requirements, norms and standards concerning customer's product and any use of the product of Infineon Technologies in customer's applications.

The data contained in this document is exclusively intended for technically trained staff. It is the responsibility of any customer's technical departments to evaluate the suitability of the product for the intended applications and the completeness of the product information given in this document with respect to applications.

For further information on the product, technology, delivery terms and conditions and prices, please contact your local sales representative or go to ([www.infineon.com/hirel](http://www.infineon.com/hirel)).

### **WARNING**

Due to technical requirements products may contain dangerous substances. For information on the types in question, please contact your nearest Infineon Technologies office.

单击下面可查看定价，库存，交付和生命周期等信息

[>>Infineon Technologies\(英飞凌\)](#)