

IRG4BC30FDPbF

INSULATED GATE BIPOLAR TRANSISTOR WITH ULTRAFAST
 SOFT RECOVERY DIODE

Fast CoPack IGBT

Features

- Fast: Optimized for medium operating frequencies (1-5 kHz in hard switching, >20kHz in resonant mode).
- Generation 4 IGBT design provides tighter parameter distribution and higher efficiency than Generation 3
- IGBT co-packaged with HEXFRED™ ultrafast, ultra-soft-recovery anti-parallel diodes for use in bridge configurations
- Industry standard TO-220AB package
- Lead-Free

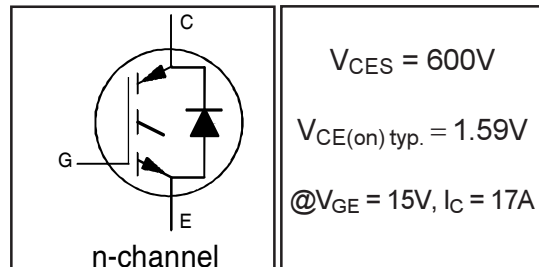

Benefits

- Generation -4 IGBT's offer highest efficiencies available
- IGBT's optimized for specific application conditions
- HEXFRED diodes optimized for performance with IGBT's. Minimized recovery characteristics require less/no snubbing
- Designed to be a "drop-in" replacement for equivalent industry-standard Generation 3 IR IGBT's

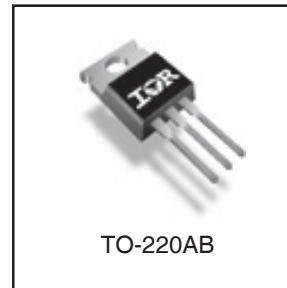

Absolute Maximum Ratings

| | Parameter | Max. | Units |
|---------------------------------|--|---------------------|------------------|
| V_{CES} | Collector-to-Emitter Voltage | 600 | V |
| $I_C @ T_C = 25^\circ\text{C}$ | Continuous Collector Current | 31 | A |
| $I_C @ T_C = 100^\circ\text{C}$ | Continuous Collector Current | 17 | |
| I_{CM} | Pulsed Collector Current ① | 124 | |
| I_{LM} | Clamped Inductive Load Current ② | 124 | |
| $I_F @ T_C = 100^\circ\text{C}$ | Diode Continuous Forward Current | 12 | |
| I_{FM} | Diode Maximum Forward Current | 120 | |
| V_{GE} | Gate-to-Emitter Voltage | ± 20 | V |
| $P_D @ T_C = 25^\circ\text{C}$ | Maximum Power Dissipation | 100 | W |
| $P_D @ T_C = 100^\circ\text{C}$ | Maximum Power Dissipation | 42 | |
| T_J | Operating Junction and Storage Temperature Range | -55 to +150 | $^\circ\text{C}$ |
| T_{STG} | | | |
| | | | |
| | Mounting Torque, 6-32 or M3 Screw. | 10 lbf•in (1.1 N•m) | |

Thermal Resistance

| | Parameter | Min. | Typ. | Max. | Units |
|-----------------|---|-------|----------|-------|--------------------|
| $R_{\theta JC}$ | Junction-to-Case - IGBT | ----- | ----- | 1.2 | $^\circ\text{C/W}$ |
| $R_{\theta JC}$ | Junction-to-Case - Diode | ----- | ----- | 2.5 | |
| $R_{\theta CS}$ | Case-to-Sink, flat, greased surface | ----- | 0.50 | ----- | |
| $R_{\theta JA}$ | Junction-to-Ambient, typical socket mount | ----- | ----- | 80 | |
| W_t | Weight | ----- | 2 (0.07) | ----- | g (oz) |

IRG4BC30FDPbF

Electrical Characteristics @ T_J = 25°C (unless otherwise specified)

| | Parameter | Min. | Typ. | Max. | Units | Conditions |
|--|---|------|------|------|-------|--|
| V _{(BR)CES} | Collector-to-Emitter Breakdown Voltage ^③ | 600 | ---- | ---- | V | V _{GE} = 0V, I _C = 250μA |
| ΔV _{(BR)CES} /ΔT _J | Temperature Coeff. of Breakdown Voltage | ---- | 0.69 | ---- | V/°C | V _{GE} = 0V, I _C = 1.0mA |
| V _{CE(on)} | Collector-to-Emitter Saturation Voltage | ---- | 1.59 | 1.8 | V | I _C = 17A V _{GE} = 15V |
| | | ---- | 1.99 | ---- | | I _C = 31A See Fig. 2, 5 |
| | | ---- | 1.70 | ---- | | I _C = 17A, T _J = 150°C |
| V _{GE(th)} | Gate Threshold Voltage | 3.0 | ---- | 6.0 | | V _{CE} = V _{GE} , I _C = 250μA |
| ΔV _{GE(th)} /ΔT _J | Temperature Coeff. of Threshold Voltage | ---- | -11 | ---- | mV/°C | V _{CE} = V _{GE} , I _C = 250μA |
| g _{fe} | Forward Transconductance ^④ | 6.1 | 10 | ---- | S | V _{CE} = 100V, I _C = 17A |
| I _{CES} | Zero Gate Voltage Collector Current | ---- | ---- | 250 | μA | V _{GE} = 0V, V _{CE} = 600V |
| | | ---- | ---- | 2500 | | V _{GE} = 0V, V _{CE} = 600V, T _J = 150°C |
| V _{FM} | Diode Forward Voltage Drop | ---- | 1.4 | 1.7 | V | I _C = 12A See Fig. 13 |
| | | ---- | 1.3 | 1.6 | | I _C = 12A, T _J = 150°C |
| I _{GES} | Gate-to-Emitter Leakage Current | ---- | ---- | ±100 | nA | V _{GE} = ±20V |

Switching Characteristics @ T_J = 25°C (unless otherwise specified)

| | Parameter | Min. | Typ. | Max. | Units | Conditions | |
|--------------------------|---|------|------|------|---|--|--|
| Q _g | Total Gate Charge (turn-on) | ---- | 51 | 77 | nC | I _C = 17A | |
| Q _{ge} | Gate - Emitter Charge (turn-on) | ---- | 7.9 | 12 | | V _{CC} = 400V See Fig. 8 | |
| Q _{gc} | Gate - Collector Charge (turn-on) | ---- | 19 | 28 | | V _{GE} = 15V | |
| t _{d(on)} | Turn-On Delay Time | ---- | 42 | ---- | ns | T _J = 25°C | |
| t _r | Rise Time | ---- | 26 | ---- | | I _C = 17A, V _{CC} = 480V | |
| t _{d(off)} | Turn-Off Delay Time | ---- | 230 | 350 | | V _{GE} = 15V, R _G = 23Ω | |
| t _f | Fall Time | ---- | 160 | 230 | mJ | Energy losses include "tail" and diode reverse recovery. | |
| E _{on} | Turn-On Switching Loss | ---- | 0.63 | ---- | | See Fig. 9, 10, 11, 18 | |
| E _{off} | Turn-Off Switching Loss | ---- | 1.39 | ---- | | | |
| E _{ts} | Total Switching Loss | ---- | 2.02 | 3.9 | mJ | | |
| t _{d(on)} | Turn-On Delay Time | ---- | 42 | ---- | | ns | T _J = 150°C, See Fig. 9, 10, 11, 18 |
| t _r | Rise Time | ---- | 27 | ---- | | | I _C = 17A, V _{CC} = 480V |
| t _{d(off)} | Turn-Off Delay Time | ---- | 310 | ---- | V _{GE} = 15V, R _G = 23Ω | | |
| t _f | Fall Time | ---- | 310 | ---- | mJ | Energy losses include "tail" and diode reverse recovery. | |
| E _{ts} | Total Switching Loss | ---- | 3.2 | ---- | | | |
| L _E | Internal Emitter Inductance | ---- | 7.5 | ---- | | nH | Measured 5mm from package |
| C _{ies} | Input Capacitance | ---- | 1100 | ---- | pF | V _{GE} = 0V | |
| C _{oes} | Output Capacitance | ---- | 74 | ---- | | V _{CC} = 30V See Fig. 7 | |
| C _{res} | Reverse Transfer Capacitance | ---- | 14 | ---- | | f = 1.0MHz | |
| t _{rr} | Diode Reverse Recovery Time | ---- | 42 | 60 | ns | T _J = 25°C See Fig. 14 | |
| | | ---- | 80 | 120 | | T _J = 125°C | |
| I _{rr} | Diode Peak Reverse Recovery Current | ---- | 3.5 | 6.0 | A | T _J = 25°C See Fig. 15 | |
| | | ---- | 5.6 | 10 | | T _J = 125°C | |
| Q _{rr} | Diode Reverse Recovery Charge | ---- | 80 | 180 | nC | T _J = 25°C See Fig. 16 | |
| | | ---- | 220 | 600 | | T _J = 125°C | |
| di _(rec) M/dt | Diode Peak Rate of Fall of Recovery During t _b | ---- | 180 | ---- | A/μs | T _J = 25°C See Fig. 17 | |
| | | ---- | 120 | ---- | | T _J = 125°C | |

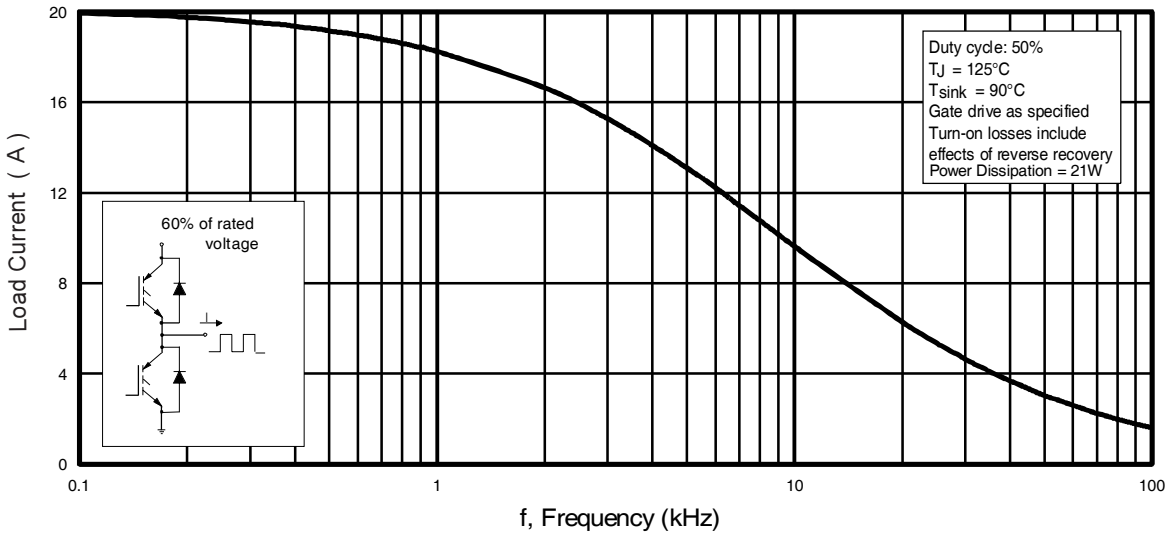

Fig. 1 - Typical Load Current vs. Frequency
(Load Current = I_{RMS} of fundamental)

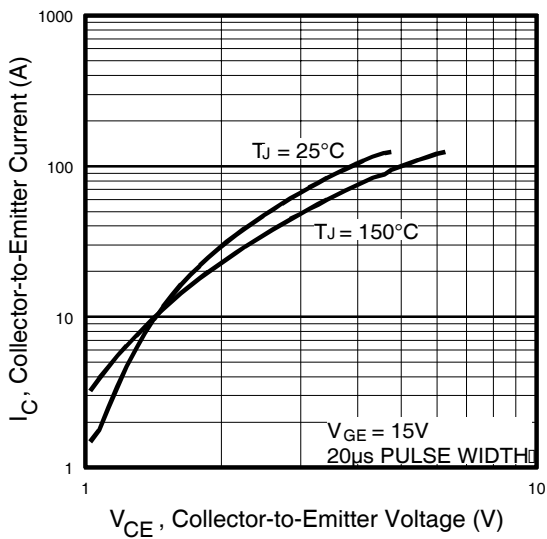

Fig. 2 - Typical Output Characteristics
www.irf.com

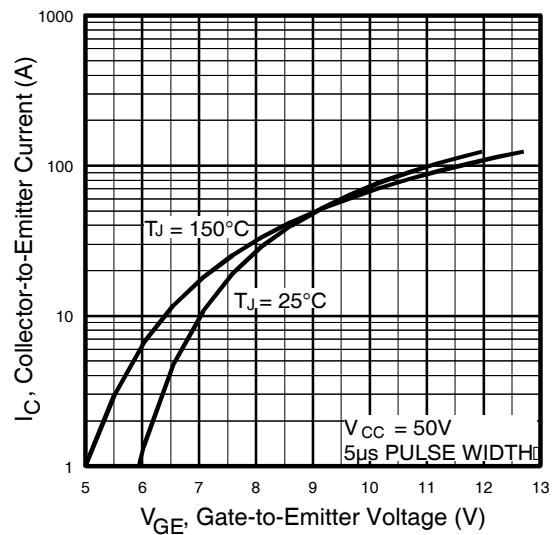

Fig. 3 - Typical Transfer Characteristics

IRG4BC30FDPbF

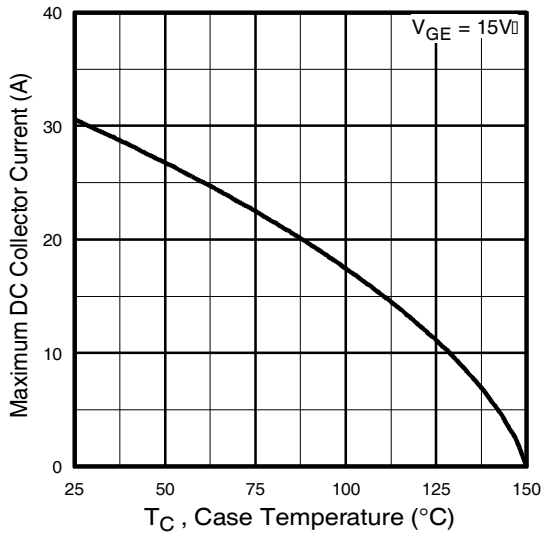

Fig. 4 - Maximum Collector Current vs. Case Temperature

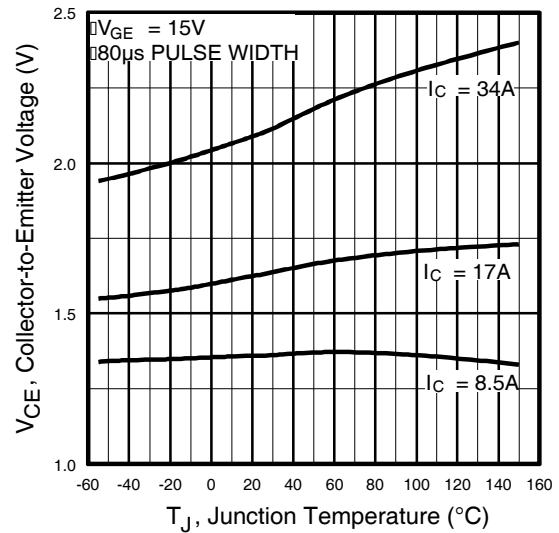

Fig. 5 - Typical Collector-to-Emitter Voltage vs. Junction Temperature

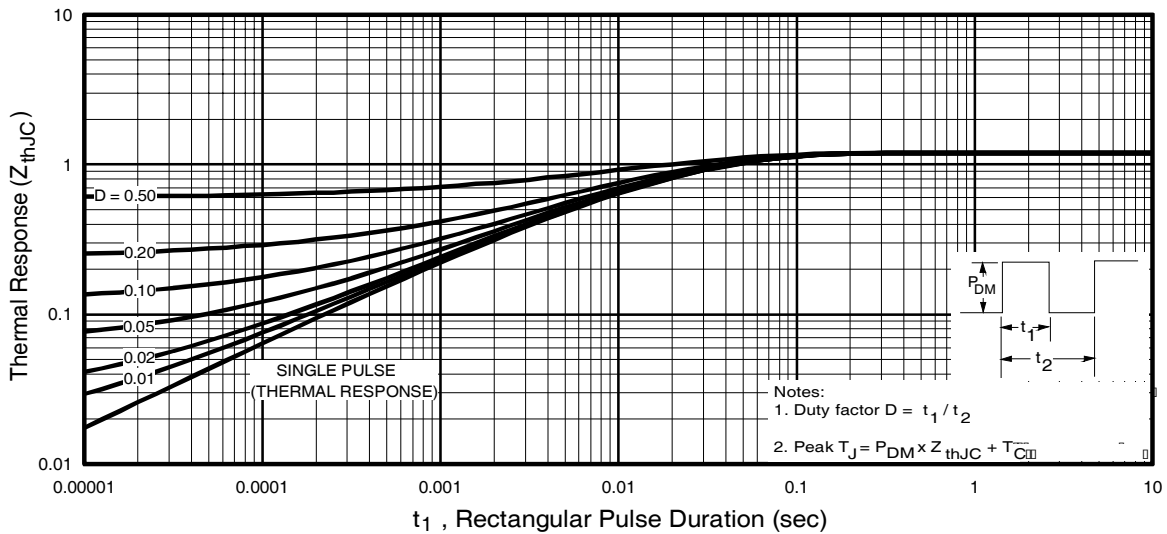

Fig. 6 - Maximum Effective Transient Thermal Impedance, Junction-to-Case

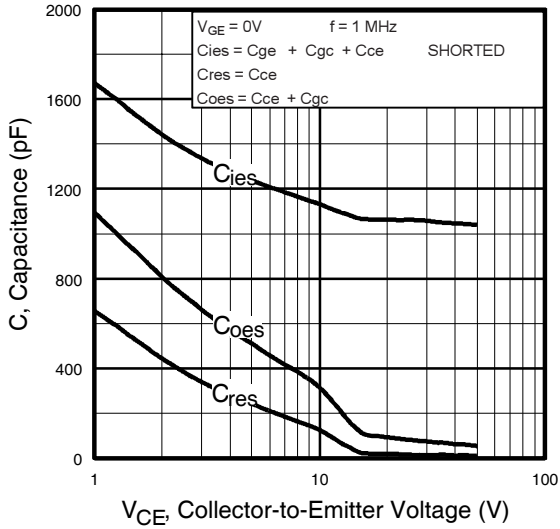

Fig. 7 - Typical Capacitance vs. Collector-to-Emitter Voltage

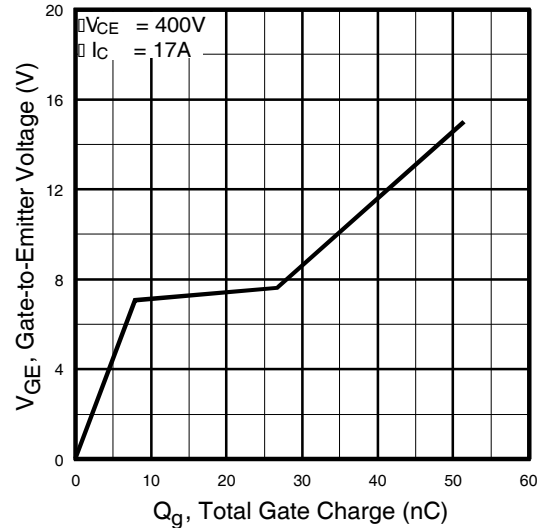

Fig. 8 - Typical Gate Charge vs. Gate-to-Emitter Voltage

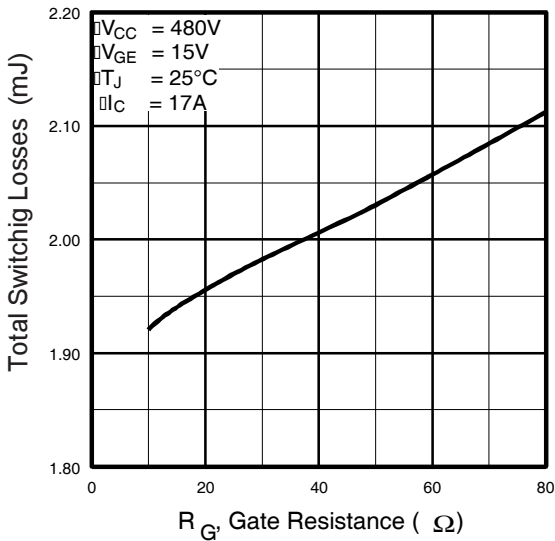

Fig. 9 - Typical Switching Losses vs. Gate Resistance

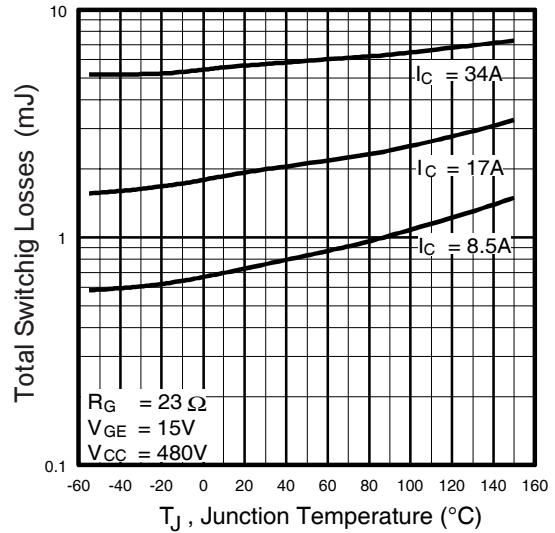

Fig. 10 - Typical Switching Losses vs. Junction Temperature

IRG4BC30FDPbF

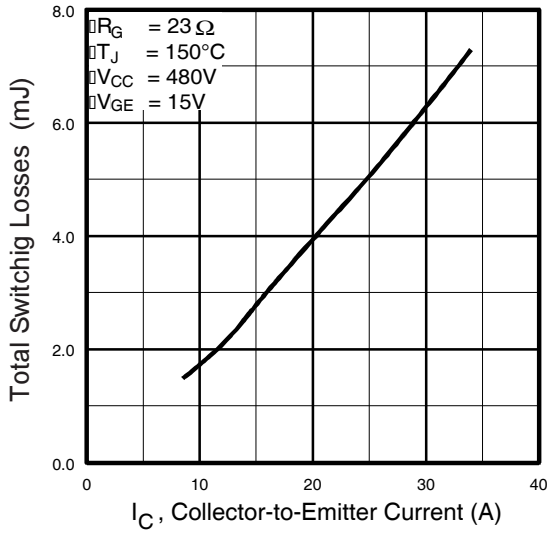

Fig. 11 - Typical Switching Losses vs. Collector-to-Emitter Current

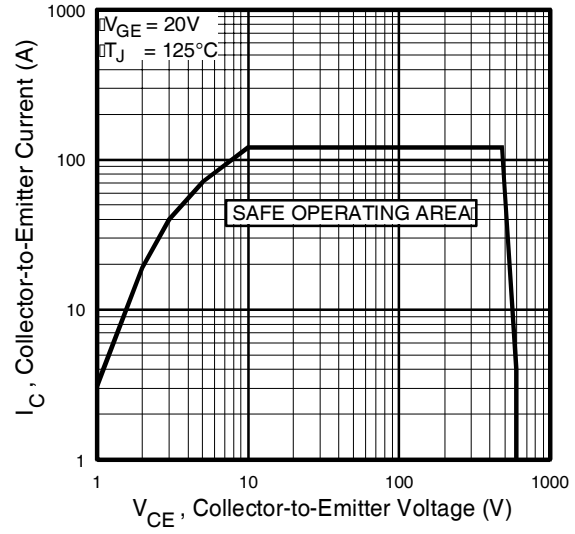

Fig. 12 - Turn-Off SOA

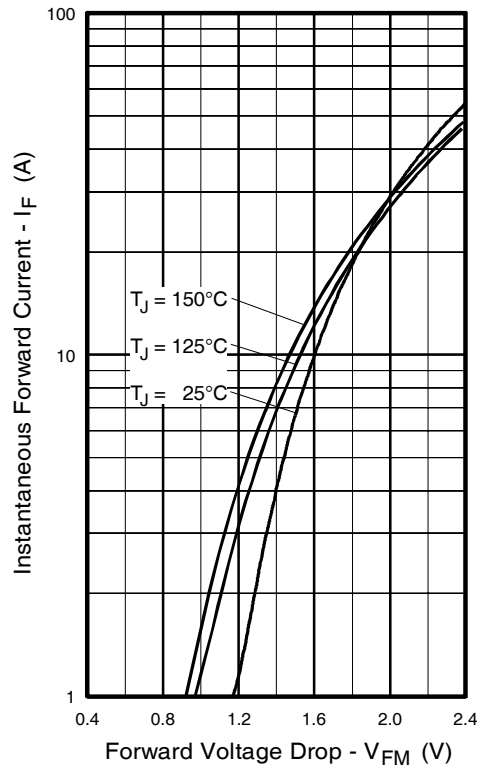

Fig. 13 - Maximum Forward Voltage Drop vs. Instantaneous Forward Current

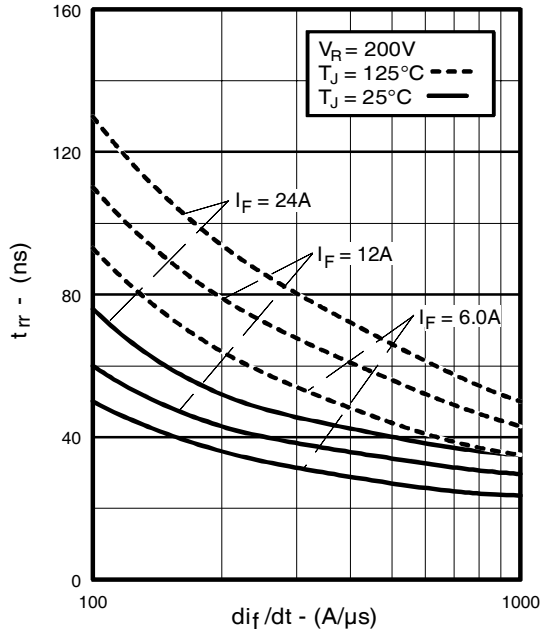

Fig. 14 - Typical Reverse Recovery vs. di_f/dt

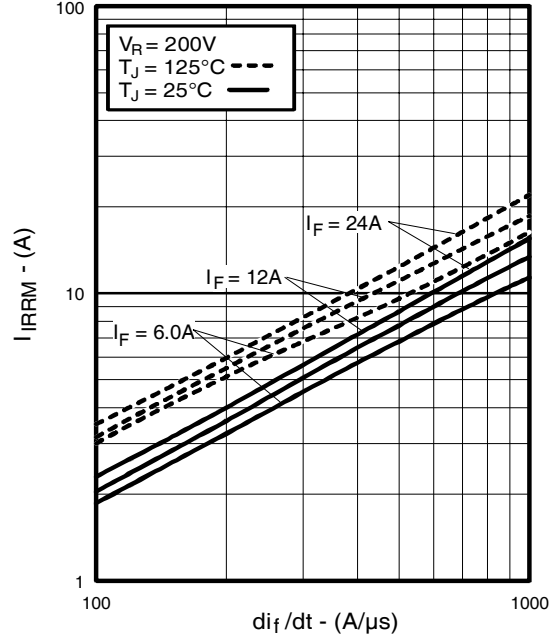

Fig. 15 - Typical Recovery Current vs. di_f/dt

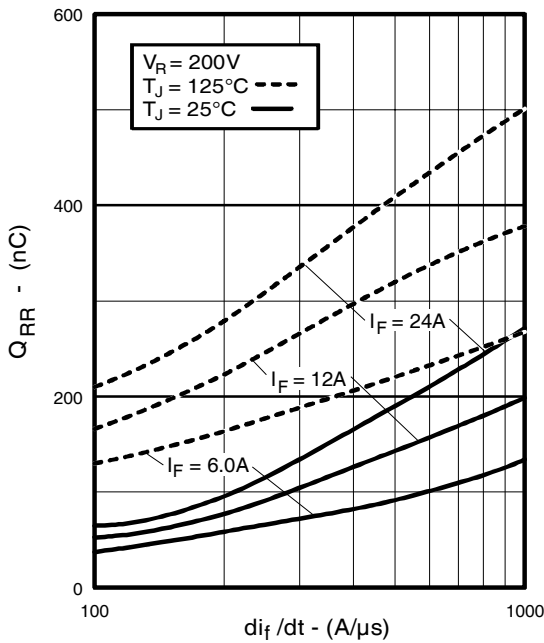

Fig. 16 - Typical Stored Charge vs. di_f/dt

www.irf.com

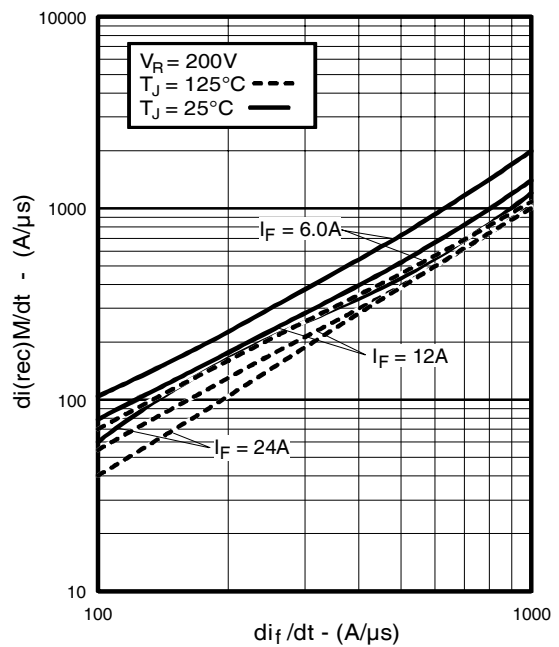

Fig. 17 - Typical $di_{(rec)M}/dt$ vs. di_f/dt

IRG4BC30FDPbF



Fig. 18a - Test Circuit for Measurement of I_{LM} , E_{on} , $E_{off}(\text{diode})$, t_{rr} , Q_{rr} , I_{rr} , $t_{d(on)}$, t_r , $t_{d(off)}$, t_f

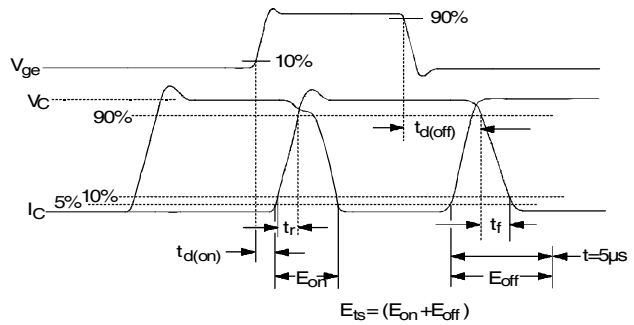

Fig. 18b - Test Waveforms for Circuit of Fig. 18a, Defining E_{off} , $t_{d(off)}$, t_f

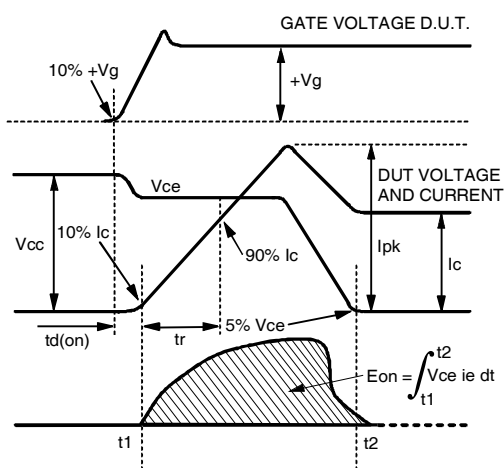

Fig. 18c - Test Waveforms for Circuit of Fig. 18a, Defining E_{on} , $t_{d(on)}$, t_r

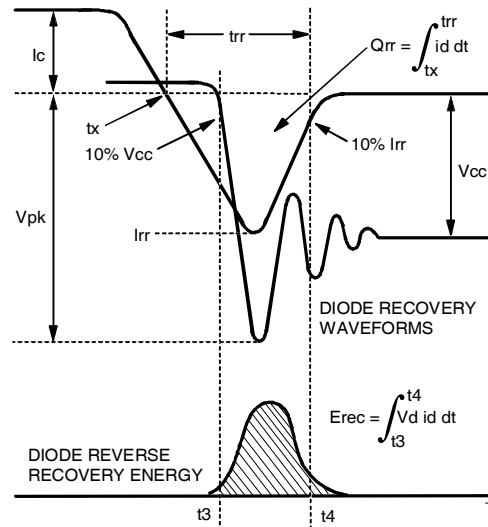

Fig. 18d - Test Waveforms for Circuit of Fig. 18a, Defining E_{rec} , t_{rr} , Q_{rr} , I_{rr}

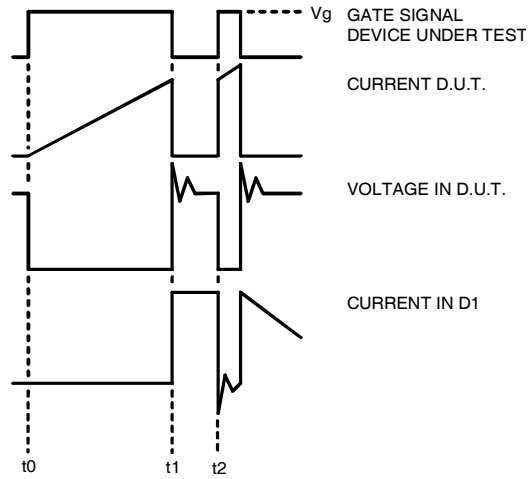

Figure 18e. Macro Waveforms for Figure 18a's Test Circuit

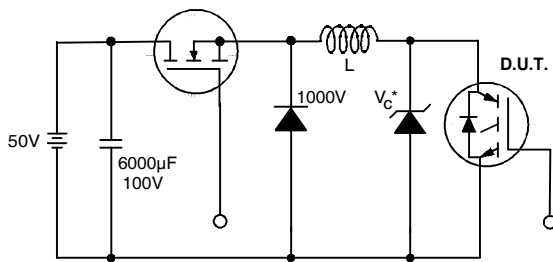
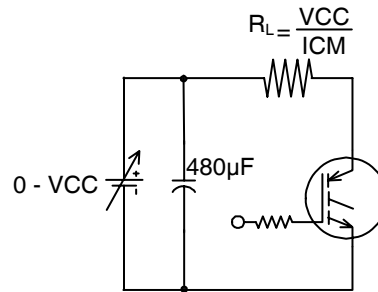

Figure 19. Clamped Inductive Load Test Circuit



Pulsed Collector Current Test Circuit

Figure 20. Pulsed Collector Current Test Circuit

IRG4BC30FDPbF

International
IR Rectifier

TO-220AB Package Outline (Dimensions are shown in millimeters (inches))

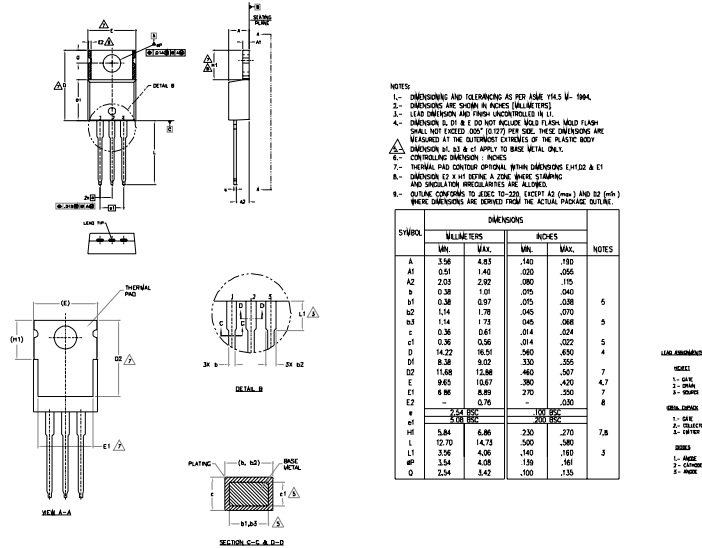

TO-220AB Part Marking Information

EXAMPLE: THIS IS AN IRF1010
 LOT CODE 1789
 ASSEMBLED ON WW 19, 1 1997
 IN THE ASSEMBLY LINE 'C'
Note: "P" in assembly line
 position indicates "Lead-Free"

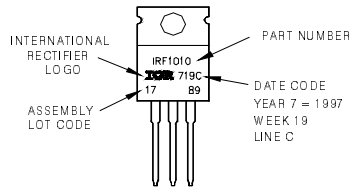

Note: For the most current drawing please refer to IR website at <http://www.irf.com/package/>

Notes:

- ① Repetitive rating: $V_{GE}=20V$; pulse width limited by maximum junction temperature (figure 20)
- ② $V_{CC}=80\%(V_{CES})$, $V_{GE}=20V$, $L=10\mu H$, $R_G = 23\Omega$ (figure 19)
- ③ Pulse width $\leq 80\mu s$; duty factor $\leq 0.1\%$.
- ④ Pulse width $5.0\mu s$, single shot.

Data and specifications subject to change without notice.

International
IR Rectifier

IR WORLD HEADQUARTERS: 233 Kansas St., El Segundo, California 90245, USA Tel: (310) 252-7105
 TAC Fax: (310) 252-7903

Visit us at www.irf.com for sales contact information. 01/2010

www.irf.com

单击下面可查看定价，库存，交付和生命周期等信息

[>>Infineon Technologies\(英飞凌\)](#)