

IRF3710PbF

HEXFET® Power MOSFET

- Advanced Process Technology
- Ultra Low On-Resistance
- Dynamic dv/dt Rating
- 175°C Operating Temperature
- Fast Switching
- Fully Avalanche Rated
- Lead-Free

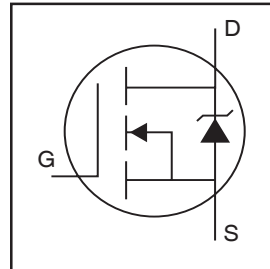

$V_{DSS} = 100V$
$R_{DS(on)} = 23m\Omega$
$I_D = 57A$

Description

Advanced HEXFET® Power MOSFETs from International Rectifier utilize advanced processing techniques to achieve extremely low on-resistance per silicon area. This benefit, combined with the fast switching speed and ruggedized device design that HEXFET power MOSFETs are well known for, provides the designer with an extremely efficient and reliable device for use in a wide variety of applications.

The TO-220 package is universally preferred for all commercial-industrial applications at power dissipation levels to approximately 50 watts. The low thermal resistance and low package cost of the TO-220 contribute to its wide acceptance throughout the industry.

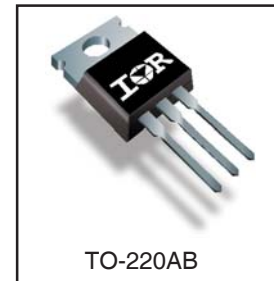

Absolute Maximum Ratings

	Parameter	Max.	Units
$I_D @ T_C = 25^\circ C$	Continuous Drain Current, $V_{GS} @ 10V$	57	A
$I_D @ T_C = 100^\circ C$	Continuous Drain Current, $V_{GS} @ 10V$	40	
I_{DM}	Pulsed Drain Current ①	180	
$P_D @ T_C = 25^\circ C$	Power Dissipation	200	W
	Linear Derating Factor	1.3	W/°C
V_{GS}	Gate-to-Source Voltage	± 20	V
I_{AR}	Avalanche Current ②	28	A
E_{AR}	Repetitive Avalanche Energy ②	20	mJ
dv/dt	Peak Diode Recovery dv/dt ③	5.8	V/ns
T_J	Operating Junction and Storage Temperature Range	-55 to + 175	°C
T_{STG}			
	Mounting torque, 6-32 or M3 screw	10 lbf•in (1.1N•m)	

Thermal Resistance

	Parameter	Typ.	Max.	Units
$R_{\theta JC}$	Junction-to-Case	—	0.75	°C/W
$R_{\theta CS}$	Case-to-Sink, Flat, Greased Surface	0.50	—	
$R_{\theta JA}$	Junction-to-Ambient	—	62	

Electrical Characteristics @ T_J = 25°C (unless otherwise specified)

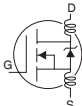
	Parameter	Min.	Typ.	Max.	Units	Conditions
V _{(BR)DSS}	Drain-to-Source Breakdown Voltage	100	—	—	V	V _{GS} = 0V, I _D = 250μA
ΔV _{(BR)DSS} /ΔT _J	Breakdown Voltage Temp. Coefficient	—	0.13	—	V/°C	Reference to 25°C, I _D = 1mA
R _{DS(on)}	Static Drain-to-Source On-Resistance	—	—	23	mΩ	V _{GS} = 10V, I _D = 28A ④
V _{GS(th)}	Gate Threshold Voltage	2.0	—	4.0	V	V _{DS} = V _{GS} , I _D = 250μA
g _{fs}	Forward Transconductance	32	—	—	S	V _{DS} = 25V, I _D = 28A④
I _{DSS}	Drain-to-Source Leakage Current	—	—	25	μA	V _{DS} = 100V, V _{GS} = 0V
		—	—	250		V _{DS} = 80V, V _{GS} = 0V, T _J = 150°C
I _{GSS}	Gate-to-Source Forward Leakage	—	—	100	nA	V _{GS} = 20V
	Gate-to-Source Reverse Leakage	—	—	-100		V _{GS} = -20V
Q _g	Total Gate Charge	—	—	130	nC	I _D = 28A
Q _{gs}	Gate-to-Source Charge	—	—	26		V _{DS} = 80V
Q _{gd}	Gate-to-Drain ("Miller") Charge	—	—	43		V _{GS} = 10V, See Fig. 6 and 13
t _{d(on)}	Turn-On Delay Time	—	12	—	ns	V _{DD} = 50V
t _r	Rise Time	—	58	—		I _D = 28A
t _{d(off)}	Turn-Off Delay Time	—	45	—		R _G = 2.5Ω
t _f	Fall Time	—	47	—		V _{GS} = 10V, See Fig. 10 ④
L _D	Internal Drain Inductance	—	4.5	—	nH	Between lead, 6mm (0.25in.) from package and center of die contact
L _S	Internal Source Inductance	—	7.5	—		
C _{iss}	Input Capacitance	—	3130	—	pF	V _{GS} = 0V
C _{oss}	Output Capacitance	—	410	—		V _{DS} = 25V
C _{rss}	Reverse Transfer Capacitance	—	72	—		f = 1.0MHz, See Fig. 5
E _{AS}	Single Pulse Avalanche Energy②	—	1060③	280⑥		mJ

Source-Drain Ratings and Characteristics

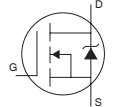
	Parameter	Min.	Typ.	Max.	Units	Conditions
I _S	Continuous Source Current (Body Diode)	—	—	57	A	MOSFET symbol showing the integral reverse p-n junction diode. 
I _{SM}	Pulsed Source Current (Body Diode)①	—	—	230		
V _{SD}	Diode Forward Voltage	—	—	1.2	V	T _J = 25°C, I _S = 28A, V _{GS} = 0V ④
t _{rr}	Reverse Recovery Time	—	140	220	ns	T _J = 25°C, I _F = 28A
Q _{rr}	Reverse Recovery Charge	—	670	1010	nC	di/dt = 100A/μs ④
t _{on}	Forward Turn-On Time	Intrinsic turn-on time is negligible (turn-on is dominated by L _S +L _D)				

Notes:

- ① Repetitive rating; pulse width limited by max. junction temperature. (See fig. 11)
- ② Starting T_J = 25°C, L = 0.70mH
R_G = 25Ω, I_{AS} = 28A, V_{GS} = 10V (See Figure 12)
- ③ I_{SD} ≤ 28A, di/dt ≤ 380A/μs, V_{DD} ≤ V_{(BR)DSS},
T_J ≤ 175°C
- ④ Pulse width ≤ 400μs; duty cycle ≤ 2%.
- ⑤ This is a typical value at device destruction and represents operation outside rated limits.
- ⑥ This is a calculated value limited to T_J = 175°C .

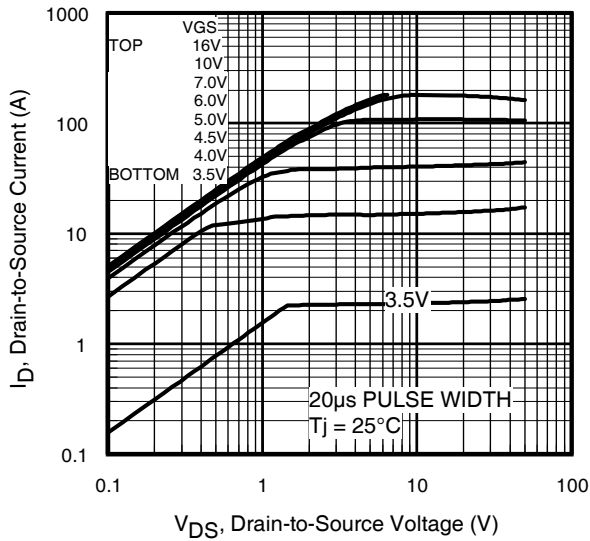

Fig 1. Typical Output Characteristics

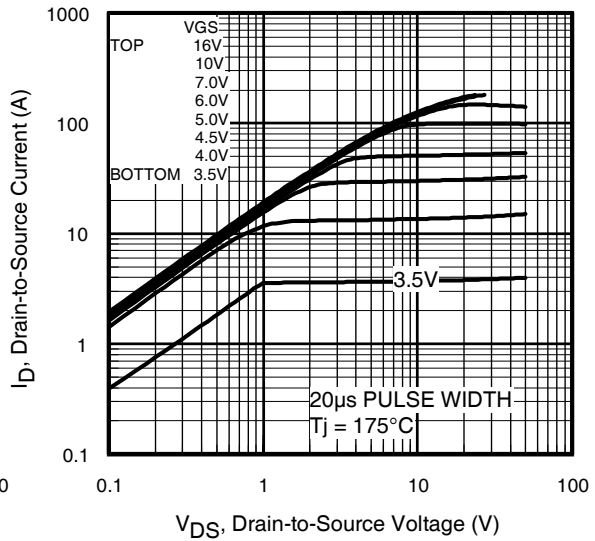

Fig 2. Typical Output Characteristics

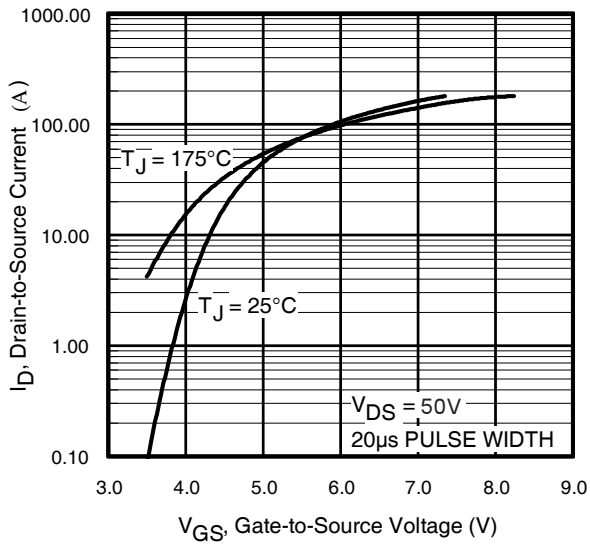

Fig 3. Typical Transfer Characteristics

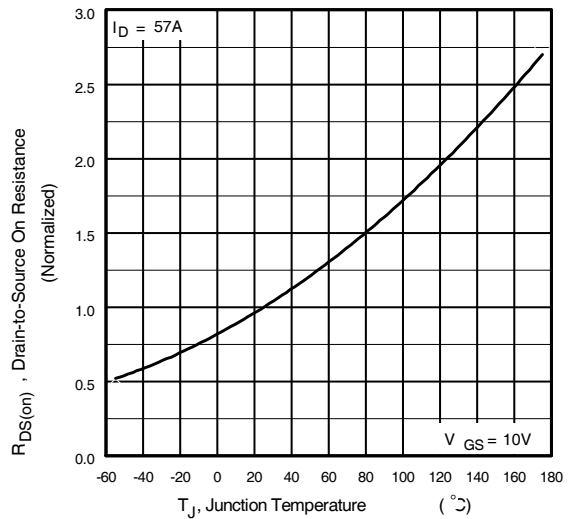

Fig 4. Normalized On-Resistance Vs. Temperature

IRF3710PbF

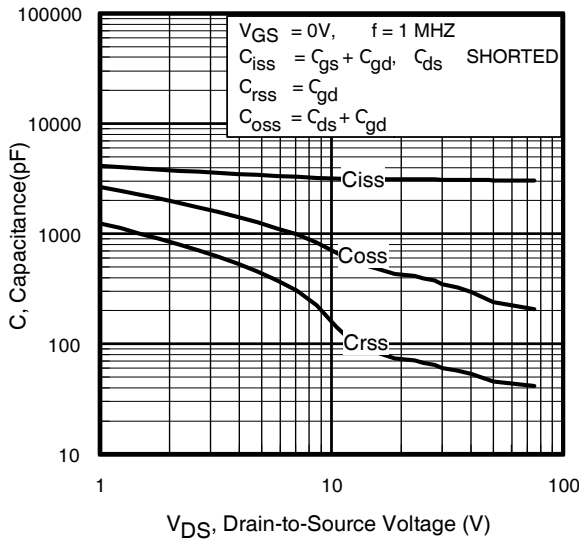

Fig 5. Typical Capacitance Vs. Drain-to-Source Voltage

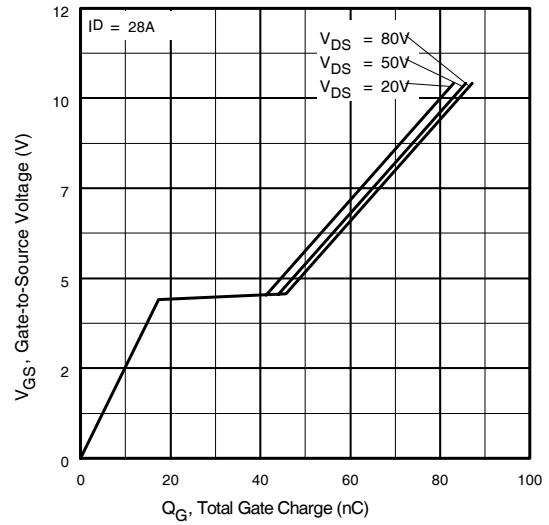

Fig 6. Typical Gate Charge Vs. Gate-to-Source Voltage

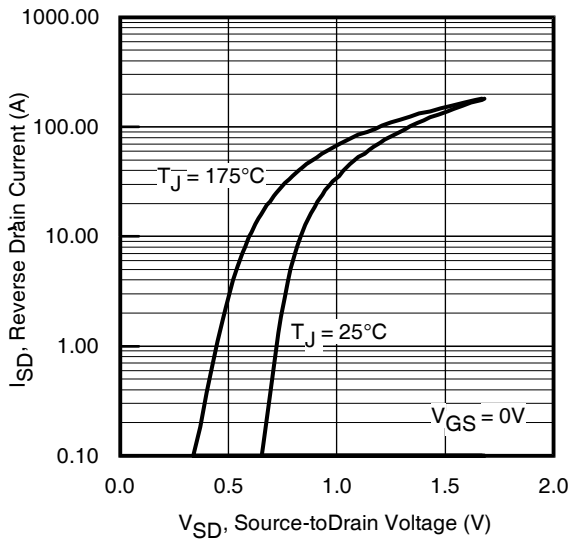

Fig 7. Typical Source-Drain Diode Forward Voltage

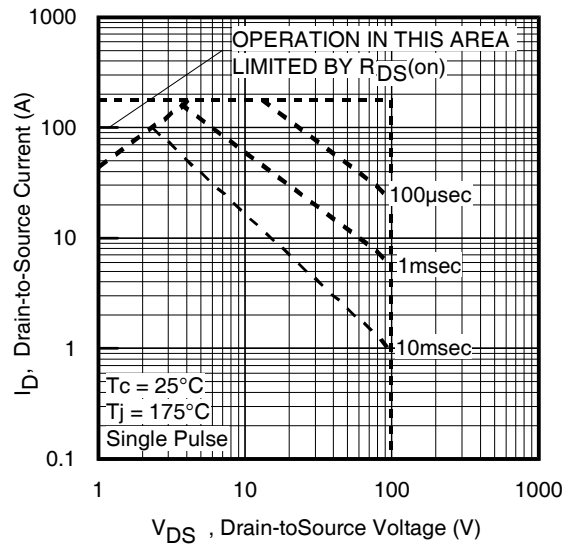

Fig 8. Maximum Safe Operating Area

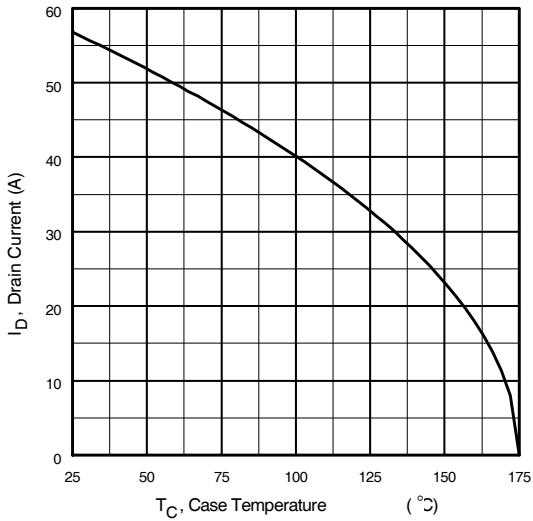

Fig 9. Maximum Drain Current Vs. Case Temperature

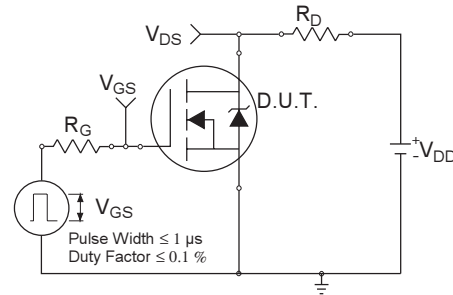

Fig 10a. Switching Time Test Circuit



Fig 10b. Switching Time Waveforms

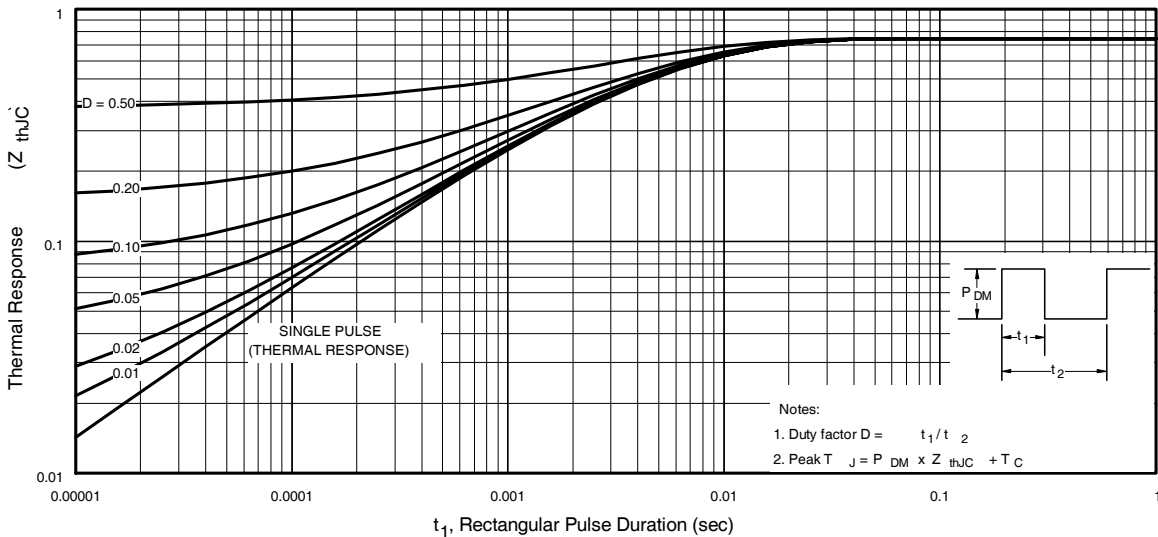

Fig 11. Maximum Effective Transient Thermal Impedance, Junction-to-Case

IRF3710PbF

International
IR Rectifier

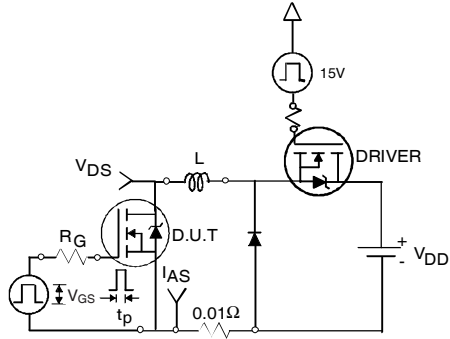

Fig 12a. Unclamped Inductive Test Circuit

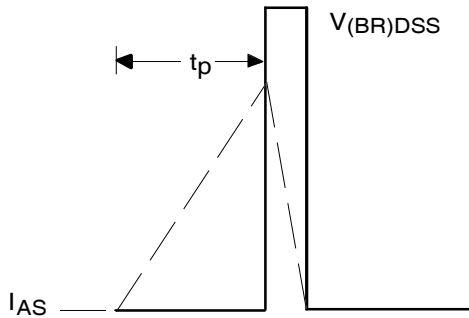

Fig 12b. Unclamped Inductive Waveforms

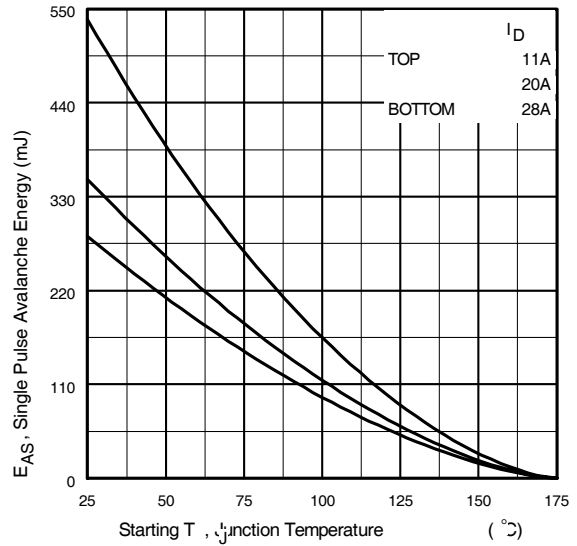

Fig 12c. Maximum Avalanche Energy Vs. Drain Current

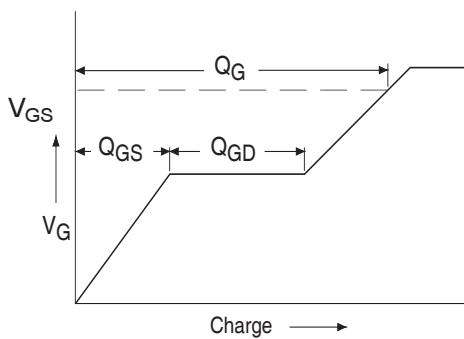

Fig 13a. Basic Gate Charge Waveform

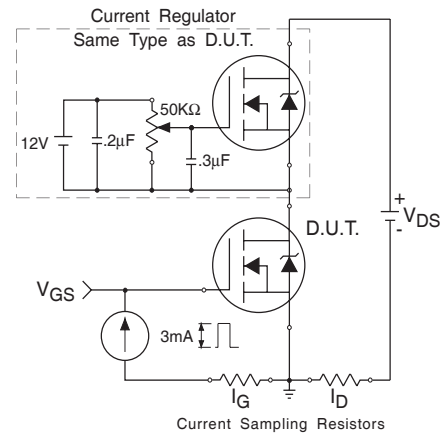
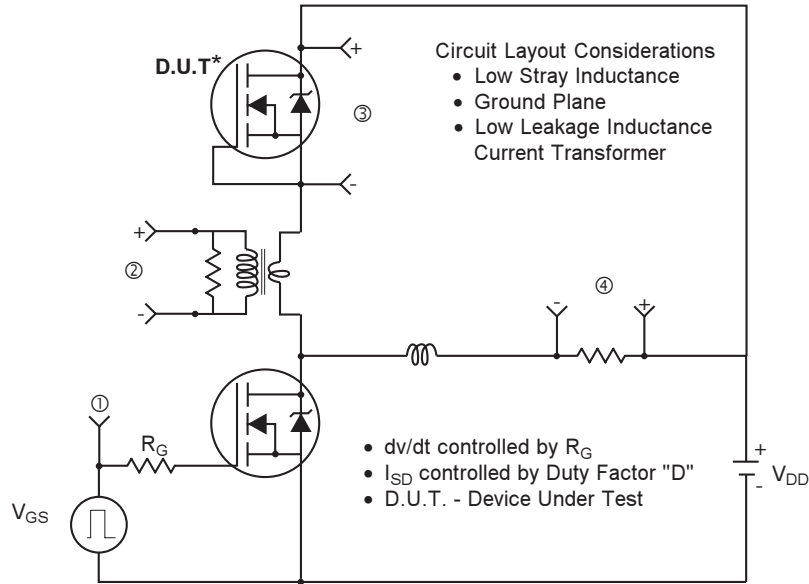
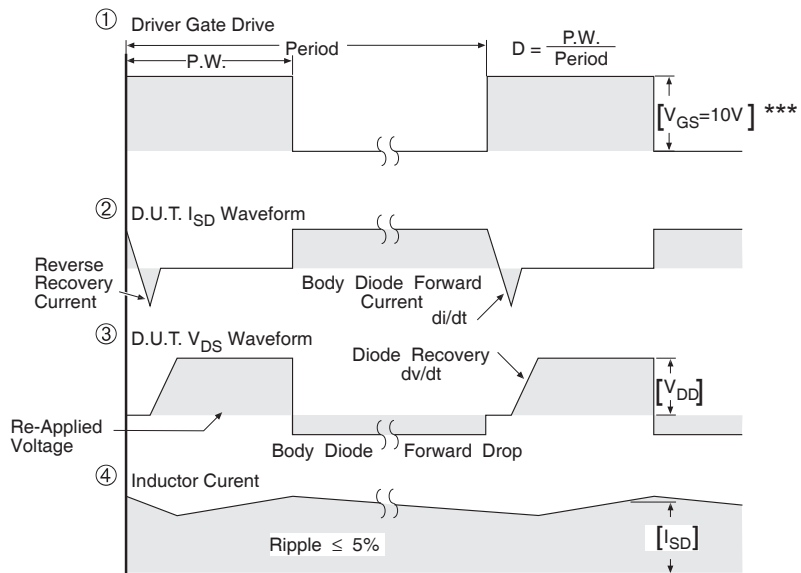

Fig 13b. Gate Charge Test Circuit

Peak Diode Recovery dv/dt Test Circuit



* Reverse Polarity of D.U.T for P-Channel



*** $V_{GS} = 5.0V$ for Logic Level and 3V Drive Devices

Fig 14. For N-channel HEXFET® power MOSFETs

IRF3710PbF

International
IR Rectifier

TO-220AB Package Outline

Dimensions are shown in millimeters (inches)

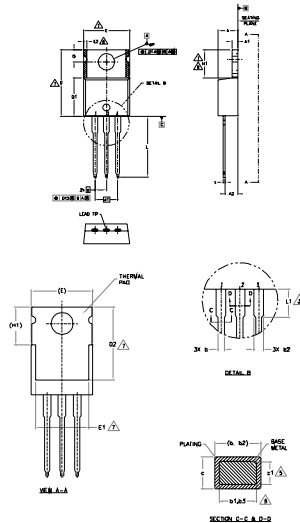

- NOTES:
1. DIMENSIONS AND TOLERANCES ARE FOR ASSEMBLY TO IRF 1000
 2. DIMENSIONS ARE SHOWN IN INCHES (MILLIMETERS)
 3. LEAD DIMENSION SHOWN FROM UNDERMOUNTED TO 1.
 4. DIMENSIONS D, D1, E, E1 DO NOT INCLUDE MOLD FLASH, MOLD FLASH SHALL NOT FACED 90° BECAUSE THESE DIMENSIONS ARE MEASURED AT THE OUTERMOST EXTREMES OF THE PLASTIC BODY
 5. DIMENSION H IS ONLY TO BASE METAL ONLY.
 6. CONTROLLING DIMENSION - INCHES
 7. THERMAL PAD CONTROL OPTION (WHEN DIMENSIONS C, D, D1 & E1)
 8. DIMENSION D2 IS FOR DETAIL B, DIMENSION D2 SHALL BE MEASURED TO THE CENTER OF THE THERMAL PAD. DIMENSIONS D, D1, E, E1, H, H1, H2, H3, H4, H5, H6, H7, H8, H9, H10, H11, H12, H13, H14, H15, H16, H17, H18, H19, H20, H21, H22, H23, H24, H25, H26, H27, H28, H29, H30, H31, H32, H33, H34, H35, H36, H37, H38, H39, H40, H41, H42, H43, H44, H45, H46, H47, H48, H49, H50, H51, H52, H53, H54, H55, H56, H57, H58, H59, H60, H61, H62, H63, H64, H65, H66, H67, H68, H69, H70, H71, H72, H73, H74, H75, H76, H77, H78, H79, H80, H81, H82, H83, H84, H85, H86, H87, H88, H89, H90, H91, H92, H93, H94, H95, H96, H97, H98, H99, H100, H101, H102, H103, H104, H105, H106, H107, H108, H109, H110, H111, H112, H113, H114, H115, H116, H117, H118, H119, H120, H121, H122, H123, H124, H125, H126, H127, H128, H129, H130, H131, H132, H133, H134, H135, H136, H137, H138, H139, H140, H141, H142, H143, H144, H145, H146, H147, H148, H149, H150, H151, H152, H153, H154, H155, H156, H157, H158, H159, H160, H161, H162, H163, H164, H165, H166, H167, H168, H169, H170, H171, H172, H173, H174, H175, H176, H177, H178, H179, H180, H181, H182, H183, H184, H185, H186, H187, H188, H189, H190, H191, H192, H193, H194, H195, H196, H197, H198, H199, H200, H201, H202, H203, H204, H205, H206, H207, H208, H209, H210, H211, H212, H213, H214, H215, H216, H217, H218, H219, H220, H221, H222, H223, H224, H225, H226, H227, H228, H229, H230, H231, H232, H233, H234, H235, H236, H237, H238, H239, H240, H241, H242, H243, H244, H245, H246, H247, H248, H249, H250, H251, H252, H253, H254, H255, H256, H257, H258, H259, H260, H261, H262, H263, H264, H265, H266, H267, H268, H269, H270, H271, H272, H273, H274, H275, H276, H277, H278, H279, H280, H281, H282, H283, H284, H285, H286, H287, H288, H289, H290, H291, H292, H293, H294, H295, H296, H297, H298, H299, H300, H301, H302, H303, H304, H305, H306, H307, H308, H309, H310, H311, H312, H313, H314, H315, H316, H317, H318, H319, H320, H321, H322, H323, H324, H325, H326, H327, H328, H329, H330, H331, H332, H333, H334, H335, H336, H337, H338, H339, H340, H341, H342, H343, H344, H345, H346, H347, H348, H349, H350, H351, H352, H353, H354, H355, H356, H357, H358, H359, H360, H361, H362, H363, H364, H365, H366, H367, H368, H369, H370, H371, H372, H373, H374, H375, H376, H377, H378, H379, H380, H381, H382, H383, H384, H385, H386, H387, H388, H389, H390, H391, H392, H393, H394, H395, H396, H397, H398, H399, H400, H401, H402, H403, H404, H405, H406, H407, H408, H409, H410, H411, H412, H413, H414, H415, H416, H417, H418, H419, H420, H421, H422, H423, H424, H425, H426, H427, H428, H429, H430, H431, H432, H433, H434, H435, H436, H437, H438, H439, H440, H441, H442, H443, H444, H445, H446, H447, H448, H449, H450, H451, H452, H453, H454, H455, H456, H457, H458, H459, H460, H461, H462, H463, H464, H465, H466, H467, H468, H469, H470, H471, H472, H473, H474, H475, H476, H477, H478, H479, H480, H481, H482, H483, H484, H485, H486, H487, H488, H489, H490, H491, H492, H493, H494, H495, H496, H497, H498, H499, H500, H501, H502, H503, H504, H505, H506, H507, H508, H509, H510, H511, H512, H513, H514, H515, H516, H517, H518, H519, H520, H521, H522, H523, H524, H525, H526, H527, H528, H529, H530, H531, H532, H533, H534, H535, H536, H537, H538, H539, H540, H541, H542, H543, H544, H545, H546, H547, H548, H549, H550, H551, H552, H553, H554, H555, H556, H557, H558, H559, H560, H561, H562, H563, H564, H565, H566, H567, H568, H569, H570, H571, H572, H573, H574, H575, H576, H577, H578, H579, H580, H581, H582, H583, H584, H585, H586, H587, H588, H589, H590, H591, H592, H593, H594, H595, H596, H597, H598, H599, H600, H601, H602, H603, H604, H605, H606, H607, H608, H609, H610, H611, H612, H613, H614, H615, H616, H617, H618, H619, H620, H621, H622, H623, H624, H625, H626, H627, H628, H629, H630, H631, H632, H633, H634, H635, H636, H637, H638, H639, H640, H641, H642, H643, H644, H645, H646, H647, H648, H649, H650, H651, H652, H653, H654, H655, H656, H657, H658, H659, H660, H661, H662, H663, H664, H665, H666, H667, H668, H669, H670, H671, H672, H673, H674, H675, H676, H677, H678, H679, H680, H681, H682, H683, H684, H685, H686, H687, H688, H689, H690, H691, H692, H693, H694, H695, H696, H697, H698, H699, H700, H701, H702, H703, H704, H705, H706, H707, H708, H709, H710, H711, H712, H713, H714, H715, H716, H717, H718, H719, H720, H721, H722, H723, H724, H725, H726, H727, H728, H729, H730, H731, H732, H733, H734, H735, H736, H737, H738, H739, H740, H741, H742, H743, H744, H745, H746, H747, H748, H749, H750, H751, H752, H753, H754, H755, H756, H757, H758, H759, H760, H761, H762, H763, H764, H765, H766, H767, H768, H769, H770, H771, H772, H773, H774, H775, H776, H777, H778, H779, H780, H781, H782, H783, H784, H785, H786, H787, H788, H789, H790, H791, H792, H793, H794, H795, H796, H797, H798, H799, H800, H801, H802, H803, H804, H805, H806, H807, H808, H809, H810, H811, H812, H813, H814, H815, H816, H817, H818, H819, H820, H821, H822, H823, H824, H825, H826, H827, H828, H829, H830, H831, H832, H833, H834, H835, H836, H837, H838, H839, H840, H841, H842, H843, H844, H845, H846, H847, H848, H849, H850, H851, H852, H853, H854, H855, H856, H857, H858, H859, H860, H861, H862, H863, H864, H865, H866, H867, H868, H869, H870, H871, H872, H873, H874, H875, H876, H877, H878, H879, H880, H881, H882, H883, H884, H885, H886, H887, H888, H889, H890, H891, H892, H893, H894, H895, H896, H897, H898, H899, H900, H901, H902, H903, H904, H905, H906, H907, H908, H909, H910, H911, H912, H913, H914, H915, H916, H917, H918, H919, H920, H921, H922, H923, H924, H925, H926, H927, H928, H929, H930, H931, H932, H933, H934, H935, H936, H937, H938, H939, H940, H941, H942, H943, H944, H945, H946, H947, H948, H949, H950, H951, H952, H953, H954, H955, H956, H957, H958, H959, H960, H961, H962, H963, H964, H965, H966, H967, H968, H969, H970, H971, H972, H973, H974, H975, H976, H977, H978, H979, H980, H981, H982, H983, H984, H985, H986, H987, H988, H989, H990, H991, H992, H993, H994, H995, H996, H997, H998, H999, H1000.

SYMBOL	DIMENSIONS				NOTES
	MILLIMETERS		INCHES		
A	3.56	4.83	.140	.190	
A1	0.51	1.40	.020	.055	
A2	2.03	2.82	.080	.110	
h	0.38	1.01	.015	.040	
h1	0.38	0.97	.015	.038	5
h2	1.14	1.78	.045	.070	
h3	1.14	1.73	.045	.068	5
l	0.36	0.81	.014	.031	
c1	0.36	0.56	.014	.022	5
D	14.22	16.51	.560	.650	4
D1	8.38	9.52	.330	.375	
D2	11.48	12.86	.450	.507	7
E	8.83	10.87	.350	.425	4, 7
E1	8.86	8.89	.350	.350	7
E2	-	0.76	-	.030	8
h	2.54	101.91	.100	4.010	
h1	0.54	8.89	.021	.350	7, 8
h2	12.70	14.73	.500	.580	
E1	3.56	4.06	.140	.160	3
h1	1.54	4.06	.061	.161	
Q	2.54	3.42	.100	.135	

- UNIT CONVERSIONS
- 1" = 25.4 mm
 - 1 mm = 0.03937"
- SYMBOLS
- 1 - DIM
 - 2 - DIM
 - 3 - DIM
- SYMBOLS
- 1 - DIM
 - 2 - DIM
 - 3 - DIM

TO-220AB Part Marking Information

EXAMPLE: THIS IS AN IRF1010
LOT CODE 1789
ASSEMBLED ON WW 19, 2000
IN THE ASSEMBLY LINE "C"

Note: "P" in assembly line position indicates "Lead-Free"

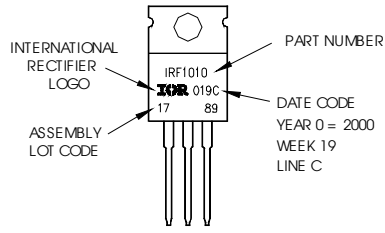

TO-220AB package is not recommended for Surface Mount Application

- Notes:
1. For an Automotive Qualified version of this part please see <http://www.irf.com/product-info/auto/>
 2. For the most current drawing please refer to IR website at <http://www.irf.com/package/>

Data and specifications subject to change without notice.
This product has been designed and qualified for the Industrial market.
Qualification Standards can be found on IR's Web site.

International
IR Rectifier

IR WORLD HEADQUARTERS: 233 Kansas St., El Segundo, California 90245, USA Tel: (310) 252-7105
TAC Fax: (310) 252-7903
Visit us at www.irf.com for sales contact information.07/2010
www.irf.com

单击下面可查看定价，库存，交付和生命周期等信息

[>>Infineon Technologies\(英飞凌\)](#)