

OptiMOS[®]-P Small-Signal-Transistor Feature

- P-Channel
- Enhancement mode
- Logic Level
- 150°C operating temperature
- Avalanche rated
- dv/dt rated
- Pb-free lead plating; RoHS compliant
- Qualified according to AEC Q101
- Halogen free according to IEC61249-2-21



Halogen-Free

Product Summary

V_{DS}	-30	V
$R_{DS(on)}$	43	m Ω
I_D	-5.5	A

PG-TSOP-6-1

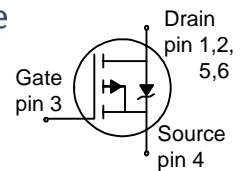
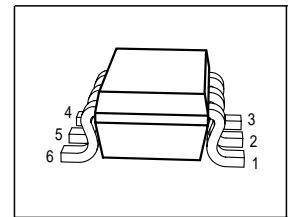

Type	Package	Tape and reel	Marking
BSL307SP	PG-TSOP-6-1	H6327: 3000pcs/r.	sPC

Maximum Ratings, at $T_j = 25^\circ\text{C}$, unless otherwise specified

Parameter	Symbol	Value	Unit
Continuous drain current	I_D		A
$T_A=25^\circ\text{C}$		-5.5	
$T_A=70^\circ\text{C}$		-4.4	
Pulsed drain current	$I_D \text{ puls}$	-22	
$T_A=25^\circ\text{C}$			
Avalanche energy, single pulse	E_{AS}	44	mJ
$I_D=-5.5 \text{ A}$, $V_{DD}=-25\text{V}$, $R_{GS}=25\Omega$			
Reverse diode dv/dt	dv/dt	-6	kV/ μs
$I_S=-5.5\text{A}$, $V_{DS}=24\text{V}$, $dI/dt=200\text{A}/\mu\text{s}$, $T_{jmax}=150^\circ\text{C}$			
Gate source voltage	V_{GS}	± 20	V
Power dissipation	P_{tot}	2	W
$T_A=25^\circ\text{C}$			
Operating and storage temperature	T_j, T_{stg}	-55... +150	$^\circ\text{C}$
IEC climatic category; DIN IEC 68-1		55/150/56	
ESD Class JEDEC22-A114-HBM		Class 1a	

Thermal Characteristics

Parameter	Symbol	Values			Unit
		min.	typ.	max.	
Characteristics					
Thermal resistance, junction - soldering point	R_{thJS}	-	-	50	K/W
SMD version, device on PCB:	R_{thJA}				
@ min. footprint		-	-	230	
@ 6 cm ² cooling area ¹⁾		-	-	62.5	

Electrical Characteristics, at $T_j = 25^\circ\text{C}$, unless otherwise specified

Parameter	Symbol	Values			Unit
		min.	typ.	max.	
Static Characteristics					
Drain-source breakdown voltage $V_{GS}=0, I_D=-250\mu\text{A}$	$V_{(BR)DSS}$	-30	-	-	V
Gate threshold voltage, $V_{GS} = V_{DS}$ $I_D=-40\mu\text{A}$	$V_{GS(th)}$	-1	-1.5	-2	
Zero gate voltage drain current $V_{DS}=-30\text{V}, V_{GS}=0, T_j=25^\circ\text{C}$ $V_{DS}=-30\text{V}, V_{GS}=0, T_j=150^\circ\text{C}$	I_{DSS}	-	-0.1	-1	μA
Gate-source leakage current $V_{GS}=-20\text{V}, V_{DS}=0$	I_{GSS}	-	-10	-100	
Drain-source on-state resistance $V_{GS}=-4.5\text{V}, I_D=-4.2\text{A}$	$R_{DS(on)}$	-	52	74	$\text{m}\Omega$
Drain-source on-state resistance $V_{GS}=-10\text{V}, I_D=-5.5\text{A}$	$R_{DS(on)}$	-	31	43	

¹Device on 40mm*40mm*1.5mm epoxy PCB FR4 with 6cm² (one layer, 70 μm thick) copper area for drain connection. PCB is vertical without blown air; $t \leq 5$ sec.

Electrical Characteristics, at $T_j = 25\text{ }^\circ\text{C}$, unless otherwise specified

Parameter	Symbol	Conditions	Values			Unit
			min.	typ.	max.	

Dynamic Characteristics

Transconductance	g_{fs}	$ V_{DS} \geq 2 * I_D * R_{DS(on)max}$ $I_D = -4.4\text{A}$	4.7	9.4	-	S
Input capacitance	C_{iss}	$V_{GS} = 0, V_{DS} = -25\text{V},$ $f = 1\text{MHz}$	-	805	-	pF
Output capacitance	C_{oss}		-	234	-	
Reverse transfer capacitance	C_{rss}		-	195	-	
Turn-on delay time	$t_{d(on)}$	$V_{DD} = -15\text{V}, V_{GS} = -10\text{V},$ $I_D = -1\text{A}, R_G = 6\Omega$	-	7.3	11	ns
Rise time	t_r		-	8.4	12.6	
Turn-off delay time	$t_{d(off)}$		-	36.4	55	
Fall time	t_f		-	29	44	

Gate Charge Characteristics

Gate to source charge	Q_{gs}	$V_{DD} = -24\text{V}, I_D = -5.5\text{A}$	-	-2	-2.5	nC
Gate to drain charge	Q_{gd}		-	-8.2	-12.3	
Gate charge total	Q_g	$V_{DD} = -24\text{V}, I_D = -5.5\text{A},$ $V_{GS} = 0 \text{ to } -10\text{V}$	-	-23.4	-29	
Gate plateau voltage	$V_{(plateau)}$	$V_{DD} = -24\text{V}, I_D = -5.5\text{A}$	-	-2.8	-	V

Reverse Diode

Inverse diode continuous forward current	I_S	$T_A = 25\text{ }^\circ\text{C}$	-	-	-5.5	A
Inverse diode direct current, pulsed	I_{SM}		-	-	-22	
Inverse diode forward voltage	V_{SD}	$V_{GS} = 0, I_F = I_D $	-	-0.88	-1.3	V
Reverse recovery time	t_{rr}	$V_R = -15\text{V}, I_F = I_D ,$ $di_F/dt = 100\text{A}/\mu\text{s}$	-	16.6	21	ns
Reverse recovery charge	Q_{rr}		-	6.2	7.8	

1 Power dissipation

$$P_{tot} = f(T_A)$$

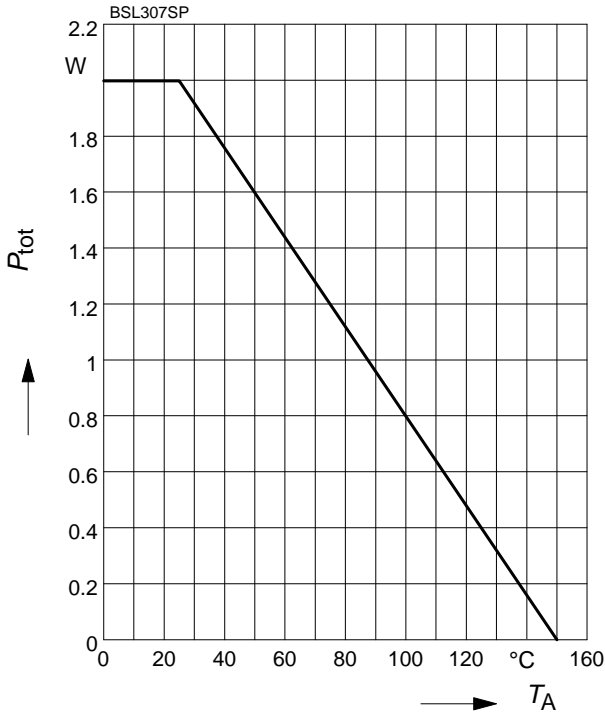

2 Drain current

$$I_D = f(T_A)$$

parameter: $|V_{GS}| \geq 10 \text{ V}$

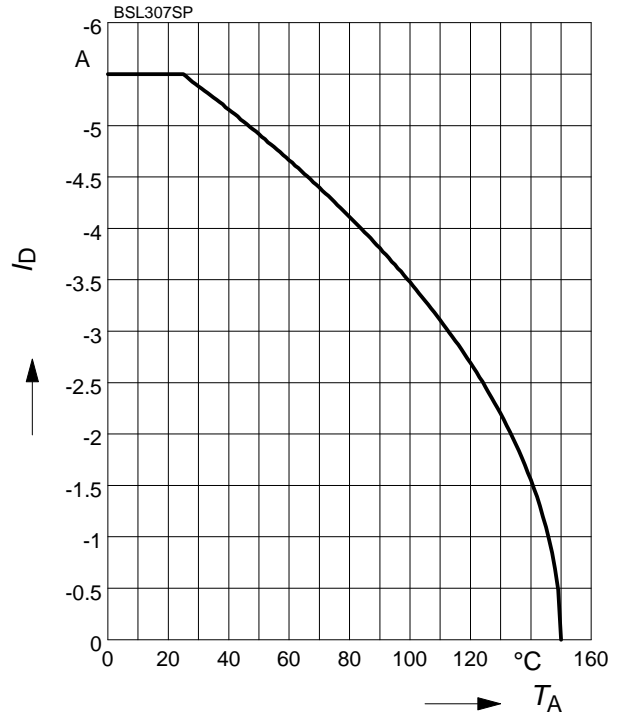

3 Safe operating area

$$I_D = f(V_{DS})$$

parameter: $D = 0, T_A = 25 \text{ °C}$

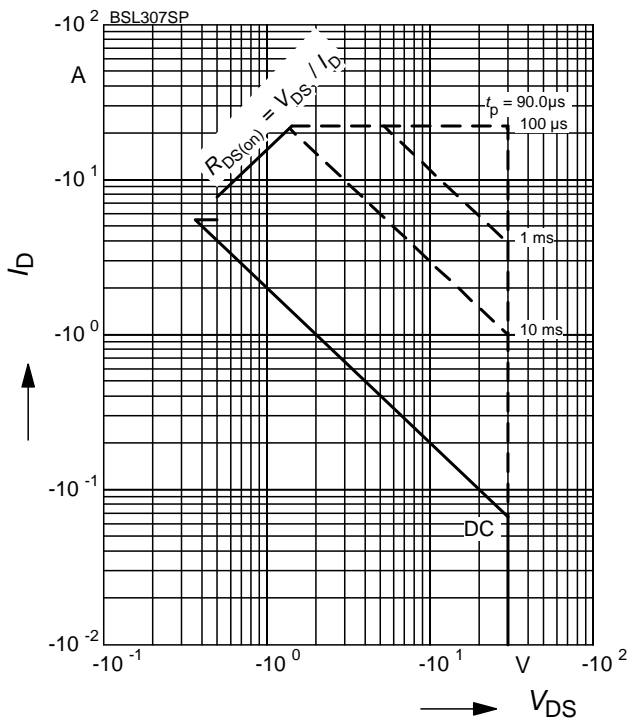

4 Transient thermal impedance

$$Z_{thJS} = f(t_p)$$

parameter: $D = t_p/T$

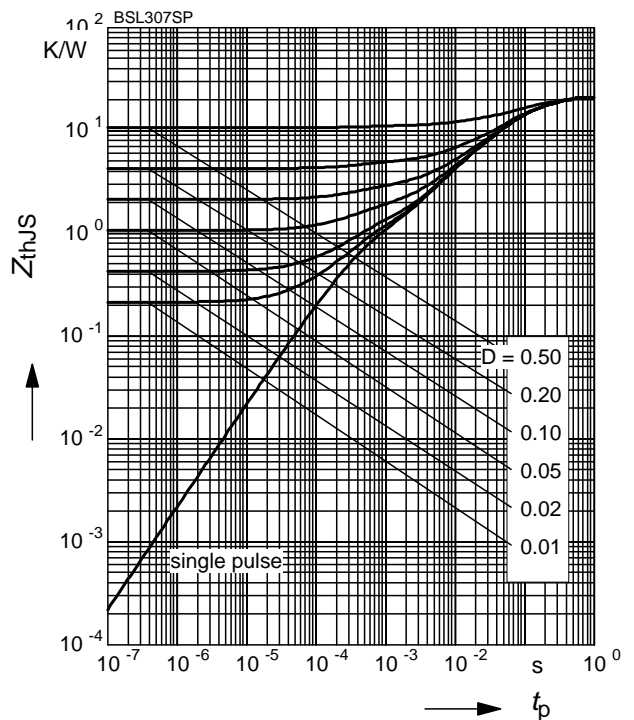

5 Typ. output characteristic

$I_D = f(V_{DS}); T_j = 25^\circ\text{C}$

parameter: $t_p = 80 \mu\text{s}$

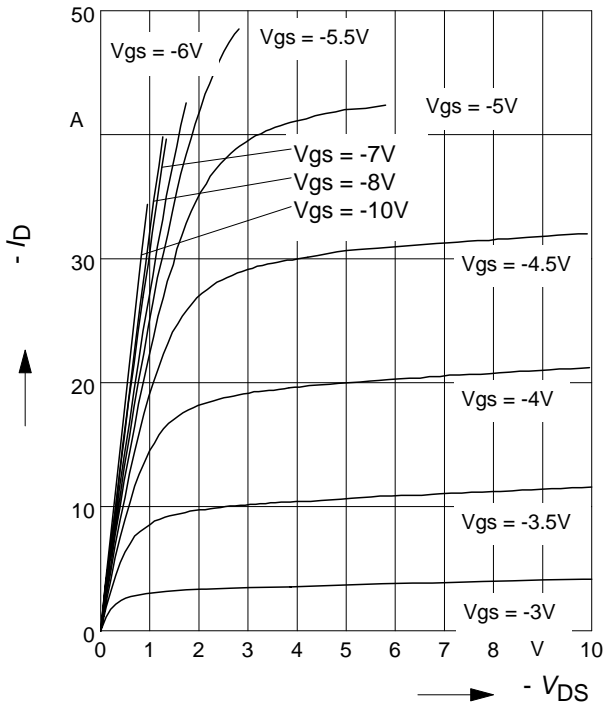

6 Typ. drain-source on resistance

$R_{DS(on)} = f(I_D)$

parameter: V_{GS}

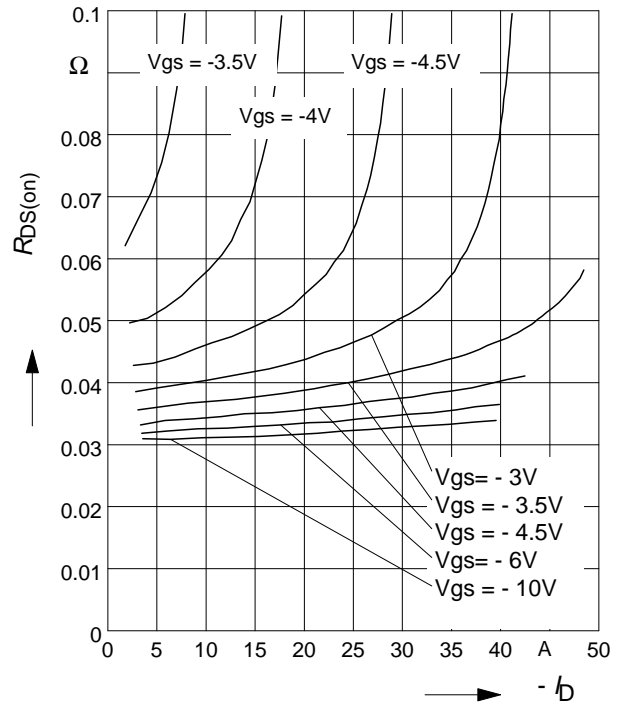

7 Typ. transfer characteristics

$I_D = f(V_{GS}); |V_{DS}| \geq 2 \times |I_D| \times R_{DS(on)max}$

parameter: $t_p = 80 \mu\text{s}$

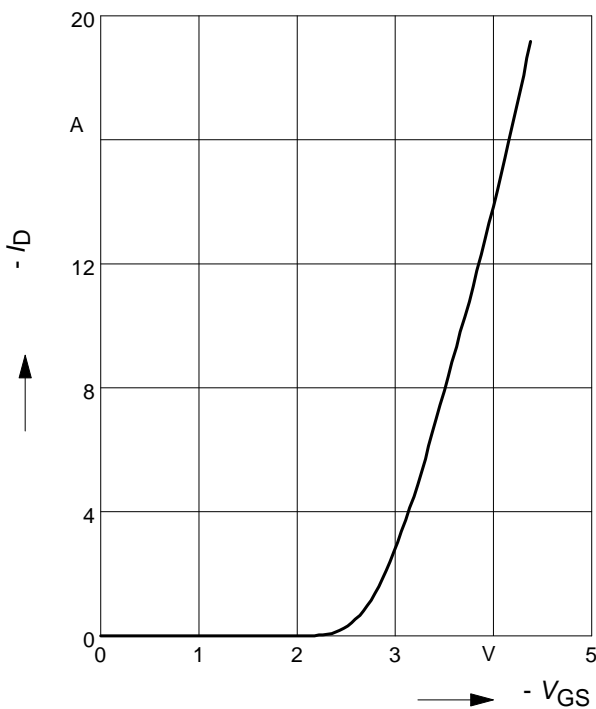

8 Typ. forward transconductance

$g_{fs} = f(I_D); T_j = 25^\circ\text{C}$

parameter: $t_p = 80 \mu\text{s}$

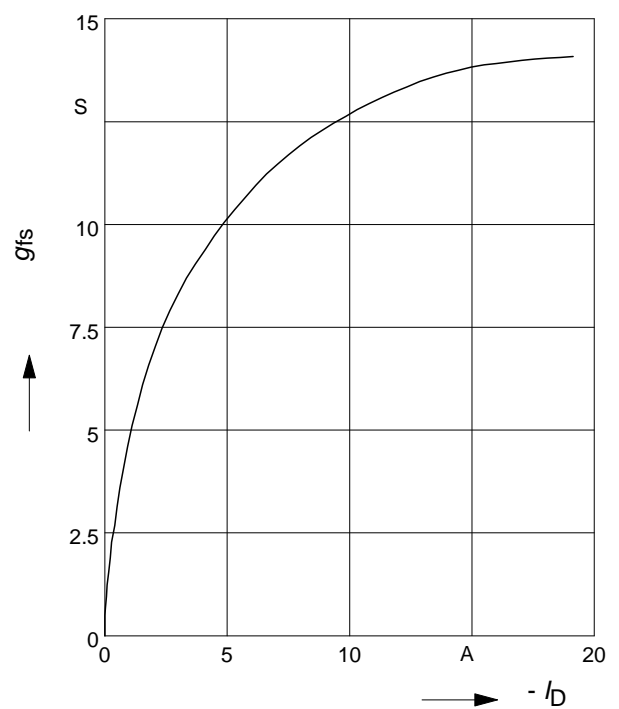

9 Drain-source on-resistance

$$R_{DS(on)} = f(T_j)$$

parameter: $I_D = -5.5 \text{ A}$, $V_{GS} = -10 \text{ V}$

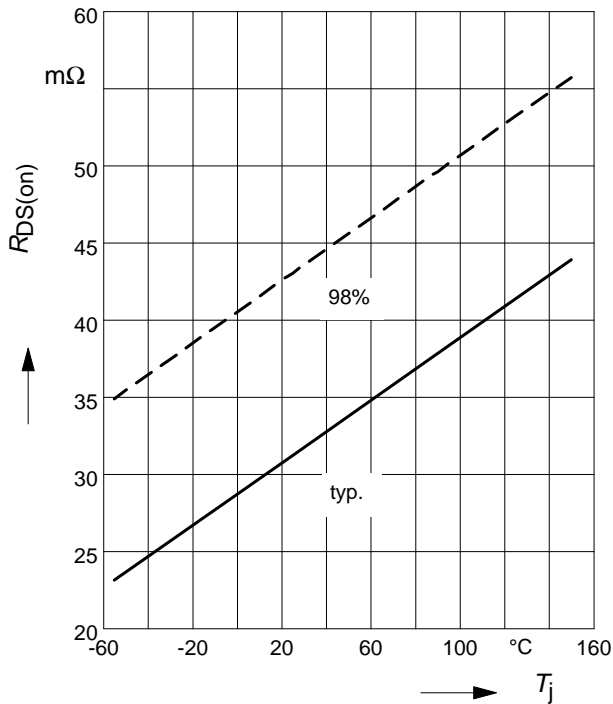

10 Typ. gate threshold voltage

$$V_{GS(th)} = f(T_j)$$

parameter: $V_{GS} = V_{DS}$

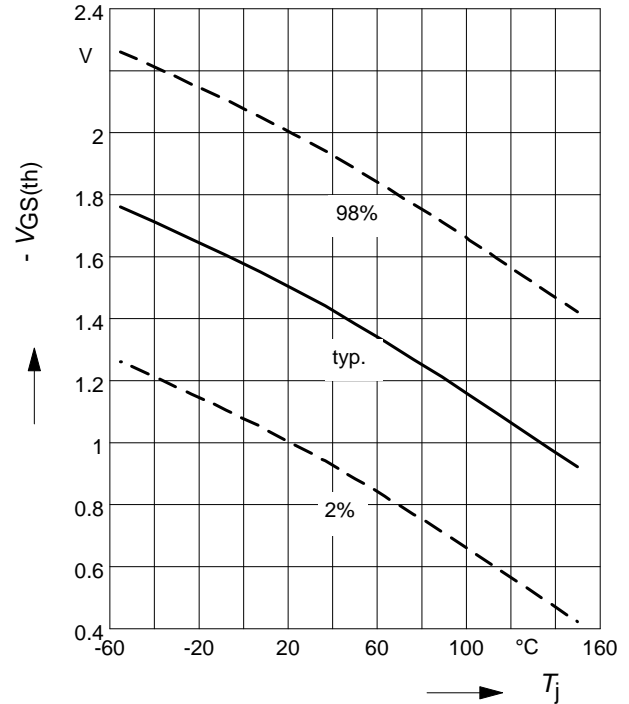

11 Typ. capacitances

$$C = f(V_{DS})$$

parameter: $V_{GS}=0$, $f=1 \text{ MHz}$

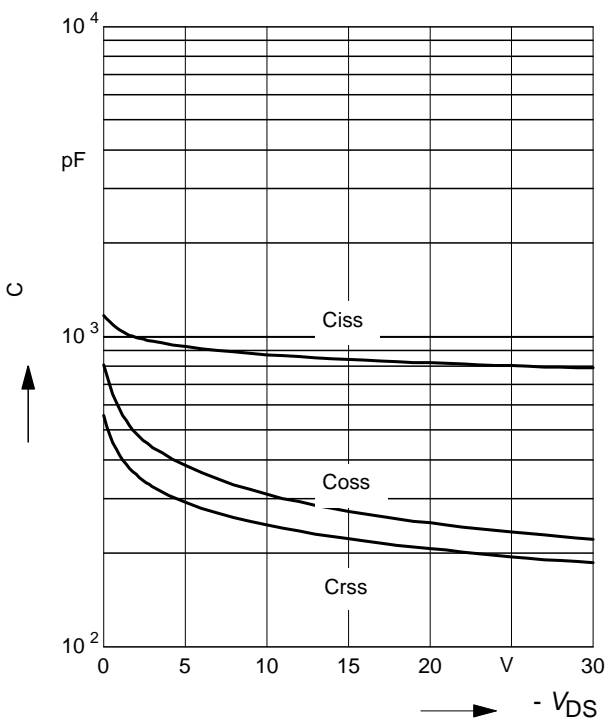

12 Forward character. of reverse diode

$$I_F = f(V_{SD})$$

parameter: T_j , $t_p = 80 \mu\text{s}$

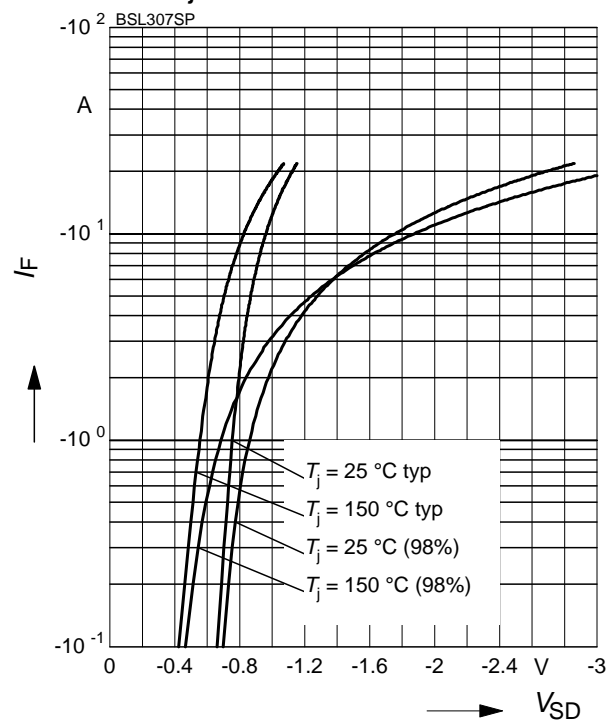

13 Typ. avalanche energy

$E_{AS} = f(T_j)$, par.: $I_D = -5.5 \text{ A}$

$V_{DD} = -25 \text{ V}$, $R_{GS} = 25 \Omega$

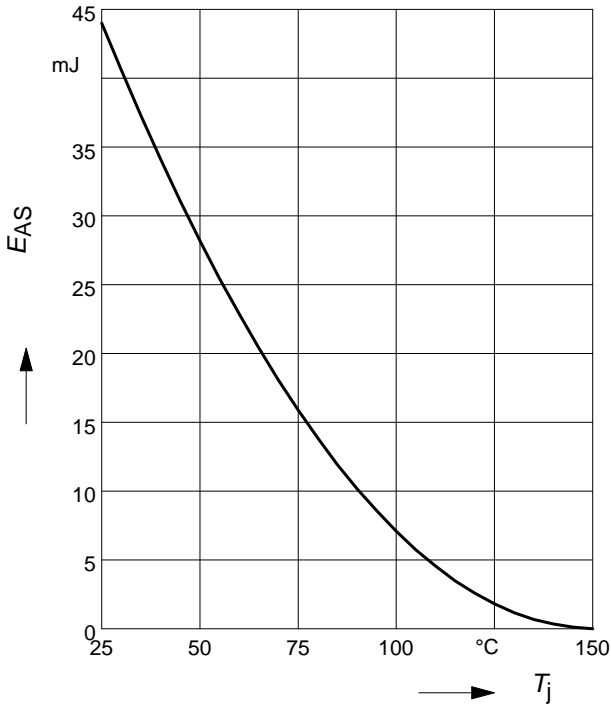

14 Typ. gate charge

$|V_{GS}| = f(Q_{Gate})$

parameter: $I_D = -5.5 \text{ A}$ pulsed

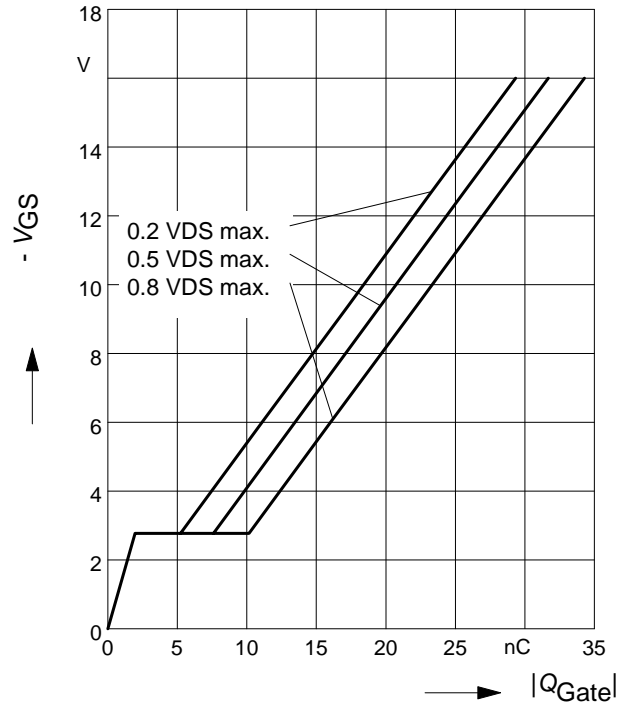

15 Drain-source breakdown voltage

$V_{(BR)DSS} = f(T_j)$

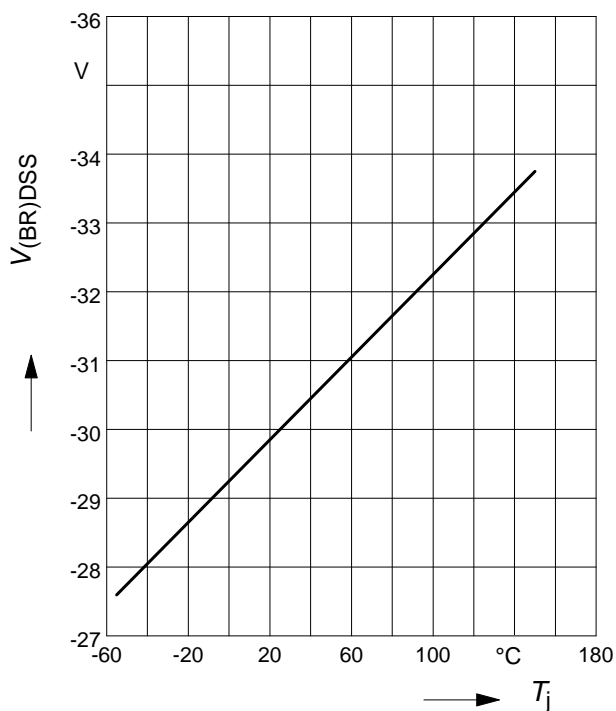

Package Outline:

TSOP6

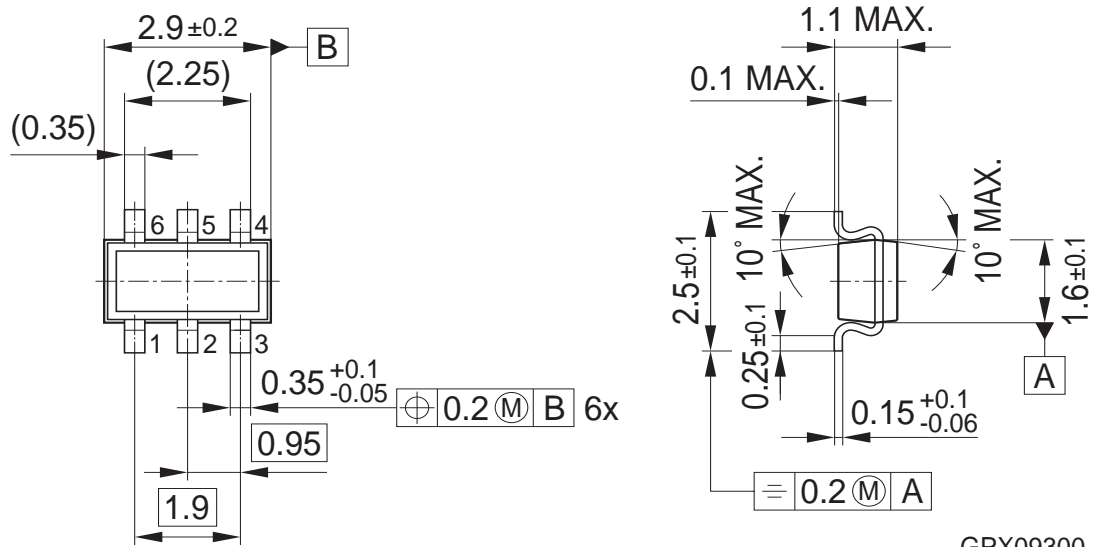

Footprint:

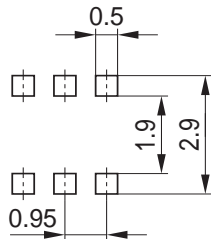

Remark: Wave soldering possible dep. on customers process conditions

HLG09283

Packaging:

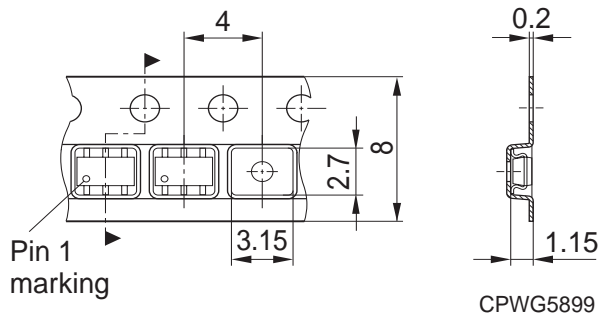

Dimensions in mm

Published by
Infineon Technologies AG
81726 Munich, Germany
© 2009 Infineon Technologies AG
All Rights Reserved.

Legal Disclaimer

The information given in this document shall in no event be regarded as a guarantee of conditions or characteristics. With respect to any examples or hints given herein, any typical values stated herein and/or any information regarding the application of the device, Infineon Technologies hereby disclaims any and all warranties and liabilities of any kind, including without limitation, warranties of non-infringement of intellectual property rights of any third party.

Information

For further information on technology, delivery terms and conditions and prices, please contact the nearest Infineon Technologies Office (www.infineon.com).

Warnings

Due to technical requirements, components may contain dangerous substances. For information on the types in question, please contact the nearest Infineon Technologies Office. Infineon Technologies components may be used in life-support devices or systems only with the express written approval of Infineon Technologies, if a failure of such components can reasonably be expected to cause the failure of that life-support device or system or to affect the safety or effectiveness of that device or system. Life support devices or systems are intended to be implanted in the human body or to support and/or maintain and sustain and/or protect human life. If they fail, it is reasonable to assume that the health of the user or other persons may be endangered.

单击下面可查看定价，库存，交付和生命周期等信息

[>>Infineon Technologies\(英飞凌\)](#)