

## MOSFET

Metal Oxide Semiconductor Field Effect Transistor

## CoolMOS™ P6

600V CoolMOS™ P6 Power Transistor  
IPx60R099P6

## Data Sheet

Rev. 2.1  
Final

## 1 Description

CoolMOS™ is a revolutionary technology for high voltage power MOSFETs, designed according to the superjunction (SJ) principle and pioneered by Infineon Technologies. CoolMOS™ P6 series combines the experience of the leading SJ MOSFET supplier with high class innovation. The offered devices provide all benefits of a fast switching SJ MOSFET while not sacrificing ease of use. Extremely low switching and conduction losses make switching applications even more efficient, more compact, lighter and cooler.

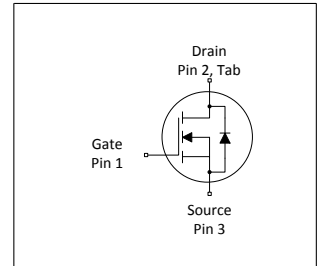
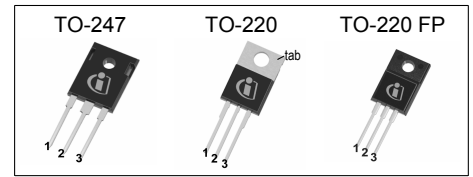

## Features

- Increased MOSFET dv/dt ruggedness
- Extremely low losses due to very low FOM  $R_{DS(on)} \cdot Q_g$  and  $E_{oss}$
- Very high commutation ruggedness
- Easy to use/drive
- Pb-free plating, Halogen free mold compound
- Qualified for industrial grade applications according to JEDEC (J-STD20 and JESD22)



## Applications

PFC stages, hard switching PWM stages and resonant switching stages for e.g. PC Silverbox, Adapter, LCD & PDP TV, Lighting, Server, Telecom and UPS.



*Please note: For MOSFET paralleling the use of ferrite beads on the gate or separate totem poles is generally recommended.*

**Table 1 Key Performance Parameters**

Parameter	Value	Unit
$V_{DS} @ T_{j,max}$	650	V
$R_{DS(on),max}$	99	mΩ
$Q_{g,typ}$	70	nC
$I_{D,pulse}$	109	A
$E_{oss@400V}$	8.8	μJ
Body diode di/dt	300	A/μs

Type / Ordering Code	Package	Marking	Related Links
IPW60R099P6	PG-TO 247	6R099P6	see Appendix A
IPP60R099P6	PG-TO 220		
IPA60R099P6	PG-TO 220 FullPAK		



**Table of Contents**

Description ..... 2

Maximum ratings ..... 4

Thermal characteristics ..... 5

Electrical characteristics ..... 6

Electrical characteristics diagrams ..... 8

Test Circuits ..... 13

Package Outlines ..... 14

Appendix A ..... 17

Revision History ..... 18

Disclaimer ..... 18

## 2 Maximum ratings

at  $T_j = 25^\circ\text{C}$ , unless otherwise specified

**Table 2 Maximum ratings**

Parameter	Symbol	Values			Unit	Note / Test Condition
		Min.	Typ.	Max.		
Continuous drain current <sup>1)</sup>	$I_D$	-	-	37.9 24.0	A	$T_C=25^\circ\text{C}$ $T_C=100^\circ\text{C}$
Pulsed drain current <sup>2)</sup>	$I_{D,pulse}$	-	-	109	A	$T_C=25^\circ\text{C}$
Avalanche energy, single pulse	$E_{AS}$	-	-	796	mJ	$I_D=6.6\text{A}$ ; $V_{DD}=50\text{V}$ ; see table 10
Avalanche energy, repetitive	$E_{AR}$	-	-	1.21	mJ	$I_D=6.6\text{A}$ ; $V_{DD}=50\text{V}$ ; see table 10
Avalanche current, repetitive	$I_{AR}$	-	-	6.6	A	-
MOSFET dv/dt ruggedness	dv/dt	-	-	100	V/ns	$V_{DS}=0\dots400\text{V}$
Gate source voltage (static)	$V_{GS}$	-20	-	20	V	static;
Gate source voltage (dynamic)	$V_{GS}$	-30	-	30	V	AC ( $f>1\text{ Hz}$ )
Power dissipation (Non FullPAK) TO-220, TO-247	$P_{tot}$	-	-	278	W	$T_C=25^\circ\text{C}$
Power dissipation (FullPAK) TO-220FP	$P_{tot}$	-	-	34	W	$T_C=25^\circ\text{C}$
Storage temperature	$T_{stg}$	-55	-	150	$^\circ\text{C}$	-
Operating junction temperature	$T_j$	-55	-	150	$^\circ\text{C}$	-
Mounting torque (Non FullPAK) TO-220, TO-247	-	-	-	60	Ncm	M3 and M3.5 screws
Mounting torque (FullPAK) TO-220FP	-	-	-	50	Ncm	M2.5 screws
Continuous diode forward current	$I_S$	-	-	32.9	A	$T_C=25^\circ\text{C}$
Diode pulse current <sup>2)</sup>	$I_{S,pulse}$	-	-	109	A	$T_C=25^\circ\text{C}$
Reverse diode dv/dt <sup>3)</sup>	dv/dt	-	-	15	V/ns	$V_{DS}=0\dots400\text{V}$ , $I_{SD}\leq I_S$ , $T_j=25^\circ\text{C}$ see table 8
Maximum diode commutation speed	di/dt	-	-	300	A/ $\mu\text{s}$	$V_{DS}=0\dots400\text{V}$ , $I_{SD}\leq I_S$ , $T_j=25^\circ\text{C}$ see table 8
Insulation withstand voltage for TO-220FP	$V_{ISO}$	-	-	2500	V	$V_{rms}$ , $T_C=25^\circ\text{C}$ , $t=1\text{min}$

<sup>1)</sup> Limited by  $T_{j,max}$ . Maximum duty cycle  $D=0.75$

<sup>2)</sup> Pulse width  $t_p$  limited by  $T_{j,max}$

<sup>3)</sup> Identical low side and high side switch with identical  $R_G$

### 3 Thermal characteristics

**Table 3 Thermal characteristics (Non FullPAK) TO-220, TO-247**

Parameter	Symbol	Values			Unit	Note / Test Condition
		Min.	Typ.	Max.		
Thermal resistance, junction - case	$R_{thJC}$	-	-	0.45	°C/W	-
Thermal resistance, junction - ambient	$R_{thJA}$	-	-	62	°C/W	leaded
Soldering temperature, wavesoldering only allowed at leads	$T_{sold}$	-	-	260	°C	1.6mm (0.063 in.) from case for 10s

**Table 4 Thermal characteristics (FullPAK) TO-220FP**

Parameter	Symbol	Values			Unit	Note / Test Condition
		Min.	Typ.	Max.		
Thermal resistance, junction - case	$R_{thJC}$	-	-	3.65	°C/W	-
Thermal resistance, junction - ambient	$R_{thJA}$	-	-	80	°C/W	leaded
Soldering temperature, wavesoldering only allowed at leads	$T_{sold}$	-	-	260	°C	1.6mm (0.063 in.) from case for 10s

## 4 Electrical characteristics

at  $T_j=25^\circ\text{C}$ , unless otherwise specified

**Table 5 Static characteristics**

Parameter	Symbol	Values			Unit	Note / Test Condition
		Min.	Typ.	Max.		
Drain-source breakdown voltage	$V_{(BR)DSS}$	600	-	-	V	$V_{GS}=0\text{V}$ , $I_D=1\text{mA}$
Gate threshold voltage	$V_{(GS)th}$	3.5	4.0	4.5	V	$V_{DS}=V_{GS}$ , $I_D=1.21\text{mA}$
Zero gate voltage drain current	$I_{DSS}$	-	-	5	$\mu\text{A}$	$V_{DS}=600$ , $V_{GS}=0\text{V}$ , $T_j=25^\circ\text{C}$ $V_{DS}=600$ , $V_{GS}=0\text{V}$ , $T_j=150^\circ\text{C}$
Gate-source leakage current	$I_{GSS}$	-	-	100	nA	$V_{GS}=20\text{V}$ , $V_{DS}=0\text{V}$
Drain-source on-state resistance	$R_{DS(on)}$	-	0.089	0.099	$\Omega$	$V_{GS}=10\text{V}$ , $I_D=14.5\text{A}$ , $T_j=25^\circ\text{C}$ $V_{GS}=10\text{V}$ , $I_D=14.5\text{A}$ , $T_j=150^\circ\text{C}$
Gate resistance	$R_G$	-	1	-	$\Omega$	$f=1\text{MHz}$ , open drain

**Table 6 Dynamic characteristics**

Parameter	Symbol	Values			Unit	Note / Test Condition
		Min.	Typ.	Max.		
Input capacitance	$C_{iss}$	-	3330	-	pF	$V_{GS}=0\text{V}$ , $V_{DS}=100\text{V}$ , $f=1\text{MHz}$
Output capacitance	$C_{oss}$	-	140	-	pF	$V_{GS}=0\text{V}$ , $V_{DS}=100\text{V}$ , $f=1\text{MHz}$
Effective output capacitance, energy related <sup>1)</sup>	$C_{o(er)}$	-	110	-	pF	$V_{GS}=0\text{V}$ , $V_{DS}=0\dots400\text{V}$
Effective output capacitance, time related <sup>2)</sup>	$C_{o(tr)}$	-	495	-	pF	$I_D=\text{constant}$ , $V_{GS}=0\text{V}$ , $V_{DS}=0\dots400\text{V}$
Turn-on delay time	$t_{d(on)}$	-	20	-	ns	$V_{DD}=400\text{V}$ , $V_{GS}=13\text{V}$ , $I_D=18.1\text{A}$ , $R_G=1.7\Omega$ ; see table 9
Rise time	$t_r$	-	10	-	ns	$V_{DD}=400\text{V}$ , $V_{GS}=13\text{V}$ , $I_D=18.1\text{A}$ , $R_G=1.7\Omega$ ; see table 9
Turn-off delay time	$t_{d(off)}$	-	50	-	ns	$V_{DD}=400\text{V}$ , $V_{GS}=13\text{V}$ , $I_D=18.1\text{A}$ , $R_G=1.7\Omega$ ; see table 9
Fall time	$t_f$	-	5	-	ns	$V_{DD}=400\text{V}$ , $V_{GS}=13\text{V}$ , $I_D=18.1\text{A}$ , $R_G=1.7\Omega$ ; see table 9

**Table 7 Gate charge characteristics**

Parameter	Symbol	Values			Unit	Note / Test Condition
		Min.	Typ.	Max.		
Gate to source charge	$Q_{gs}$	-	20	-	nC	$V_{DD}=400\text{V}$ , $I_D=18.1\text{A}$ , $V_{GS}=0$ to $10\text{V}$
Gate to drain charge	$Q_{gd}$	-	24	-	nC	$V_{DD}=400\text{V}$ , $I_D=18.1\text{A}$ , $V_{GS}=0$ to $10\text{V}$
Gate charge total	$Q_g$	-	70	-	nC	$V_{DD}=400\text{V}$ , $I_D=18.1\text{A}$ , $V_{GS}=0$ to $10\text{V}$
Gate plateau voltage	$V_{plateau}$	-	6.1	-	V	$V_{DD}=400\text{V}$ , $I_D=18.1\text{A}$ , $V_{GS}=0$ to $10\text{V}$

<sup>1)</sup>  $C_{o(er)}$  is a fixed capacitance that gives the same stored energy as  $C_{oss}$  while  $V_{DS}$  is rising from 0 to 400V

<sup>2)</sup>  $C_{o(tr)}$  is a fixed capacitance that gives the same charging time as  $C_{oss}$  while  $V_{DS}$  is rising from 0 to 400V

**Table 8 Reverse diode characteristics**

Parameter	Symbol	Values			Unit	Note / Test Condition
		Min.	Typ.	Max.		
Diode forward voltage	$V_{SD}$	-	0.9	-	V	$V_{GS}=0V, I_F=18.1A, T_j=25^\circ C$
Reverse recovery time	$t_{rr}$	-	470	-	ns	$V_R=400V, I_F=18.1A, di_F/dt=100A/\mu s$ ; see table 8
Reverse recovery charge	$Q_{rr}$	-	9	-	$\mu C$	$V_R=400V, I_F=18.1A, di_F/dt=100A/\mu s$ ; see table 8
Peak reverse recovery current	$I_{rrm}$	-	37	-	A	$V_R=400V, I_F=18.1A, di_F/dt=100A/\mu s$ ; see table 8

## 5 Electrical characteristics diagrams

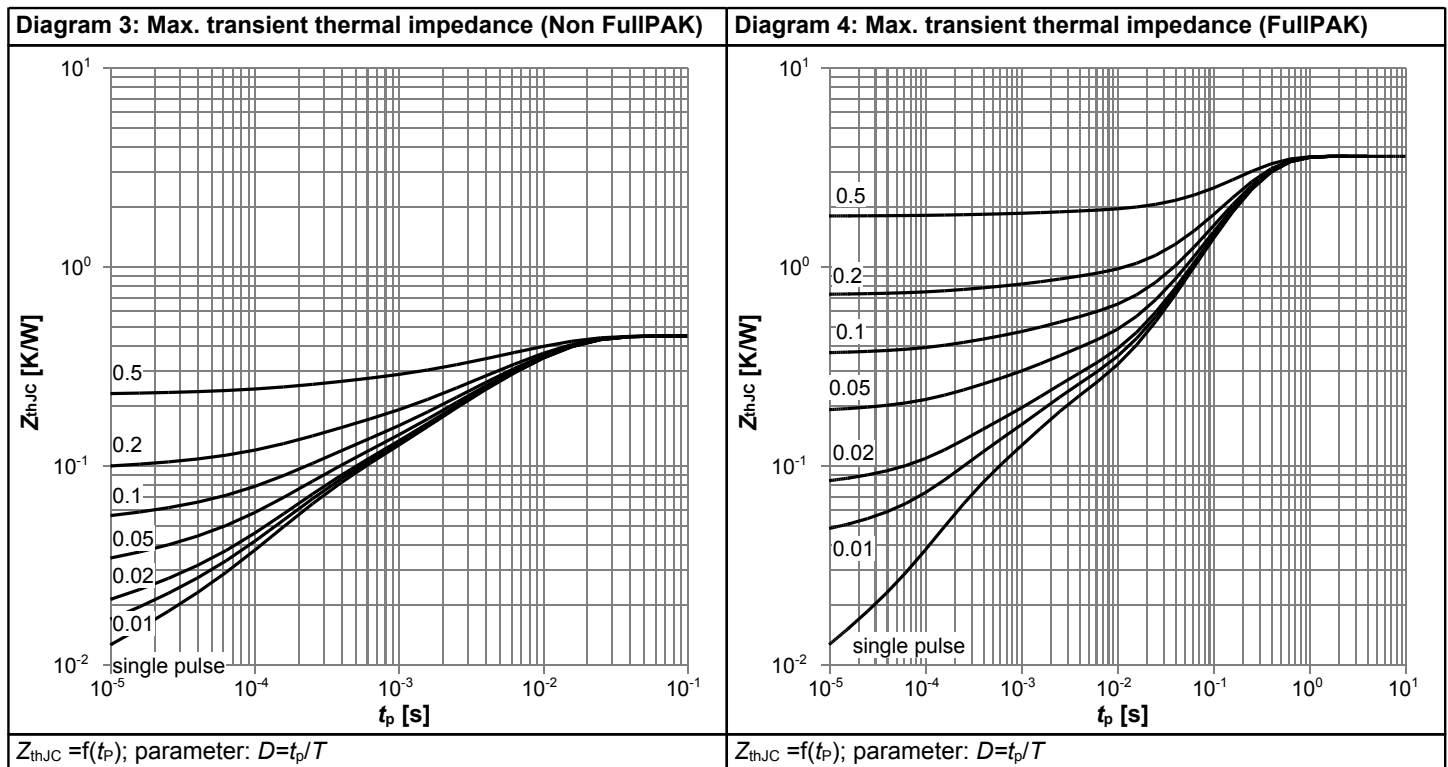
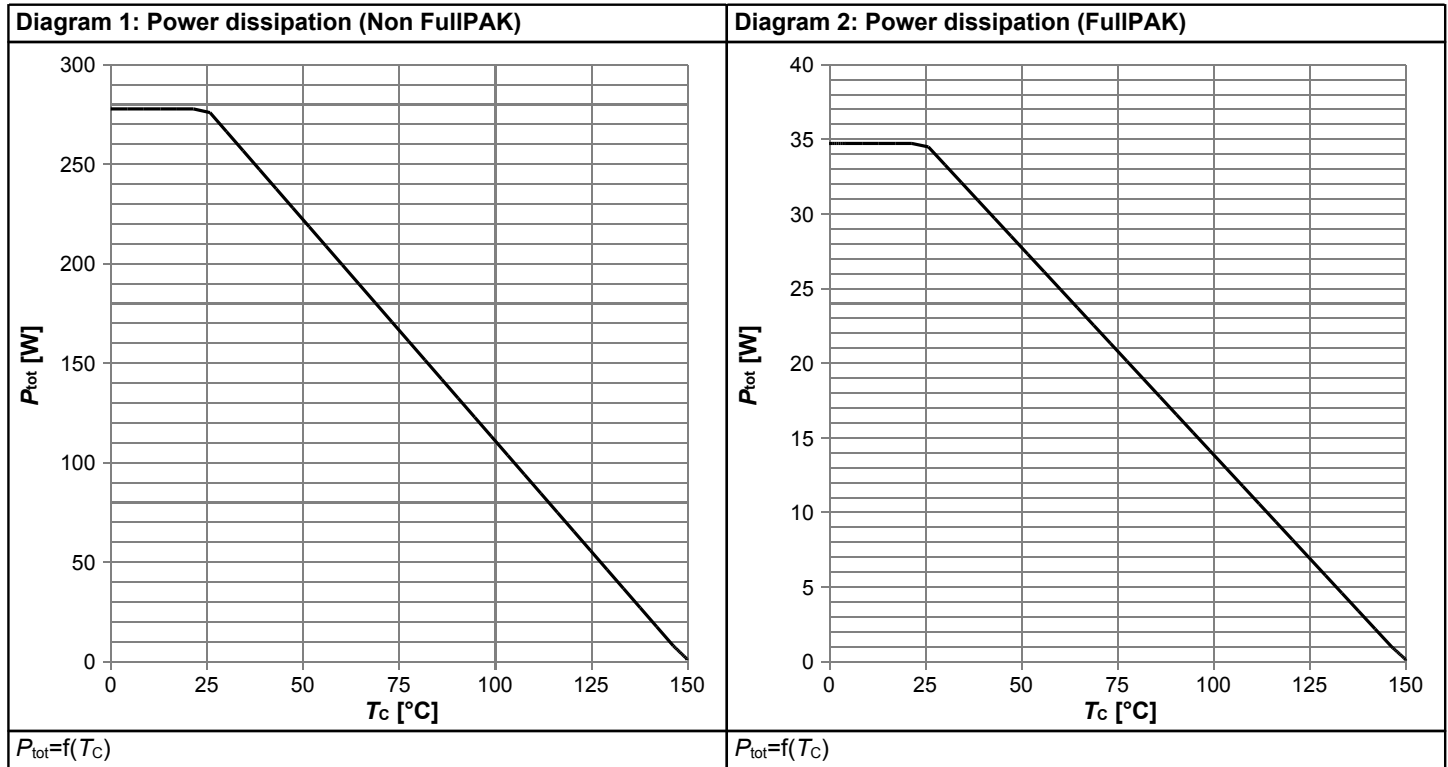
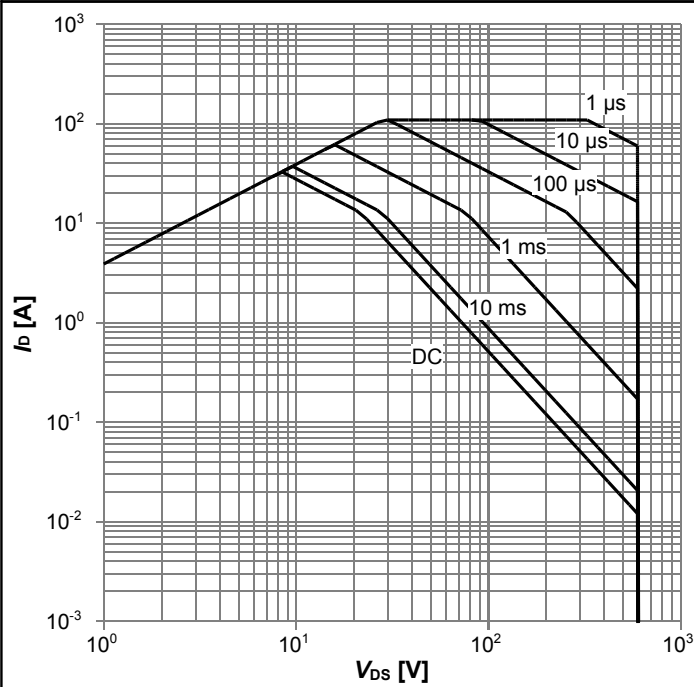

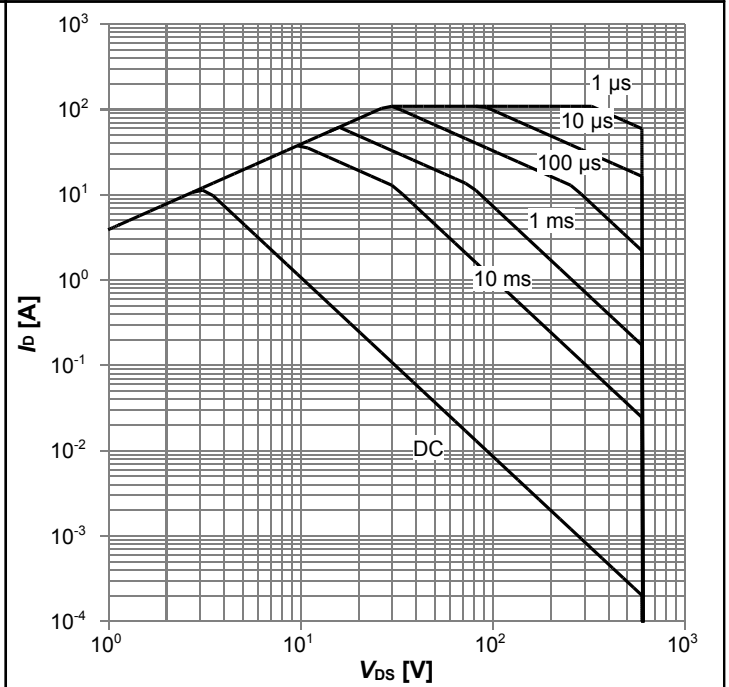

Diagram 5: Safe operating area (Non FullPAK)



$I_D=f(V_{DS}); T_C=25\text{ }^\circ\text{C}; D=0$ ; parameter:  $t_p$

Diagram 6: Safe operating area (FullPAK)



$I_D=f(V_{DS}); T_C=25\text{ }^\circ\text{C}; D=0$ ; parameter:  $t_p$

Diagram 7: Safe operating area (Non FullPAK)

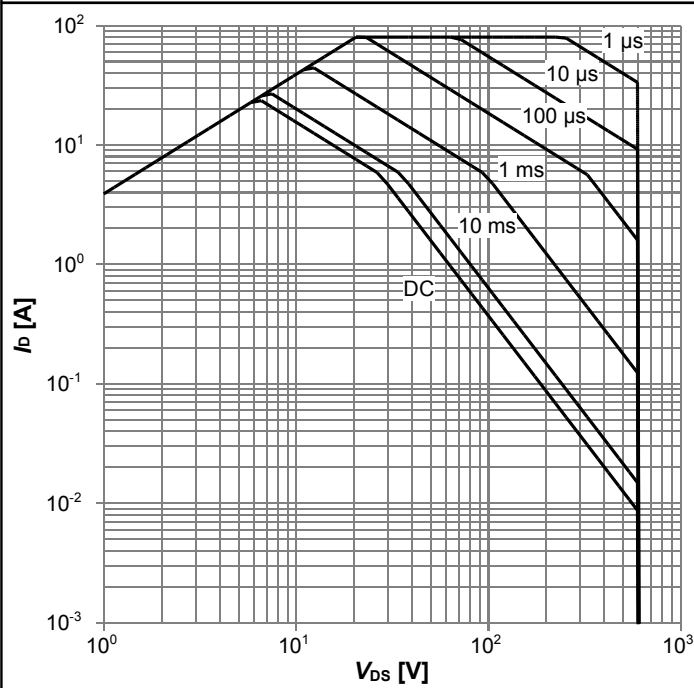

$I_D=f(V_{DS}); T_C=80\text{ }^\circ\text{C}; D=0$ ; parameter:  $t_p$

Diagram 8: Safe operating area (FullPAK)

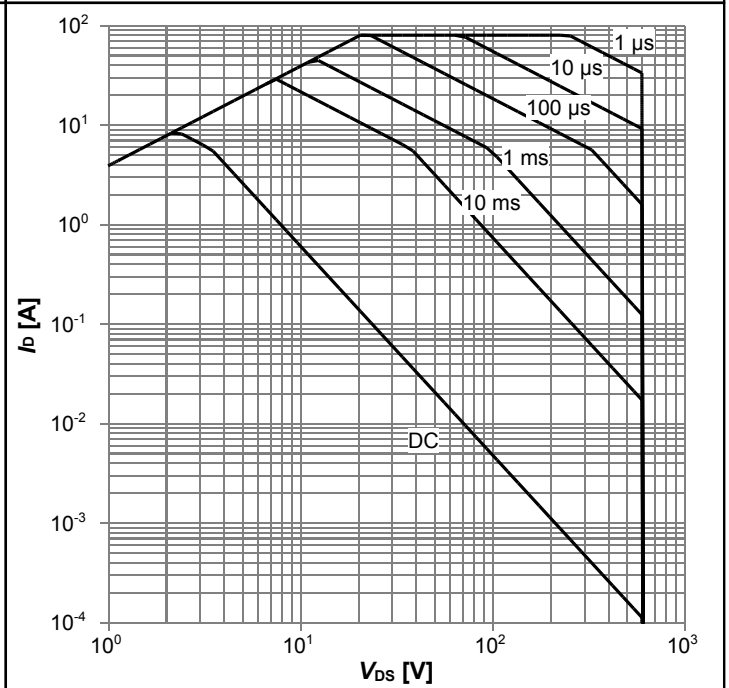

$I_D=f(V_{DS}); T_C=80\text{ }^\circ\text{C}; D=0$ ; parameter:  $t_p$

Diagram 9: Typ. output characteristics

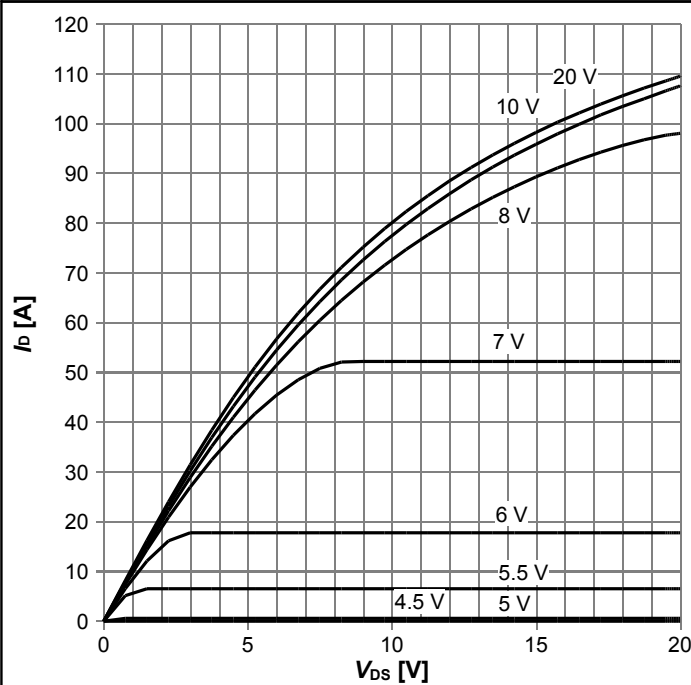

$I_D = f(V_{DS})$ ;  $T_j = 25^\circ\text{C}$ ; parameter:  $V_{GS}$

Diagram 10: Typ. output characteristics

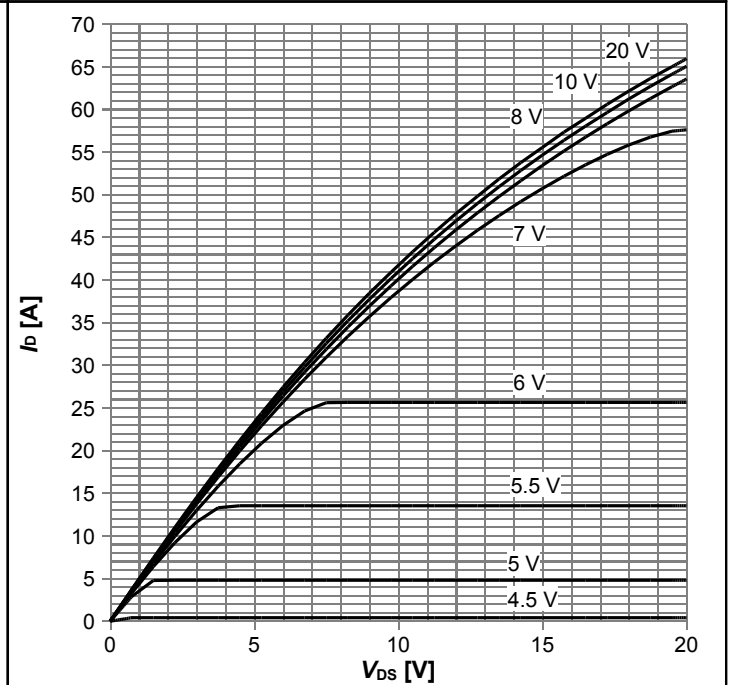

$I_D = f(V_{DS})$ ;  $T_j = 125^\circ\text{C}$ ; parameter:  $V_{GS}$

Diagram 11: Typ. drain-source on-state resistance

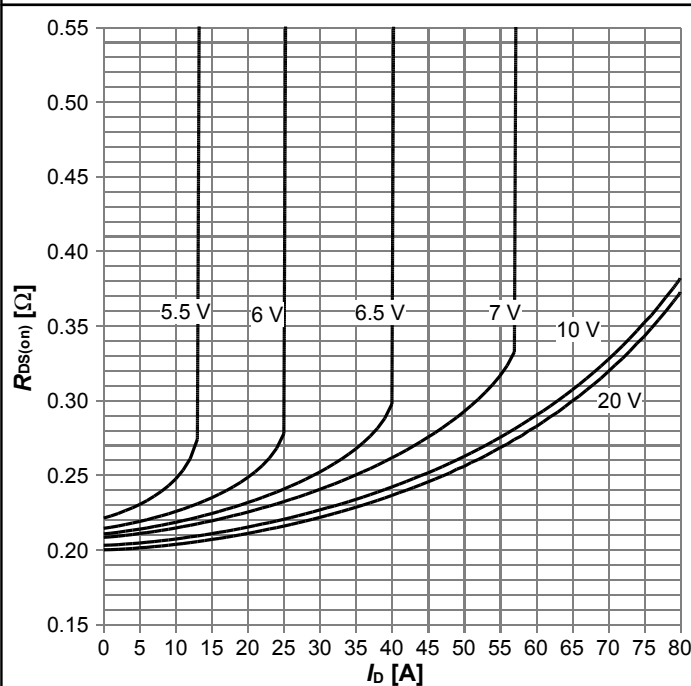

$R_{DS(on)} = f(I_D)$ ;  $T_j = 125^\circ\text{C}$ ; parameter:  $V_{GS}$

Diagram 12: Drain-source on-state resistance

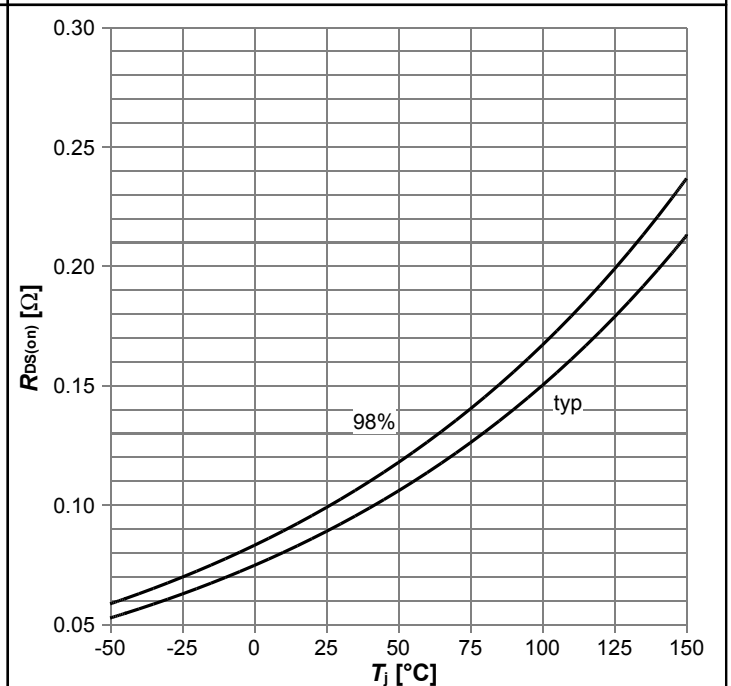

$R_{DS(on)} = f(T_j)$ ;  $I_D = 14.5\text{ A}$ ;  $V_{GS} = 10\text{ V}$

Diagram 13: Typ. transfer characteristics

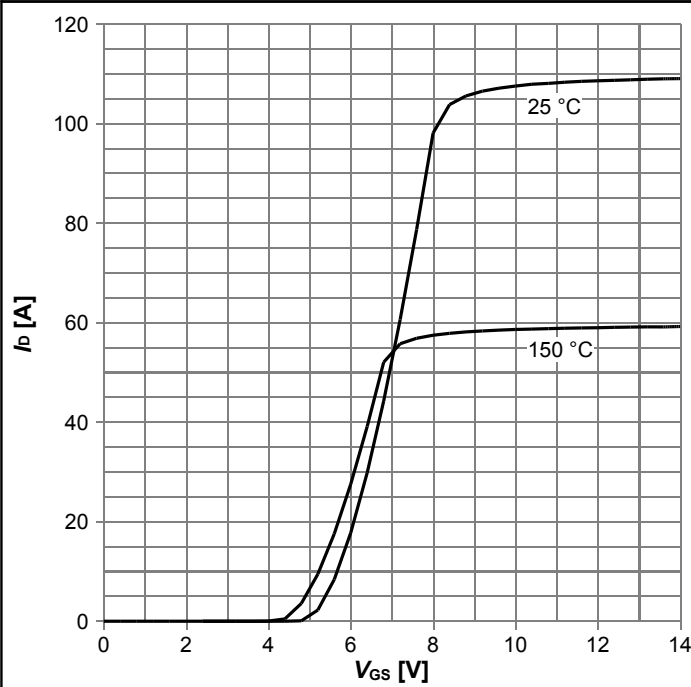

$I_D=f(V_{GS}); V_{DS}=20V; \text{parameter: } T_j$

Diagram 14: Typ. gate charge

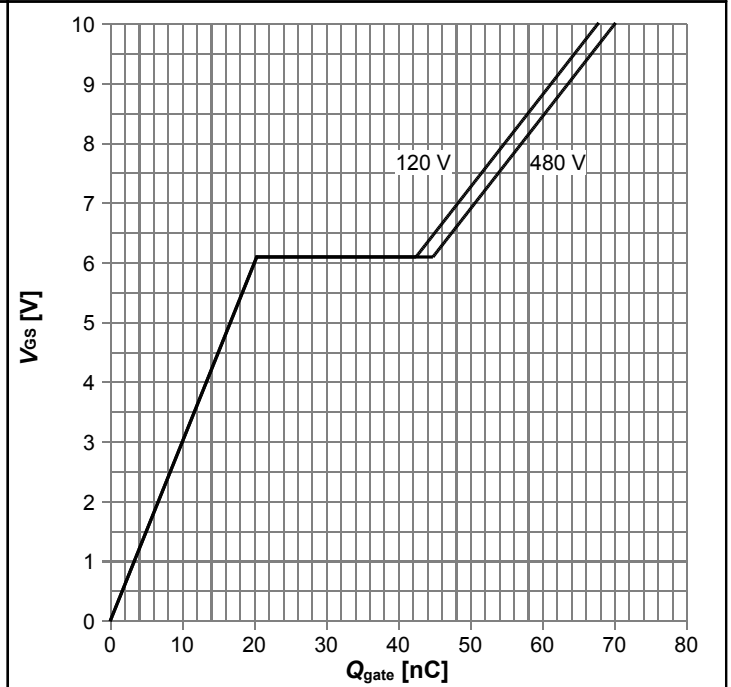

$V_{GS}=f(Q_{gate}); I_D=18.1 \text{ A pulsed}; \text{parameter: } V_{DD}$

Diagram 15: Forward characteristics of reverse diode

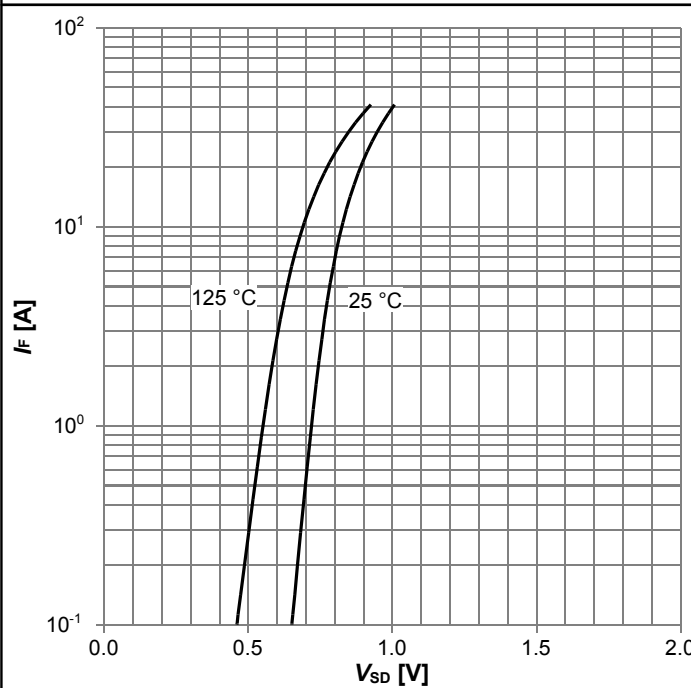

$I_F=f(V_{SD}); \text{parameter: } T_j$

Diagram 16: Avalanche energy

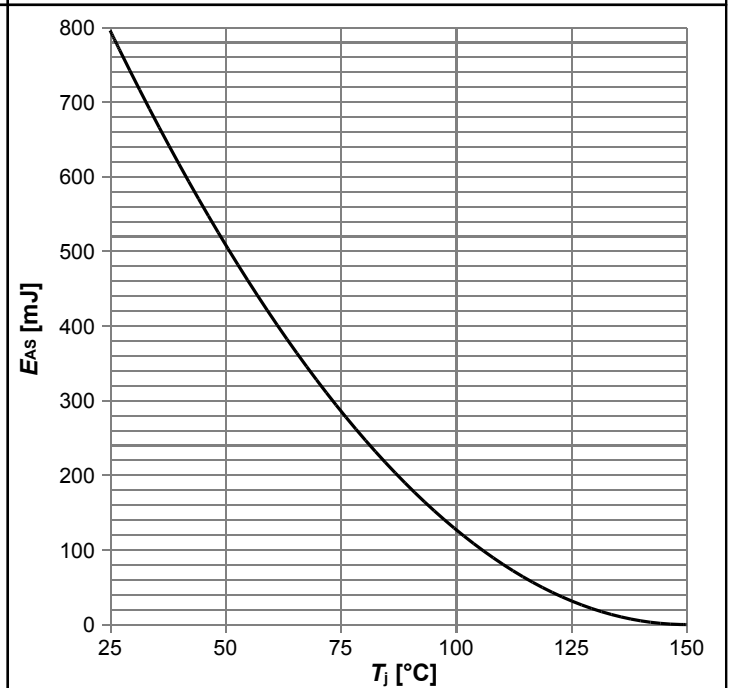

$E_{AS}=f(T_j); I_D=6.6 \text{ A}; V_{DD}=50 \text{ V}$

Diagram 17: Drain-source breakdown voltage

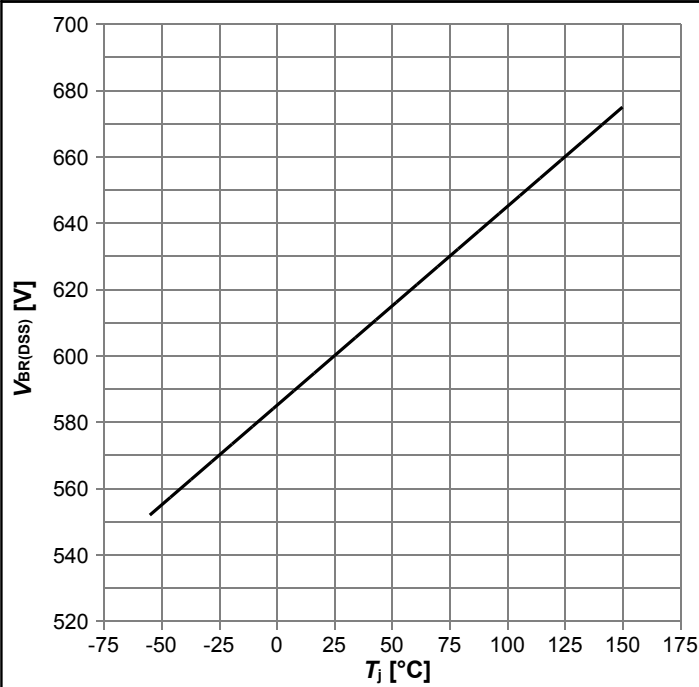

$V_{BR(DSS)}=f(T_j); I_D=1 \text{ mA}$

Diagram 18: Typ. capacitances

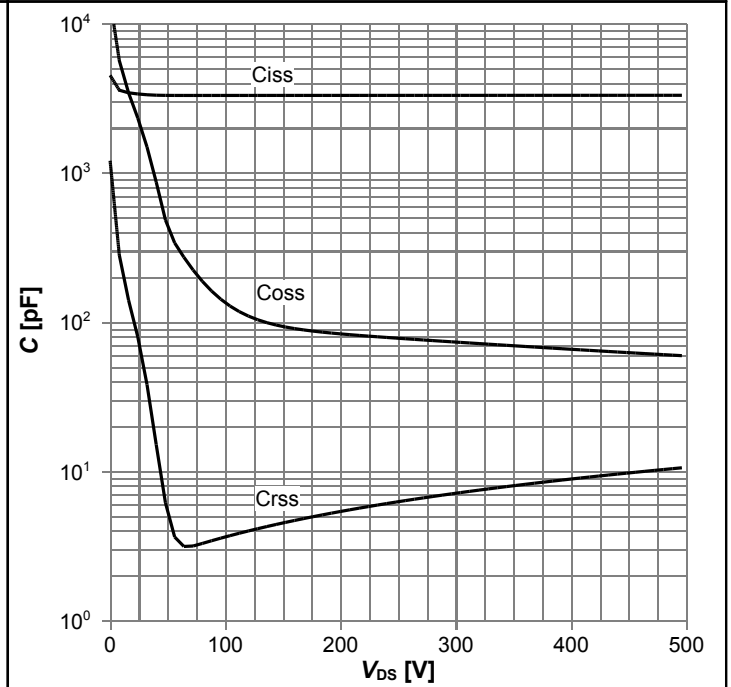

$C=f(V_{DS}); V_{GS}=0 \text{ V}; f=1 \text{ MHz}$

Diagram 19: Typ. Coss stored energy

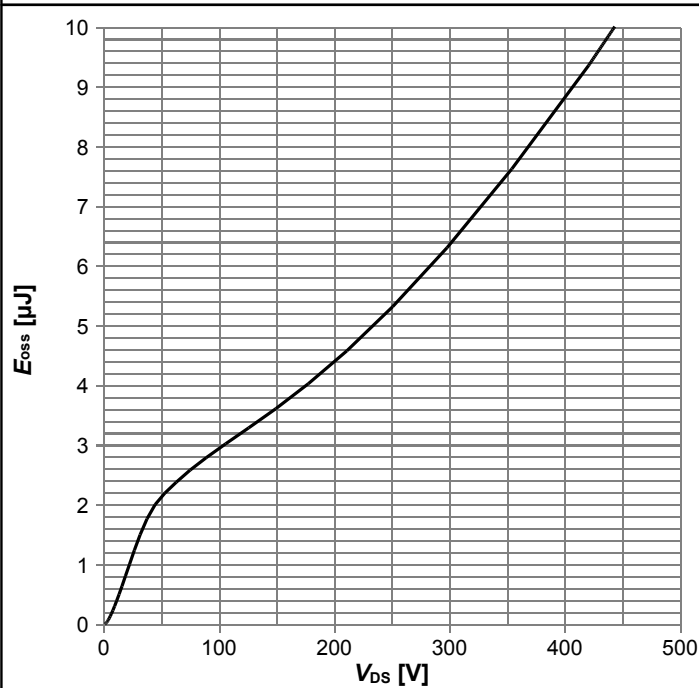

$E_{oss}=f(V_{DS})$

## 6 Test Circuits

**Table 9 Diode characteristics**

Test circuit for diode characteristics	Diode recovery waveform
<p><math>R_{g1} = R_{g2}</math></p>	<p><math>t_{tr} = t_F + t_S</math>  <math>Q_r = Q_F + Q_S</math></p>

**Table 10 Switching times**

Switching times test circuit for inductive load	Switching times waveform

**Table 11 Unclamped inductive load**

Unclamped inductive load test circuit	Unclamped inductive waveform

## 7 Package Outlines

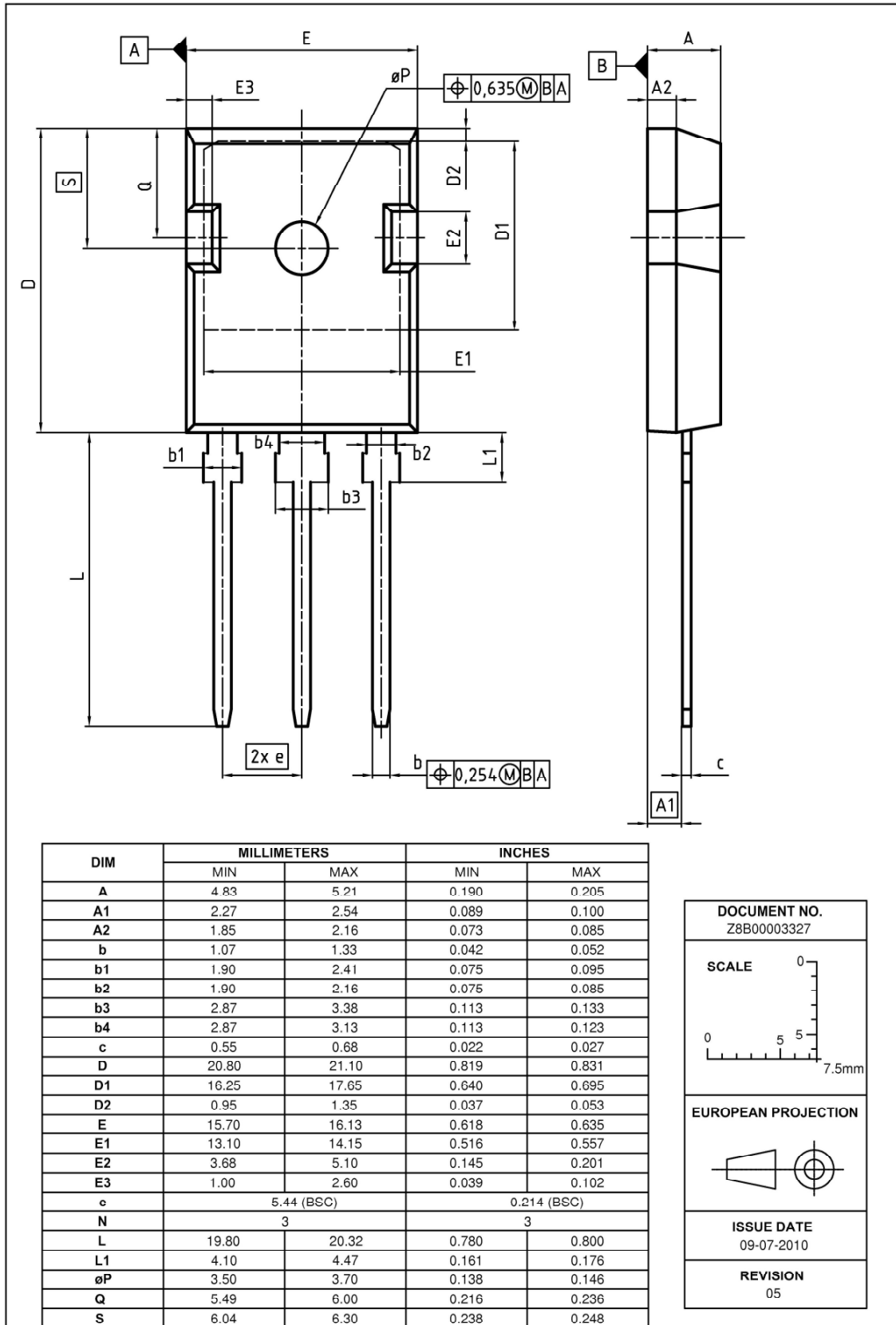

Figure 1 Outline PG-TO 247, dimensions in mm/inches

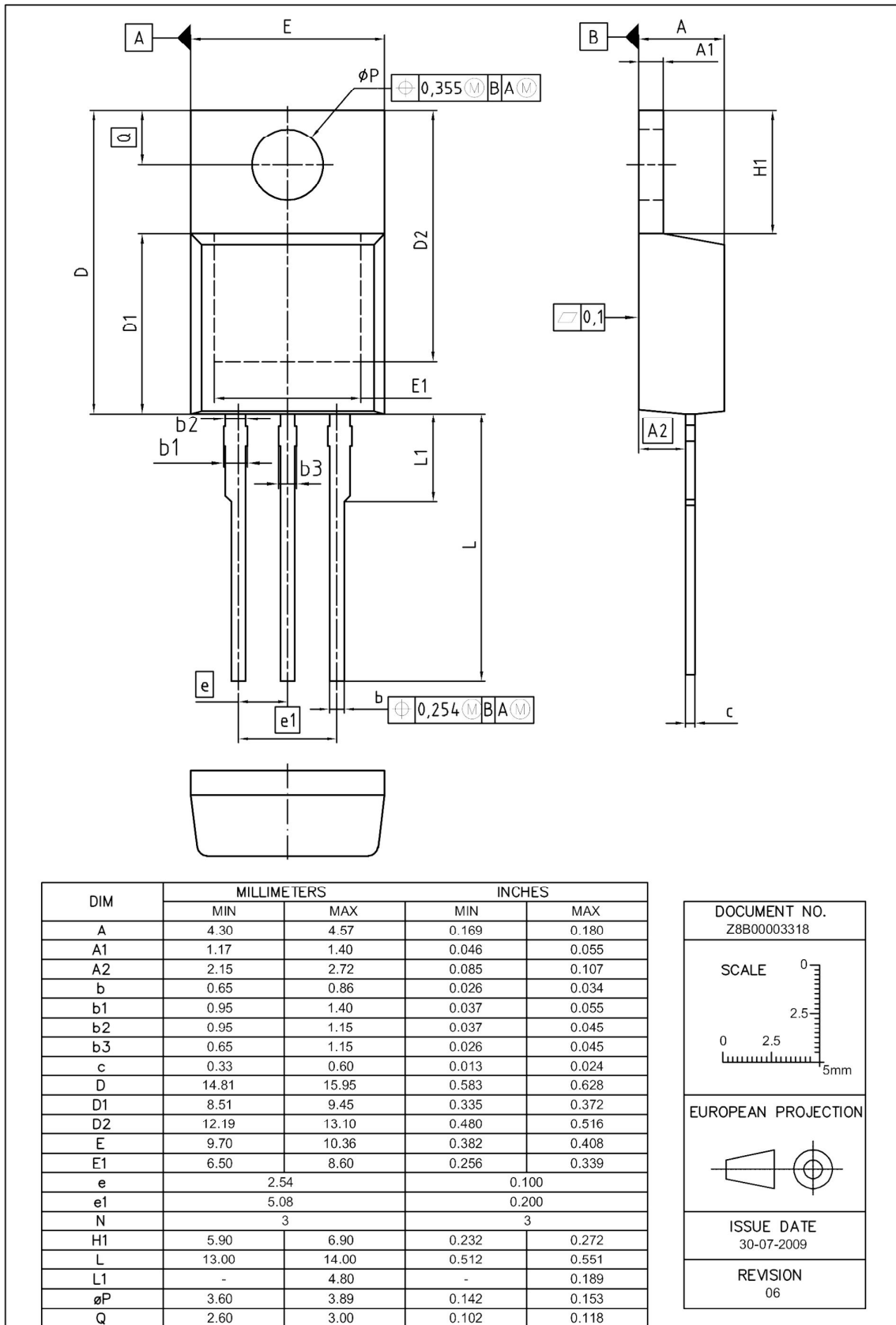
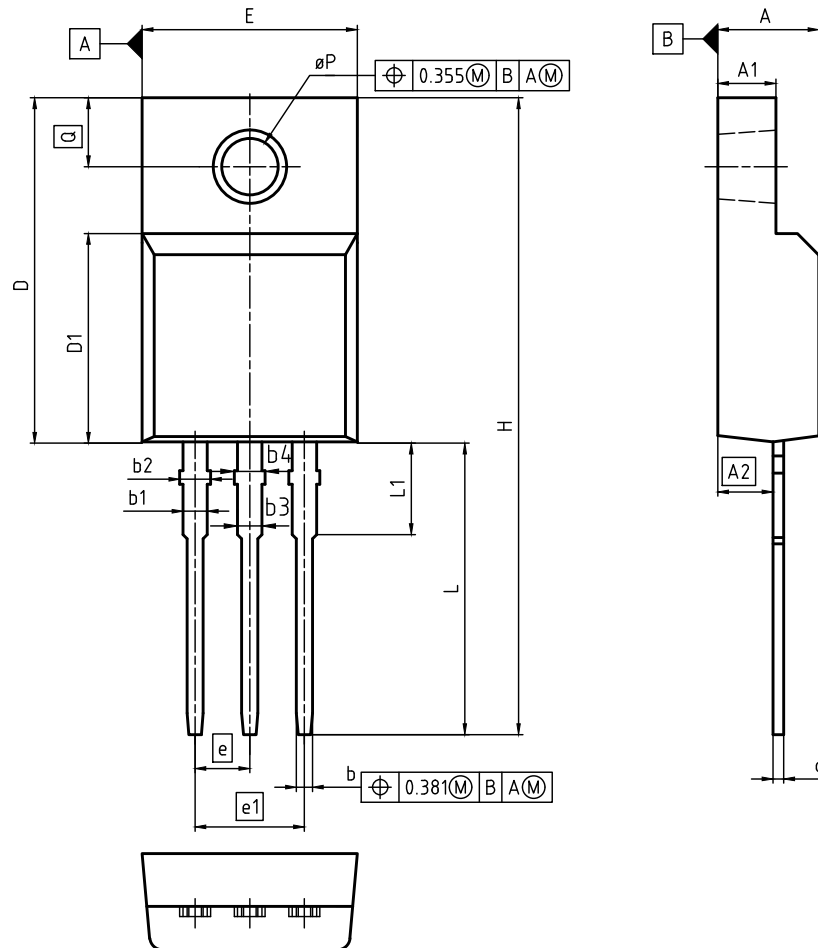

Figure 2 Outline PG-TO 220, dimensions in mm/inches



DIM	MILLIMETERS		INCHES	
	MIN	MAX	MIN	MAX
A	4.50	4.90	0.177	0.193
A1	2.34	2.85	0.092	0.112
A2	2.42	2.86	0.095	0.113
b	0.65	0.90	0.026	0.035
b1	0.95	1.38	0.037	0.054
b2	0.95	1.51	0.037	0.059
b3	0.65	1.38	0.026	0.054
b4	0.65	1.51	0.026	0.059
c	0.40	0.63	0.016	0.025
D	15.67	16.15	0.617	0.636
D1	8.97	9.83	0.353	0.387
E	10.00	10.65	0.394	0.419
e	2.54 (BSC)		0.100 (BSC)	
e1	5.08		0.200	
N	3		3	
H	28.70	29.75	1.130	1.171
L	12.78	13.75	0.503	0.541
L1	2.83	3.45	0.111	0.136
øP	2.95	3.38	0.116	0.133
Q	3.15	3.50	0.124	0.138

DOCUMENT NO.  
Z8B00003319

SCALE

EUROPEAN PROJECTION

ISSUE DATE  
05-05-2014

REVISION  
04

Figure 3 Outline PG-TO 220 FullPAK, dimensions in mm/inches



## 8 Appendix A

### Table 12 Related Links

- IFX CoolMOS™ P6 Webpage: [www.infineon.com](http://www.infineon.com)
- IFX CoolMOS™ P6 application note: [www.infineon.com](http://www.infineon.com)
- IFX CoolMOS™ P6 simulation model: [www.infineon.com](http://www.infineon.com)
- IFX Design tools: [www.infineon.com](http://www.infineon.com)

## Revision History

IPW60R099P6, IPP60R099P6, IPA60R099P6

**Revision: 2015-05-18, Rev. 2.1**

Previous Revision

Revision	Date	Subjects (major changes since last revision)
2.0	2014-03-07	Release of final version
2.1	2015-05-18	Rdson max change from 105 to 99mOhm

### We Listen to Your Comments

Any information within this document that you feel is wrong, unclear or missing at all? Your feedback will help us to continuously improve the quality of this document. Please send your proposal (including a reference to this document) to:

[erratum@infineon.com](mailto:erratum@infineon.com)

### Published by

**Infineon Technologies AG**

**81726 München, Germany**

**© 2015 Infineon Technologies AG**

**All Rights Reserved.**

### Legal Disclaimer

The information given in this document shall in no event be regarded as a guarantee of conditions or characteristics. With respect to any examples or hints given herein, any typical values stated herein and/or any information regarding the application of the device, Infineon Technologies hereby disclaims any and all warranties and liabilities of any kind, including without limitation, warranties of non-infringement of intellectual property rights of any third party.

### Information

For further information on technology, delivery terms and conditions and prices please contact your nearest Infineon Technologies Office ([www.infineon.com](http://www.infineon.com)).

### Warnings

Due to technical requirements, components may contain dangerous substances. For information on the types in question, please contact the nearest Infineon Technologies Office.

The Infineon Technologies component described in this Data Sheet may be used in life-support devices or systems and/or automotive, aviation and aerospace applications or systems only with the express written approval of Infineon Technologies, if a failure of such components can reasonably be expected to cause the failure of that life-support, automotive, aviation and aerospace device or system or to affect the safety or effectiveness of that device or system. Life support devices or systems are intended to be implanted in the human body or to support and/or maintain and sustain and/or protect human life. If they fail, it is reasonable to assume that the health of the user or other persons may be endangered.

单击下面可查看定价，库存，交付和生命周期等信息

[>>Infineon Technologies\(英飞凌\)](#)

[>>点击查看相关商品](#)