

OptiMOS™ -5 Power-Transistor

Product Summary

V_{DS}	100	V
$R_{DS(on),max}$	13	mΩ
I_D	40	A

Features

- OptiMOS™ - power MOSFET for automotive applications
- N-channel - Enhancement mode - Normal Level
- AEC Q101 qualified
- MSL1 up to 260°C peak reflow
- 175°C operating temperature
- Green Product (RoHS compliant)
- 100% Avalanche tested
- Feasible for automatic optical inspection (AOI)

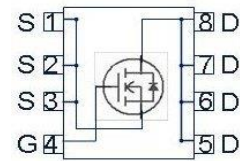
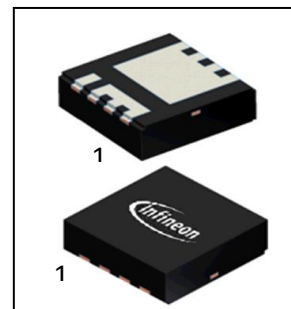
PG-TSDSON-8-33

Type	Package	Marking
IAUZ40N10S5N130	PG-TSDSON-8-33	5N1N130

Maximum ratings, at $T_j=25\text{ °C}$, unless otherwise specified

Parameter	Symbol	Conditions	Value	Unit
Continuous drain current ¹⁾²⁾	I_D	$T_C=25\text{ °C}, V_{GS}=10\text{V}$	40	A
		$T_C=100\text{ °C}, V_{GS}=10\text{V}$	35	
Pulsed drain current ²⁾	$I_{D,pulse}$	$T_C=25\text{ °C}$	160	
Avalanche energy, single pulse ²⁾	E_{AS}	$I_D=20\text{A}$	60	mJ
Avalanche current, single pulse	I_{AS}	-	22	A
Gate source voltage	V_{GS}	-	±20	V
Power dissipation	P_{tot}	$T_C=25\text{ °C}$ $T_J=175\text{ °C}$	68	W
Operating and storage temperature	T_j, T_{stg}	-	-55 ... +175	°C

Parameter	Symbol	Conditions	Values			Unit
			min.	typ.	max.	
Thermal characteristics²⁾						
Thermal resistance, junction - case	R_{thJC}	-	-	-	2.2	K/W
Thermal resistance, junction - ambient	R_{thJA}	6 cm ² cooling area ³⁾	-	-	62	

Electrical characteristics, at $T_j=25^\circ\text{C}$, unless otherwise specified

Static characteristics

Drain-source breakdown voltage	$V_{(BR)DSS}$	$V_{GS}=0V, I_D=1\text{mA}$	100	-	-	V
Gate threshold voltage	$V_{GS(th)}$	$V_{DS}=V_{GS}, I_D=27\mu\text{A}$	2.2	3.0	3.8	
Zero gate voltage drain current	I_{DSS}	$V_{DS}=100V, V_{GS}=0V, T_j=25^\circ\text{C}$	-	-	1	μA
		$V_{DS}=100V, V_{GS}=0V, T_j=125^\circ\text{C}^{2)}$	-	-	100	
Gate-source leakage current	I_{GSS}	$V_{GS}=20V, V_{DS}=0V$	-	-	100	nA
Drain-source on-state resistance	$R_{DS(on)}$	$V_{GS}=6V, I_D=10\text{A}$	-	14	17	m Ω
		$V_{GS}=10V, I_D=20\text{A}$	-	10.8	13	
Gate resistance ²⁾	R_G		-	1.2	-	Ω

Parameter	Symbol	Conditions	Values			Unit
			min.	typ.	max.	

Dynamic characteristics²⁾

Input capacitance	C_{iss}	$V_{GS}=0V, V_{DS}=50V,$ $f=1MHz$	-	1173	1525	pF
Output capacitance	C_{oss}		-	197	256	
Reverse transfer capacitance	C_{rss}		-	11	17	
Turn-on delay time	$t_{d(on)}$	$V_{DD}=50V, V_{GS}=10V,$ $I_D=40A, R_G=3.5\Omega$	-	4	-	ns
Rise time	t_r		-	1	-	
Turn-off delay time	$t_{d(off)}$		-	6	-	
Fall time	t_f		-	5	-	

Gate Charge Characteristics²⁾

Gate to source charge	Q_{gs}	$V_{DD}=50V, I_D=20A,$ $V_{GS}=0$ to 10V	-	5.5	7.2	nC
Gate to drain charge	Q_{gd}		-	3.7	6.0	
Gate charge total	Q_g		-	17	24	
Gate plateau voltage	$V_{plateau}$		-	4.7	-	V

Reverse Diode

Diode continuous forward current ²⁾	I_S	$T_C=25^\circ C$	-	-	40	A
Diode pulse current ²⁾	$I_{S,pulse}$		-	-	160	
Diode forward voltage	V_{SD}	$V_{GS}=0V, I_F=20A,$ $T_j=25^\circ C$	-	0.9	1.1	V
Reverse recovery time ²⁾	t_{rr}	$V_R=40V, I_F=40A,$ $di_F/dt=100A/\mu s$	-	40	-	ns
Reverse recovery charge ²⁾	Q_{rr}		-	39	-	nC

¹⁾ Current is limited by package; with an $R_{thJC} = 2.2K/W$ the chip is able to carry 50A at 25°C.

²⁾ The parameter is not subject to production test- verified by design/characterization.

³⁾ Device on 40 mm x 40 mm x 1.5 mm epoxy PCB FR4 with 6 cm² (one layer, 70 μm thick) copper area for drain connection. PCB is vertical in still air.

1 Power dissipation

$$P_{\text{tot}} = f(T_C); V_{\text{GS}} = 10 \text{ V}$$

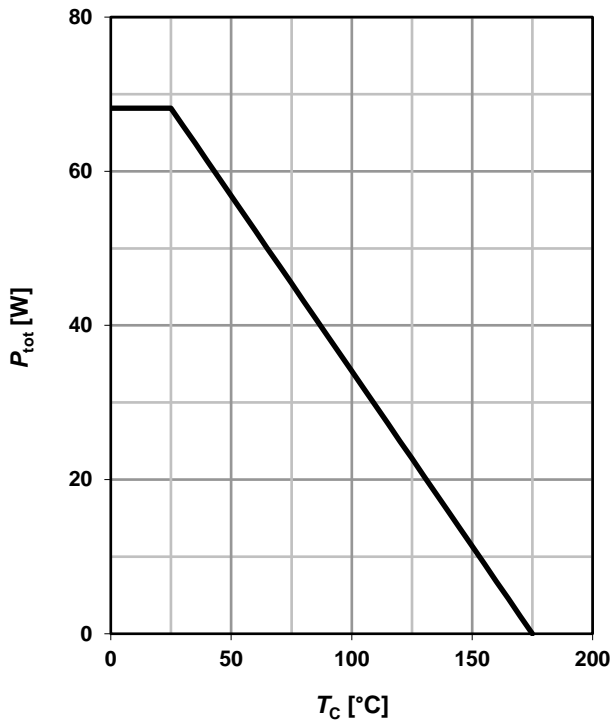
2 Drain current

$$I_D = f(T_C); V_{\text{GS}} = 10 \text{ V}$$

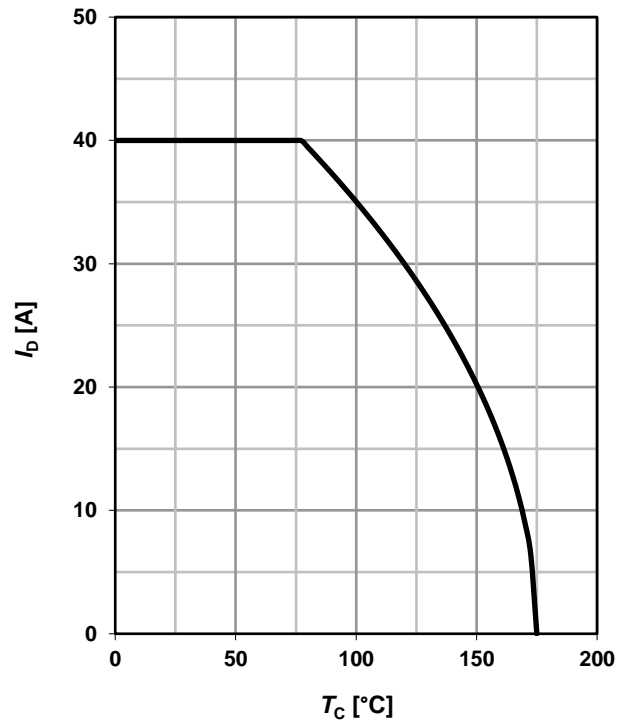
3 Safe operating area

$$I_D = f(V_{\text{DS}}); T_C = 25 \text{ °C}; D = 0$$

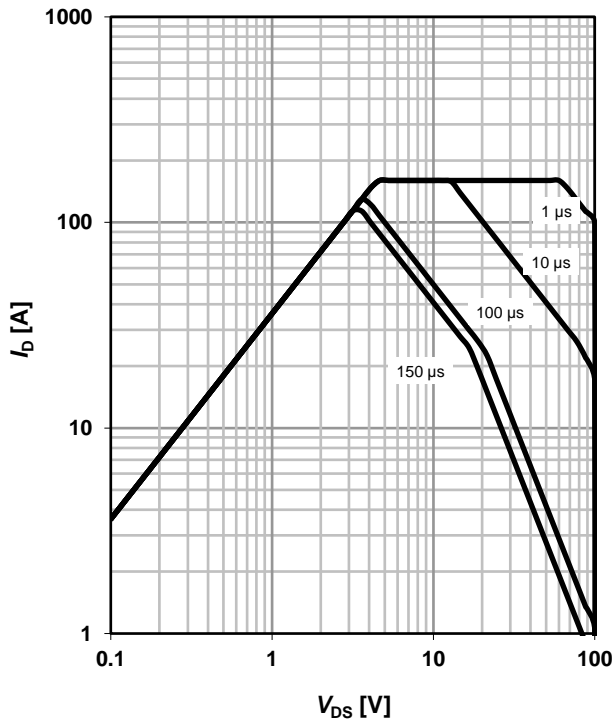
 parameter: t_p

4 Max. transient thermal impedance

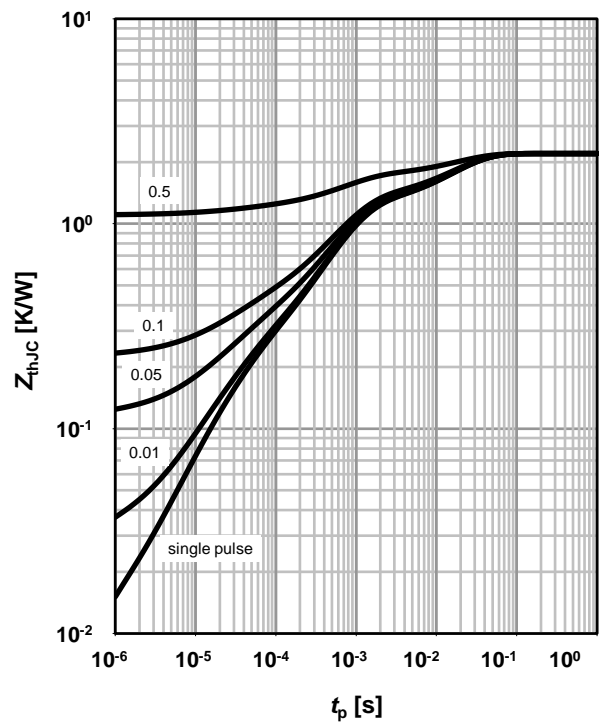
$$Z_{\text{thJC}} = f(t_p)$$

 parameter: $D = t_p/T$

5 Typ. output characteristics

$I_D = f(V_{DS}); T_j = 25\text{ }^\circ\text{C}$

parameter: V_{GS}

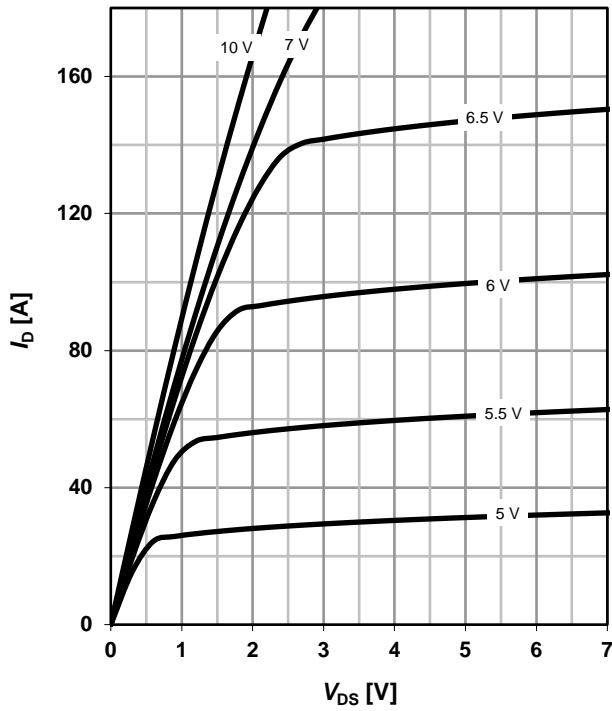

6 Typ. drain-source on-state resistance

$R_{DS(on)} = f(I_D); T_j = 25\text{ }^\circ\text{C}$

parameter: V_{GS}

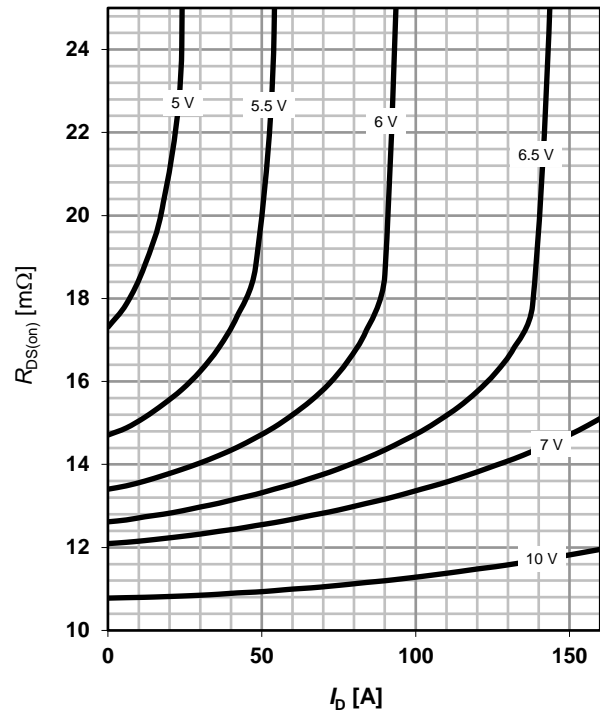

7 Typ. transfer characteristics

$I_D = f(V_{GS}); V_{DS} = 6\text{ V}$

parameter: T_j

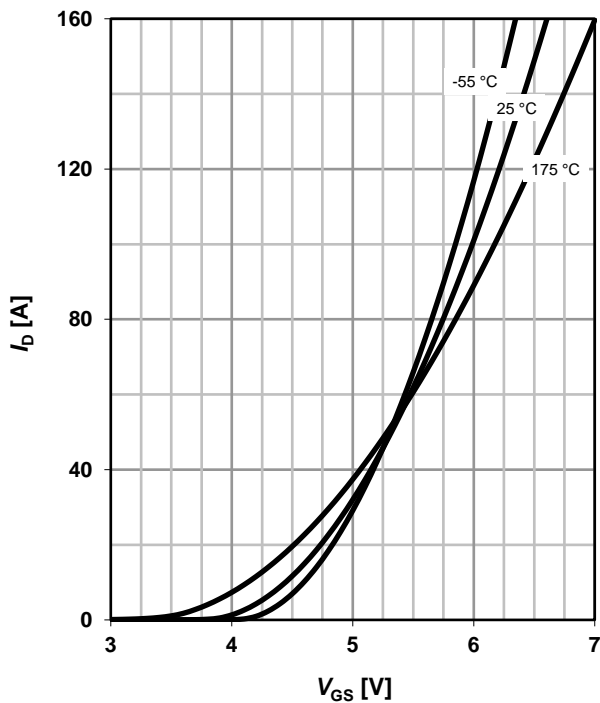

8 Typ. drain-source on-state resistance

$R_{DS(on)} = f(T_j); I_D = 20\text{ A}; V_{GS} = 10\text{ V}$

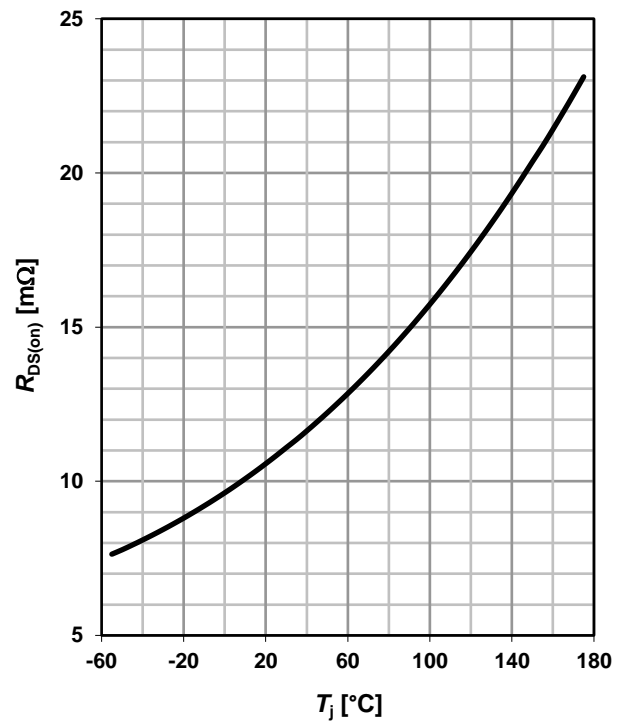

9 Typ. gate threshold voltage

$V_{GS(th)} = f(T_j); V_{GS} = V_{DS}$

parameter: I_D

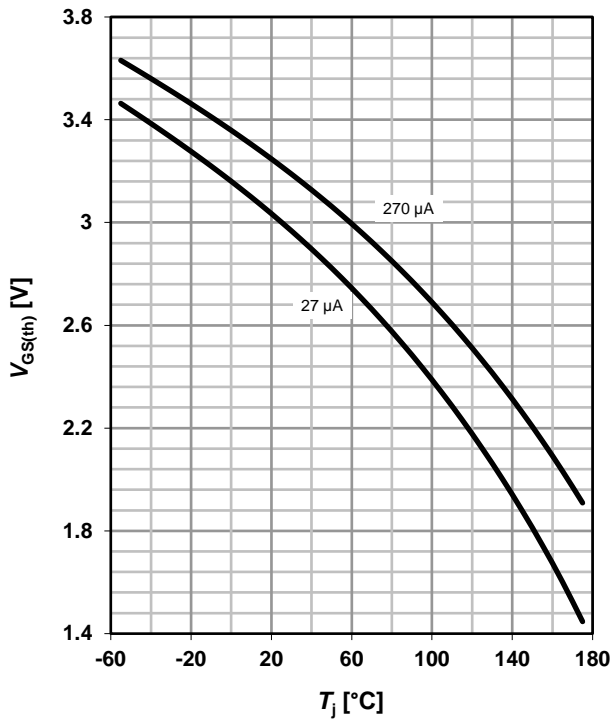

10 Typ. capacitances

$C = f(V_{DS}); V_{GS} = 0 \text{ V}; f = 1 \text{ MHz}$

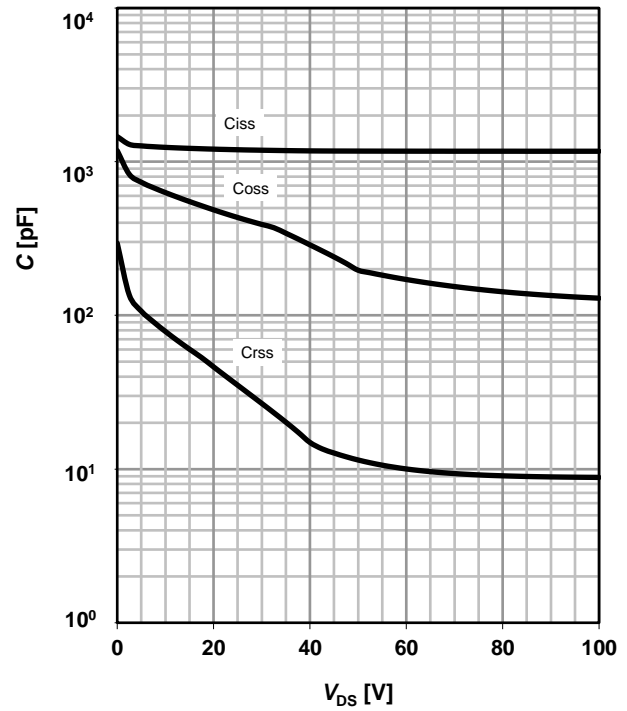

11 Typical forward diode characteristics

$I_F = f(V_{SD})$

parameter: T_j

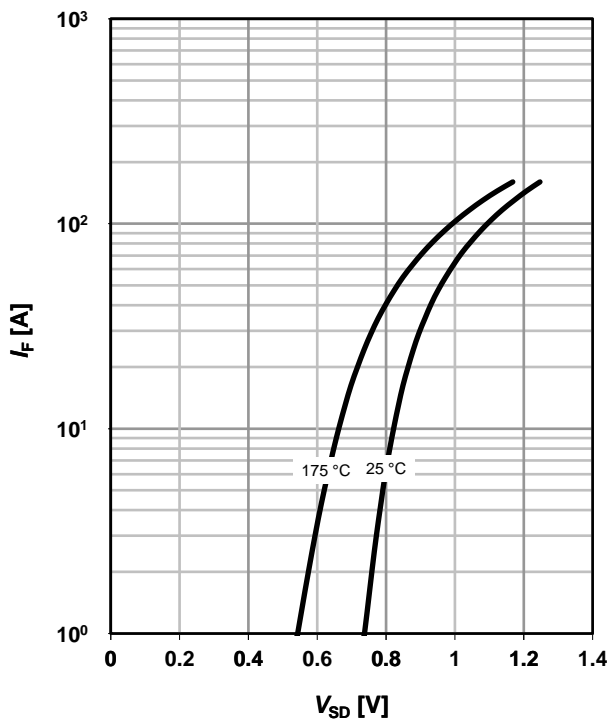

12 Avalanche characteristics

$I_{AS} = f(t_{AV})$

parameter: $T_{j(start)}$

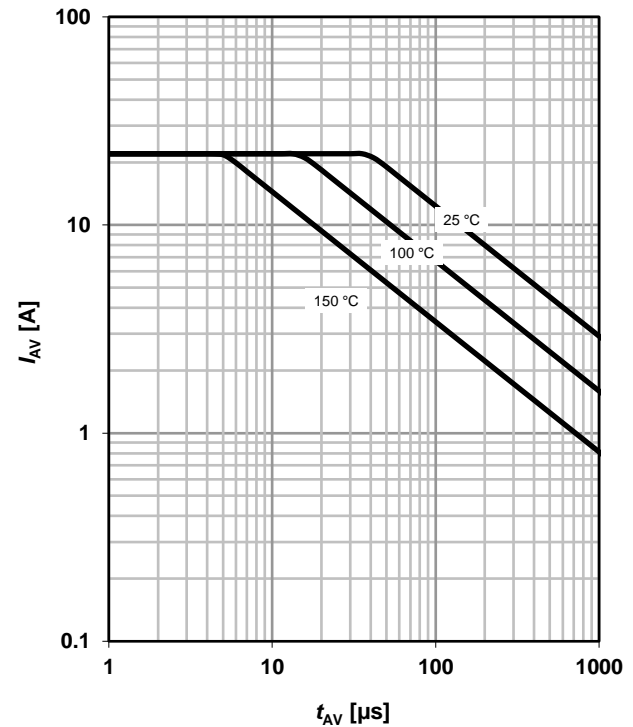

13 Avalanche energy

$$E_{AS} = f(T_j)$$

parameter: I_D

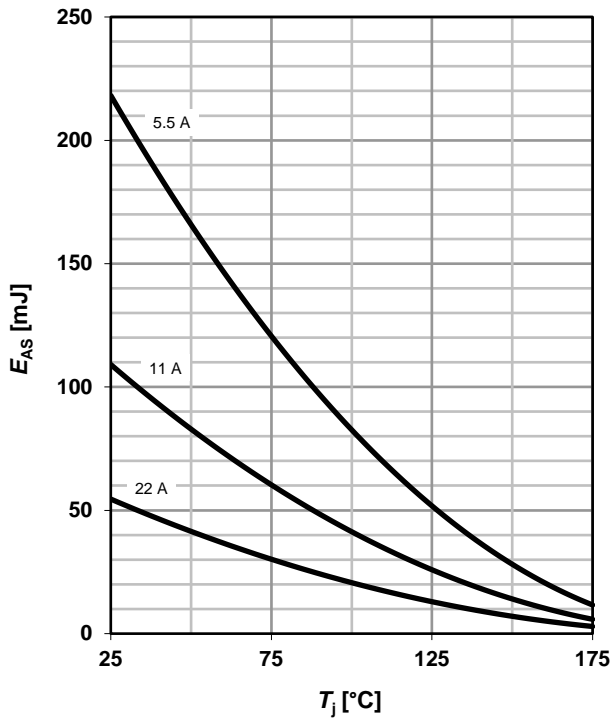

14 Drain-source breakdown voltage

$$V_{BR(DSS)} = f(T_j); I_D = 1 \text{ mA}$$

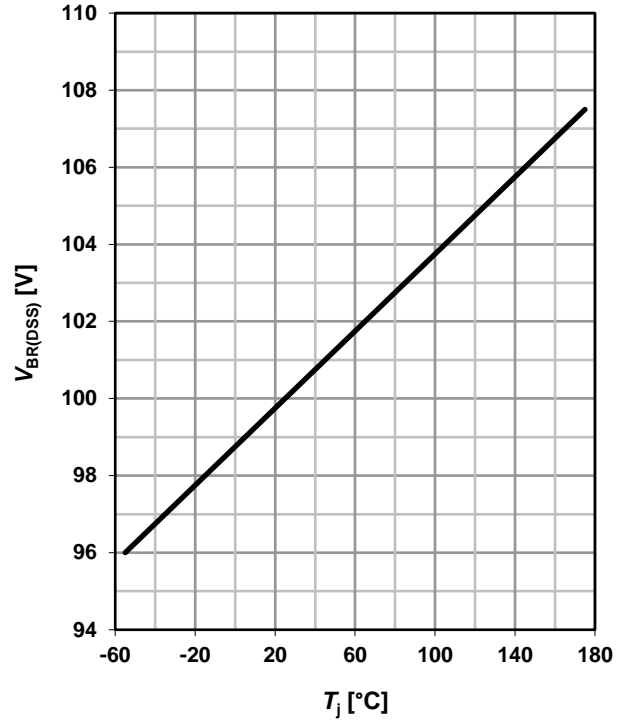

15 Typ. gate charge

$$V_{GS} = f(Q_{gate}); I_D = 20 \text{ A pulsed}$$

parameter: V_{DD}

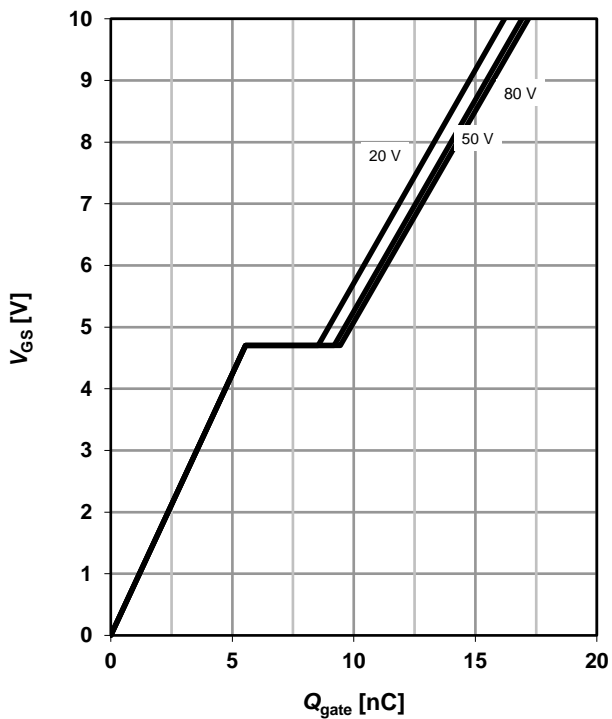

16 Gate charge waveforms

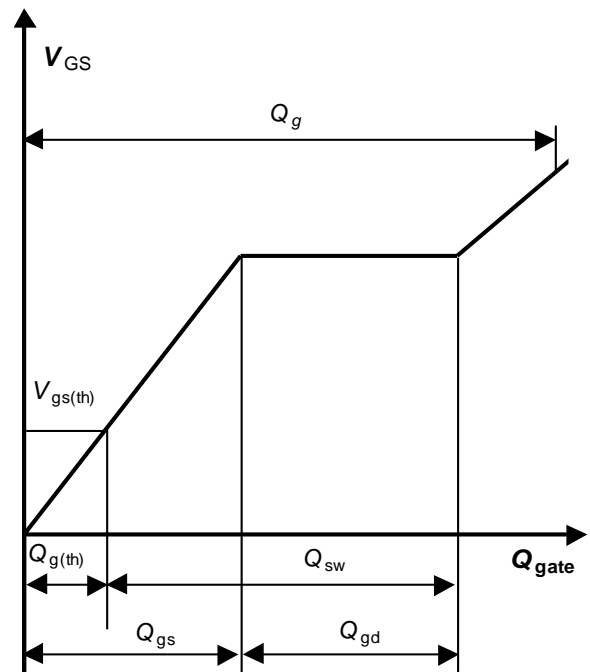

PG-TSDSON-8: Outline

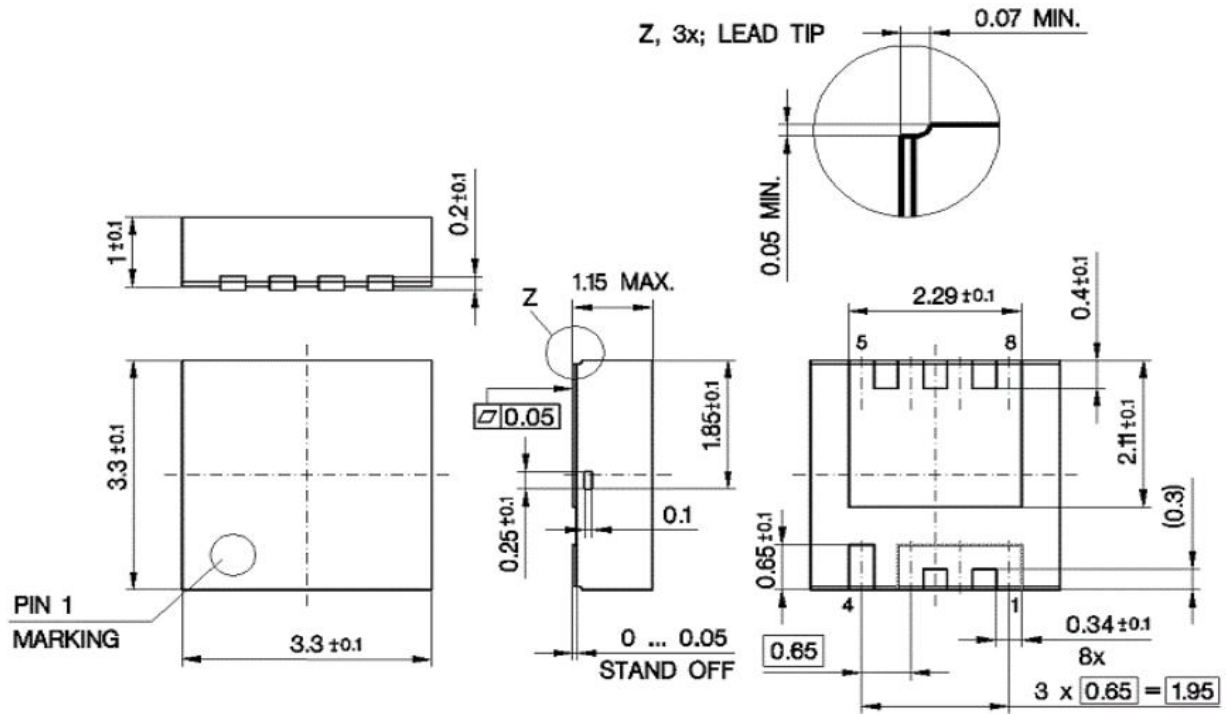

Footprint

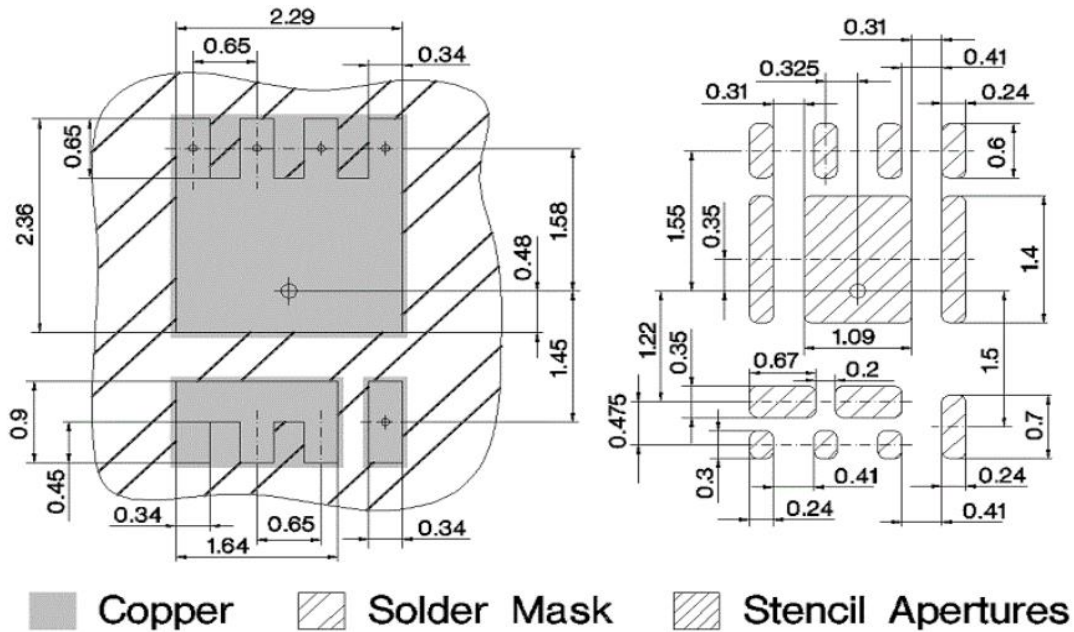

Dimensions in mm

Packaging

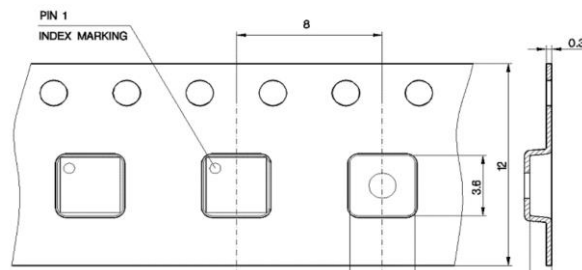

Published by
Infineon Technologies AG
85579 Neubiberg, Germany

© Infineon Technologies AG 2019
All Rights Reserved.

Legal Disclaimer

The information given in this document shall in no event be regarded as a guarantee of conditions or characteristics. With respect to any examples or hints given herein, any typical values stated herein and/or any information regarding the application of the device, Infineon Technologies hereby disclaims any and all warranties and liabilities of any kind, including without limitation, warranties of non-infringement of intellectual property rights of any third party.

Information

For further information on technology, delivery terms and conditions and prices, please contact the nearest Infineon Technologies Office (www.infineon.com).

Warnings

Due to technical requirements, components may contain dangerous substances.
For information on the types in question, please contact the nearest Infineon Technologies Office.
Infineon Technologies components may be used in life-support devices or systems only with the express written approval of Infineon Technologies, if a failure of such components can reasonably be expected to cause the failure of that life-support device or system or to affect the safety or effectiveness of that device or system. Life support devices or systems are intended to be implanted in the human body or to support and/or maintain and sustain and/or protect human life.
If they fail, it is reasonable to assume that the health of the user or other persons may be endangered.

Revision History

Version	Date	Changes
Revision 1.0	23.07.2019	Final Data Sheet

单击下面可查看定价，库存，交付和生命周期等信息

[>>Infineon\(英飞凌\)](#)