

## Reverse Conducting Series

Reverse conducting IGBT with monolithic body diode

**IKW30N65WR5**

Data sheet

Industrial Power Control

Reverse conducting IGBT with monolithic body diode

**Features:**

- Powerful monolithic diode optimized for ZCS applications
- TRENCHSTOP™ 5 technology applications offers:
  - high ruggedness, temperature stable behavior
  - very low  $V_{CEsat}$  and low  $E_{off}$
  - easy parallel switching capability due to positive temperature coefficient in  $V_{CEsat}$
- Low EMI
- Low electrical parameters depending (dependence) on temperature
- Qualified according to JESD-022 for target applications
- Pb-free lead plating; RoHS compliant
- Complete product spectrum and PSpice Models:  
<http://www.infineon.com/igbt/>

**Applications:**

- Welding
- PFC
- ZCS - converters

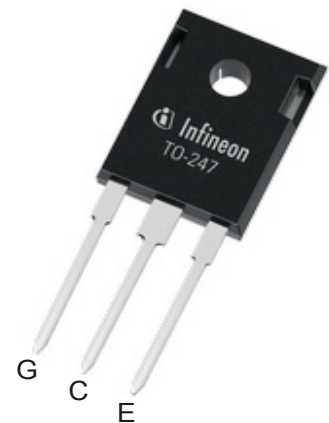
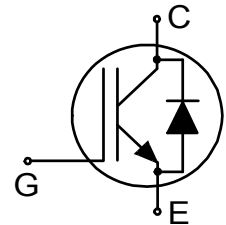

**Key Performance and Package Parameters**

| Type        | $V_{CE}$ | $I_C$ | $V_{CEsat}, T_{vj}=25^{\circ}C$ | $T_{vjmax}$ | Marking | Package    |
|-------------|----------|-------|---------------------------------|-------------|---------|------------|
| IKW30N65WR5 | 650V     | 30A   | 1.4V                            | 175°C       | K30EWR5 | PG-TO247-3 |



**Table of Contents**

Description ..... 2

Table of Contents ..... 3

Maximum Ratings ..... 4

Thermal Resistance ..... 4

Electrical Characteristics ..... 5

Electrical Characteristics Diagrams ..... 7

Package Drawing .....13

Testing Conditions .....14

Revision History .....15

Disclaimer .....15

**Maximum Ratings**

For optimum lifetime and reliability, Infineon recommends operating conditions that do not exceed 80% of the maximum ratings stated in this datasheet.

| Parameter  | Symbol      | Value         | Unit               |
|--|-------------|---------------|--------------------|
| Collector-emitter voltage, $T_{vj} \geq 25^{\circ}\text{C}$  | $V_{CE}$    | 650           | V                  |
| DC collector current, limited by $T_{vjmax}$<br>$T_C = 25^{\circ}\text{C}$<br>$T_C = 117^{\circ}\text{C}$            | $I_C$       | 60.0<br>30.0  | A                  |
| Pulsed collector current, $t_p$ limited by $T_{vjmax}$   | $I_{Cpuls}$ | 90.0          | A                  |
| Turn off safe operating area<br>$V_{CE} \leq 650\text{V}$ , $T_{vj} \leq 175^{\circ}\text{C}$ , $t_p = 1\mu\text{s}$ | -           | 90.0          | A                  |
| Diode forward current, limited by $T_{vjmax}$<br>$T_C = 25^{\circ}\text{C}$<br>$T_C = 100^{\circ}\text{C}$           | $I_F$       | 24.0<br>15.0  | A                  |
| Diode pulsed current, $t_p$ limited by $T_{vjmax}$   | $I_{Fpuls}$ | 45.0          | A                  |
| Gate-emitter voltage   | $V_{GE}$    | $\pm 20$      | V                  |
| Power dissipation $T_C = 25^{\circ}\text{C}$<br>Power dissipation $T_C = 117^{\circ}\text{C}$                        | $P_{tot}$   | 185.0<br>75.0 | W                  |
| Operating junction temperature   | $T_{vj}$    | -40...+175    | $^{\circ}\text{C}$ |
| Storage temperature  | $T_{stg}$   | -55...+150    | $^{\circ}\text{C}$ |
| Soldering temperature,<br>wave soldering 1.6mm (0.063in.) from case for 10s  |             | 260           | $^{\circ}\text{C}$ |
| Mounting torque, M3 screw<br>Maximum of mounting processes: 3  | $M$         | 0.6           | Nm                 |

**Thermal Resistance**

| Parameter                                    | Symbol        | Conditions | Max. Value | Unit |
|--|---------------|------------|------------|------|
| <b>Characteristic</b>                        |               |            |            |      |
| IGBT thermal resistance,<br>junction - case  | $R_{th(j-c)}$ |            | 0.81       | K/W  |
| Diode thermal resistance,<br>junction - case | $R_{th(j-c)}$ |            | 3.40       | K/W  |
| Thermal resistance<br>junction - ambient     | $R_{th(j-a)}$ |            | 40         | K/W  |

**Electrical Characteristic, at  $T_{vj} = 25^{\circ}\text{C}$ , unless otherwise specified**

| Parameter                            | Symbol        | Conditions   | Value  |              |           | Unit          |
|--------------------------------------|---------------|--|--------|--------------|-----------|---------------|
|                                      |               |  | min.   | typ.         | max.      |               |
| <b>Static Characteristic</b>         |               |  |        |              |           |               |
| Collector-emitter breakdown voltage  | $V_{(BR)CES}$ | $V_{GE} = 0\text{V}, I_C = 0.20\text{mA}$  | 650    | -            | -         | V             |
| Collector-emitter saturation voltage | $V_{CESat}$   | $V_{GE} = 15.0\text{V}, I_C = 30.0\text{A}$<br>$T_{vj} = 25^{\circ}\text{C}$<br>$T_{vj} = 175^{\circ}\text{C}$ | -<br>- | 1.40<br>1.65 | 1.80<br>- | V             |
| Diode forward voltage                | $V_F$         | $V_{GE} = 0\text{V}, I_F = 15.0\text{A}$<br>$T_{vj} = 25^{\circ}\text{C}$<br>$T_{vj} = 175^{\circ}\text{C}$    | -<br>- | 1.40<br>1.50 | 1.90<br>- | V             |
| Gate-emitter threshold voltage       | $V_{GE(th)}$  | $I_C = 0.30\text{mA}, V_{CE} = V_{GE}$   | 3.2    | 4.0          | 4.8       | V             |
| Zero gate voltage collector current  | $I_{CES}$     | $V_{CE} = 650\text{V}, V_{GE} = 0\text{V}$<br>$T_{vj} = 25^{\circ}\text{C}$<br>$T_{vj} = 175^{\circ}\text{C}$  | -<br>- | -<br>-       | 40<br>-   | $\mu\text{A}$ |
| Gate-emitter leakage current         | $I_{GES}$     | $V_{CE} = 0\text{V}, V_{GE} = 20\text{V}$  | -      | -            | 100       | nA            |
| Transconductance                     | $g_{fs}$      | $V_{CE} = 20\text{V}, I_C = 30.0\text{A}$  | -      | 35.0         | -         | S             |
| Integrated gate resistor             | $r_G$         |  |        | none         |           | $\Omega$      |

**Electrical Characteristic, at  $T_{vj} = 25^{\circ}\text{C}$ , unless otherwise specified**

| Parameter  | Symbol    | Conditions   | Value |       |      | Unit |
|--|-----------|--|-------|-------|------|------|
|  |           |  | min.  | typ.  | max. |      |
| <b>Dynamic Characteristic</b>                                  |           |  |       |       |      |      |
| Input capacitance  | $C_{ies}$ | $V_{CE} = 25\text{V}, V_{GE} = 0\text{V}, f = 1\text{MHz}$           | -     | 3700  | -    | pF   |
| Output capacitance   | $C_{oes}$ |  | -     | 35    | -    |      |
| Reverse transfer capacitance                                   | $C_{res}$ |  | -     | 16    | -    |      |
| Gate charge  | $Q_G$     | $V_{CC} = 520\text{V}, I_C = 30.0\text{A},$<br>$V_{GE} = 15\text{V}$ | -     | 155.0 | -    | nC   |
| Internal emitter inductance measured 5mm (0.197 in.) from case | $L_E$     |  | -     | 13.0  | -    | nH   |

**Switching Characteristic, Inductive Load**

| Parameter | Symbol | Conditions | Value |      |      | Unit |
|-----------|--------|------------|-------|------|------|------|
|           |        |            | min.  | typ. | max. |      |

**IGBT Characteristic, at  $T_{vj} = 25^{\circ}\text{C}$** 

|                        |              |   |   |      |   |    |
|------------------------|--------------|---|---|------|---|----|
| Turn-on delay time     | $t_{d(on)}$  | $T_{vj} = 25^{\circ}\text{C},$<br>$V_{CC} = 400\text{V}, I_C = 15.0\text{A},$<br>$V_{GE} = 0.0/15.0\text{V},$<br>$R_{G(on)} = 26.0\Omega, R_{G(off)} = 26.0\Omega,$<br>$L_{\sigma} = 45\text{nH}, C_{\sigma} = 32\text{pF}$<br>$L_{\sigma}, C_{\sigma}$ from Fig. E<br>Energy losses include "tail" and diode reverse recovery. | - | 39   | - | ns |
| Rise time              | $t_r$        |   | - | 12   | - | ns |
| Turn-off delay time    | $t_{d(off)}$ |   | - | 367  | - | ns |
| Fall time              | $t_f$        |   | - | 9    | - | ns |
| Turn-on energy         | $E_{on}$     |   | - | 0.99 | - | mJ |
| Turn-off energy        | $E_{off}$    |   | - | 0.33 | - | mJ |
| Total switching energy | $E_{ts}$     |   | - | 1.32 | - | mJ |

**Diode Characteristic, at  $T_{vj} = 25^{\circ}\text{C}$** 

|  |              |   |   |      |   |                        |
|--|--------------|---|---|------|---|------------------------|
| Diode reverse recovery time                                      | $t_{rr}$     | $T_{vj} = 25^{\circ}\text{C}$ ,<br>$V_R = 400\text{V}$ ,<br>$I_F = 15.0\text{A}$ ,<br>$di_F/dt = 900\text{A}/\mu\text{s}$ | - | 95   | - | ns                     |
| Diode reverse recovery charge                                    | $Q_{rr}$     |   | - | 1.25 | - | $\mu\text{C}$          |
| Diode peak reverse recovery current                              | $I_{rrm}$    |   | - | 22.0 | - | A                      |
| Diode peak rate of fall of reverse recovery current during $t_b$ | $di_{rr}/dt$ |   | - | -590 | - | $\text{A}/\mu\text{s}$ |

**Switching Characteristic, Inductive Load**

| Parameter | Symbol | Conditions | Value |      |      | Unit |
|-----------|--------|------------|-------|------|------|------|
|           |        |            | min.  | typ. | max. |      |

**IGBT Characteristic, at  $T_{vj} = 175^{\circ}\text{C}$** 

|                        |                     |  |   |      |   |    |
|------------------------|---------------------|--|---|------|---|----|
| Turn-on delay time     | $t_{d(\text{on})}$  | $T_{vj} = 175^{\circ}\text{C}$ ,<br>$V_{CC} = 400\text{V}$ , $I_C = 15.0\text{A}$ ,<br>$V_{GE} = 0.0/15.0\text{V}$ ,<br>$R_{G(\text{on})} = 26.0\Omega$ , $R_{G(\text{off})} = 26.0\Omega$ ,<br>$L\sigma = 45\text{nH}$ , $C\sigma = 32\text{pF}$<br>$L\sigma$ , $C\sigma$ from Fig. E<br>Energy losses include "tail" and diode reverse recovery. | - | 35   | - | ns |
| Rise time              | $t_r$               |  | - | 14   | - | ns |
| Turn-off delay time    | $t_{d(\text{off})}$ |  | - | 423  | - | ns |
| Fall time              | $t_f$               |  | - | 6    | - | ns |
| Turn-on energy         | $E_{\text{on}}$     |  | - | 1.09 | - | mJ |
| Turn-off energy        | $E_{\text{off}}$    |  | - | 0.46 | - | mJ |
| Total switching energy | $E_{\text{ts}}$     |  | - | 1.55 | - | mJ |

**Diode Characteristic, at  $T_{vj} = 175^{\circ}\text{C}$** 

|  |              |  |   |       |   |                        |
|--|--------------|--|---|-------|---|------------------------|
| Diode reverse recovery time                                      | $t_{rr}$     | $T_{vj} = 175^{\circ}\text{C}$ ,<br>$V_R = 400\text{V}$ ,<br>$I_F = 15.0\text{A}$ ,<br>$di_F/dt = 900\text{A}/\mu\text{s}$ | - | 121   | - | ns                     |
| Diode reverse recovery charge                                    | $Q_{rr}$     |  | - | 2.15  | - | $\mu\text{C}$          |
| Diode peak reverse recovery current                              | $I_{rrm}$    |  | - | 28.0  | - | A                      |
| Diode peak rate of fall of reverse recovery current during $t_b$ | $di_{rr}/dt$ |  | - | -1100 | - | $\text{A}/\mu\text{s}$ |

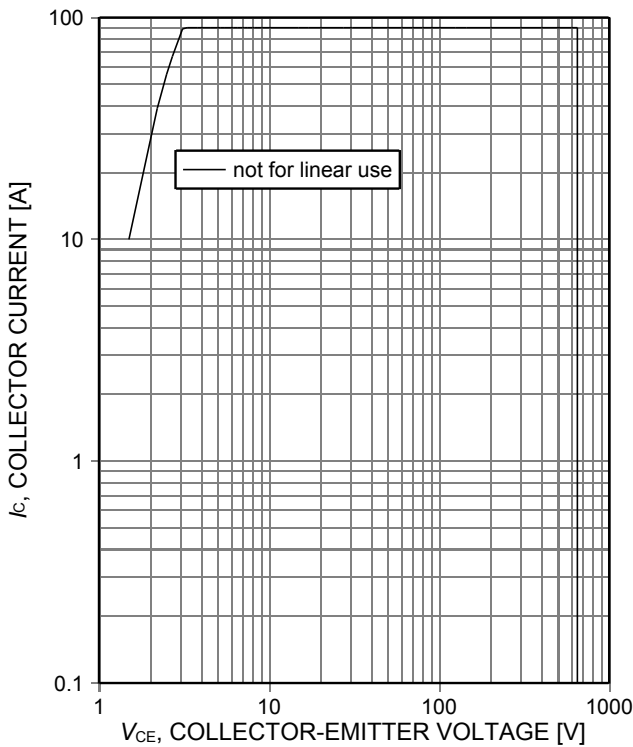

Figure 1. **Forward bias safe operating area**  
 ( $D=0$ ,  $T_C=25^\circ\text{C}$ ,  $T_{vj}\leq 175^\circ\text{C}$ ,  $V_{GE}=15\text{V}$ ,  $t_p=1\mu\text{s}$ )

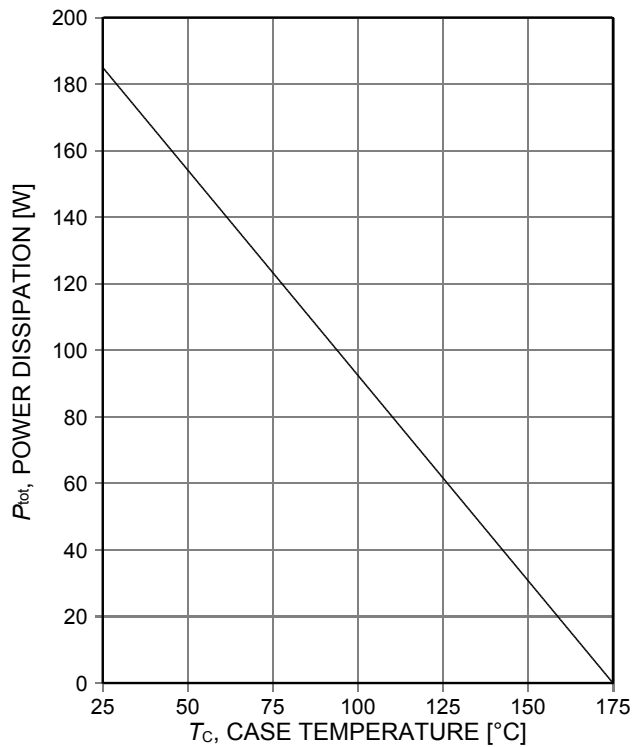

Figure 2. **Power dissipation as a function of case temperature**  
 ( $T_{vj}\leq 175^\circ\text{C}$ )

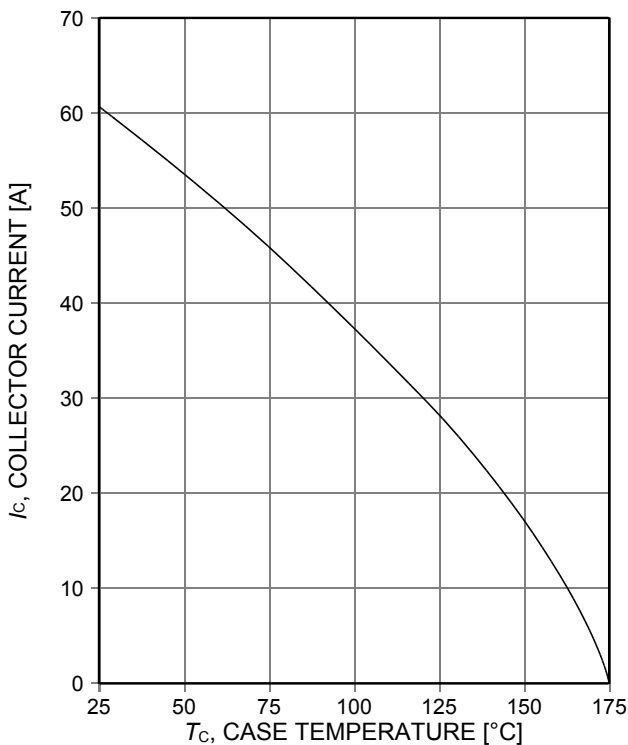

Figure 3. **Collector current as a function of case temperature**  
 ( $V_{GE}\geq 15\text{V}$ ,  $T_{vj}\leq 175^\circ\text{C}$ )

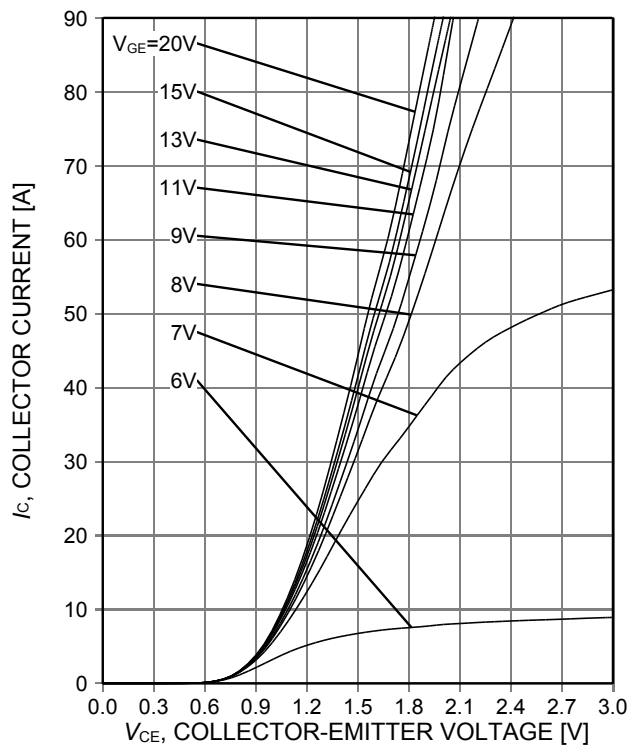

Figure 4. **Typical output characteristic**  
 ( $T_{vj}=25^\circ\text{C}$ )

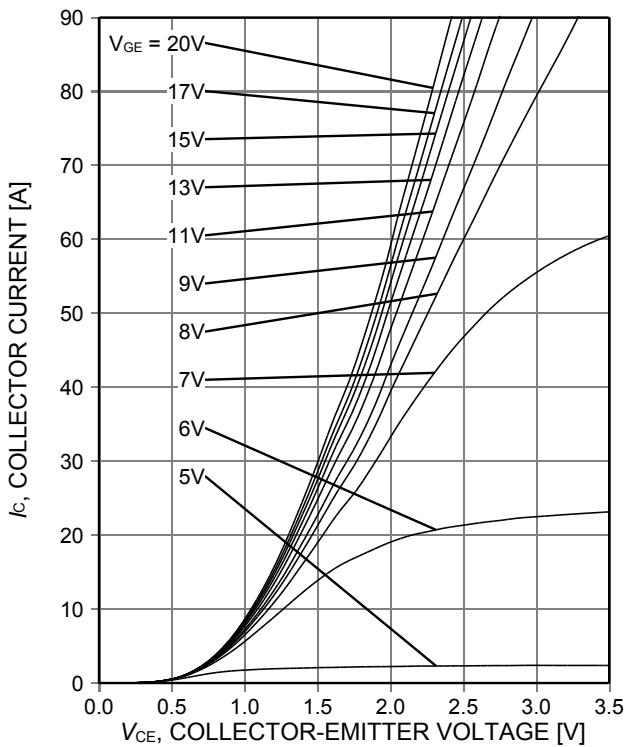

Figure 5. **Typical output characteristic**  
( $T_{vj}=175^{\circ}\text{C}$ )

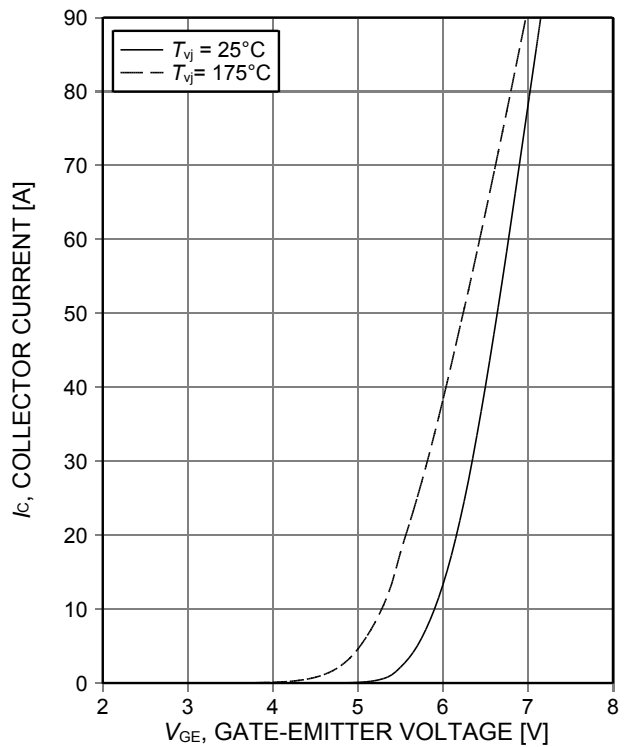

Figure 6. **Typical transfer characteristic**  
( $V_{CE}=20\text{V}$ )

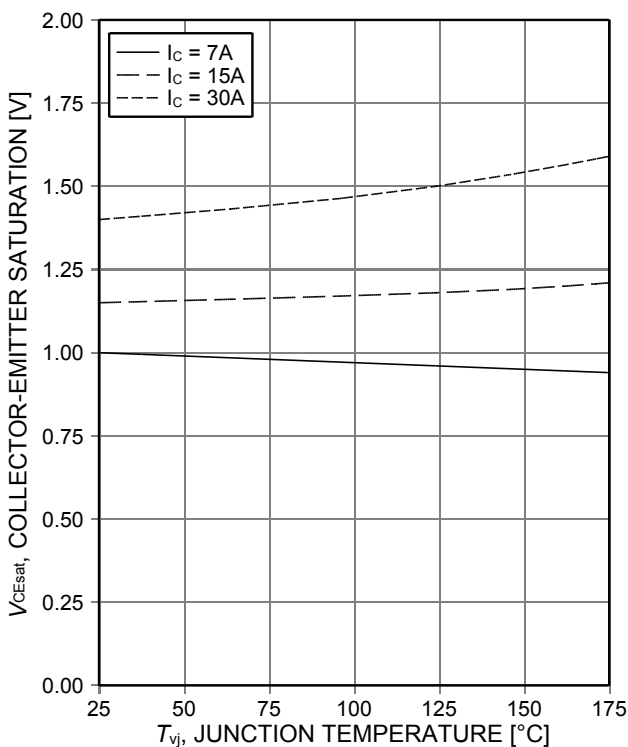

Figure 7. **Typical collector-emitter saturation voltage as a function of junction temperature**  
( $V_{GE}=15\text{V}$ )

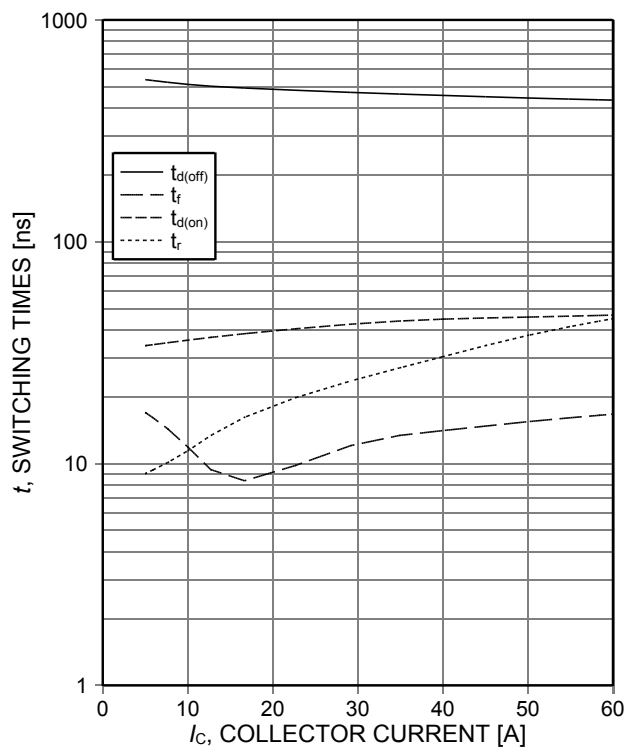

Figure 8. **Typical switching times as a function of collector current**  
(inductive load,  $T_{vj}=175^{\circ}\text{C}$ ,  $V_{CE}=400\text{V}$ ,  $V_{GE}=0/15\text{V}$ ,  $R_{G(on)}=26\Omega$ ,  $R_{G(off)}=26\Omega$ , dynamic test circuit in Figure E)



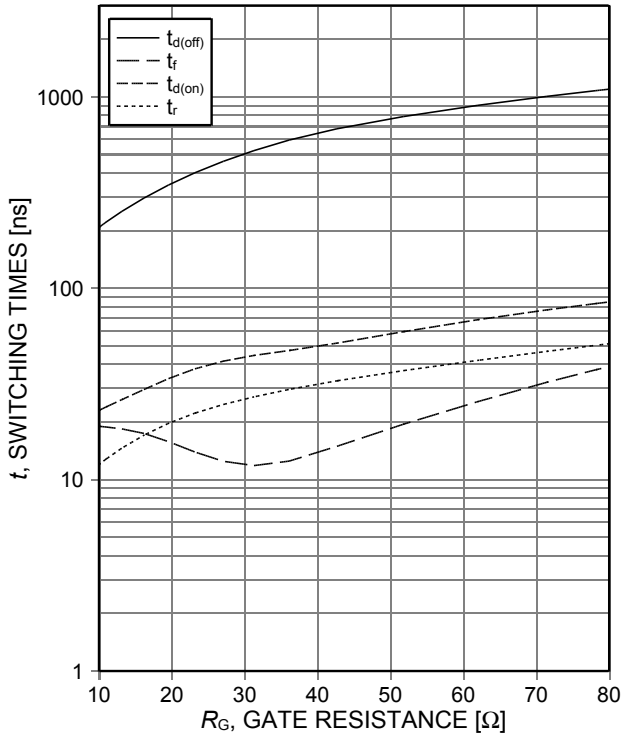

Figure 9. **Typical switching times as a function of gate resistance**  
 (inductive load,  $T_{vj}=175^{\circ}\text{C}$ ,  $V_{CE}=400\text{V}$ ,  $V_{GE}=0/15\text{V}$ ,  $I_C=30\text{A}$ , dynamic test circuit in Figure E)

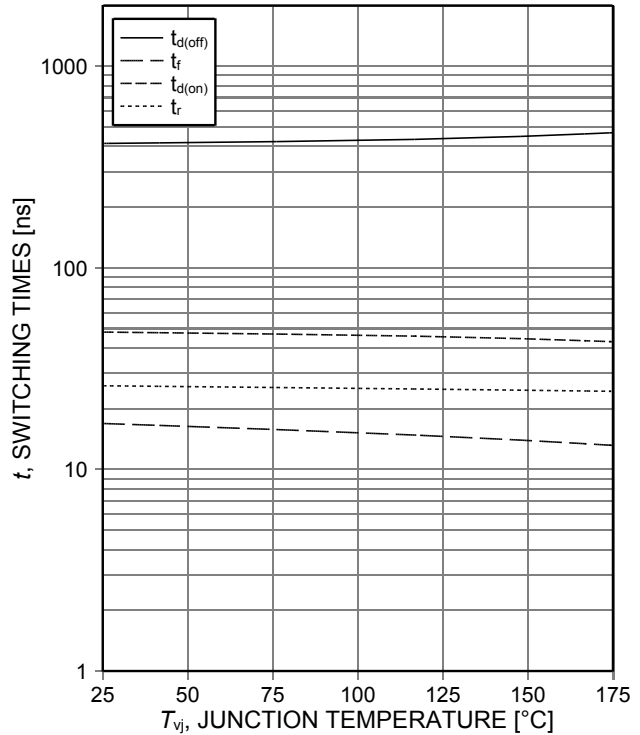

Figure 10. **Typical switching times as a function of junction temperature**  
 (inductive load,  $V_{CE}=400\text{V}$ ,  $V_{GE}=0/15\text{V}$ ,  $I_C=30\text{A}$ ,  $R_{G(on)}=26\Omega$ ,  $R_{G(off)}=26\Omega$ , dynamic test circuit in Figure E)

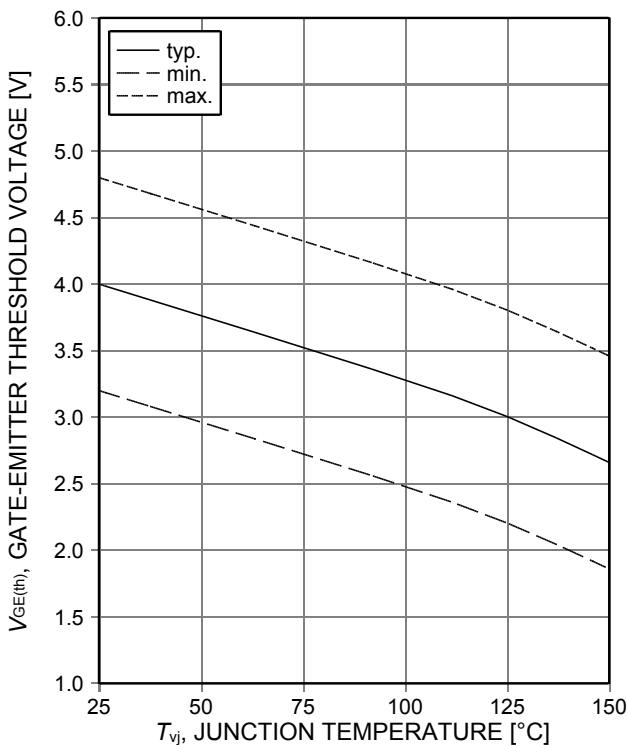

Figure 11. **Gate-emitter threshold voltage as a function of junction temperature**  
 ( $I_C=0.3\text{mA}$ )

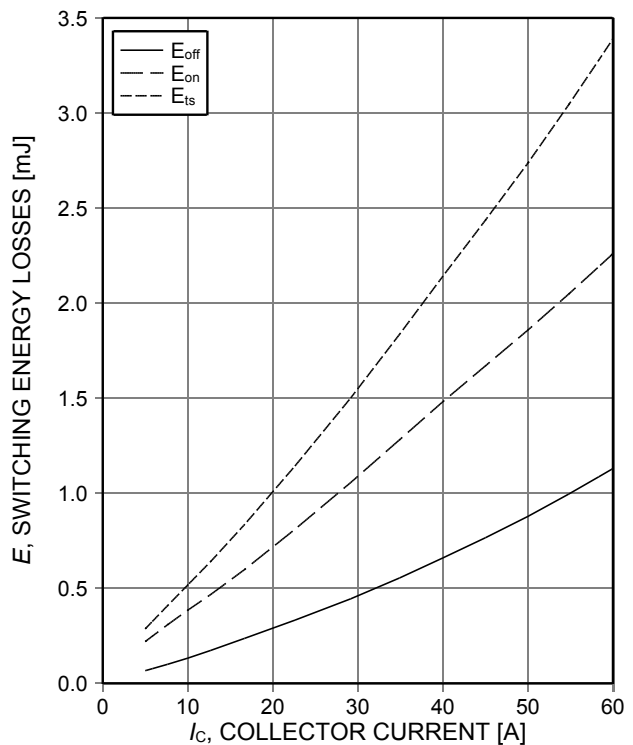

Figure 12. **Typical switching energy losses as a function of collector current**  
 (inductive load,  $T_{vj}=175^{\circ}\text{C}$ ,  $V_{CE}=400\text{V}$ ,  $V_{GE}=0/15\text{V}$ ,  $R_{G(on)}=26\Omega$ ,  $R_{G(off)}=26\Omega$ , dynamic test circuit in Figure E)

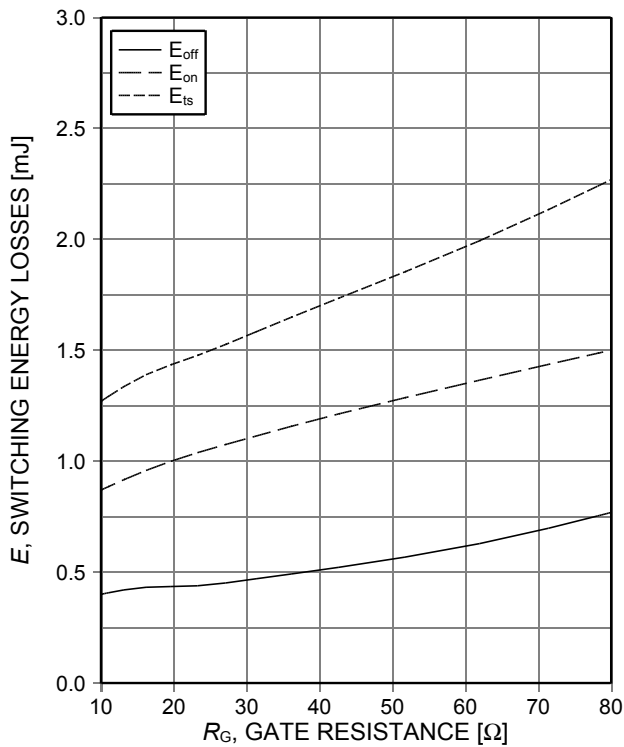

Figure 13. Typical switching energy losses as a function of gate resistance (inductive load,  $T_{vj}=175^{\circ}\text{C}$ ,  $V_{CE}=400\text{V}$ ,  $V_{GE}=0/15\text{V}$ ,  $I_C=30\text{A}$ , dynamic test circuit in Figure E)

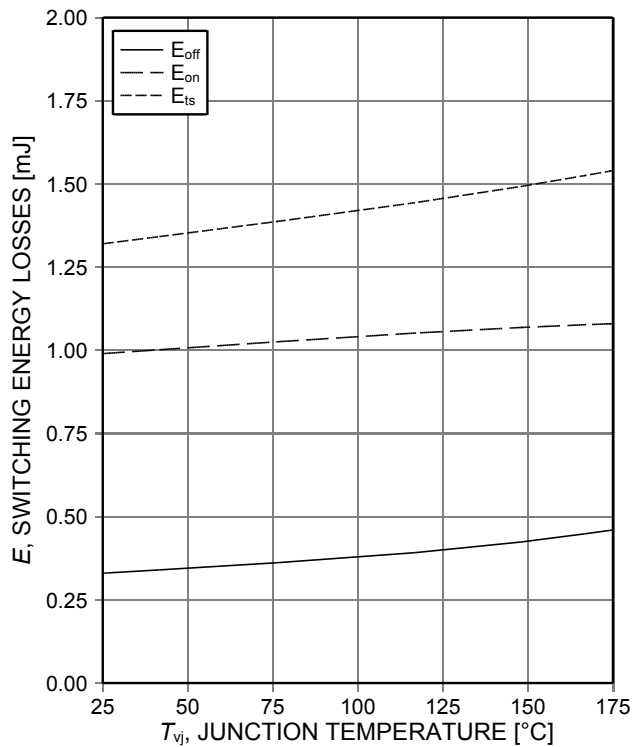

Figure 14. Typical switching energy losses as a function of junction temperature (inductive load,  $V_{CE}=400\text{V}$ ,  $V_{GE}=0/15\text{V}$ ,  $I_C=30\text{A}$ ,  $R_{G(on)}=26\Omega$ ,  $R_{G(off)}=26\Omega$ , dynamic test circuit in Figure E)

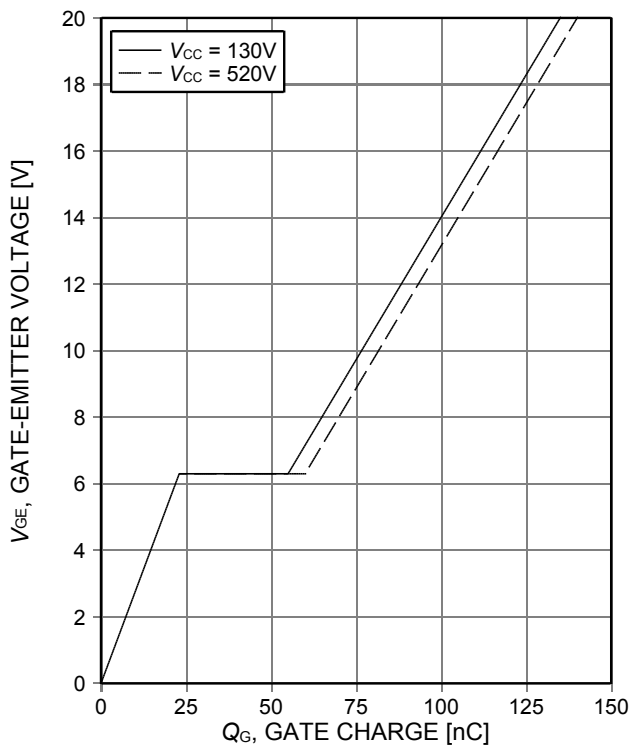

Figure 15. Typical gate charge ( $I_C=30\text{A}$ )

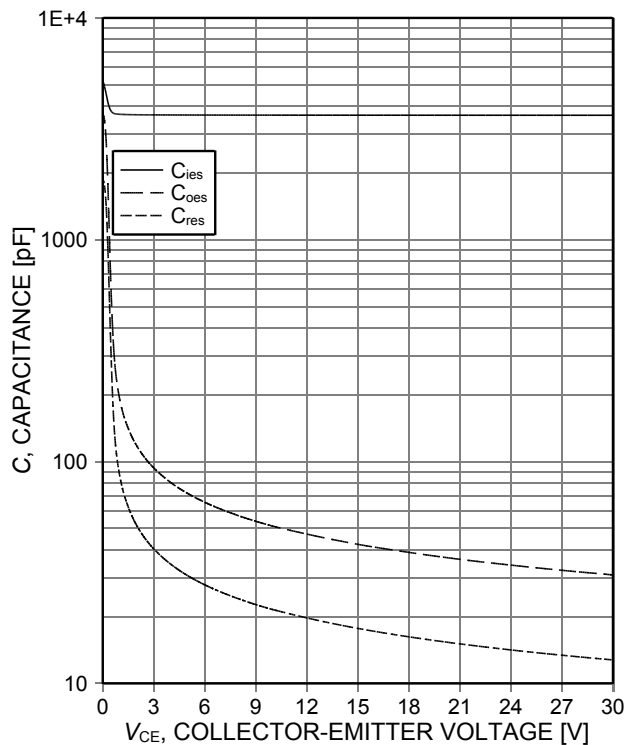

Figure 16. Typical capacitance as a function of collector-emitter voltage ( $V_{GE}=0\text{V}$ ,  $f=1\text{MHz}$ )

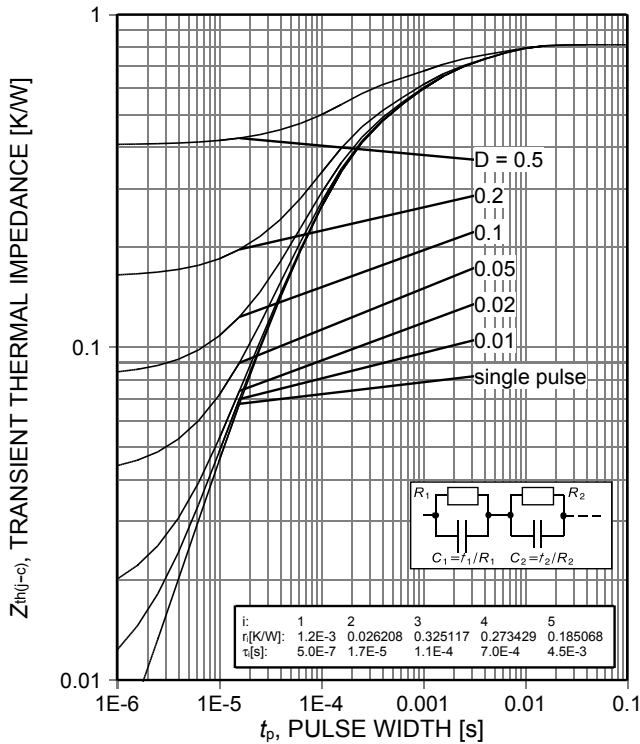

Figure 17. IGBT transient thermal impedance as a function of pulse width ( $D=t_p/T$ )

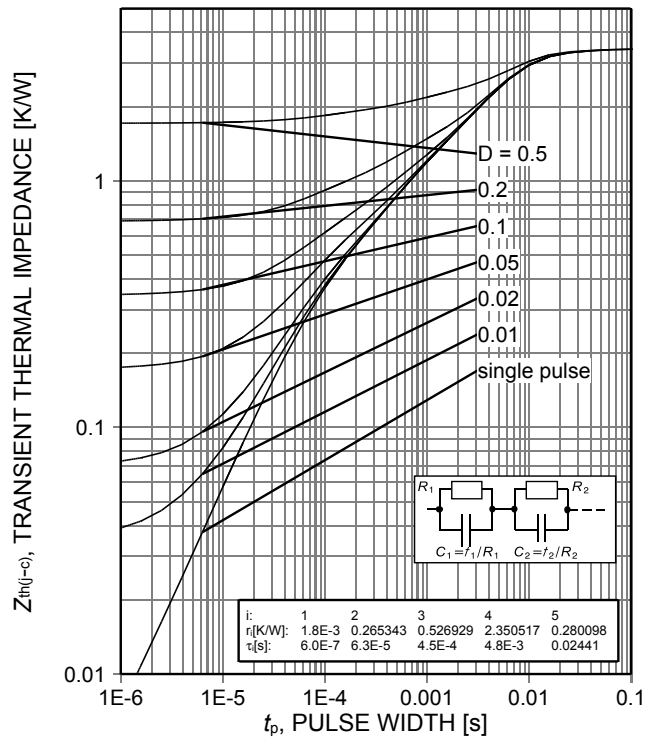

Figure 18. Diode transient thermal impedance as a function of pulse width ( $D=t_p/T$ )

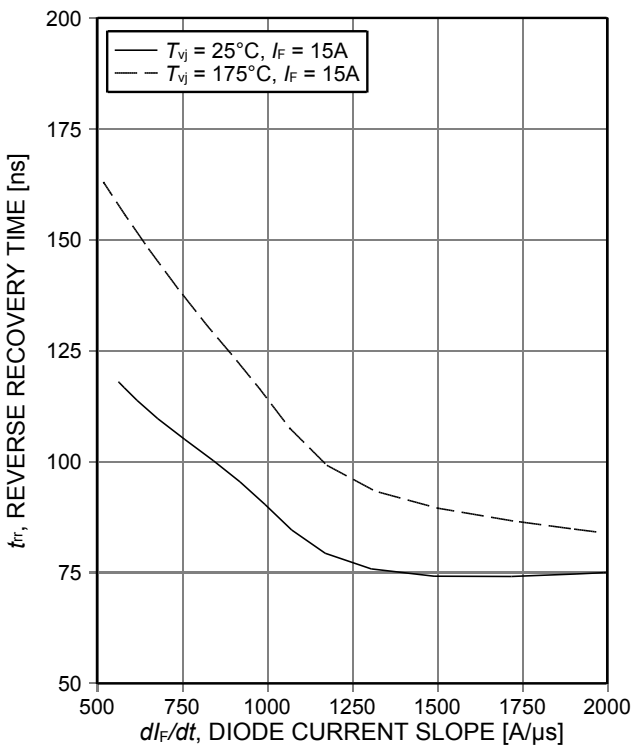

Figure 19. Typical reverse recovery time as a function of diode current slope ( $V_R=400V$ )

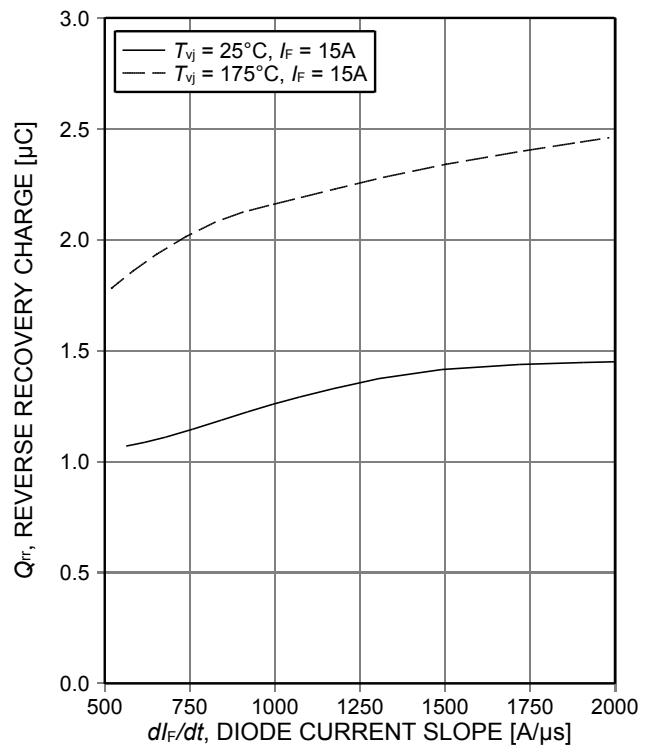

Figure 20. Typical reverse recovery charge as a function of diode current slope ( $V_R=400V$ )

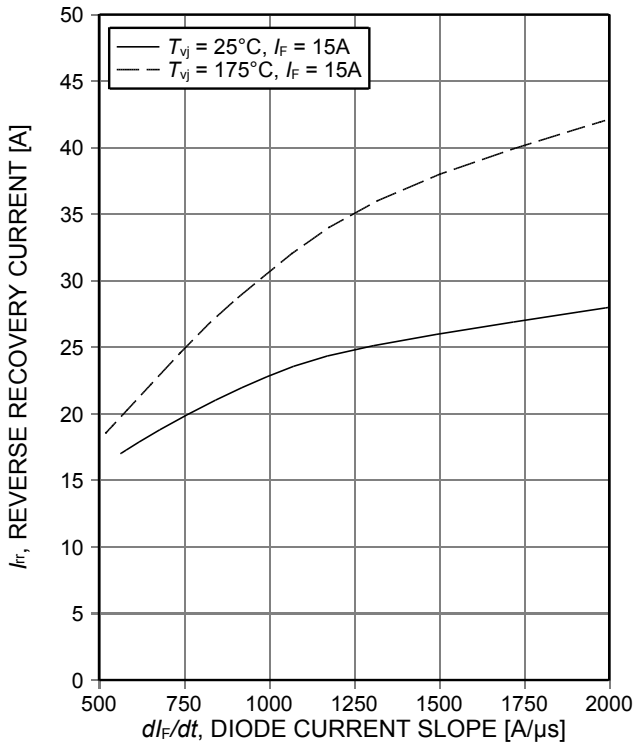

Figure 21. Typical reverse recovery current as a function of diode current slope ( $V_R=400V$ )

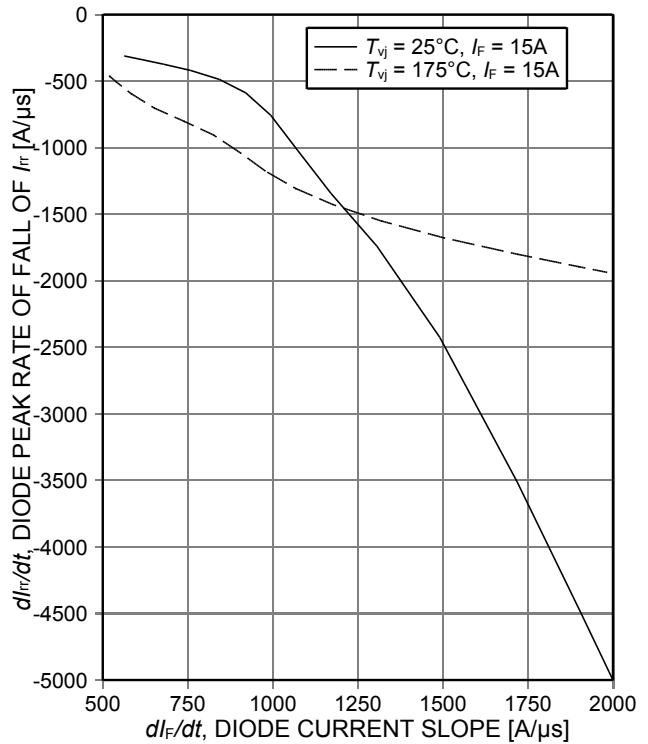

Figure 22. Typical diode peak rate of fall of reverse recovery current as a function of diode current slope ( $V_R=400V$ )

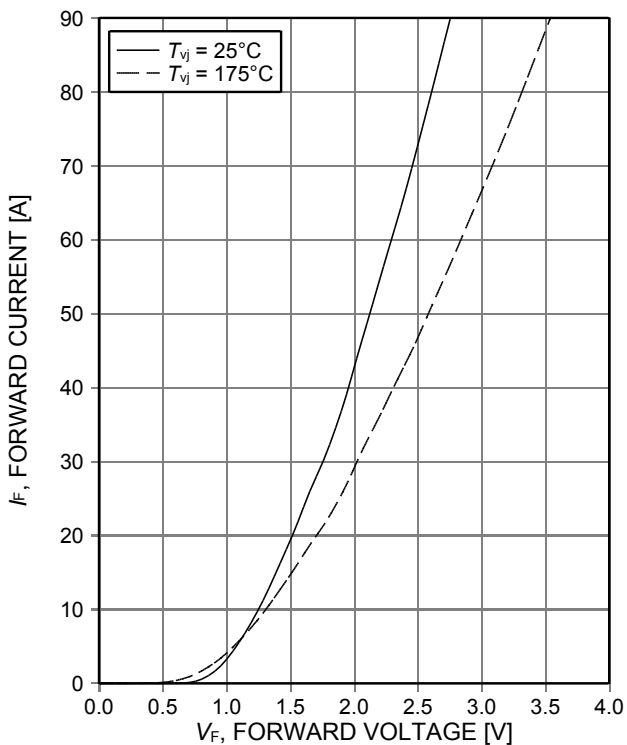

Figure 23. Typical diode forward current as a function of forward voltage

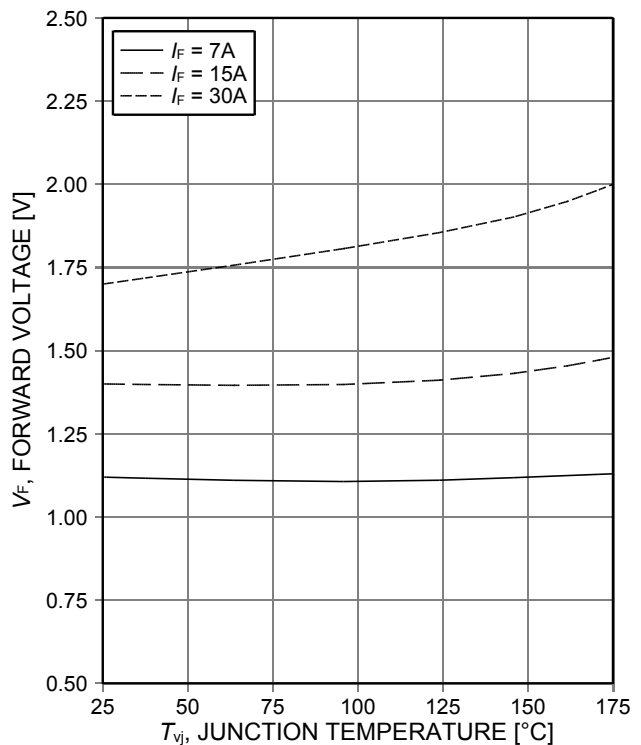
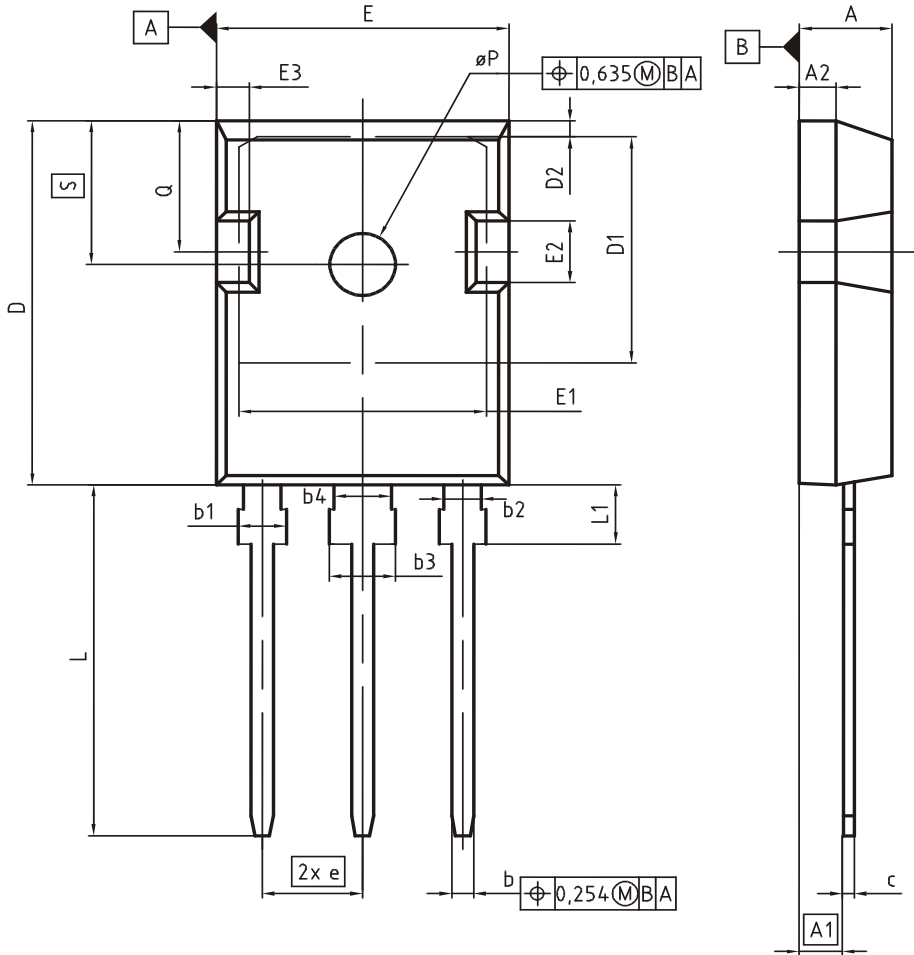

Figure 24. Typical diode forward voltage as a function of junction temperature

Package Drawing PG-TO247-3



| DIM      | MILLIMETERS |       | INCHES      |       |
|----------|-------------|-------|-------------|-------|
|          | MIN         | MAX   | MIN         | MAX   |
| A        | 4.83        | 5.21  | 0.190       | 0.205 |
| A1       | 2.27        | 2.54  | 0.089       | 0.100 |
| A2       | 1.85        | 2.16  | 0.073       | 0.085 |
| b        | 1.07        | 1.33  | 0.042       | 0.052 |
| b1       | 1.90        | 2.41  | 0.075       | 0.095 |
| b2       | 1.90        | 2.16  | 0.075       | 0.085 |
| b3       | 2.87        | 3.38  | 0.113       | 0.133 |
| b4       | 2.87        | 3.13  | 0.113       | 0.123 |
| c        | 0.55        | 0.68  | 0.022       | 0.027 |
| D        | 20.80       | 21.10 | 0.819       | 0.831 |
| D1       | 16.25       | 17.65 | 0.640       | 0.695 |
| D2       | 0.95        | 1.35  | 0.037       | 0.053 |
| E        | 15.70       | 16.13 | 0.618       | 0.635 |
| E1       | 13.10       | 14.15 | 0.516       | 0.557 |
| E2       | 3.68        | 5.10  | 0.145       | 0.201 |
| E3       | 1.00        | 2.60  | 0.039       | 0.102 |
| e        | 5.44 (BSC)  |       | 0.214 (BSC) |       |
| N        | 3           |       | 3           |       |
| L        | 19.80       | 20.32 | 0.780       | 0.800 |
| L1       | 4.10        | 4.47  | 0.161       | 0.176 |
| $\phi P$ | 3.50        | 3.70  | 0.138       | 0.146 |
| Q        | 5.49        | 6.00  | 0.216       | 0.236 |
| S        | 6.04        | 6.30  | 0.238       | 0.248 |

DOCUMENT NO.  
Z8B00003327

SCALE  
0 5 5 7.5mm

EUROPEAN PROJECTION

ISSUE DATE  
09-07-2010

REVISION  
05

Testing Conditions

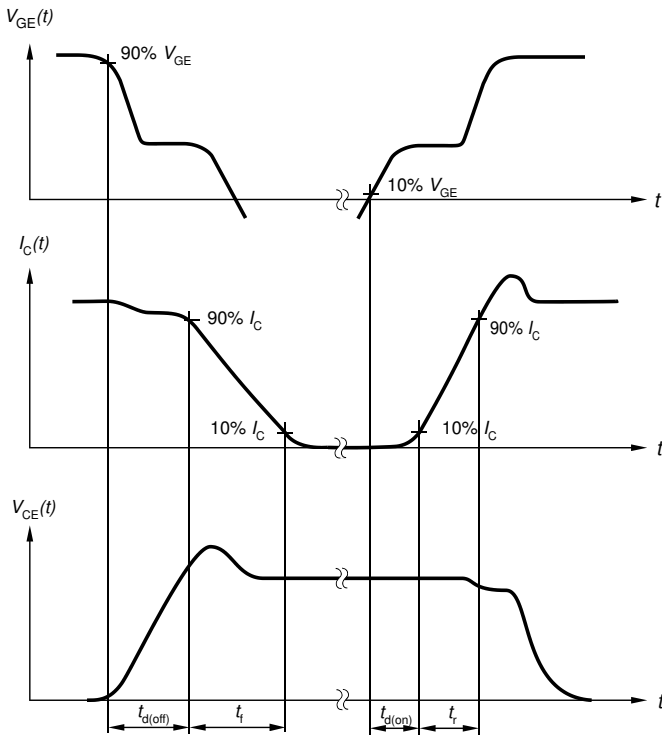

Figure A. Definition of switching times

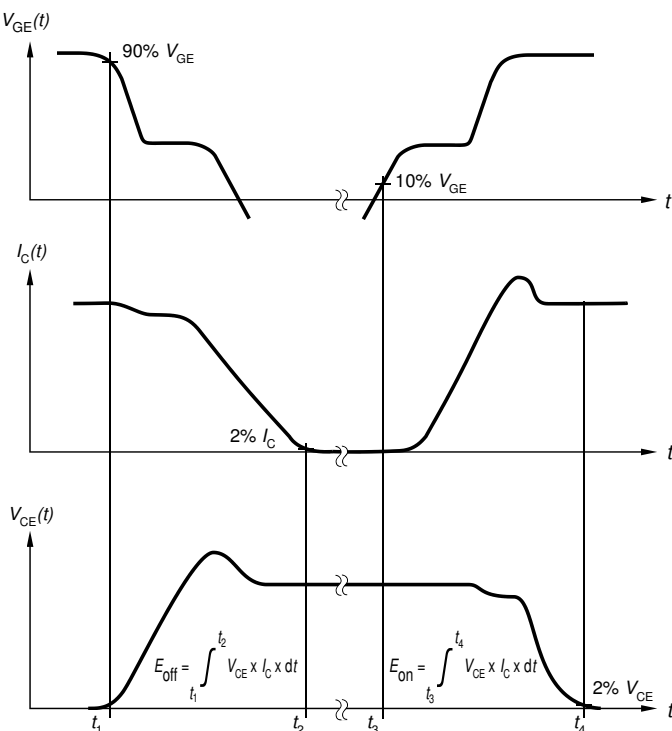

Figure B. Definition of switching losses

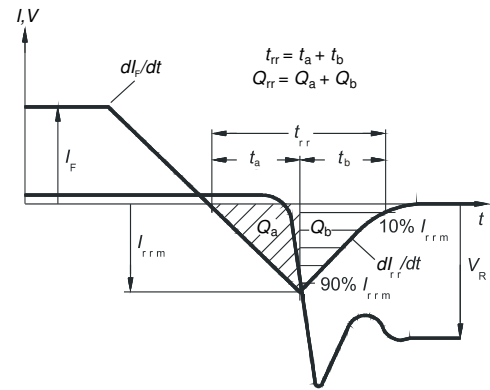

Figure C. Definition of diode switching characteristics

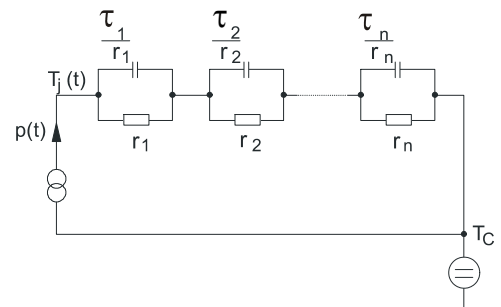

Figure D. Thermal equivalent circuit

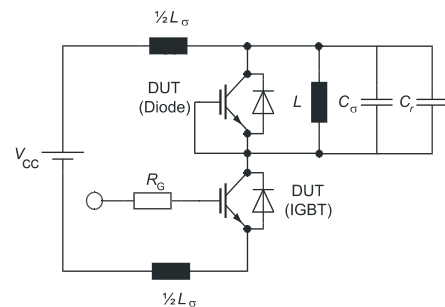

Figure E. Dynamic test circuit  
Parasitic inductance  $L_{\sigma}$ ,  
parasitic capacitor  $C_{\sigma}$ ,  
relief capacitor  $C_r$ ,  
(only for ZVT switching)

**Revision History**

IKW30N65WR5

**Revision: 2015-12-10, Rev. 2.1**

Previous Revision

| Revision | Date       | Subjects (major changes since last revision) |
|----------|------------|--|
| 1.1      | 2015-04-23 | Preliminary data sheet                       |
| 1.2      | 2015-05-12 | Minor change Figure 3                        |
| 1.3      | 2015-06-01 | Update Figure 14 E(T)                        |
| 2.1      | 2015-12-10 | Final data sheet                             |

**Published by**  
**Infineon Technologies AG**  
**81726 München, Germany**  
**© Infineon Technologies AG 2015.**  
**All Rights Reserved.**

**Important Notice**

The information given in this document shall in no event be regarded as a guarantee of conditions or characteristics ("Beschaffenheitsgarantie"). With respect to any examples, hints or any typical values stated herein and/or any information regarding the application of the product, Infineon Technologies hereby disclaims any and all warranties and liabilities of any kind, including without limitation warranties of non-infringement of intellectual property rights of any third party.

In addition, any information given in this document is subject to customer's compliance with its obligations stated in this document and any applicable legal requirements, norms and standards concerning customer's products and any use of the product of Infineon Technologies in customer's applications.

The data contained in this document is exclusively intended for technically trained staff. It is the responsibility of customer's technical departments to evaluate the suitability of the product for the intended application and the completeness of the product information given in this document with respect to such application.

For further information on the product, technology, delivery terms and conditions and prices please contact your nearest Infineon Technologies office ([www.infineon.com](http://www.infineon.com)).

Please note that this product is not qualified according to the AEC Q100 or AEC Q101 documents of the Automotive Electronics Council.

**Warnings**

Due to technical requirements products may contain dangerous substances. For information on the types in question please contact your nearest Infineon Technologies office.

Except as otherwise explicitly approved by Infineon Technologies in a written document signed by authorized representatives of Infineon Technologies, Infineon Technologies' products may not be used in any applications where a failure of the product or any consequences of the use thereof can reasonably be expected to result in personal injury.

单击下面可查看定价，库存，交付和生命周期等信息

[>>Infineon Technologies\(英飞凌\)](#)