

Quasi-Resonant 800 V CoolSET™ - in DSO-12 Package

Product Highlights

- Integrated 800 V avalanche rugged CoolMOS™
- Novel Quasi-Resonant operation and proprietary implementation for low EMI
- Enhanced Active Burst Mode with selectable entry and exit standby power
- Active Burst Mode to reach the lowest standby power <100 mW
- Fast startup achieved with cascode configuration
- Digital frequency reduction for better overall system efficiency
- Robust line protection with input OVP and brownout
- Comprehensive protection
- Pb-free lead plating, halogen free mold compound, RoHS compliant



Features

- Integrated 800 V avalanche rugged CoolMOS™
- Minimum switching frequency difference between low & high line for higher efficiency & better EMI
- Enhanced Active Burst Mode with selectable entry and exit standby power
- Active Burst Mode to reach the lowest standby power <100 mW
- Fast startup achieved with cascode configuration
- Digital frequency reduction up to 10 zero crossings
- Built-in digital soft start
- Cycle-by-cycle peak current limitation
- Maximum on/off time limitation to avoid audible noise during start up and power down
- Robust line protection with input OVP and brownout
- Auto restart mode protection for VCC Over Voltage, VCC Under Voltage, Over load/Open Loop, Line/Output Over Voltage, Over Temperature
- Limited charging current for VCC short to GND
- Pb-free lead plating, halogen free mold compound, RoHS compliant

Applications

- Auxiliary power supply for Home Appliances/white Goods, TV, PC & Server
- Blu-ray player, Set-top box & LCD/LED Monitor

Description

The Quasi-Resonant CoolSET™- (ICE5QRxx80BG) is the 5th generation of Quasi-Resonant integrated power IC optimized for off-line switch power supply in cascode configuration. It is housed in single package with 2 separate chips; one is controller chip and other is HV MOSFET chips. The IC can achieve lower EMI and higher efficiency with improved digital frequency reduction through the proprietary novel Quasi-Resonant operation. The enhanced Active Burst Mode enables flexibility in standby power range selection. The product has a wide operation range (10 ~ 25.5 V) of IC power supply and lower power consumption. The numerous protection functions including the robust line protection (both input OVP and brownout) to support the protections of the power supply system in failure situations. All of these make the CoolSET™ (ICE5QRxx80BG) series an outstanding integrated power device in Quasi-Resonant flyback converter in the market.

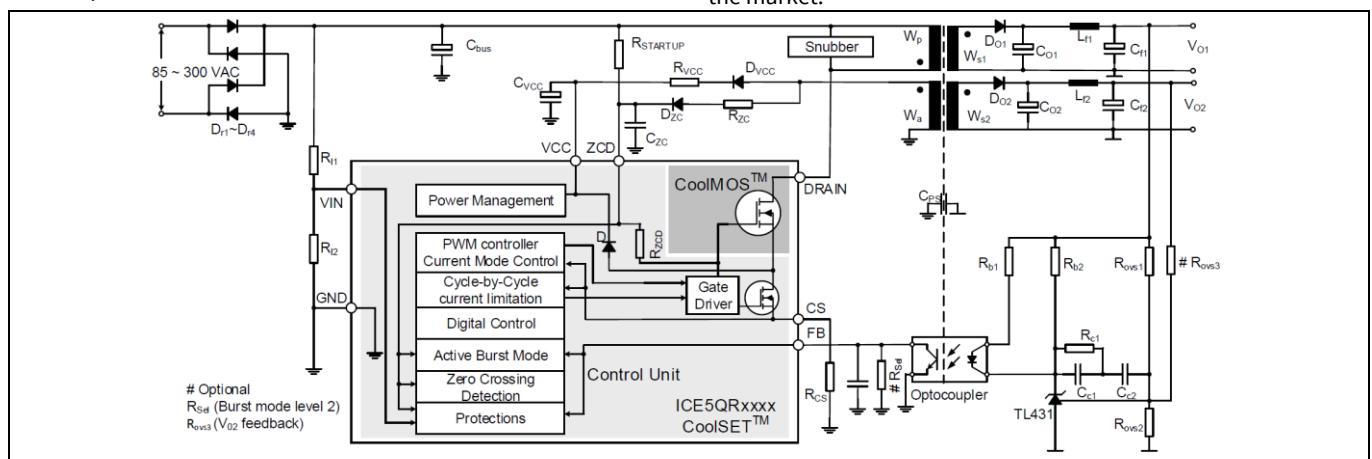

Figure 1 Typical application

Output Power of 5th generation Quasi-Resonant CoolSET™

Output Power of 5th generation Quasi-Resonant CoolSET™

Table 1 Output Power of 5th generation Quasi-Resonant CoolSET™

Type	Package	Marking	V _{DS}	R _{DSon} ¹	220V _{AC} ±20% ²	85-300 V _{AC} ²
ICE5QR4780BG	PG-DSO-12	5QR4780BG	800 V	4.13 Ω	28 W	15 W
ICE5QR2280BG	PG-DSO-12	5QR2280BG	800 V	2.13 Ω	42 W	23 W
ICE5QR1680BG	PG-DSO-12	5QR1680BG	800 V	1.53 Ω	50 W	27 W
ICE5QR0680BG	PG-DSO-12	5QR0680BG	800 V	0.71 Ω	77 W	42 W

¹ Typ. at T_J = 25°C (inclusive of low side MOSFET)

² Calculated maximum output power rating in an open frame design at T_a = 50°C, T_J = 125°C (integrated high voltage MOSFET) and using minimum drain pin copper area in a 2 oz copper single sided PCB. The output power figure is for selection purpose only. The actual power can vary depending on particular designs. Please contact to a technical expert from Infineon for more information.

Table of Contents

Table of Contents

Product Highlights..... 1

Features 1

Applications..... 1

Description 1

Output Power of 5th generation Quasi-Resonant CoolSET™ 2

Table of Contents 3

1 Pin Configuration and Functionality..... 5

2 Representative Block Diagram..... 6

3 Functional Description..... 7

3.1 V_{CC} Pre-Charging and Typical V_{CC} Voltage during Start-up..... 7

3.2 Soft-start..... 7

3.3 Normal Operation 8

3.3.1 Digital Frequency Reduction 8

3.3.1.1 Minimum ZC Count Determination 8

3.3.1.2 Up/down counter..... 8

3.3.1.3 Zero crossing (ZC counter) 9

3.3.2 Ringing suppression time 10

3.3.2.1 Switch on determination 10

3.3.3 Switch off determination 10

3.3.4 Modulated gate drive 11

3.4 Current limitation..... 11

3.5 Active Burst Mode with selectable power level..... 12

3.5.1 Entering Active Burst Mode Operation 13

3.5.2 During Active Burst Mode Operation 13

3.5.3 Leaving Active Burst Mode Operation 13

3.6 Protection Functions..... 14

3.6.1 Line Over Voltage 15

3.6.2 Brownout..... 15

3.6.3 V_{CC} Over Voltage or Under Voltage..... 15

3.6.4 Over Load 15

3.6.5 Output Over Voltage 15

3.6.6 Over Temperature..... 15

4 Electrical Characteristics 18

4.1 Absolute Maximum Ratings 18

4.2 Operating Range..... 19

4.3 Operating Conditions..... 19

4.4 Internal Voltage Reference..... 20

4.5 PWM Section..... 20

4.6 Current Sense 20

4.7 Soft Start..... 21

4.8 Digital Zero Crossing 21

4.9 Active Burst Mode..... 22

4.10 Line Over Voltage Protection 22

4.11 Brownout Protection..... 22

4.12 V_{CC} Over Voltage Protection 22

4.13 Over Load Protection 23



Table of Contents

4.14	Output Over Voltage Protection	23
4.15	Thermal Protection	23
4.16	CoolMOS™ Section	24
5	CoolMOS™ Performance Characteristics	25
6	Output Power Curve	32
7	Outline Dimension.....	36
8	Marking.....	37
	Revision history.....	38

Pin Configuration and Functionality

1 Pin Configuration and Functionality

The pin configuration is shown in Figure 2 and the functions are described in Table 2.

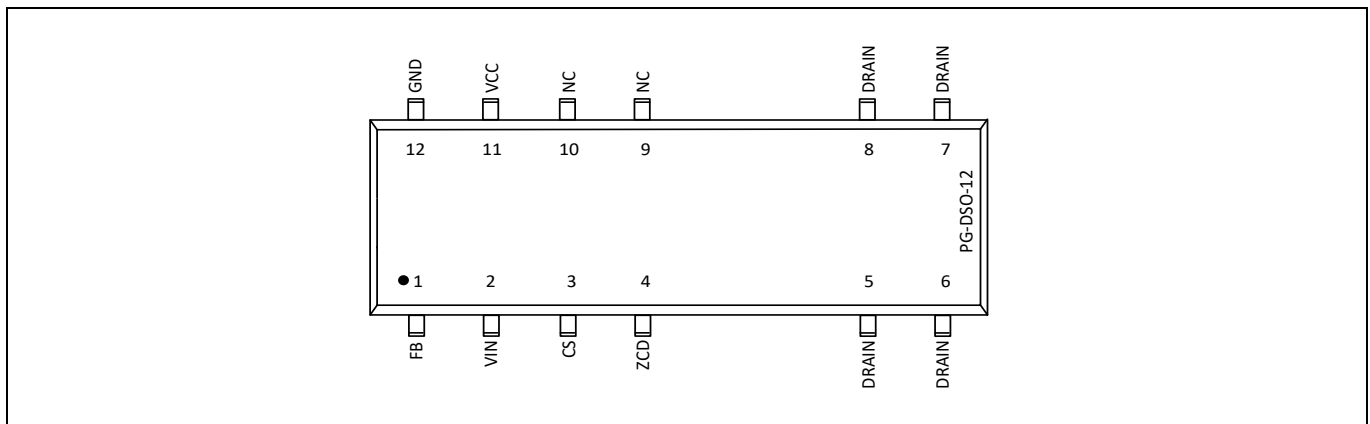

Figure 2 Pin Configuration

Table 2 Pin Definitions and Functions

Pin	Symbol	Function
1	FB	Feedback & Burst entry/exit control FB pin combines the functions of feedback control, selectable burst entry/exit control and overload/open loop protection.
2	VIN	Input Line OVP & Brownout VIN pin is connected to the bus via resistor divider (see Figure 1) to sense the line voltage. This pin combines the functions of input Line OVP, Brownout and minimum ZC count setting for low and high line.
3	CS	Current Sense The CS pin is connected to the shunt resistor for the primary current sensing externally and to the PWM signal generator block for switch-off determination (together with the feedback voltage) internally.
4	ZCD	Zero Crossing Detection ZCD pin combines the functions of start up, zero crossing detection and output over voltage protection. During the start up, it is used to provide a voltage level to the gate of power switch CoolMOS™ to charge V_{CC} capacitor.
5, 6, 7, 8	DRAIN	Drain The DRAIN pin is connected to the drain of the integrated CoolMOS™.
11	VCC	VCC(Positive Voltage Supply) The VCC pin is the positive voltage supply to the IC. The operating range is between V_{VCC_OFF} and V_{VCC_OVP} .
12	GND	Ground The GND pin is the common ground of the CoolSET™.
9, 10	NC	Not connected.

Representative Block Diagram

2 Representative Block Diagram

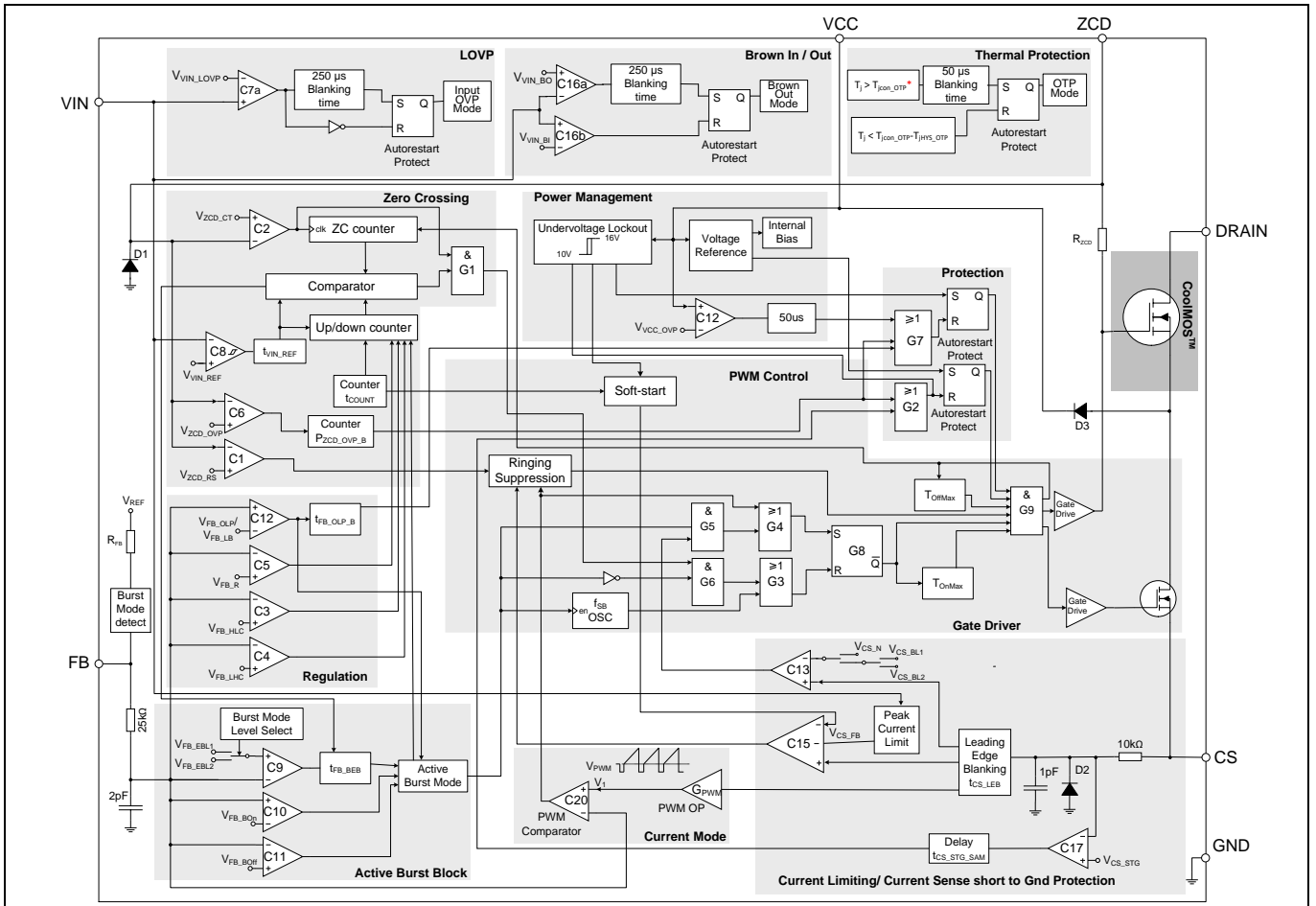

Figure 3 Representative Block Diagram

Note: Junction temperature of the controller chip is sensed for over temperature protection. The CoolMOS™ is a separated chip from the controller chip in the same package. Please refer to the design guide and/or consult a technical expert from Infineon for the proper thermal design.

Functional Description

3 Functional Description

3.1 V_{CC} Pre-Charging and Typical V_{CC} Voltage during Start-up

As shown in Figure 1, once the line input voltage is applied, a rectified voltage appears across the capacitor C_{BUS}. The pull up resistor R_{STARTUP} provides a current to charge the C_{iss} (input capacitance) of CoolMOS™ and gradually generate one voltage level. If the voltage over C_{iss} is high enough, CoolMOS™ on and V_{CC} capacitor will be charged through primary inductance of transformer L_P, CoolMOS™ and internal diode D₃ with two steps constant current source I_{VCC_Charge1}¹ and I_{VCC_Charge3}¹.

A very small constant current source (I_{VCC_Charge1}) is charged to the V_{CC} capacitor till V_{CC} reach V_{CC_SCP} to protect the controller from V_{CC} pin short to ground during the start up. After this, the second step constant current source (I_{VCC_Charge3}) is provided to charge the V_{CC} capacitor further, until the V_{CC} voltage exceeds the turned-on threshold V_{VCC_ON}. As shown in the time phase I in Figure 4, the V_{CC} voltage increase almost linearly with two steps.

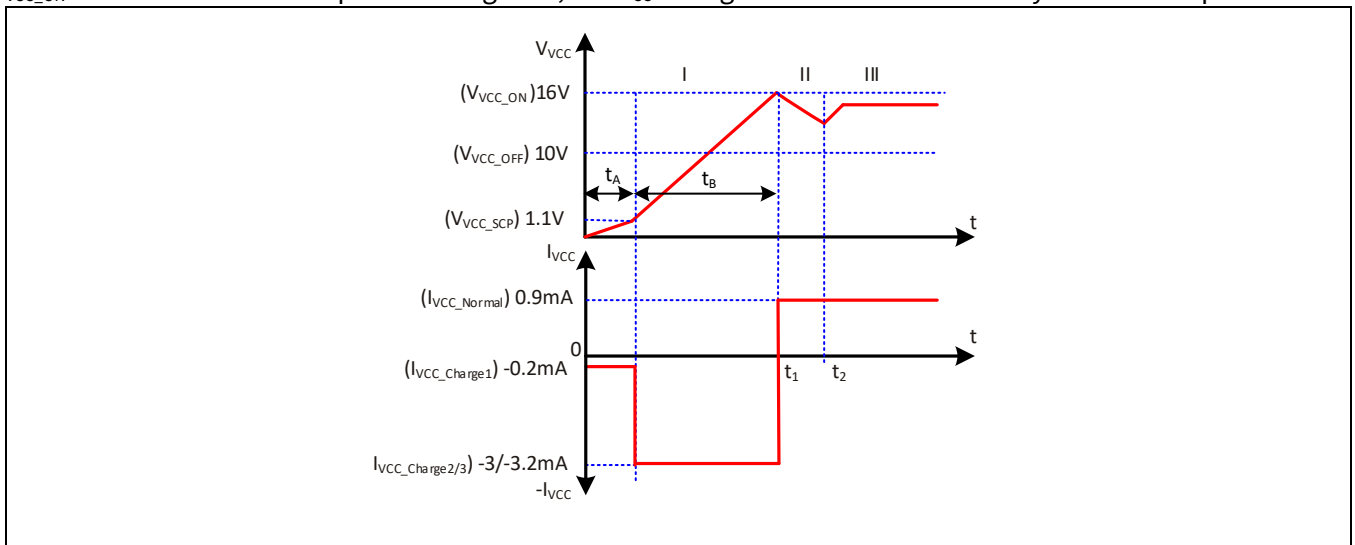

Figure 4 V_{CC} voltage and current at start up

The time taking for the V_{CC} pre-charging can then be approximately calculated as:

$$t_1 = t_A + t_B = \frac{V_{VCC_SCP} \cdot C_{VCC}}{I_{VCC_Charge1}} + \frac{(V_{VCC_ON} - V_{VCC_SCP}) \cdot C_{VCC}}{I_{VCC_Charge3}} \tag{1}$$

When the V_{CC} voltage exceeds the V_{CC} turned on threshold V_{VCC_ON} at time t₁, the IC begins to operate with soft start. Due to power consumption of the IC and the fact that there is still no energy from the auxiliary winding to charge the V_{CC} capacitor before the output voltage is built up, the V_{CC} voltage drops (Phase II). Once the output voltage is high enough, the V_{CC} capacitor receives the energy from the auxiliary winding from the time t₂ onward and delivering the I_{VCC_Normal}² to the CoolSET™. The V_{CC} then will reach a constant value depending on output load.

3.2 Soft-start

As shown in Figure 5, at the time t_{on}, the IC begins to operate with a soft-start. By this soft-start the switching stresses for the MOSFET, diode and transformer are minimized. The soft-start implemented in ICE5QRxx80BG is a digital time-based function. The preset soft-start time is t_{SS} (12 ms) with 4 steps. If not limited by other functions, the peak voltage on CS pin will increase step by step from 0.3 V to 1 V finally. During the first 3 ms of soft start, the ringing suppression time is set to 25 μs to avoid irregular switching due to switch off oscillation noise.

¹ I_{VCC_Charge1/2/3} is charging current from the controller to V_{CC} capacitor during start up

² I_{VCC_Normal} is supply current from V_{CC} capacitor or auxiliary winding to the CoolSET™ during normal operation

Functional Description

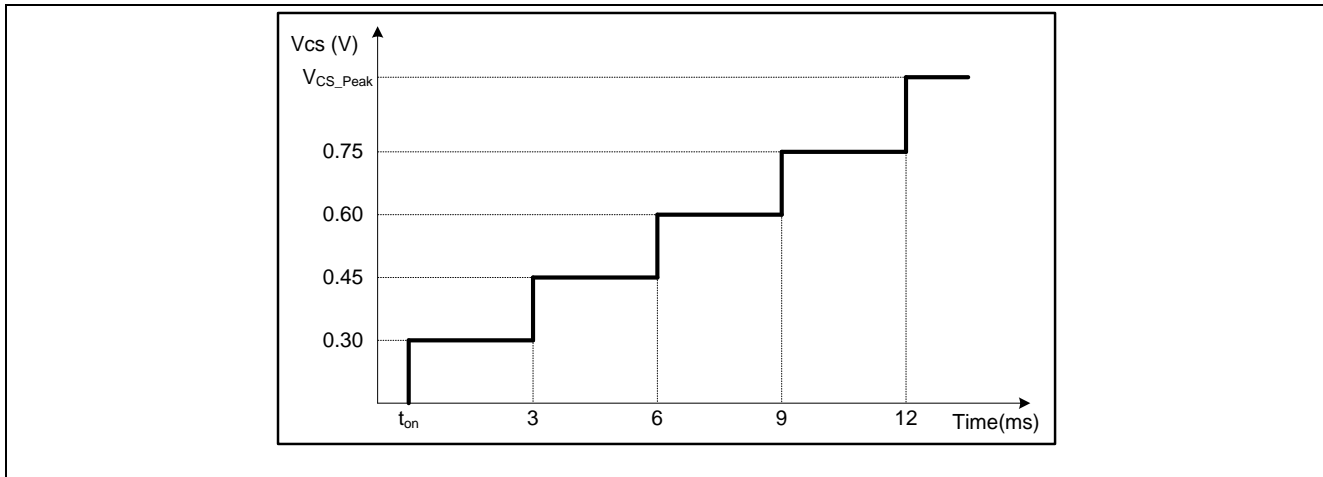

Figure 5 Maximum current sense voltage during soft start

3.3 Normal Operation

During normal operation, the ICE5QRxx80BG works with a digital signal processing circuit composing an up/down counter, a zero-crossing counter (ZC counter) and a comparator, and an analog circuit composing a current measurement unit and a comparator. The switch-on and -off time points are each determined by the digital circuit and the analog circuit, respectively. The input information of the zero-crossing signal and the value of the up/down counter are needed to determine the switch-on while the feedback signal V_{FB} and the current sensing signal V_{CS} are necessary for the switch-off determination. Details about the full operation of the CoolSET™ in normal operation are illustrated in the following paragraphs.

3.3.1 Digital Frequency Reduction

As mentioned above, the digital signal processing circuit consists of an up/down counter, a ZC counter and a comparator. These three parts are key to implement digital frequency reduction with decreasing load. In addition, a ringing suppression time controller is implemented to avoid mis-triggering by the high frequency oscillation when the output voltage is very low under conditions such as soft start period or output short circuit. Functionality of these parts is described as in the following.

3.3.1.1 Minimum ZC Count Determination

To reduce the switching frequency difference between low and high line, minimum ZC count determination is implemented. Minimum ZC count is set to 1 if V_{IN} less than V_{VIN_REF} which represents for low line. For high line, minimum ZC count is set to 3 after V_{IN} higher than V_{VIN_REF} . There is also a hysteresis V_{VIN_REF} with certain blanking time t_{VIN_REF} for stable AC line selection between low and high line.

3.3.1.2 Up/down counter

The up/down counter stores the number of the zero crossing which determines valley numbers to switch-on the main MOSFET after demagnetization of the transformer. This value is fixed according to the feedback voltage, V_{FB} , which contains information about the output power. Indeed, in a typical peak current mode control, a high output power results in a high feedback voltage, and a low output power leads to a low feedback voltage. Hence, according to V_{FB} , the value in the up/down counter is changed to vary the power MOSFET off-time according to the output power. In the following, the variation of the up/down counter value according to the feedback voltage is explained.

Functional Description

The feedback voltage V_{FB} is internally compared with three threshold voltages V_{FB_LHC} , V_{FB_HLC} and V_{FB_R} at each clock period of 48 ms. The up/down counter counts then upward, keep unchanged or count downward, as shown in Table 3.

Table 3 Operation of up/down counter

V_{FB}	up/down counter action
Always lower than V_{FB_LHC}	Count upwards till $n=8/10^1$
Once higher than V_{FB_LHC} , but always lower than V_{FB_HLC}	Stop counting, no value changing
Once higher than V_{FB_HLC} , but always lower than V_{FB_R}	Count downwards till $n=1/3^2$
Once higher than V_{FB_R}	Set up/down counter to $n=1/3^2$

The number of zero crossing is limited and therefore, the counter varies among 1 to 8 (for low line) or 3 to 10 (for high line) and any attempt beyond this range is ignored. When V_{FB} exceeds V_{FB_R} voltage, the up/down counter is reset to 1 (low line) and 3 (high line) in order to allow the system to react rapidly to a sudden load increase. The up/down counter value is also reset to 1 (low line) and 3 (high line) at the start-up time, to ensure an efficient maximum load start up. Figure 6 shows some examples on how up/down counter is changed according to the feedback voltage over time.

The use of two different thresholds V_{FB_LHC} and V_{FB_HLC} to count upward or downward is to prevent frequency jittering when the feedback voltage is close to the threshold point.

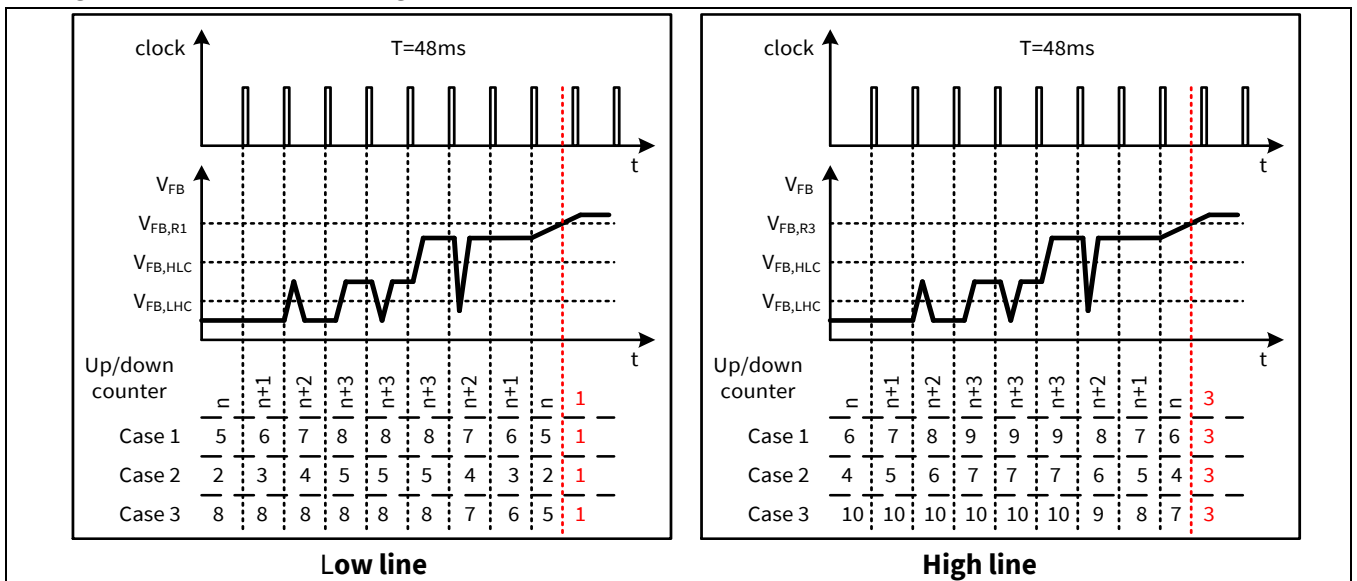

Figure 6 Up/down counter operation

3.3.1.3 Zero crossing (ZC counter)

In the system, the voltage from the auxiliary winding is applied to the ZCD pin through a RC network, which provides a time delay to the voltage from the auxiliary winding. Internally this pin is connected to a negative clamping network, a zero-crossing detector, an output overvoltage detector and a ringing suppression time controller.

During on-state of the power switch, a positive gate drive voltage is applied to the ZCD pin due to R_{ZCD} resistor, hence external diode D_{ZC} (see Figure 1) is added to block the negative voltage from the auxiliary winding.

The ZC counter has a minimum value of 1 (for low line) or 3 (for high line) and maximum value of 8 (for low line) or 10 (for high line). After the internal high voltage CoolMOST™ is turned off, every time when the falling voltage

¹ $n=8$ (for low line) and $n=10$ (for high line)

² $n=1$ (for low line) and $n=3$ (for high line)

Functional Description

ramp of on ZCD pin crosses the V_{ZCD_CT} threshold, a zero crossing is detected and ZC counter will increase by 1. It is reset every time after the DRIVER output is changed to high.

To achieve the switch on at voltage valley, the voltage from the auxiliary winding is fed to a time delay network (the RC network consists of R_{ZC} and C_{ZC} as shown in Figure 1) before it is applied to the zero-crossing detector through the ZCD pin. The needed time delay to the main oscillation signal Δt should be approximately one fourth of the oscillation period, T_{OSC} (by transformer primary inductor and drain-source capacitor) minus the propagation delay from the detected zero-crossing to the switch-on of the main switch t_{delay} , theoretically:

$$\Delta t = \frac{T_{OSC}}{4} - t_{delay} \tag{2}$$

This time delay should be matched by adjusting the time constant of the RC network which is calculated as:

$$\tau_{td} = C_{ZC} \cdot \frac{R_{ZC} \cdot R_{ZCD}}{R_{ZC} + R_{ZCD}} \tag{3}$$

3.3.2 Ringing suppression time

After CoolMOS™ is turned off, there will be some oscillation on V_{DS} , which will also appear on V_{ZCD} . To avoid mis-triggering by such oscillations to turn on the CoolMOS™, a ringing suppression timer is implemented. This suppression time is depended on the voltage V_{ZCD} . If the voltage V_{ZCD} is lower than the threshold V_{ZCD_RS} , a longer preset time t_{ZCD_RS2} is applied. However, if the voltage V_{ZCD} is higher than the threshold, a shorter time t_{ZCD_RS1} is set.

3.3.2.1 Switch on determination

After the gate drive goes to low, it cannot be changed to high during ring suppression time.

After ring suppression time, the gate drive can be turned on when the ZC counter value is equal to up/down counter value.

However, it is also possible that the oscillation between primary inductor and drain-source capacitor damps very fast and IC cannot detect zero crossings event. In this case, a maximum off time is implemented. After gate drive has been remained off for the period of T_{OffMax} , the gate drive will be turned on again regardless of the ZC counter values and V_{ZCD} . This function can effectively prevent the switching frequency from going lower than 20 kHz. Otherwise it will cause audible noise.

3.3.3 Switch off determination

In the converter system, the primary current is sensed by an external shunt resistor, which is connected between the internal low side MOSFET and the common ground. The sensed voltage across the shunt resistor V_{CS} is applied to an internal current measurement unit, and its output voltage V_1 is compared with the feedback voltage V_{FB} . Once the voltage V_1 exceeds the voltage V_{FB} , the output flip-flop is reset. As a result, the main power switch is switched off. The relationship between the V_1 and the V_{CS} is described by (see Figure 3):

$$\begin{aligned} V_{CS} &= I_D \times R_{CS} \\ V_1 &= G_{PWM} \cdot V_{CS} + V_{PWM} \end{aligned} \tag{4}$$

where, V_{CS} : CS pin voltage

I_D : power MOSFET current

R_{CS} : resistance of the current sense resistor

V_1 : voltage level compared to V_{FB}

G_{PWM} : PWM-OP gain

Functional Description

To avoid mis-triggering caused by the voltage spike across the shunt resistor at the turn on of the main power switch, a leading edge blanking time, t_{LEB} , is applied to the output of the comparator. In other words, once the gate drive is turned on, the minimum on time of the gate drive is the leading edge blanking time.

In addition, there is a maximum on time, t_{ONMAX} , limitation implemented in the IC. Once the gate drive has been in high state longer than the maximum on time, it will be turned off to prevent the switching frequency from going too low because of long on time.

Also, if the voltage at the current sense pin is lower than the preset threshold V_{CS_STG} after the time $t_{CS_STG_SAM}$ for three consecutive pulses during on-time of the power switch, this abnormal V_{CS} will trigger IC into auto restart mode.

3.3.4 Modulated gate drive

The drive-stage is optimized for EMI consideration. The switch on speed is slowed down before it reaches the CoolMOS™ turn on threshold. That is a slope control of the rising edge at the output of driver (see Figure 7). Thus the leading switch spike during turn on is minimized.

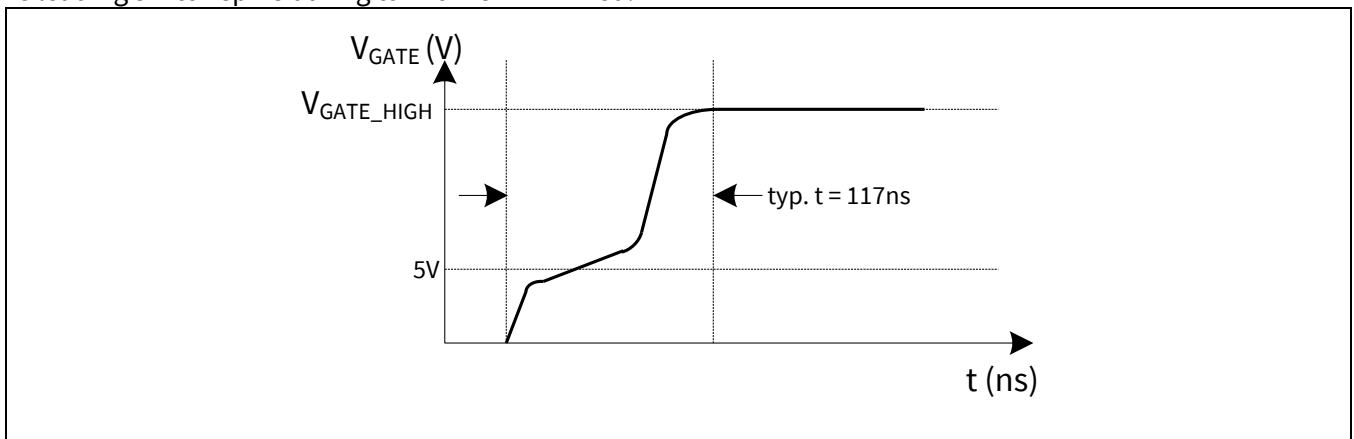

Figure 7 Gate rising waveform

3.4 Current limitation

There is a cycle by cycle current limitation realized by the current limit comparator to provide over-current detection. The source current of the CoolMOS™ is sensed via a sense resistor R_{CS} . By means of R_{CS} the source current is transformed to a sense voltage V_{CS} which is fed into the pin CS. If the voltage V_{CS} exceeds an internal voltage limit, adjusted according to the Line voltage, the comparator immediately turns off the gate drive.

When the main bus voltage increases, the switch on time becomes shorter and therefore the operating frequency is also increased. As a result, for a constant primary current limit, the maximum possible output power is increased which is beyond the converter design limit.

To compensate such effect, both the internal peak current limit circuit (V_{CS}) and the ZC count varies with the bus voltage according to Figure.

Functional Description

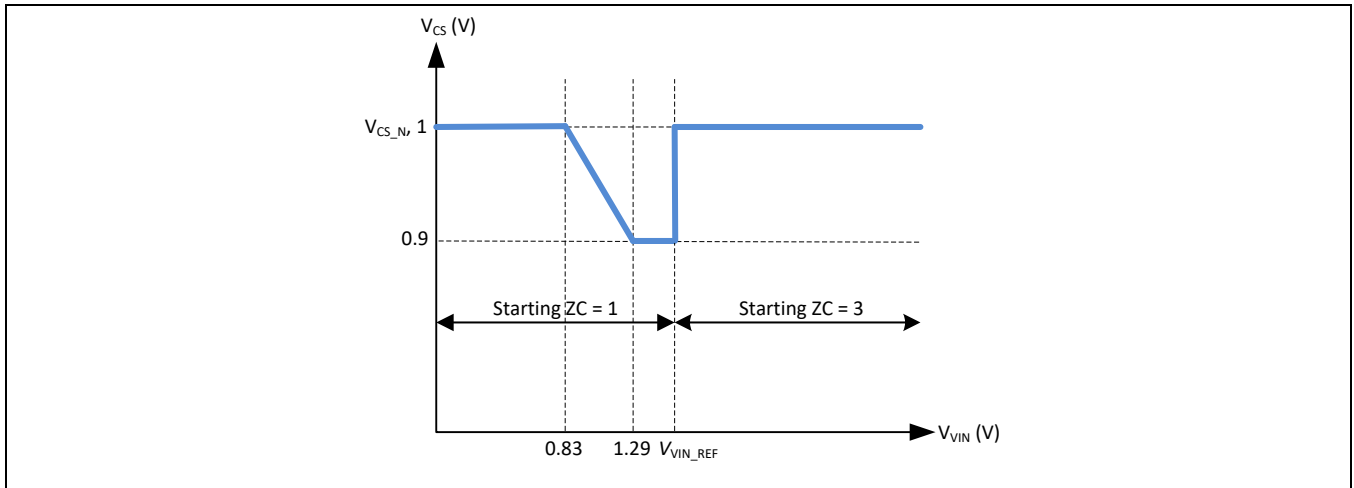

Figure 8 Variation of the V_{CS} limit voltage according to the V_{IN} voltage

3.5 Active Burst Mode with selectable power level

At light load condition, the IC enters Active Burst Mode operation to minimize the power consumption. Details about Active Burst Mode operation are explained in the following paragraphs.

The burst mode entry level can be selected by changing the different resistor R_{sel} at FB pin. There are 2 levels to be selected with different resistor which are targeted for low range of Active Burst Mode power (Level 1) and high range of Active Burst Mode power (Level 2). The following table shows the control logic for the entry and exit level with the FB voltage.

Table 4 Two levels entry and exit Active Burst Mode power

Level	V_{FB}	V_{CS}	Entry level	Exit level
			V_{FB_EBLX}	V_{FB_LB}
1	$V_{FB} > V_{REF_B}$	$V_{CS_BL1} = 0.31\text{ V}$	0.90 V	2.75 V
2	$V_{FB} < V_{REF_B}$	$V_{CS_BL2} = 0.35\text{ V}$	1.05 V	2.75 V

During IC first startup, the internal Ref_{GOOD} signal is logic low when $V_{CC} < 4\text{ V}$. It will reset the Burst Mode level Detection latch. When the Burst Mode Level Detection latch is low and IC is in OFF state, the IC internal R_{FB} resistor is disconnected from the FB pin and a current source I_{sel} is turned on instead.

From $V_{CC}=4\text{ V}$ to V_{CC} on threshold, the FB pin will start to charge to a voltage level associated with R_{sel} resistor. When V_{CC} reaches V_{CC} on threshold, the FB voltage is sensed. The burst mode thresholds are then chosen according to the FB voltage level. The Burst Mode Level Detection latch is then set to high. Once the detection latch is set high, any change of the FB level will not change the threshold selection. The current source I_{sel} is turned off in $2\ \mu\text{s}$ after V_{CC} reaches V_{CC} on threshold and the R_{FB} resistor is re-connected to FB pin (see Figure 9).

Functional Description

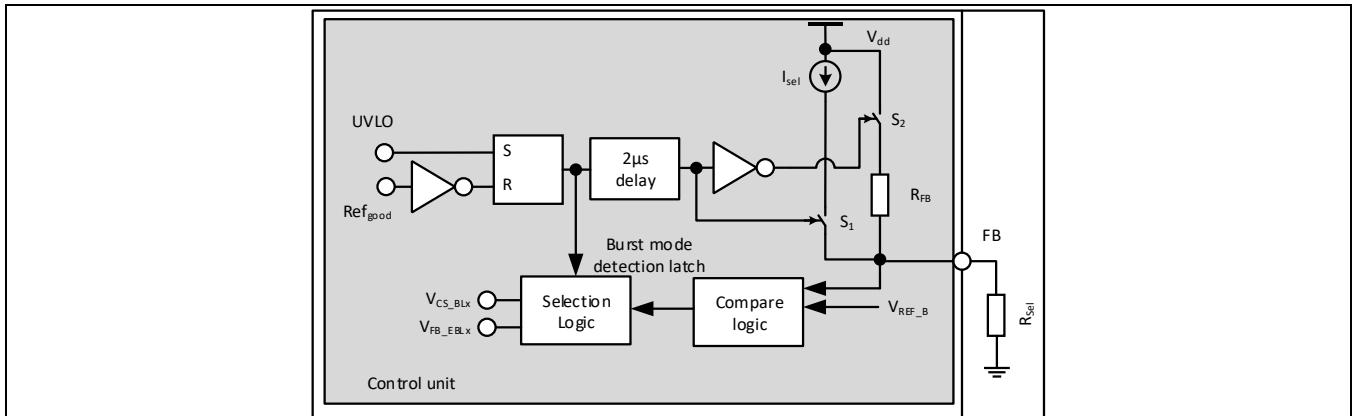

Figure 9 Burst mode detect and adjust

3.5.1 Entering Active Burst Mode Operation

For determination of entering Active Burst Mode operation, three conditions apply:

- the feedback voltage is lower than the threshold of V_{FB_EBLX}
- the up/down counter is 8 for low line or 10 for high line and
- the above two conditions remain after a certain blanking time t_{FB_BEB} (20 ms)

Once all of these conditions are fulfilled, the Active Burst Mode flip-flop is set and the controller enters Active Burst Mode operation. This multi-condition determination for entering Active Burst Mode operation prevents mis-triggering of entering Active Burst Mode operation, so that the controller enters Active Burst Mode operation only when the output power is really low during the preset blanking time.

3.5.2 During Active Burst Mode Operation

After entering the Active Burst Mode the feedback voltage rises as V_o starts to decrease due to the inactive PWM section. One comparator observes the feedback signal if the voltage level V_{FB_BOn} is exceeded. In that case the internal circuit is power up to restart with switching.

Turn-on of the power MOSFET is triggered by ZC counter with a fixed value of 8 ZC for low line and 10 ZC for high line. Turn-off is resulted if the voltage across the shunt resistor at CS pin hits the threshold V_{CS_BLX} .

If the output load is still low, the feedback signal decreases as the PWM section is operating. When feedback signal reaches the low threshold V_{FB_BOff} , the internal circuit is reset again and the PWM section is disabled until next time V_{FB} signal increases beyond the V_{FB_BOn} threshold. In Active Burst Mode, the feedback signal is changing like a saw tooth between V_{FB_BOff} and V_{FB_BOn} (see Figure 10).

3.5.3 Leaving Active Burst Mode Operation

The feedback voltage immediately increases if there is a high load jump. This is observed by a comparator with threshold of V_{FB_LB} . As the current limit is V_{CS_BLX} (31% or 35%) during Active Burst Mode, a certain load is needed so that feedback voltage can exceed V_{FB_LB} . After leaving Active Burst Mode, Gate will only turn on if zero crossing is detected ($V_{ZCD} < V_{ZCD_LB}$) to ensure full transformer demagnetization. This eases synchronous rectification implementation by ensuring DCM operation upon exit of burst mode. Then, normal peak current control through V_{FB} is re-activated. In addition, the up/down counter will be set to 1 (low line) or 3 (high line) immediately after leaving Active Burst Mode. This is helpful to minimize the output voltage undershoot.

Functional Description

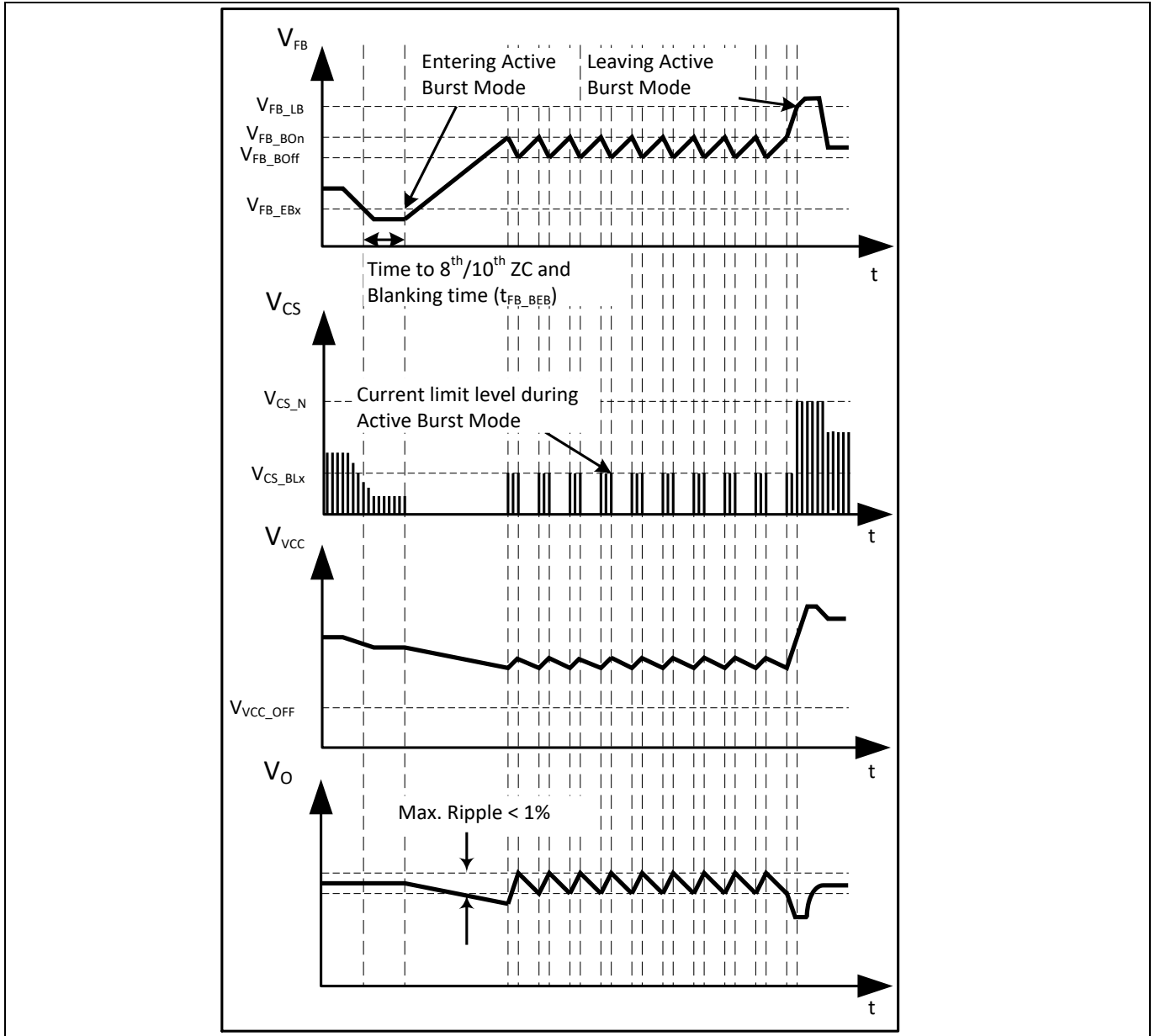

Figure 10 Signals in Active Burst Mode

3.6 Protection Functions

The ICE5QRxx80BG provides numerous protection functions which considerably improve the power supply system robustness, safety and reliability. The following table summarizes these protection functions. There are 3 different kinds of protection mode; non switch auto restart, auto restart and odd skip auto restart. The details can refer to the Figure 11, Figure 12 and Figure 13.

Table 5 Protection functions

Protection Functions	Normal Mode	Burst Mode		Protection Mode
		Burst ON	Burst OFF	
Line Over Voltage	√	√	√	Non switch Auto Restart
Brownout	√	√	√	Non switch Auto Restart

Functional Description

Protection Functions	Normal Mode	Burst Mode		Protection Mode
		Burst ON	Burst OFF	
V _{CC} Over Voltage	✓	✓	NA ¹	Odd skip Auto Restart
V _{CC} Under Voltage	✓	✓	✓	Auto Restart
Over Load	✓	NA ¹	NA ¹	Odd skip Auto Restart
Output Over Voltage	✓	✓	NA ¹	Odd skip Auto Restart
Over Temperature	✓	✓	✓	Non switch Auto Restart

3.6.1 Line Over Voltage

The AC **Line Over Voltage** Protection is detected by sensing bus capacitor voltage through VIN pin via 2 potential divider resistors, R₁₁ and R₁₂ (see Figure 1). Once V_{VIN} voltage is higher than the line over voltage threshold V_{VIN_LOVP}, the controller enters Line Over Voltage Protection and it releases the protection mode after V_{VIN} is lower than V_{VIN_LOVP}.

3.6.2 Brownout

The **Brownout** protection is observed by VIN pin similar to line over voltage Protection method with a different voltage threshold level. When V_{VIN} voltage is lower than the brownout threshold (V_{VIN_BO}), the controller enters Brownout Protection and it releases the protection mode after V_{VIN} higher than brownin threshold (V_{VIN_BI}).

3.6.3 V_{CC} Over Voltage or Under Voltage

During operation, the V_{CC} voltage is continuously monitored. In case of a **V_{CC} Over Voltage** or **Under Voltage**, the IC is reset and the main power switch is then kept off. After the V_{CC} voltage falls below the threshold V_{VCC_OFF}, the new start up sequence is activated. The V_{CC} capacitor is then charged up. Once the voltage exceeds the threshold V_{VCC_ON}, the IC begins to operate with a new soft-start.

3.6.4 Over Load

In case of open control loop or output **Over Load**, the feedback voltage will be pulled up and exceed V_{FB_OLP}. After a blanking time of t_{FB_OLP_B}, the IC enters auto restart mode. The blanking time here enables the converter to operate for a certain time during a sudden load jump.

3.6.5 Output Over Voltage

During off-time of the power MOSFET, the voltage at the ZCD pin is monitored for **Output Over Voltage** detection. If the voltage is higher than the preset threshold V_{ZCD_OVP} for 10 consecutive pulses, the IC enters Output Over Voltage Protection.

3.6.6 Over Temperature

If the junction temperature of controller chip exceeds T_{JCON_OTP}, the IC enters into **Over Temperature** protection (OTP) auto restart mode. The controller implements with a 40 °C hysteresis. In another word, the controller/IC can only resume from OTP if its junction temperature drops 40 °C from OTP trigger point. Please be noted that the separated CoolMOS™ chip may have different temperature (mostly higher) from the controller chip.

¹ Not Applicable

Functional Description

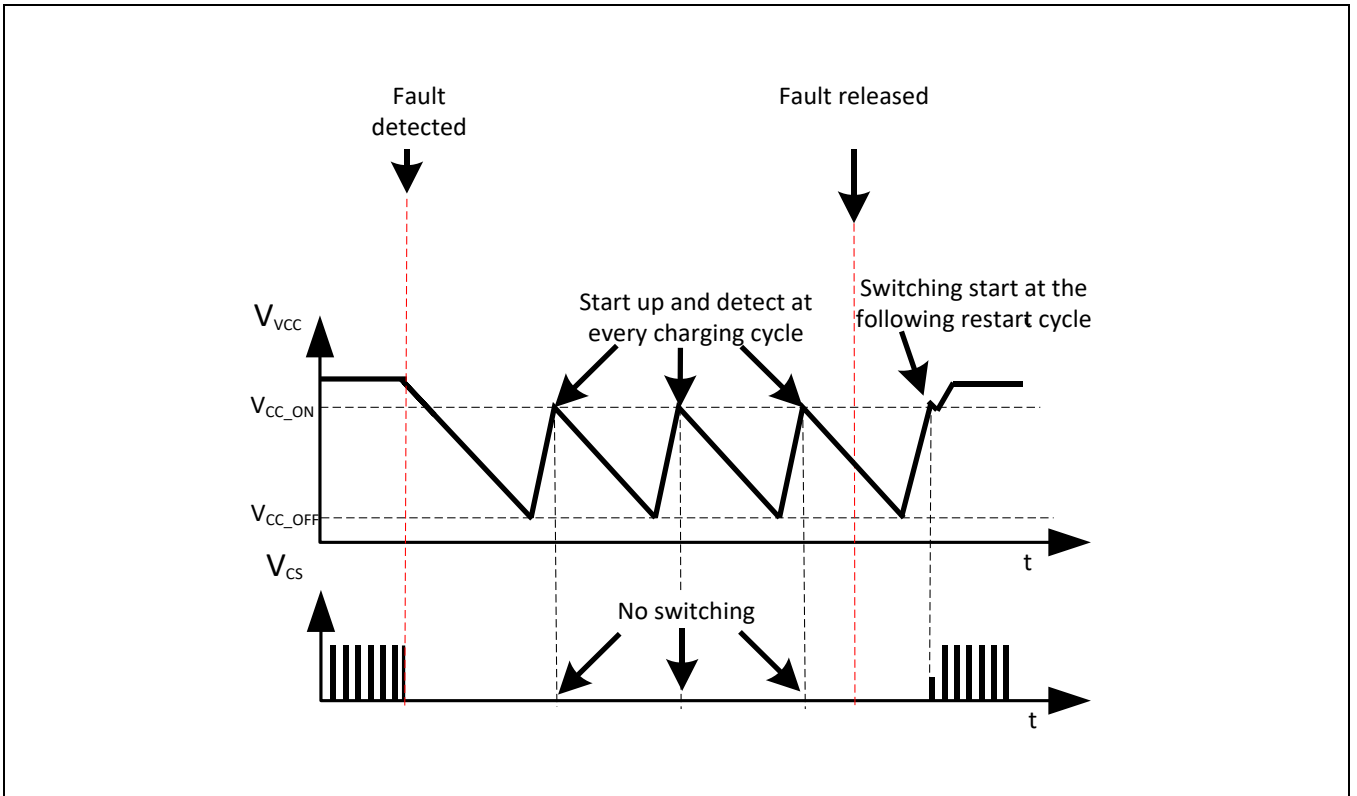

Figure 11 Non switch Auto Restart Mode

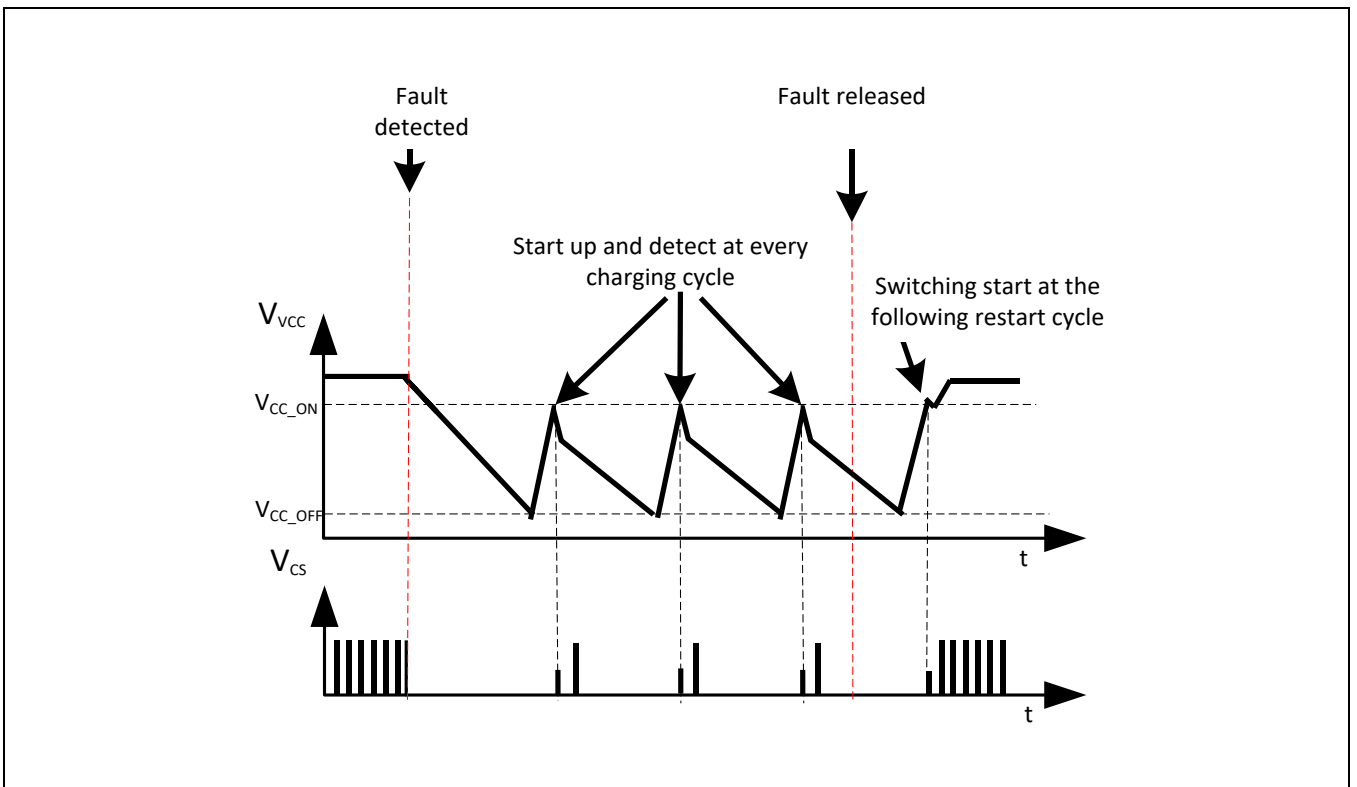

Figure 12 Auto Restart Mode

Functional Description

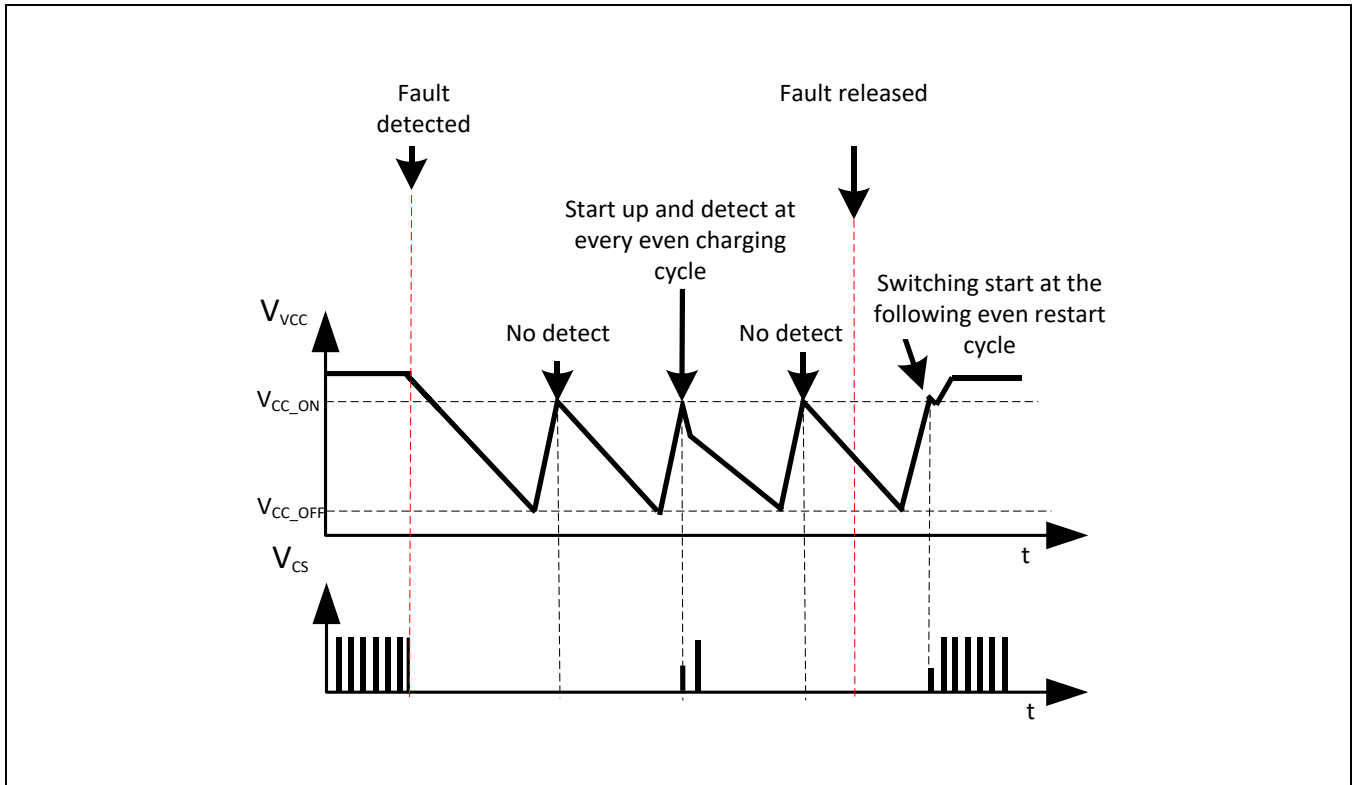

Figure 13 Odd skip Auto Restart Mode

Electrical Characteristics

4 Electrical Characteristics

Attention: All voltages are measured with respect to ground (Pin12). The voltage levels are valid if other ratings are not violated.

4.1 Absolute Maximum Ratings

Attention: Stresses above the maximum values listed here may cause permanent damage to the device. Exposure to absolute maximum rating conditions for extended periods may affect device reliability. Maximum ratings are absolute ratings; exceeding only one of these values may cause irreversible damage to the integrated circuit. System design needs to ensure not to exceed the maximum limit. $T_a=25^{\circ}\text{C}$ unless otherwise specified.

Table 6 Absolute Maximum Ratings

Parameter	Symbol	Limit Values		Unit	Note / Test Condition
		Min.	Max.		
Drain Source Voltage (CoolMOS™) ICE5QRxx80BG	V_{DS}	-	800	V	$T_j = 25^{\circ}\text{C}$
Pulse drain current ICE5QR4780BG ¹ ICE5QR2280BG ² ICE5QR1680BG ² ICE5QR0680BG ²	I_{D_Pulse}	- - - -	2.6 5.8 5.8 5.8	A	
Avalanche energy, repetitive, t_{AR} limited by max. $T_j=150^{\circ}\text{C}$ with $T_{j,Start}=25^{\circ}\text{C}$ ICE5QR4780BG ICE5QR2280BG ICE5QR1680BG ICE5QR0680BG	E_{AR}	- - - -	0.02 0.05 0.07 0.22	mJ	$I_D=0.2\text{ A}, V_{DD}=50\text{ V}$ $I_D=0.4\text{ A}, V_{DD}=50\text{ V}$ $I_D=0.6\text{ A}, V_{DD}=50\text{ V}$ $I_D=1.8\text{ A}, V_{DD}=50\text{ V}$
Avalanche current, repetitive, t_{AR} limited by max. $T_j=150^{\circ}\text{C}$ with $T_{j,Start}=25^{\circ}\text{C}$ ICE5QR4780BG ICE5QR2280BG ICE5QR1680BG ICE5QR0680BG	I_{AR}	- - - -	0.2 0.4 0.6 1.8	A	
VCC Supply Voltage	V_{CC}	-0.3	27.0	V	
FB Voltage	V_{FB}	-0.3	3.6	V	
ZCD Voltage	V_{ZCD}	-0.3	27	V	
CS Voltage	V_{CS}	-0.3	3.6	V	

¹ Pulse width t_P limited by $T_{j,Max}$

² Pulse width $t_P=20\ \mu\text{s}$ and limited by $T_{j,Max}$

Electrical Characteristics

VIN Voltage	V _{IN}	-0.3	3.6	V	
Maximum DC current on any pin except DRAIN & CS pins		-10.0	10.0	mA	
ESD robustness HBM	V _{ESD_HBM}	-	2000	V	According to EIA/JESD22
ESD robustness CDM	V _{ESD_CDM}	-	500	V	
Junction temperature range	T _J	-40	150	°C	Controller & CoolMOS
Storage Temperature	T _{STORE}	-55	150	°C	
Thermal Resistance (Junction-Ambient)	R _{thJA}			K/W	Setup according to the JESD51 standard and using minimum drain pin copper area in a 2 oz copper single sided PCB
ICE5QR4780BG		-	105		
ICE5QR2280BG		-	98		
ICE5QR1680BG		-	95		
ICE5QR0680BG		-	94		

4.2 Operating Range

Note: Within the operating range the IC operates as described in the functional description.

Table 7 Operating Range

Parameter	Symbol	Limit Values		Unit	Remark
		Min.	Max.		
VCC Supply Voltage	V _{VCC}	V _{VCC_OFF}	V _{VCC_OVP}		
Junction Temperature of controller	T _{JCon_op}	-40	T _{JCon_OTP}	°C	Max value limited due to OTP of controller chip
Junction Temperature of CoolMOS	T _{JCoolMOS_op}	-40	150	°C	

4.3 Operating Conditions

Note: The electrical characteristics involve the spread of values within the specified supply voltage and junction temperature range T_J from - 40 °C to 125 °C. Typical values represent the median values, which are related to 25°C. If not otherwise stated, a supply voltage of V_{CC} = 18 V is assumed.

Table 8 Operating Conditions

Parameter	Symbol	Limit Values			Unit	Note / Test Condition
		Min.	Typ.	Max.		
VCC Charge Current	I _{VCC_Charge1}	-0.35	-0.2	-0.09	mA	V _{VCC} =0V, R _{StartUp} =50MΩ and V _{DRAIN} =90V
	I _{VCC_Charge2}	-	-3.2	-	mA	V _{VCC} =3V, R _{StartUp} =50MΩ and V _{DRAIN} =90V
	I _{VCC_Charge3}	-5	-3	-1	mA	V _{VCC} =15V, R _{StartUp} =50MΩ and V _{DRAIN} =90V
Current Consumption, Startup Current	I _{VCC_Startup}	-	0.19	-	mA	V _{VCC} =15V

Electrical Characteristics

Current Consumption, Normal	I_{VCC_Normal}	-	0.9	-	mA	$I_{FB}=0A$ (No gate switching)
Current Consumption, Auto Restart	I_{VCC_AR}	-	320	-	μA	
Current Consumption, Burst Mode	$I_{VCC_Burst\ Mode}$	-	0.5	-	mA	$V_{FB}=1.8V$
VCC Turn-on Threshold Voltage	V_{VCC_ON}	15.3	16	16.5	V	
VCC Turn-off Threshold Voltage	V_{VCC_OFF}	9.5	10	10.5	V	
VCC Short Circuit Protection	V_{VCC_SCP}	-	1.1	1.9	V	
VCC Turn-off blanking	$t_{VCC_OFF_B}$	-	50	-	μs	

4.4 Internal Voltage Reference

Table 9 Internal Voltage Reference

Parameter	Symbol	Limit Values			Unit	Note / Test Condition
		Min.	Typ.	Max.		
Internal Reference Voltage	V_{REF}	3.2	3.3	3.39	V	Measured at pin FB $I_{FB}=0$

4.5 PWM Section

Table 10 PWM Section

Parameter	Symbol	Limit Values			Unit	Note / Test Condition
		Min.	Typ.	Max.		
Feedback Pull-Up Resistor	R_{FB}	11	15	20	k Ω	
PWM-OP Gain	G_{PWM}	1.95	2.05	2.15	-	
Offset for Voltage Ramp	V_{PWM}	0.42	0.5	0.58	V	
Maximum on time in normal operation	t_{OnMax}	20	35	60	μs	
Maximum off time in normal operation	t_{OffMax}	24	42.5	71	μs	

4.6 Current Sense

Table 11 Current Sense

Parameter	Symbol	Limit Values			Unit	Note / Test Condition
		Min.	Typ.	Max.		
Peak current limitation in normal operation	V_{CS_N}	0.94	1.00	1.06	V	
Leading Edge Blanking time	t_{CS_LEB}	118	220	462	ns	
Peak Current Limitation in Active Burst Mode – Level 1	V_{CS_BL1}	0.26	0.31	0.36	V	
Peak Current Limitation in Active Burst Mode – Level 2	V_{CS_BL2}	0.3	0.35	0.4	V	
Abnormal CS voltage threshold	V_{CS_STG}	0.06	0.10	0.15	V	

Electrical Characteristics

Abnormal CS voltage Consecutive Trigger	P_{CS_STG}	-	3	-	cycle	
Abnormal CS voltage Sample period	$t_{CS_STG_SAM}$	2.3	5	-	μs	

4.7 Soft Start

Table 12 Soft Start

Parameter	Symbol	Limit Values			Unit	Note / Test Condition
		Min.	Typ.	Max.		
Soft-Start time	t_{SS}	8.5	12	-	ms	
Soft-start time step	$t_{SS_S}^1$	-	3	-	ms	
Internal regulation voltage at first step	V_{SS1}^1	-	0.30	-	V	CS peak voltage
Internal regulation voltage step at soft start	$V_{SS_S}^1$	-	0.15	-	V	CS peak voltage

4.8 Digital Zero Crossing

Table 13 Digital Zero Crossing

Parameter	Symbol	Limit Values			Unit	Note / Test Condition
		Min.	Typ.	Max.		
Zero crossing threshold voltage	V_{ZCD_CT}	60	100	150	mV	
Zero crossing Ringing suppression threshold	V_{ZCD_RS}	-	0.45	-	V	
Minimum ringing suppression time	t_{ZCD_RS1}	1.5	2.5	4.1	μs	$V_{ZCD} > V_{ZCD,RS}$
Maximum ringing suppression time	t_{ZCD_RS2}	-	25.00	-	μs	$V_{ZCD} < V_{ZCD,RS}$
Threshold to reset Up/Down Counter	V_{FB_R}	-	2.80	-	V	
Threshold for downward counting	V_{FB_HLC}	-	2.05	-	V	
Threshold for upward counting	V_{FB_LHC}	-	1.55	-	V	
Counter Time	t_{COUNT}	-	48	-	ms	
ZCD resistance	R_{ZCD}	2.5	3.0	3.5	k Ω	Internal resistor at ZCD pin
VIN voltage threshold for line selection	V_{VIN_REF}	1.48	1.52	1.58	V	
Blanking time for VIN voltage threshold for line selection	t_{VIN_REF}	-	16.00	-	ms	

¹ The parameter is not subjected to production test - verified by design/characterization

Electrical Characteristics

4.9 Active Burst Mode

Table 14 Active Burst Mode

Parameter	Symbol	Limit Values			Unit	Note / Test Condition
		Min.	Typ.	Max.		
Charging current to select burst mode	I_{sel}	2.1	3	3.9	μA	
Burst mode selection reference voltage	V_{REF_B}	2.65	2.75	2.85	V	
Feedback voltage for entering Active Burst Mode for level 1	V_{FB_EBL1}	0.86	0.90	0.94	V	
Feedback voltage for entering Active Burst Mode for level 2	V_{FB_EBL2}	1.0	1.05	1.1	V	
Blanking time for entering Active Burst Mode	t_{FB_BEB}	-	20	-	ms	
Feedback voltage for leaving Active Burst Mode	V_{FB_LB}	2.65	2.75	2.85	V	
ZCD voltage threshold for first pulse after leaving Active Burst Mode	V_{ZCD_LB}	60	100	150	mV	
Feedback voltage for burst-on	V_{FB_BOon}	2.3	2.40	2.5	V	
Feedback voltage for burst-off	V_{FB_Boff}	1.9	2.00	2.1	V	

4.10 Line Over Voltage Protection

Table 15 Line OVP

Parameter	Symbol	Limit Values			Unit	Note / Test Condition
		Min.	Typ.	Max.		
Line Over Voltage threshold	V_{VIN_LOVP}	2.8	2.9	3.0	V	
Line Over Voltage Blanking	$t_{VIN_LOVP_B}$	-	250	-	μs	

4.11 Brownout Protection

Table 16 Brownout Protection

Parameter	Symbol	Limit Values			Unit	Note / Test Condition
		Min.	Typ.	Max.		
BrownIn threshold	V_{VIN_BI}	0.63	0.66	0.69	V	
BrownIn Blanking	$t_{VIN_BI_B}$	-	250	-	μs	
BrownOut threshold	V_{VIN_BO}	0.37	0.40	0.43	V	
BrownOut Blanking	$t_{VIN_BO_B}$	-	250	-	μs	

4.12 V_{CC} Over Voltage Protection

Table 17 V_{CC} Over Voltage Protection

Electrical Characteristics

Parameter	Symbol	Limit Values			Unit	Note / Test Condition
		Min.	Typ.	Max.		
VCC Over Voltage threshold	V_{VCC_OVP}	24	25.50	27	V	
VCC Over Voltage blanking	$t_{VCC_OVP_B}$	-	50.00	-	μs	

4.13 Over Load Protection

Table 18 Overload Protection

Parameter	Symbol	Limit Values			Unit	Note / Test Condition
		Min.	Typ.	Max.		
Over Load Detection threshold for OLP protection at FB pin	V_{FB_OLP}	2.65	2.75	2.85	V	
Over Load Protection Blanking Time	$t_{FB_OLP_B}$	-	30	-	ms	

4.14 Output Over Voltage Protection

Table 19 Output OVP

Parameter	Symbol	Limit Values			Unit	Note / Test Condition
		Min.	Typ.	Max.		
Output Over Voltage threshold	V_{ZCD_OVP}	1.9	2.0	2.1	V	
Output Over Voltage Blanking Pulse	$P_{ZCD_OVP_B}$	-	10	-	pulse	Consecutive Pulse

4.15 Thermal Protection

Table 20 Thermal Protection

Parameter	Symbol	Limit Values			Unit	Note / Test Condition
		Min.	Typ.	Max.		
Over temperature protection ¹	T_{jcon_OTP}	129	140	150	°C	Junction temperature of the controller chip (not the CoolMOST™ chip)
Over temperature Hysteresis	T_{jHYS_OTP}	-	40	-	°C	
Over temperature Blanking Time	$t_{jcon_OTP_B}$	-	50	-	μs	

¹ The parameter is not subjected to production test - verified by design/characterization

Electrical Characteristics

4.16 CoolMOS™ Section

Table 21 ICE5QRxx80BG

Parameter	Symbol	Limit Values			Unit	Note / Test Condition
		Min.	Typ.	Max.		
Drain Source Breakdown Voltage ICE5QRxx80BG	$V_{(BR)DSS}$	800	-	-	V	$T_j = 25^\circ\text{C}$
Drain to CS On-Resistance (inclusive of low side MOSFET)	R_{DSon}				Ω	
ICE5QR4780BG		-	4.13	4.85		$T_j = 25^\circ\text{C}$
ICE5QR2280BG		-	8.69 ¹	-		$T_j = 125^\circ\text{C}, I_D = 0.4\text{A}$
ICE5QR1680BG		-	2.13	2.35		$T_j = 25^\circ\text{C}$
ICE5QR0680BG		-	4.31 ¹	-		$T_j = 125^\circ\text{C}, I_D = 1\text{A}$
ICE5QR0680BG		-	1.53	1.75		$T_j = 25^\circ\text{C}$
ICE5QR0680BG		-	3.01 ¹	-		$T_j = 125^\circ\text{C}, I_D = 1.4\text{A}$
ICE5QR0680BG		-	0.71	0.80		$T_j = 25^\circ\text{C}$
ICE5QR0680BG		-	1.27 ¹	-		$T_j = 125^\circ\text{C}, I_D = 2\text{A}$
Effective output capacitance, energy related ¹	$C_{o(er)}$				pF	$V_{GS} = 0\text{V}, V_{DS} = 0 \sim 500\text{V}$
ICE5QR4780BG		-	3	-		
ICE5QR2280BG		-	7	-		
ICE5QR1680BG		-	8	-		
ICE5QR0680BG		-	24	-		
Rise Time ²	t_{rise}	-	30	-	ns	
Fall Time ²	t_{fall}	-	30	-	ns	

¹The parameter is not subjected to production test - verified by design/characterization

²Measured in a Typical Flyback Converter Application

CoolMOS™ Performance Characteristics

5 CoolMOS™ Performance Characteristics

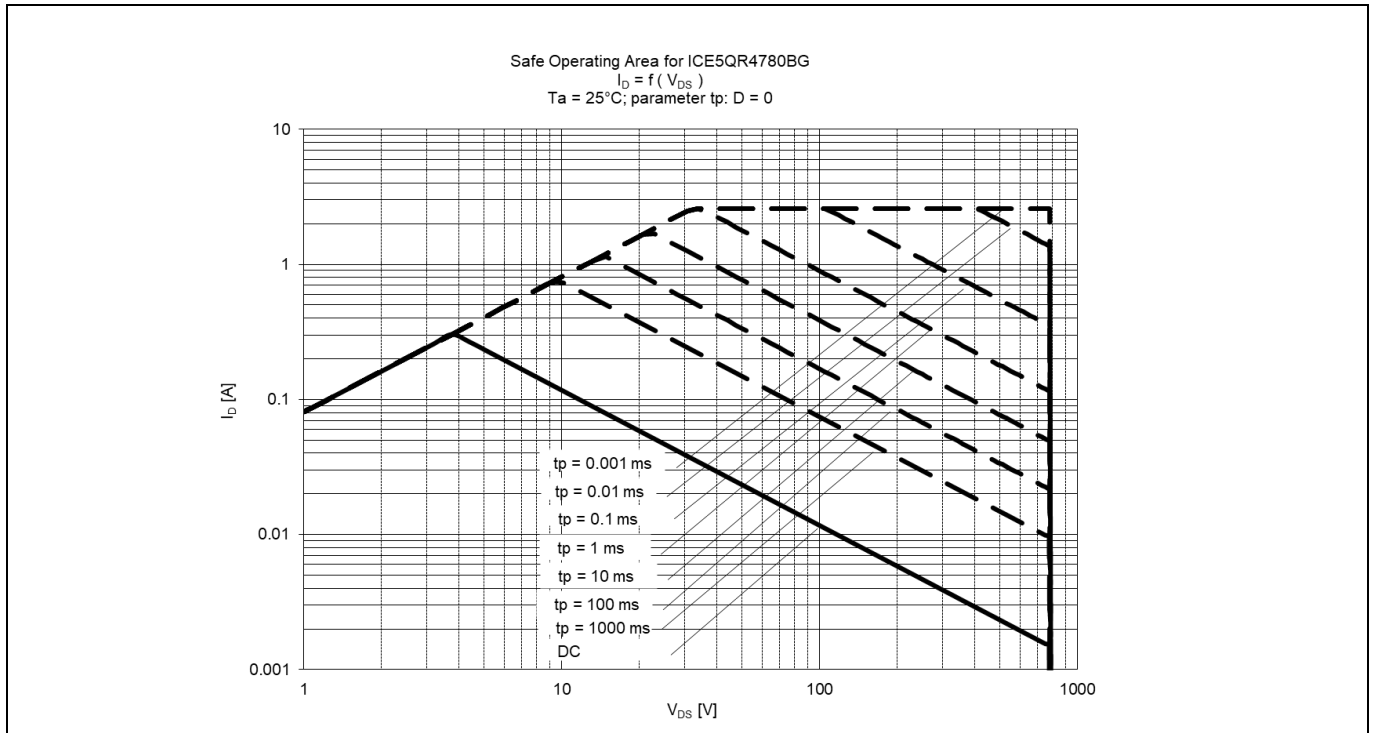

Figure 14 Safe Operating Area (SOA) curve for ICE5QR4780BG

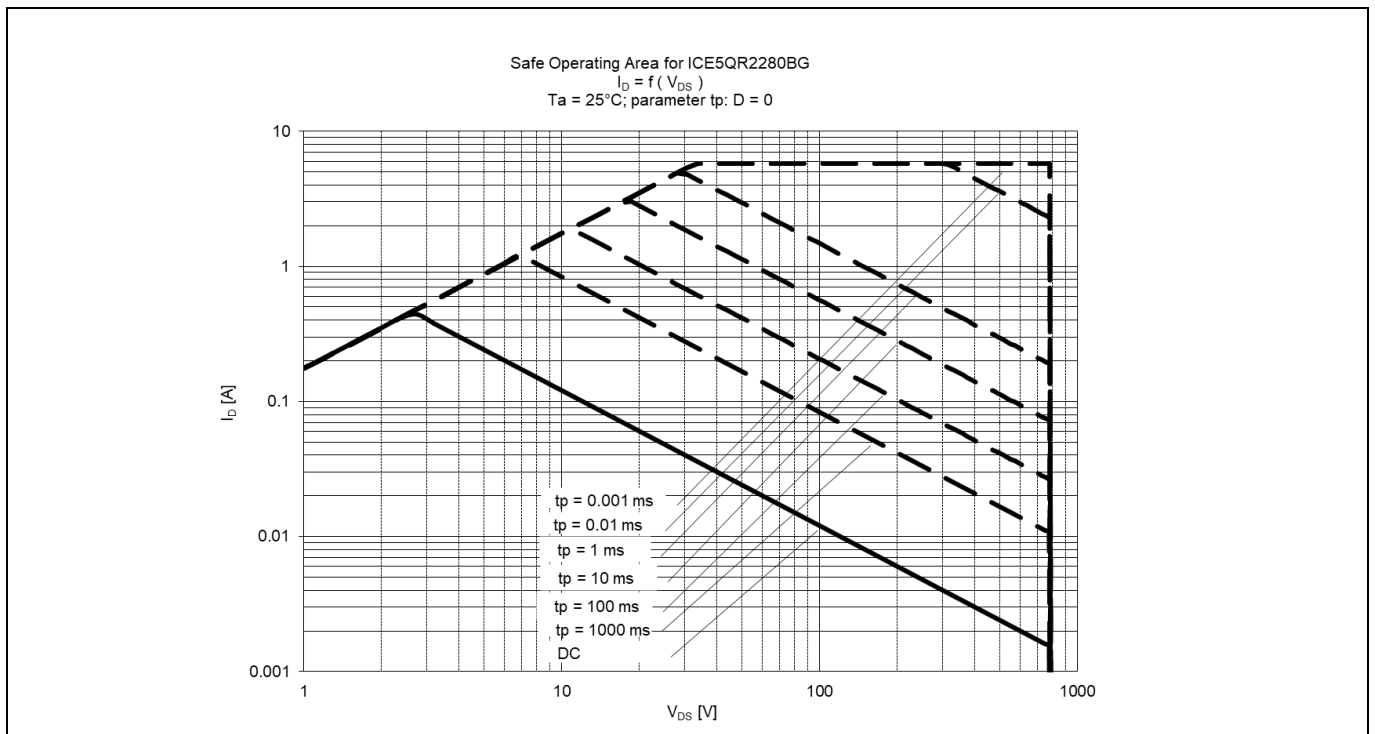

Figure 15 Safe Operating Area (SOA) curve for ICE5QR2280BG

CoolMOS™ Performance Characteristics

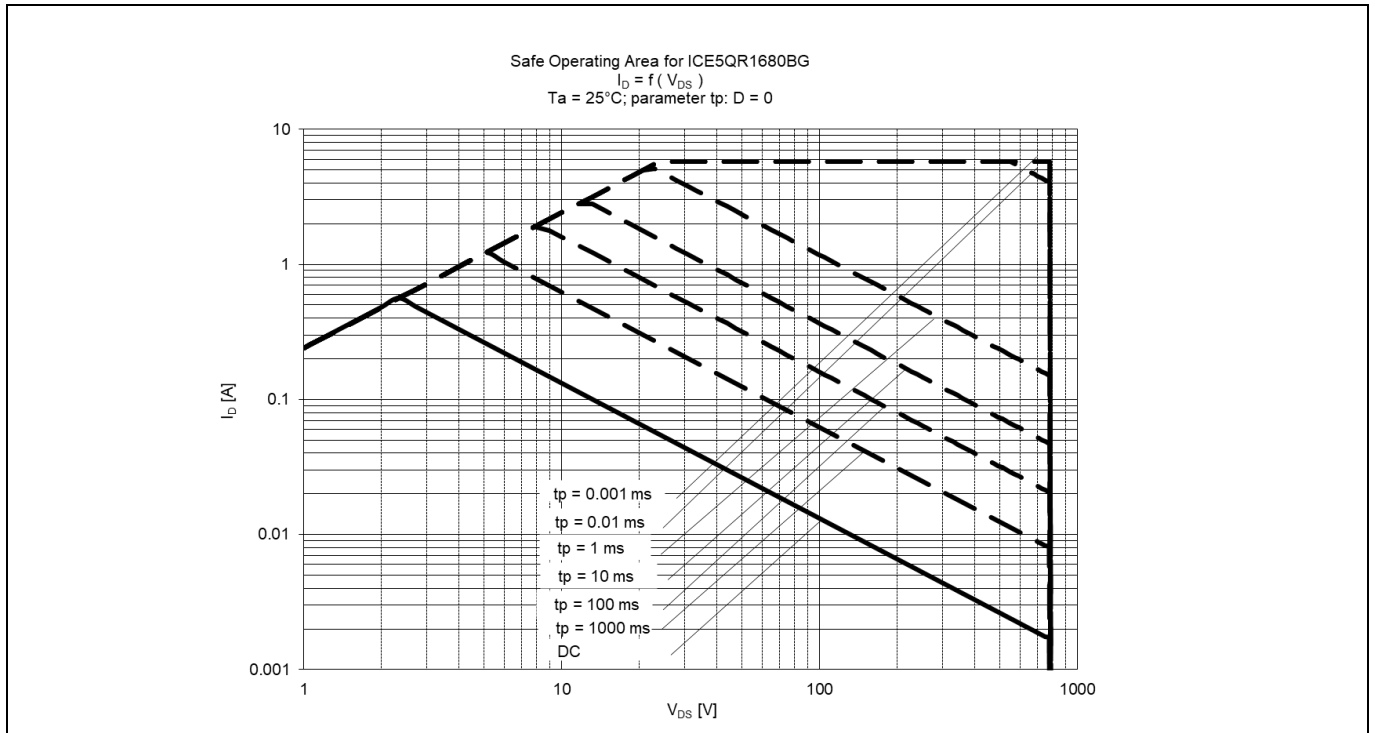

Figure 16 Safe Operating Area (SOA) curve for ICE5QR1680BG

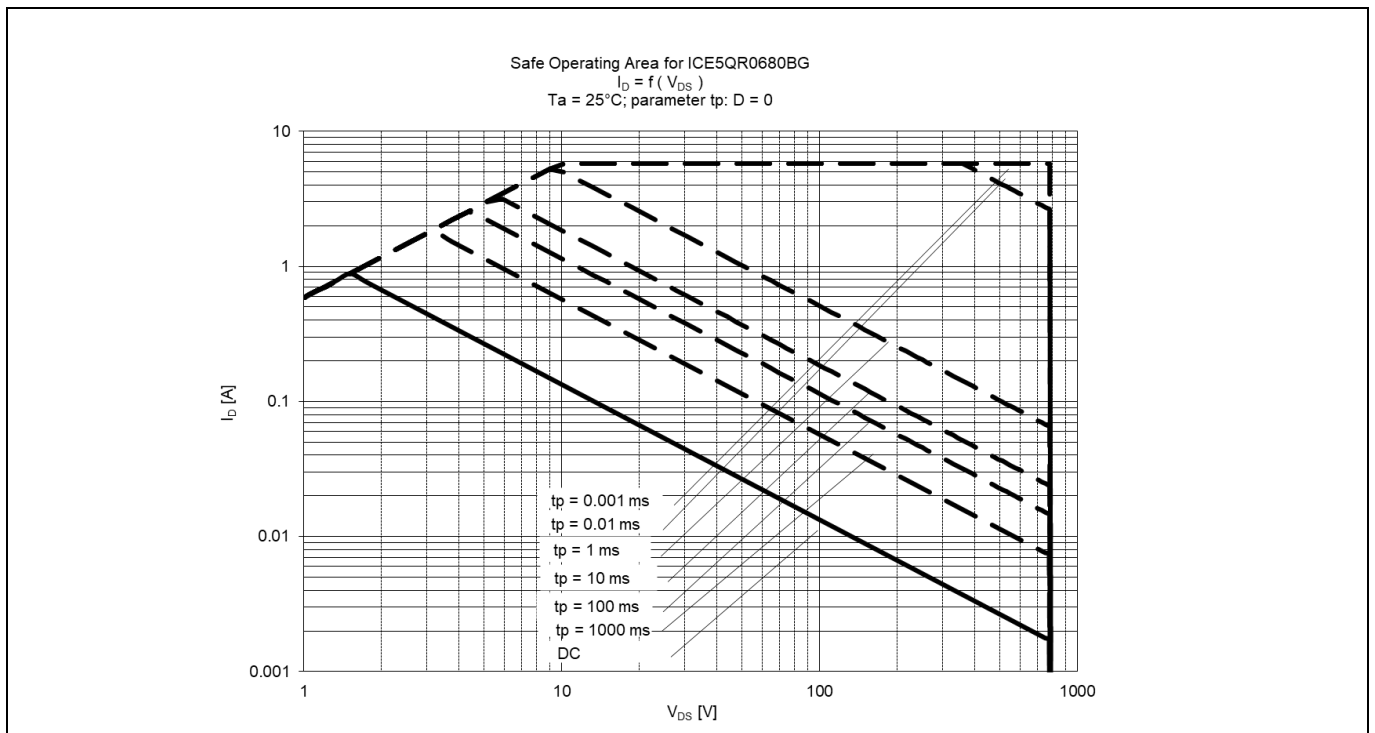

Figure 17 Safe Operating Area (SOA) curve for ICE5QR0680BG

CoolMOS™ Performance Characteristics

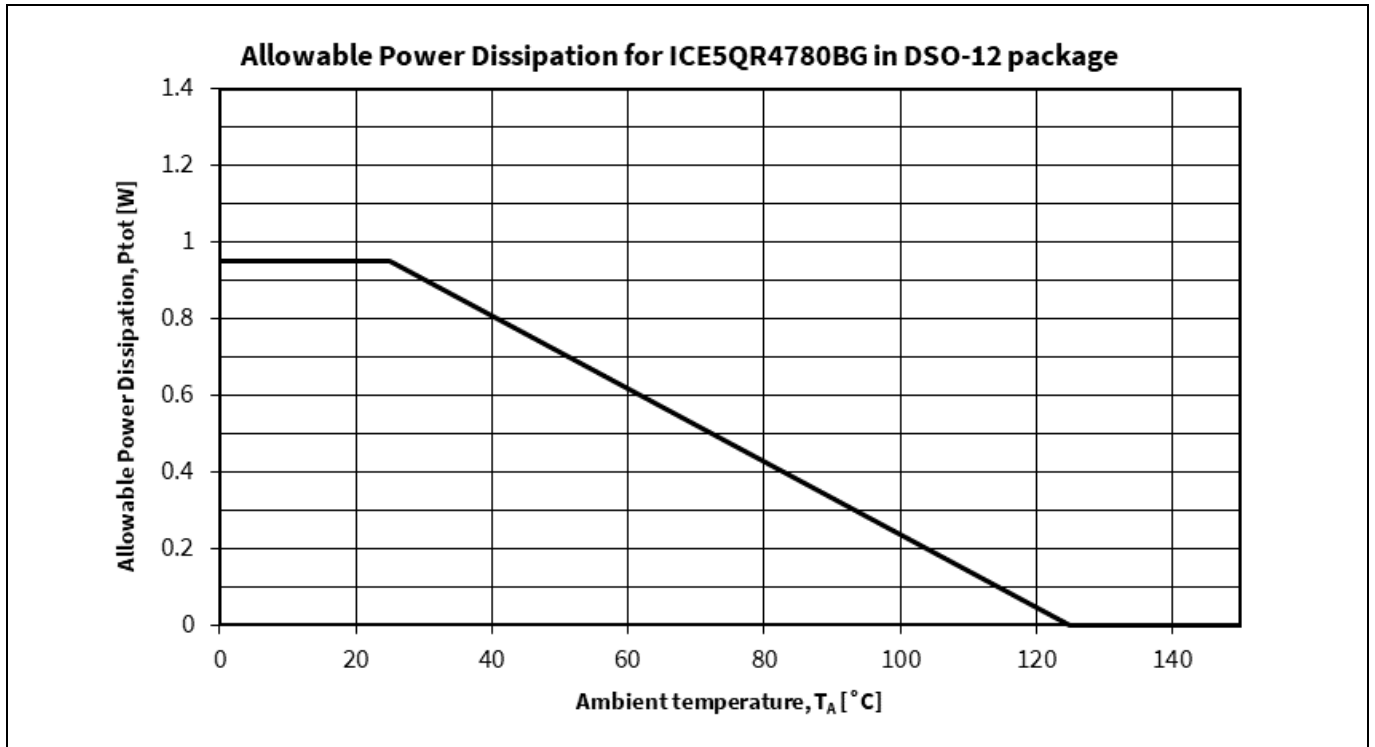

Figure 18 Power dissipation of ICE5QR4780BG, DSO-12 package; $P_{tot}=f(T_a)$, (Maximum ratings as given in section 4.1 must not be exceeded)

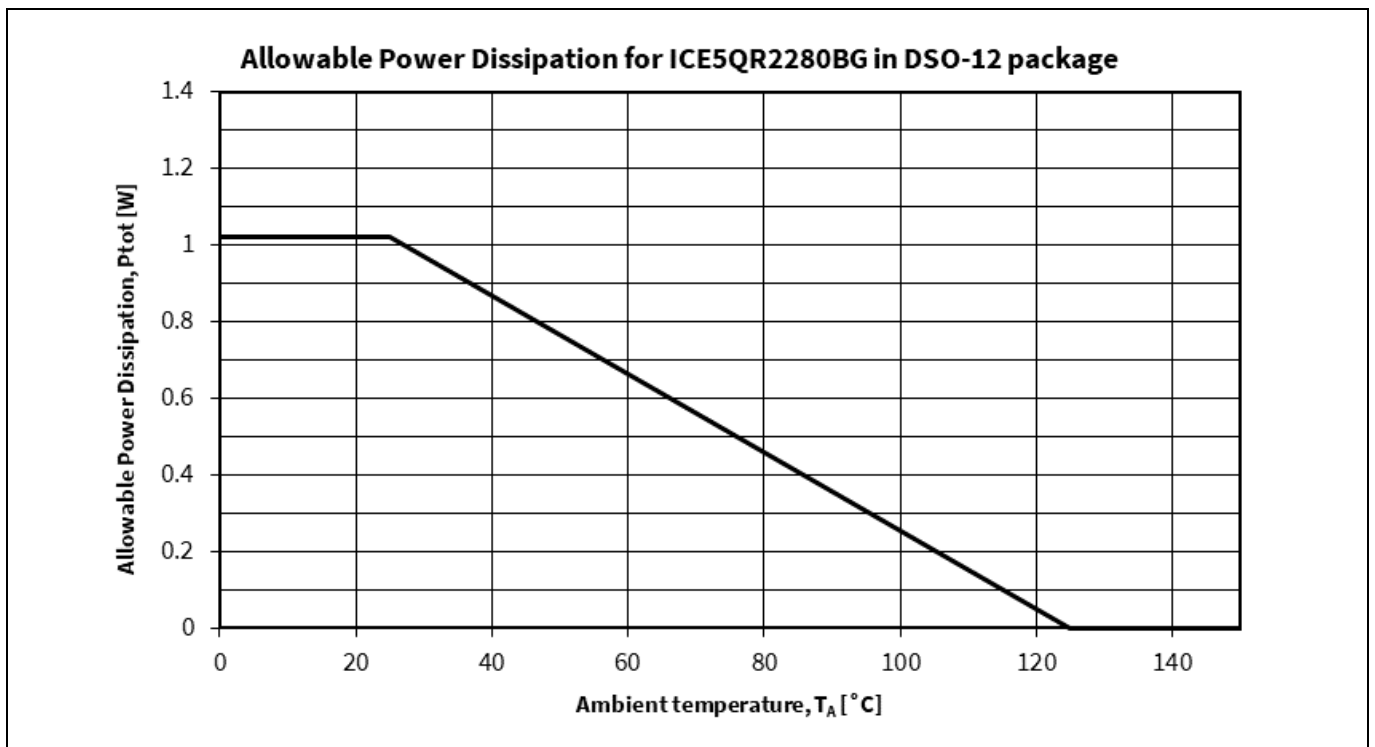

Figure 19 Power dissipation of ICE5QR2280BG, DSO-12 package; $P_{tot}=f(T_a)$, (Maximum ratings as given in section 4.1 must not be exceeded)

CoolMOS™ Performance Characteristics

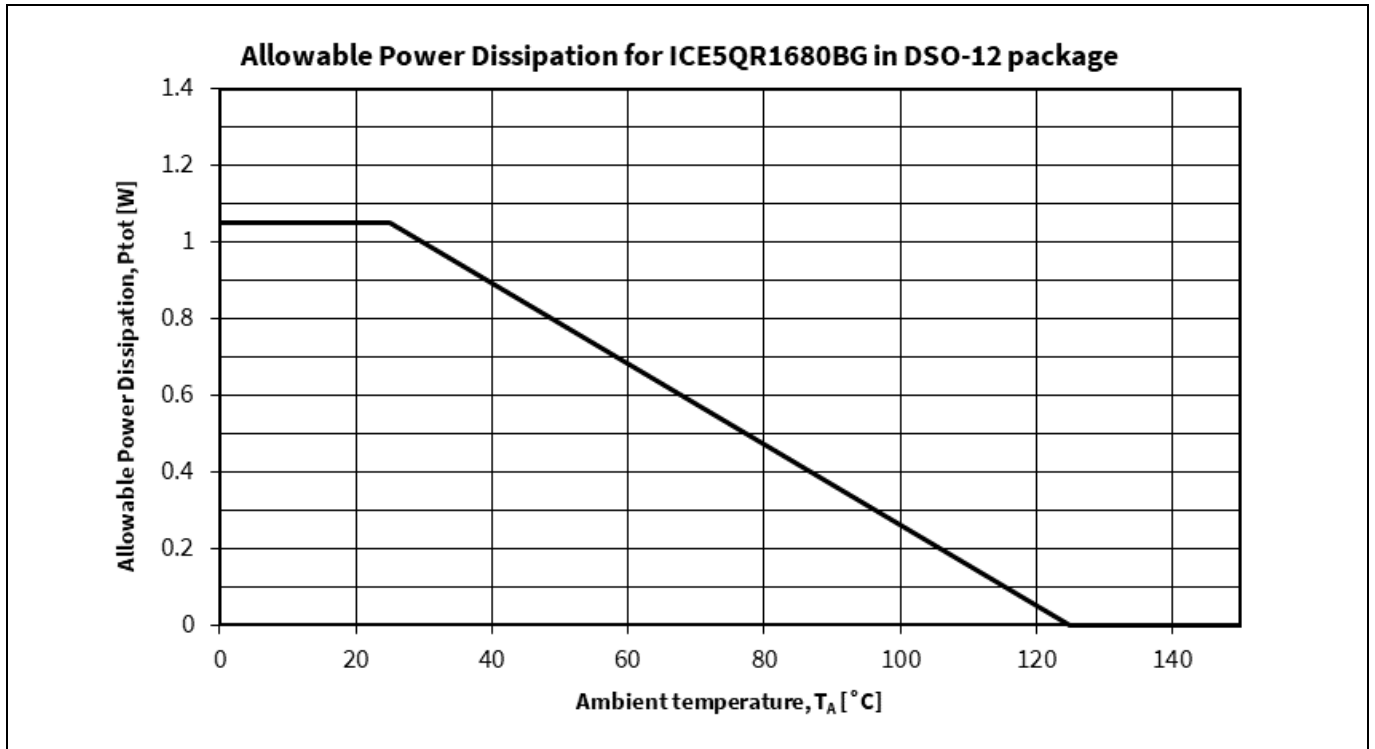

Figure 20 Power dissipation of ICE5QR1680BG, DSO-12 package; $P_{tot}=f(T_a)$, (Maximum ratings as given in section 4.1 must not be exceeded)

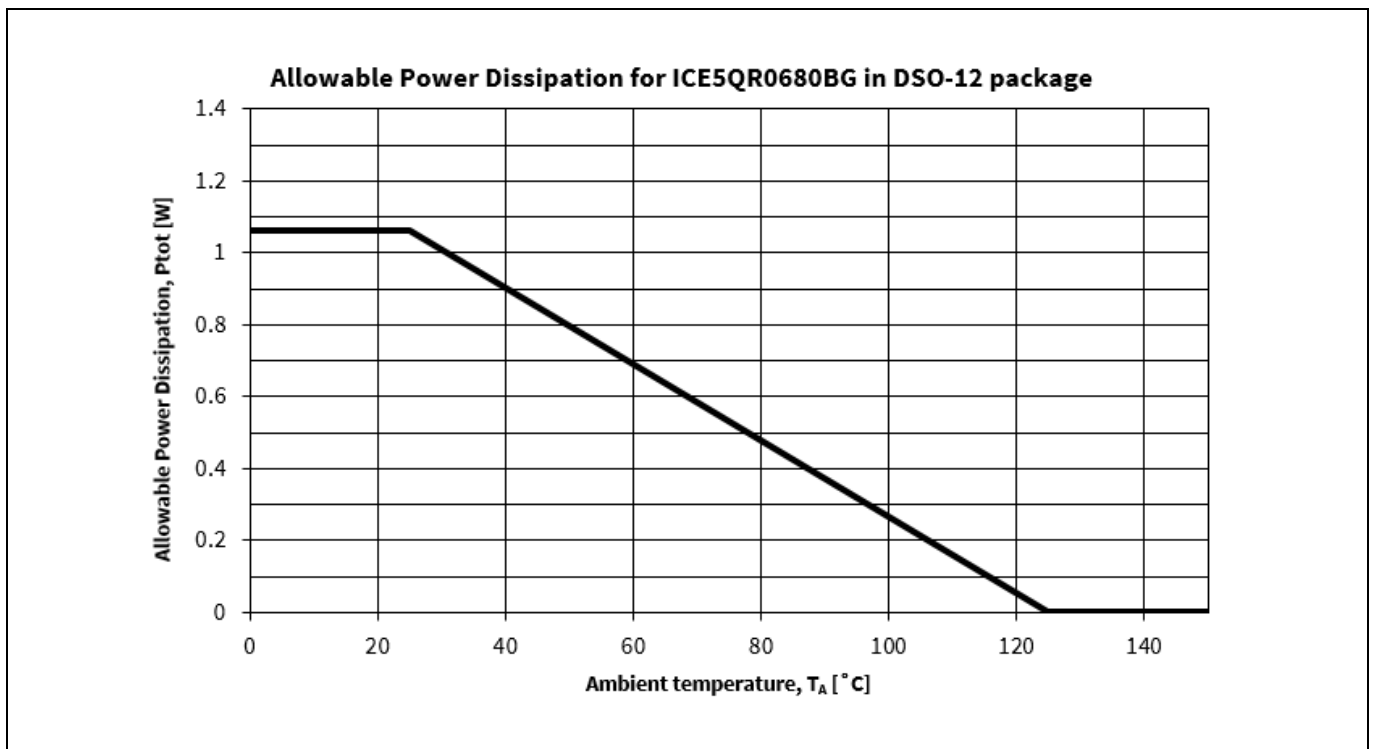

Figure 21 Power dissipation of ICE5QR0680BG, DSO-12 package; $P_{tot}=f(T_a)$, (Maximum ratings as given in section 4.1 must not be exceeded)

CoolMOS™ Performance Characteristics

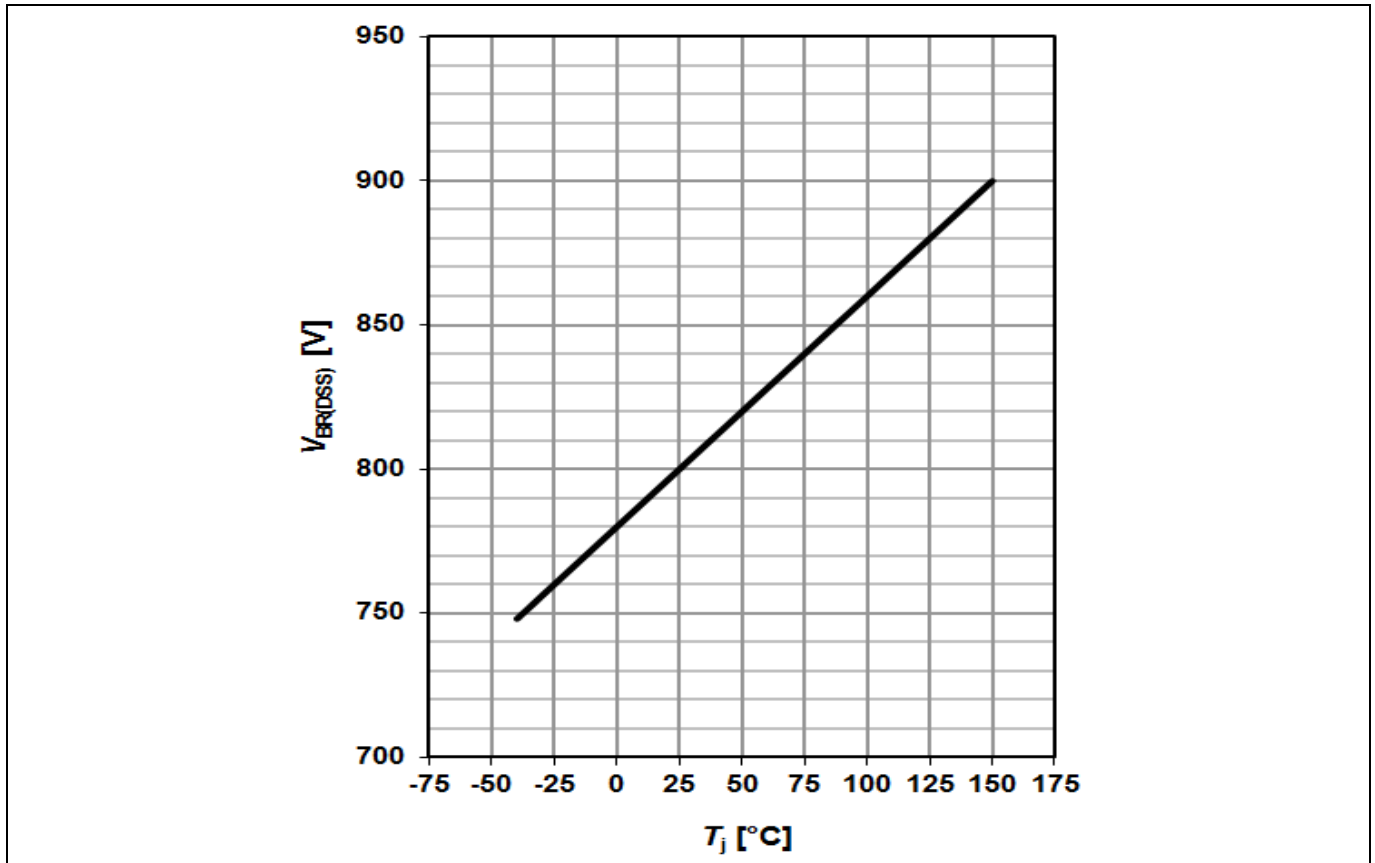

Figure 22 Drain-source breakdown voltage ICE5QRxx80BG; $V_{BR(DSS)}=f(T_j)$, $I_D=1$ mA

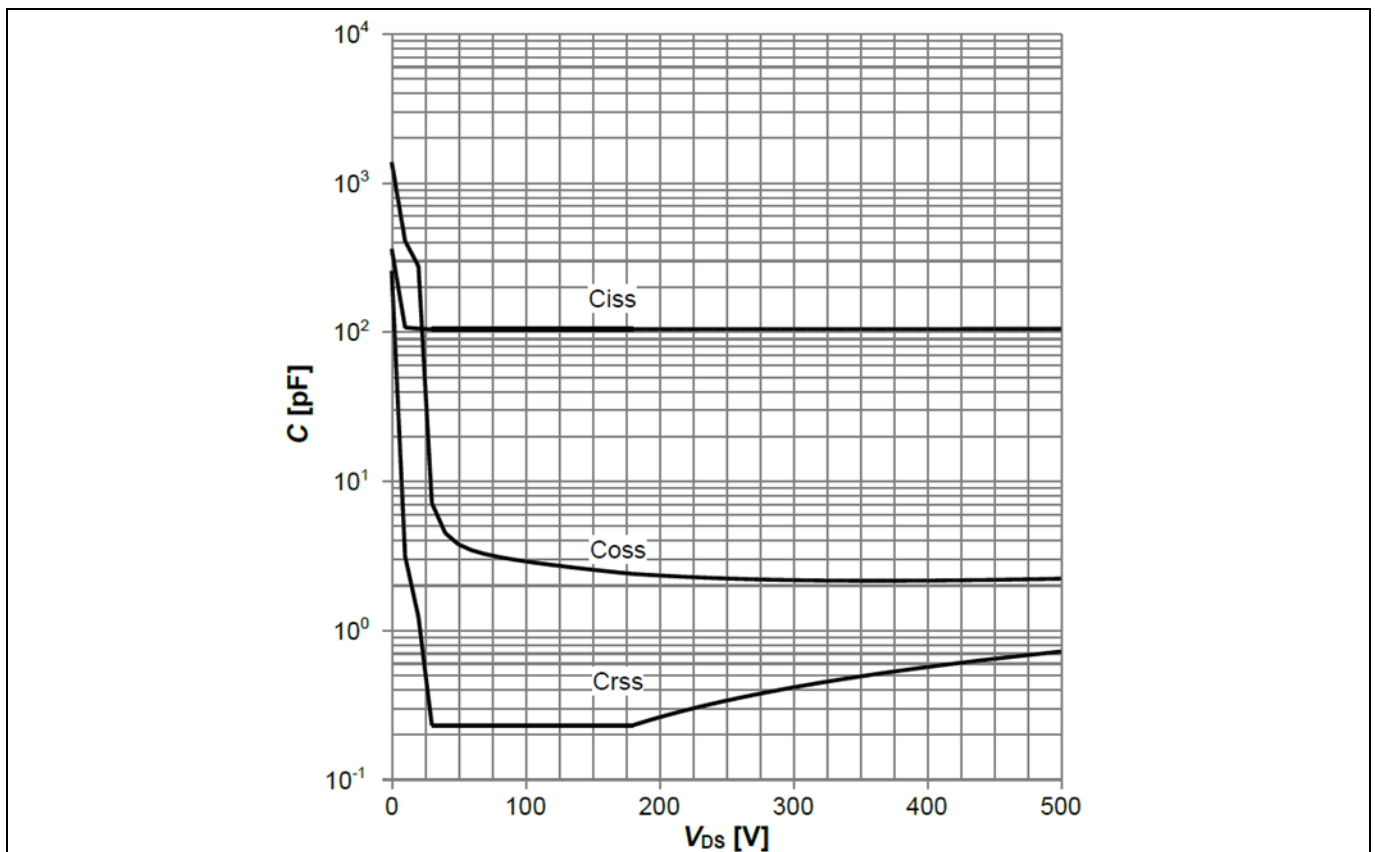

Figure 23 Typical CoolMOS™ capacitances of ICE5QR4780BG ($C=f(V_{DS}); V_{GS}=0$ V; $f=250$ kHz)

CoolMOS™ Performance Characteristics

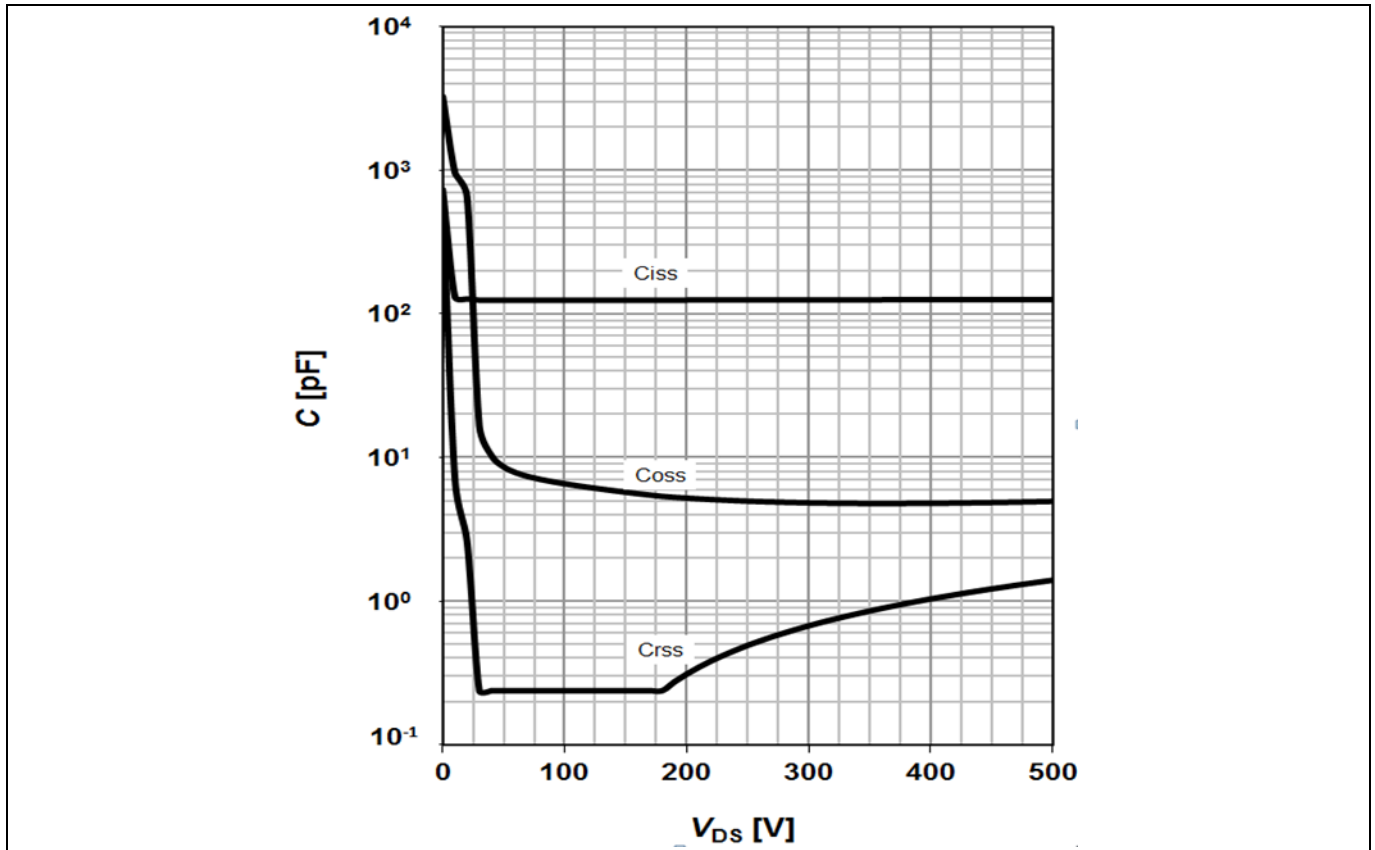

Figure 24 Typical CoolMOS™ capacitances of ICE5QR2280BG ($C=f(V_{DS}); V_{GS}=0\text{ V}; f=250\text{ kHz}$)

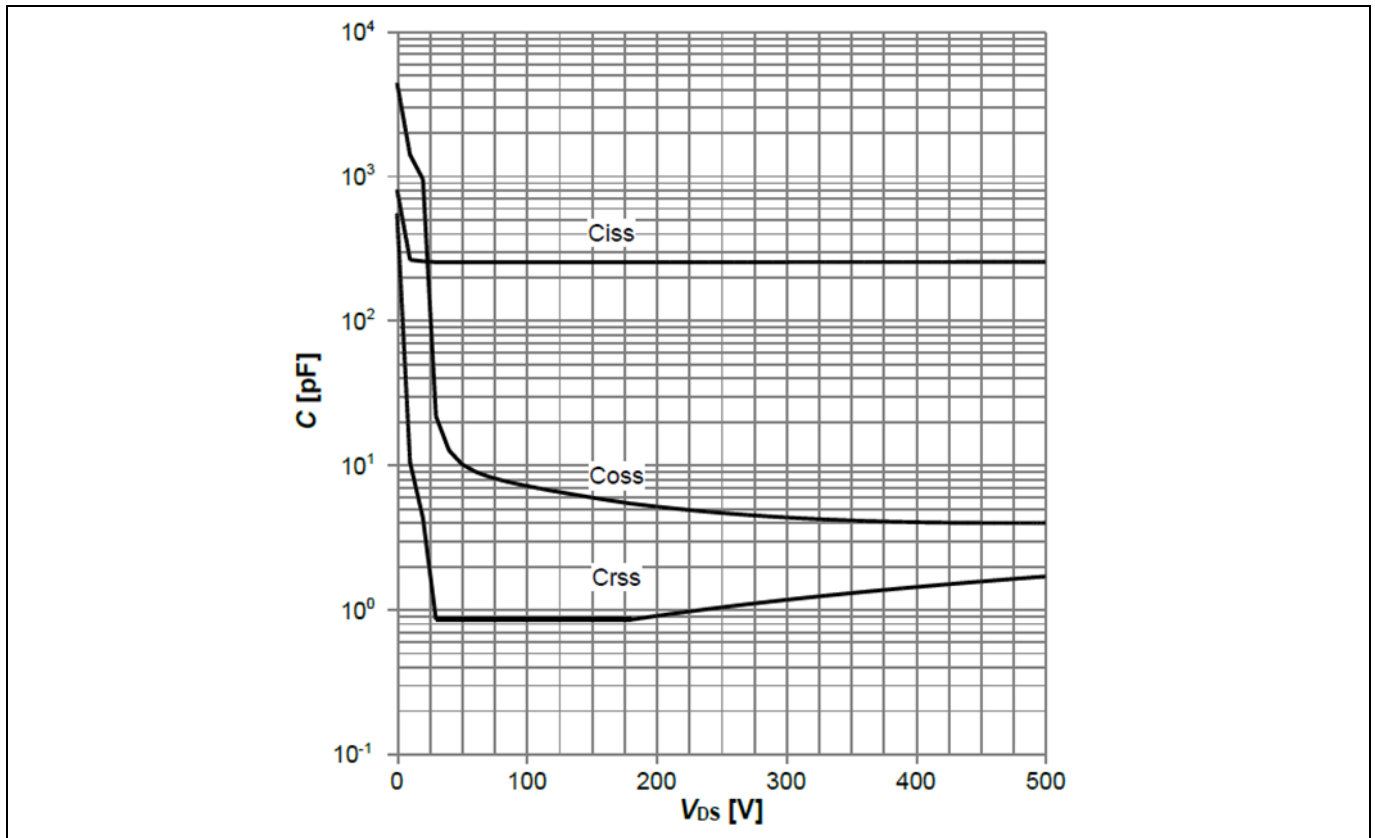

Figure 25 Typical CoolMOS™ capacitances of ICE5QR1680BG ($C=f(V_{DS}); V_{GS}=0\text{ V}; f=250\text{ kHz}$)

CoolMOS™ Performance Characteristics

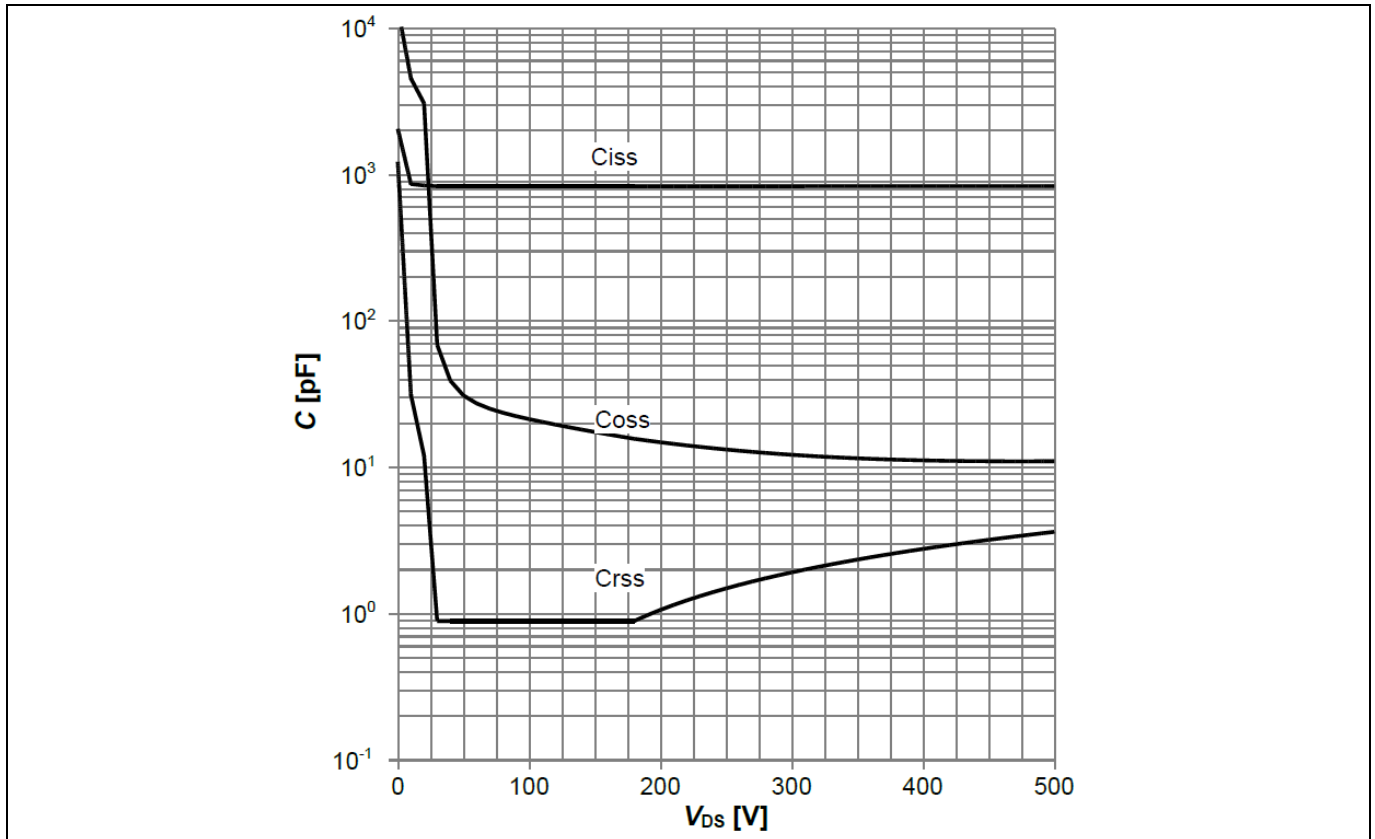

Figure 26 Typical CoolMOS™ capacitances of ICE5QR0680BG (C=f(V_{DS});V_{GS}=0 V; f=250 kHz)

Output Power Curve

6 Output Power Curve

The calculated output power curves giving the typical output power versus ambient temperature are shown below. The curves are derived based on a typical discontinuous mode flyback in an open frame design at $T_a=50^\circ\text{C}$, $T_J=125^\circ\text{C}$ (integrated high voltage MOSFET), using minimum drain pin copper area in a 2 oz copper single sided PCB and steady state operation only (no design margins for abnormal operation modes are included). The output power figure is for selection purpose only. The actual power can vary depending on particular designs. In a power supply system, appropriate thermal design margins must be applied to make sure that the maximum ratings given in section 4.1 are respected at all times.

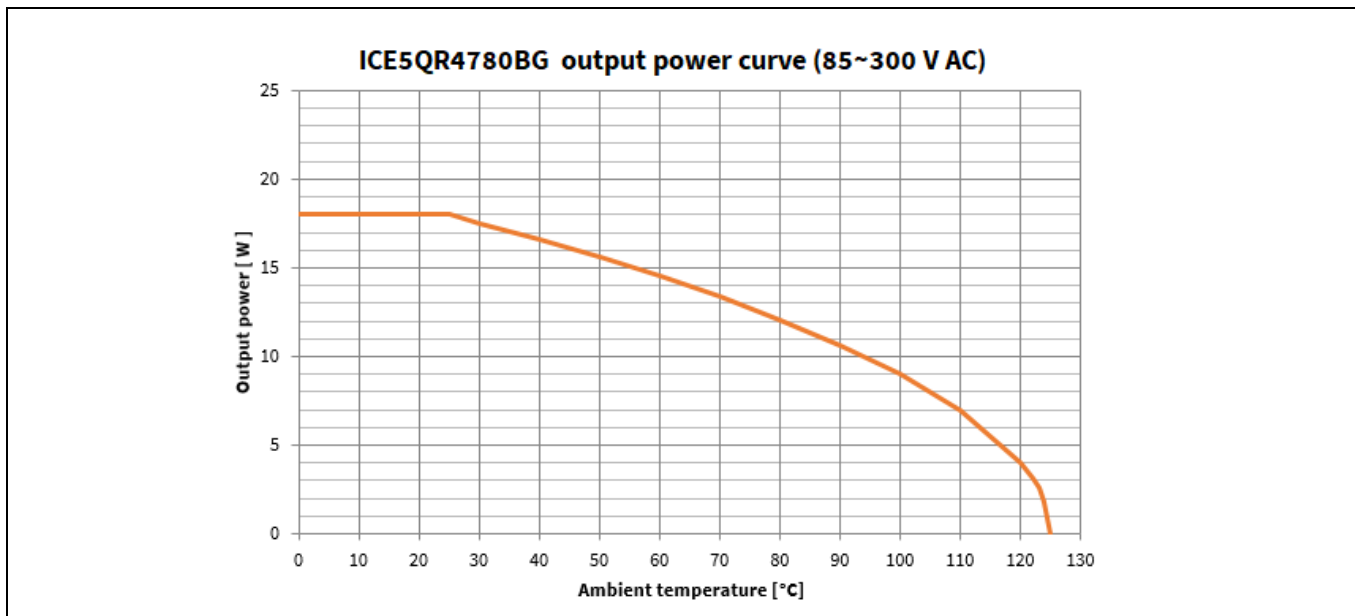

Figure 27 Output power curve of ICE5QR4780BG, $V_{IN}=85\sim 300\text{ V}_{AC}$; $P_{Out}=f(T_a)$

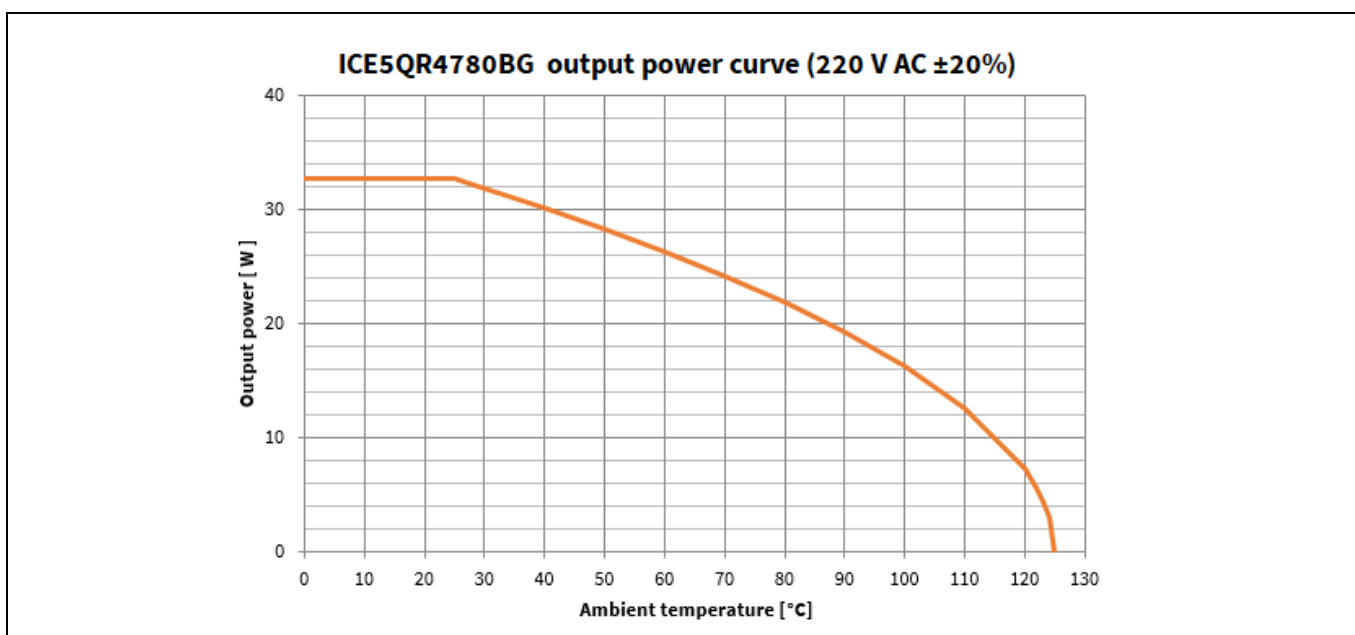

Figure 28 Output power curve of ICE5QR4780BG, $V_{IN}=220\text{ V}_{AC}$; $P_{Out}=f(T_a)$

Output Power Curve

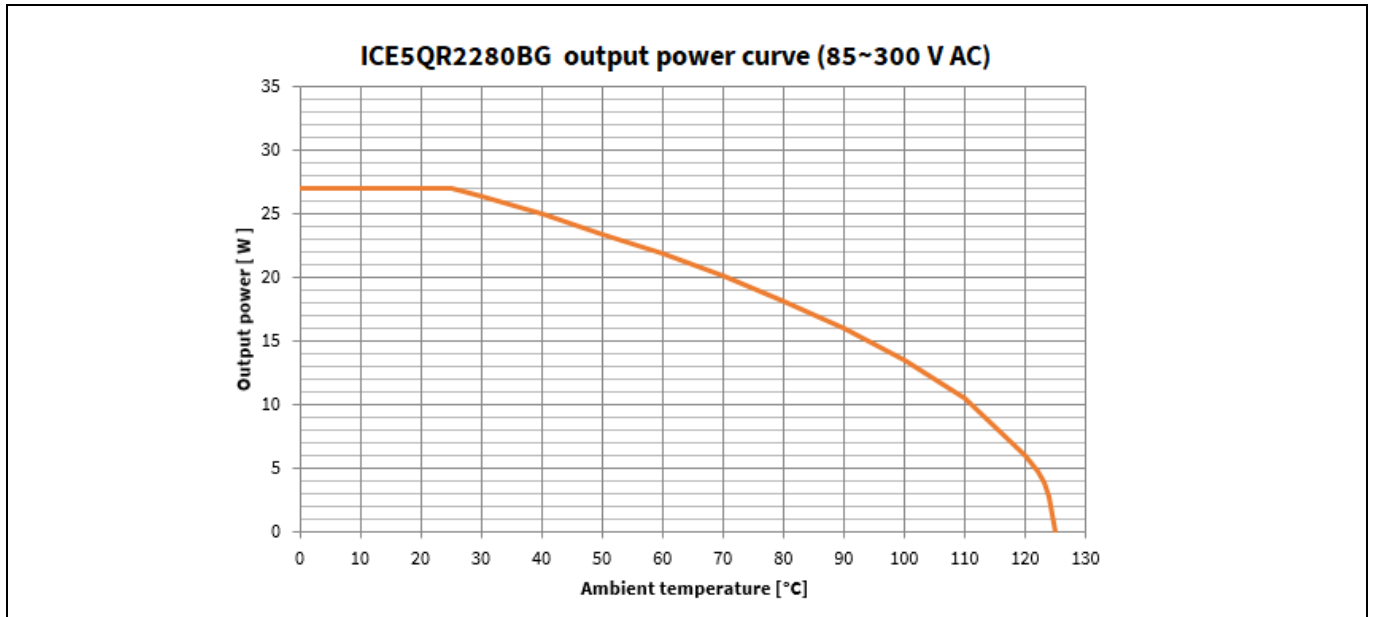

Figure 29 Output power curve of ICE5QR2280BG, $V_{IN}=85\sim 300\text{ V}_{AC}$; $P_{Out}=f(T_a)$

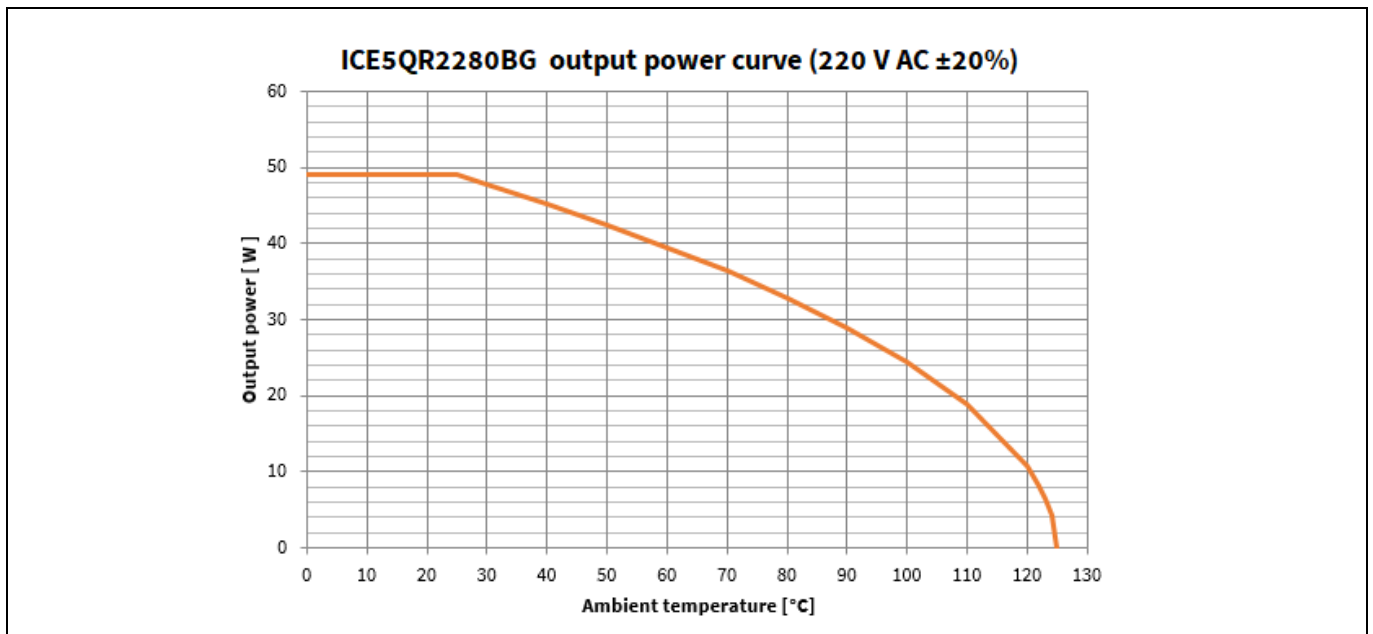

Figure 30 Output power curve of ICE5QR2280BG, $V_{IN}=220\text{ V}_{AC}$; $P_{Out}=f(T_a)$

Output Power Curve

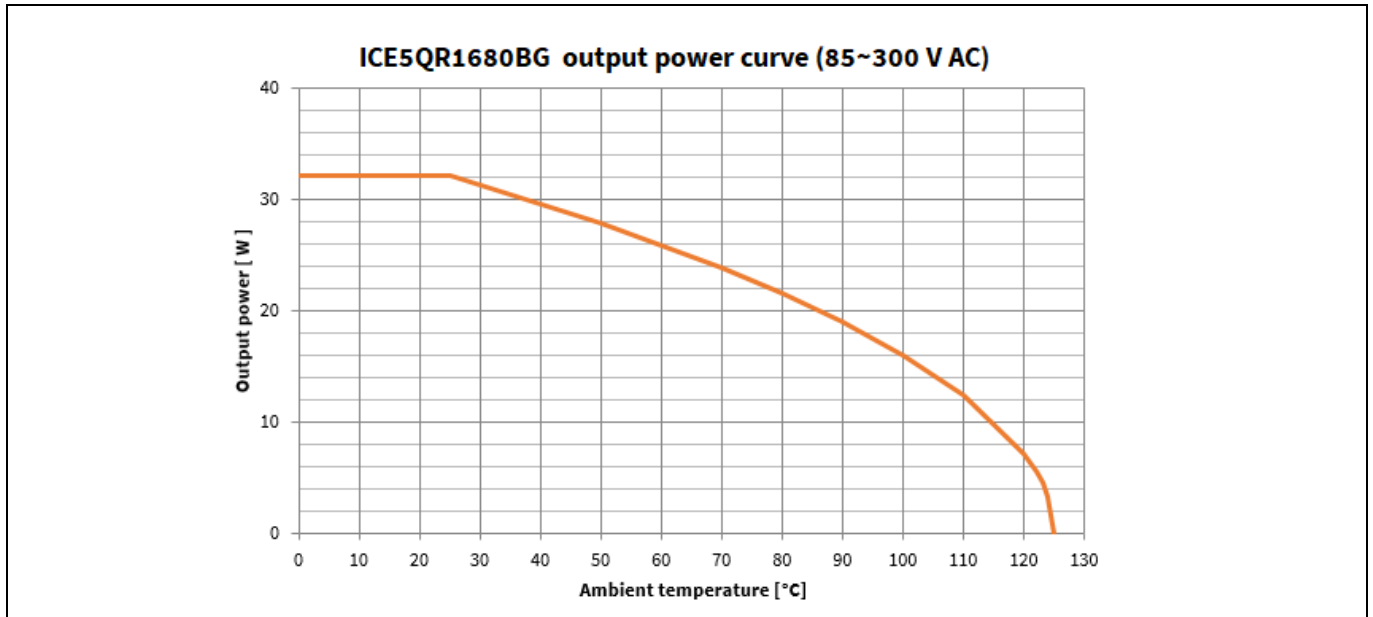

Figure 31 Output power curve of ICE5QR1680BG, $V_{IN}=85\sim 300\text{ V}_{AC}$; $P_{Out}=f(T_a)$

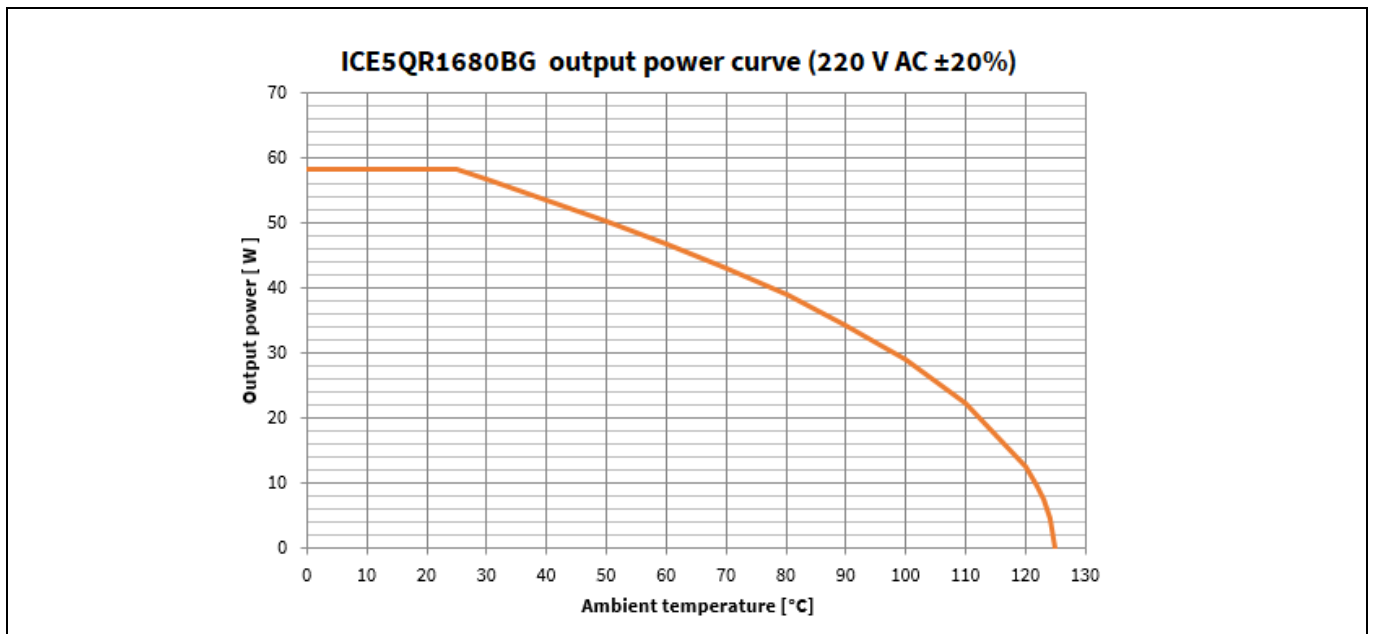

Figure 32 Output power curve of ICE5QR1680BG, $V_{IN}=220\text{ V}_{AC}$; $P_{Out}=f(T_a)$

Output Power Curve

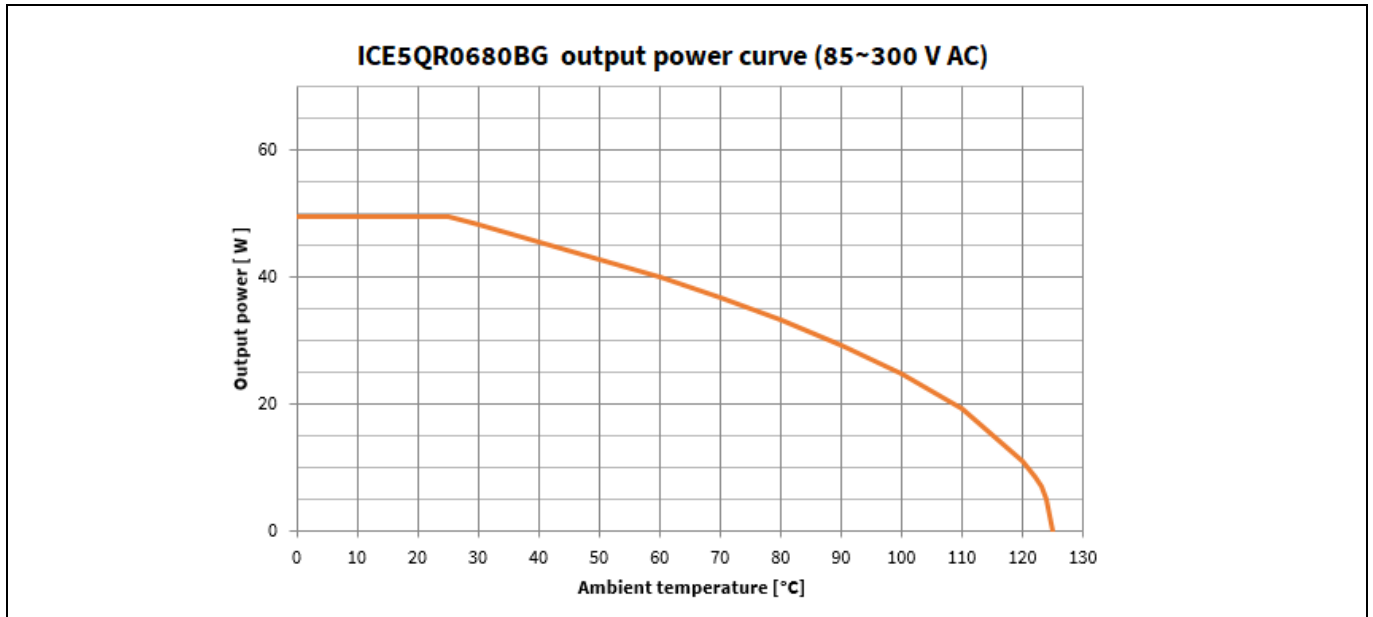

Figure 33 Output power curve of ICE5QR0680BG, $V_{IN}=85\sim 300\text{ V}_{AC}$; $P_{Out}=f(T_a)$

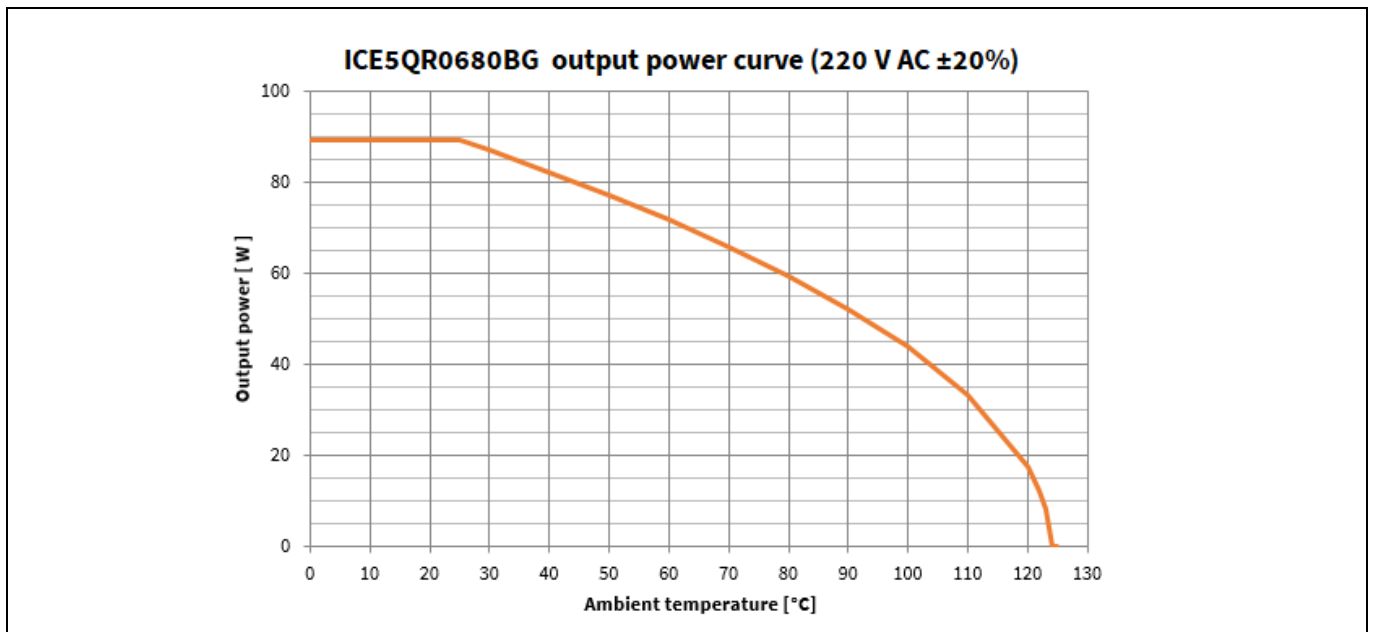

Figure 34 Output power curve of ICE5QR0680BG, $V_{IN}=220\text{ V}_{AC}$; $P_{Out}=f(T_a)$

Outline Dimension

7 Outline Dimension

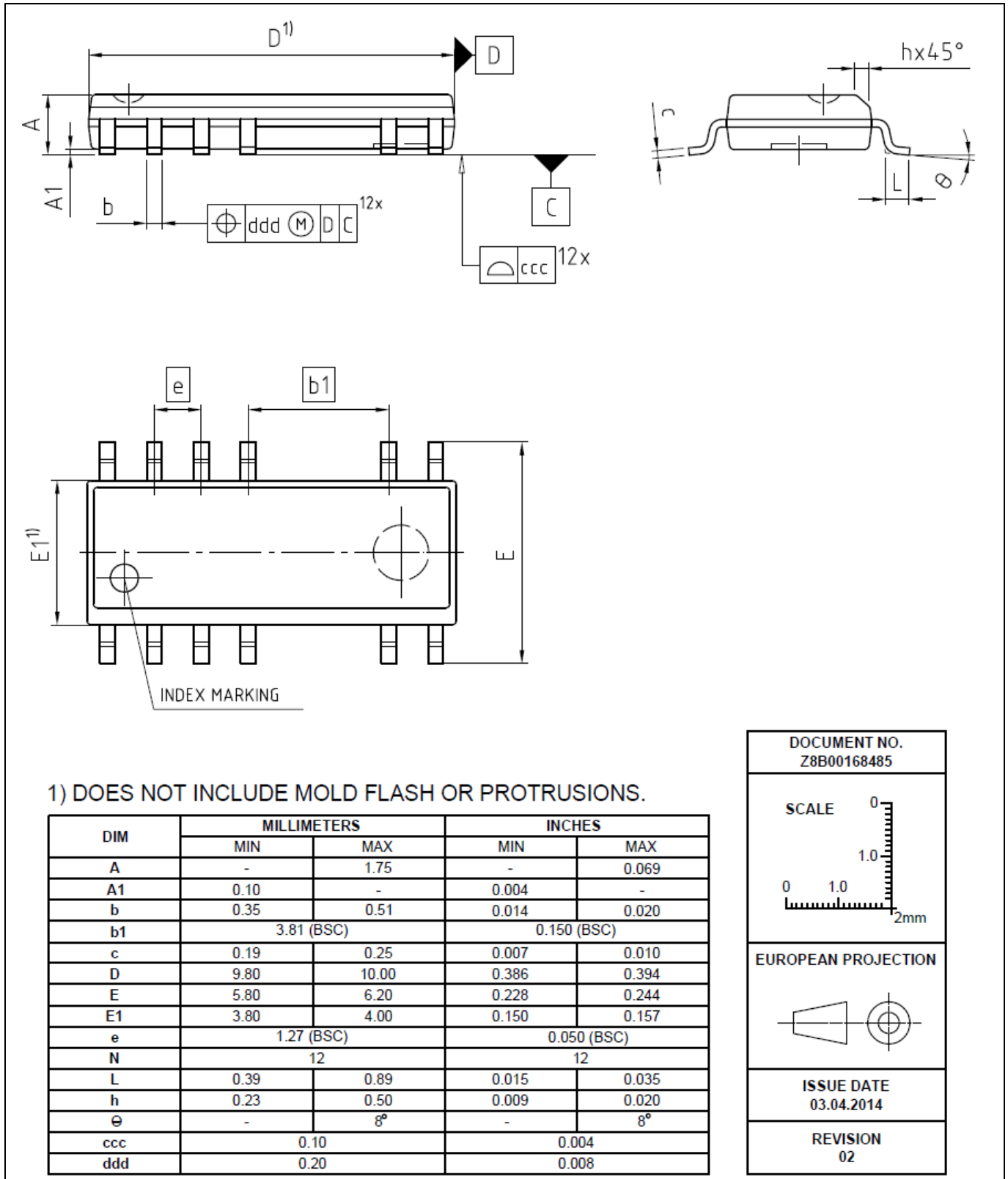

Figure 35 PG-DSO-12

Marking

8 Marking

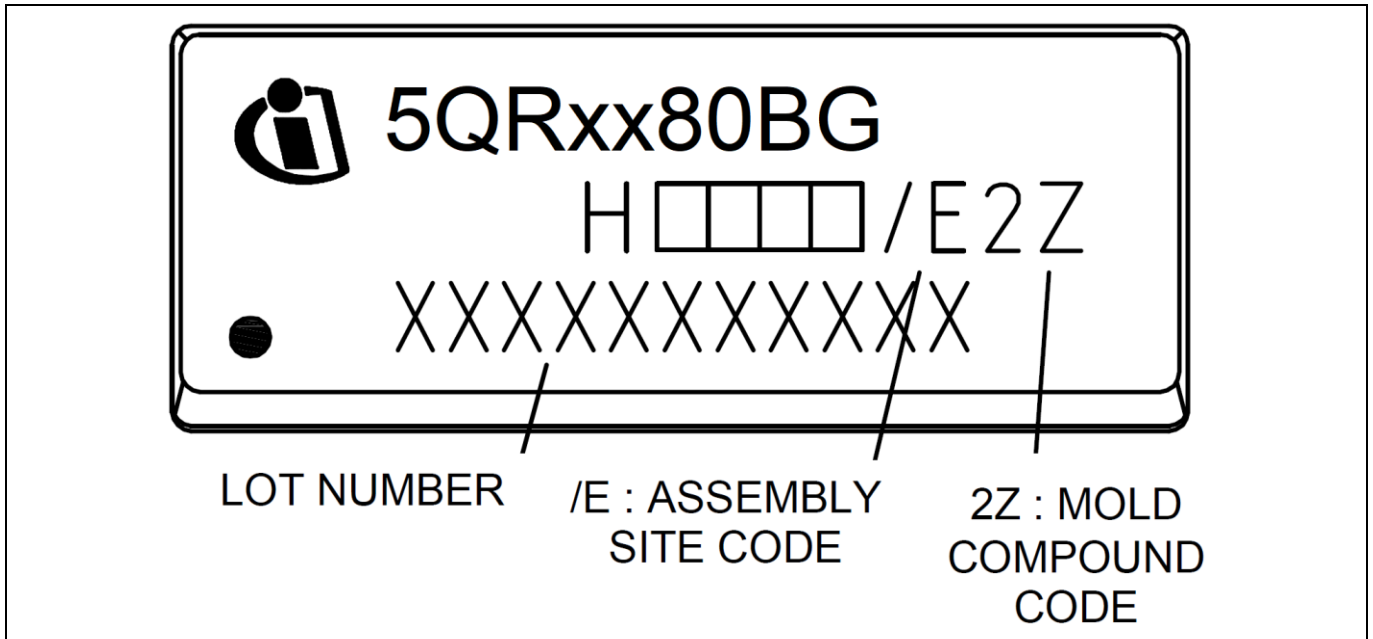

Figure 36 Marking of DSO-12

Revision history

Revision history

Document version	Date of release	Description of changes
V 2.0	30 Aug 2019	First release
V 2.1	21 Jan 2020	<ul style="list-style-type: none">• Change the name of datasheet from ICE5QR0680BG to ICE5QRxx80BG to include 3 new variants (ICE5QR4780BG, ICE5QR2280BG and ICE5QR1680BG)• Update of CS pin function and description (refer to errata sheet ES_2001_PL83_2002_024629)

Trademarks

All referenced product or service names and trademarks are the property of their respective owners.

Edition 2020-01-21

Published by

Infineon Technologies AG

81726 München, Germany

© 2020 Infineon Technologies AG.

All Rights Reserved.

Do you have a question about this document?

Email: erratum@infineon.com

Document reference

IMPORTANT NOTICE

The information given in this document shall in no event be regarded as a guarantee of conditions or characteristics ("Beschaffheitsgarantie").

With respect to any examples, hints or any typical values stated herein and/or any information regarding the application of the product, Infineon Technologies hereby disclaims any and all warranties and liabilities of any kind, including without limitation warranties of non-infringement of intellectual property rights of any third party.

In addition, any information given in this document is subject to customer's compliance with its obligations stated in this document and any applicable legal requirements, norms and standards concerning customer's products and any use of the product of Infineon Technologies in customer's applications.

The data contained in this document is exclusively intended for technically trained staff. It is the responsibility of customer's technical departments to evaluate the suitability of the product for the intended application and the completeness of the product information given in this document with respect to such application.

For further information on the product, technology, delivery terms and conditions and prices please contact your nearest Infineon Technologies office (www.infineon.com).

WARNINGS

Due to technical requirements products may contain dangerous substances. For information on the types in question please contact your nearest Infineon Technologies office.

Except as otherwise explicitly approved by Infineon Technologies in a written document signed by authorized representatives of Infineon Technologies, Infineon Technologies' products may not be used in any applications where a failure of the product or any consequences of the use thereof can reasonably be expected to result in personal injury.

单击下面可查看定价，库存，交付和生命周期等信息

[>>Infineon\(英飞凌\)](#)