

**RADIATION HARDENED
POWER MOSFET
SURFACE MOUNT (SMD-0.5)**

Product Summary

Part Number	Radiation Level	R _{DS(on)}	I _D	QPL Part Number
IRHNJ597034	100K Rads (Si)	0.085Ω	-21A	JANSR2N7520U3
IRHNJ593034	300K Rads (Si)	0.085Ω	-21A	JANSF2N7520U3

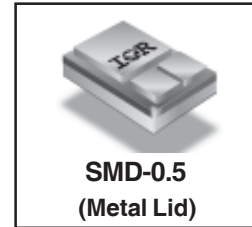

Refer to Page 8 for Additional Part Number -
IRHNJC597034 - SMD-0.5 (Ceramic Lid)

International Rectifier's R5™ technology provides high performance power MOSFETs for space applications. These devices have been characterized for Single Event Effects (SEE) with useful performance up to an LET of 80 (MeV/(mg/cm²)). The combination of low R_{DS(on)} and low gate charge reduces the power losses in switching applications such as DC to DC converters and motor control. These devices retain all of the well established advantages of MOSFETs such as voltage control, fast switching, ease of paralleling and temperature stability of electrical parameters.

Features:

- Single Event Effect (SEE) Hardened
- Ultra Low R_{DS(on)}
- Low Total Gate Charge
- Proton Tolerant
- Simple Drive Requirements
- Ease of Paralleling
- Hermetically Sealed
- Surface Mount
- Ceramic Package
- Light Weight
- ESD Rating: Class 1C per MIL-STD-750, Method 1020

Absolute Maximum Ratings

Pre-Irradiation

	Parameter		Units
I _D @ V _{GS} = -12V, T _C = 25°C	Continuous Drain Current	-21	A
I _D @ V _{GS} = -12V, T _C = 100°C	Continuous Drain Current	-13.3	
I _{DM}	Pulsed Drain Current ①	-84	
P _D @ T _C = 25°C	Max. Power Dissipation	75	W
	Linear Derating Factor	0.6	W/°C
V _{GS}	Gate-to-Source Voltage	±20	V
EAS	Single Pulse Avalanche Energy ②	110	mJ
I _{AR}	Avalanche Current ①	-21	A
EAR	Repetitive Avalanche Energy ①	7.5	mJ
dv/dt	Peak Diode Recovery dv/dt ③	-2.0	V/ns
T _J	Operating Junction	-55 to 150	°C
T _{STG}	Storage Temperature Range		
	Pckg. Mounting Surface Temp.	300 (for 5s)	
	Weight	1.0 (Typical)	g

For footnotes refer to the last page

www.irf.com

Electrical Characteristics @ T_j = 25°C (Unless Otherwise Specified)

	Parameter	Min	Typ	Max	Units	Test Conditions
BV _{DSS}	Drain-to-Source Breakdown Voltage	-60	—	—	V	V _{GS} = 0V, I _D = -1.0mA
ΔBV _{DSS} /ΔT _J	Temperature Coefficient of Breakdown Voltage	—	0.063	—	V/°C	Reference to 25°C, I _D = -1.0mA
R _{DSON}	Static Drain-to-Source On-State Resistance	—	—	0.085	Ω	V _{GS} = -12V, I _D = -13.3A ^④
V _{GS(th)}	Gate Threshold Voltage	-2.0	—	-4.0	V	V _{DS} = V _{GS} , I _D = -1.0mA
g _{fs}	Forward Transconductance	10	—	—	S	V _{DS} = -15V, I _{DS} = -13.3A ^④
I _{DSS}	Zero Gate Voltage Drain Current	—	—	-10	μA	V _{DS} = -48V, V _{GS} = 0V
		—	—	-25		V _{DS} = -48V, V _{GS} = 0V, T _J = 125°C
I _{GSS}	Gate-to-Source Leakage Forward	—	—	-100	nA	V _{GS} = -20V
I _{GSS}	Gate-to-Source Leakage Reverse	—	—	100		V _{GS} = 20V
Q _g	Total Gate Charge	—	—	45	nC	V _{GS} = -12V, I _D = -21A
Q _{gs}	Gate-to-Source Charge	—	—	18		V _{DS} = -30V
Q _{gd}	Gate-to-Drain ('Miller') Charge	—	—	13		
t _{d(on)}	Turn-On Delay Time	—	—	25	ns	V _{DD} = -30V, I _D = -21A, V _{GS} = -12V, R _G = 7.5Ω,
t _r	Rise Time	—	—	65		
t _{d(off)}	Turn-Off Delay Time	—	—	75		
t _f	Fall Time	—	—	50		
L _S + L _D	Total Inductance	—	4.0	—	nH	Measured from the center of drain pad to center of source pad
C _{iss}	Input Capacitance	—	1540	—	pF	V _{GS} = 0V, V _{DS} = -25V f = 1.0MHz
C _{oss}	Output Capacitance	—	590	—		
C _{rss}	Reverse Transfer Capacitance	—	60	—		

Source-Drain Diode Ratings and Characteristics

	Parameter	Min	Typ	Max	Units	Test Conditions
I _S	Continuous Source Current (Body Diode)	—	—	-21	A	T _J = 25°C, I _S = -21A, V _{GS} = 0V ^④
I _{SM}	Pulse Source Current (Body Diode) ^①	—	—	-84		
V _{SD}	Diode Forward Voltage	—	—	-5.0	V	T _J = 25°C, I _F = -21A, di/dt ≤ -100A/μs
t _{rr}	Reverse Recovery Time	—	—	100	ns	V _{DD} ≤ -25V ^④
Q _{RR}	Reverse Recovery Charge	—	—	200	nC	
t _{on}	Forward Turn-On Time	Intrinsic turn-on time is negligible. Turn-on speed is substantially controlled by L _S + L _D .				

Thermal Resistance

	Parameter	Min	Typ	Max	Units	Test Conditions
R _{thJC}	Junction-to-Case	—	—	1.67	°C/W	soldered to a 2" sq. copper-clad board
R _{thJ-PCB}	Junction-to-PC board	—	6.9	—		

Note: Corresponding Spice and Saber models are available on International Rectifier website.

For footnotes refer to the last page

Radiation Characteristics

IRHNJ597034, JANSR2N7520U3

International Rectifier Radiation Hardened MOSFETs are tested to verify their radiation hardness capability. The hardness assurance program at International Rectifier is comprised of two radiation environments. Every manufacturing lot is tested for total ionizing dose (per notes 5 and 6) using the TO-3 package. Both pre- and post-irradiation performance are tested and specified using the same drive circuitry and test conditions in order to provide a direct comparison.

Table 1. Electrical Characteristics @ Tj = 25°C, Post Total Dose Irradiation ⑤⑥

	Parameter	100K Rads(Si) ¹		300KRads(Si) ²		Units	Test Conditions
		Min	Max	Min	Max		
BV _{DSS}	Drain-to-Source Breakdown Voltage	-60	—	-60	—	V	V _{GS} = 0V, I _D = -1.0mA
V _{GS(th)}	Gate Threshold Voltage	-2.0	-4.0	-2.0	-5.0		V _{GS} = V _{DS} , I _D = -1.0mA
I _{GSS}	Gate-to-Source Leakage Forward	—	-100	—	-100	nA	V _{GS} = -20V
I _{GSS}	Gate-to-Source Leakage Reverse	—	100	—	100		V _{GS} = 20 V
I _{DSS}	Zero Gate Voltage Drain Current	—	-10	—	-10	μA	V _{DS} = -48V, V _{GS} = 0V
R _{DS(on)}	Static Drain-to-Source ④ On-State Resistance (TO-3)	—	0.087	—	0.087	Ω	V _{GS} = -12V, I _D = -13.3A
R _{DS(on)}	Static Drain-to-Source ④ On-State Resistance (SMD-0.5)	—	0.085	—	0.085	Ω	V _{GS} = -12V, I _D = -13.3A
V _{SD}	Diode Forward Voltage ④	—	-5.0	—	-5.0	V	V _{GS} = 0V, I _S = -21A

1. Part number IRHNJ597034 and additional part number listed on page 8
2. Part number IRHNJ593034 and additional part number listed on page 8

International Rectifier radiation hardened MOSFETs have been characterized in heavy ion environment for Single Event Effects (SEE). Single Event Effects characterization is illustrated in Fig. a and Table 2.

Table 2. Typical Single Event Effect Safe Operating Area

LET (MeV/(mg/cm ²))	Energy (MeV)	Range (μm)	VDS (V)				
			@VGS = 0V	@VGS = 5V	@VGS = 10V	@VGS = 15V	@VGS = 20V
38 ± 5%	270 ± 7.5%	35 ± 7.5%	-60	-60	-60	-60	-60
61 ± 5%	330 ± 7.5%	30 ± 7.5%	-60	-60	-60	-45	-25
84 ± 5%	350 ± 10%	28 ± 7.5%	-60	-60	-60	-	-

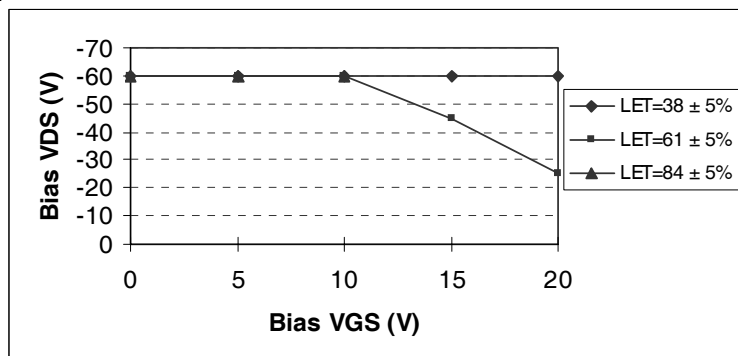

Fig a. Typical Single Event Effect, Safe Operating Area

For footnotes refer to the last page

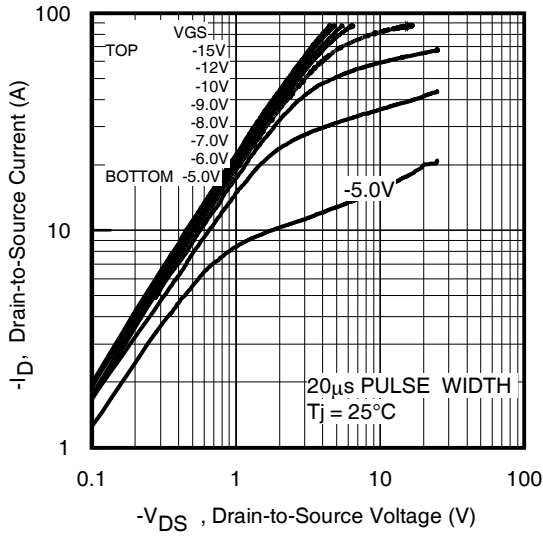

Fig 1. Typical Output Characteristics

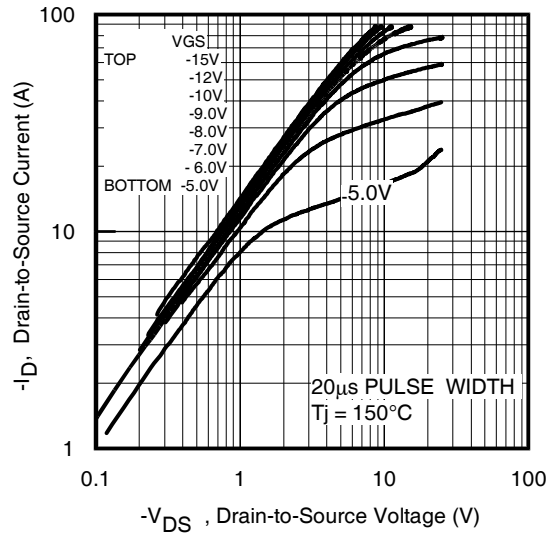

Fig 2. Typical Output Characteristics

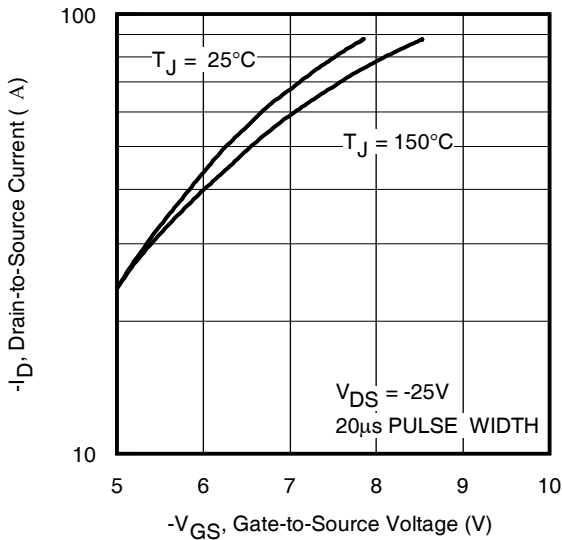

Fig 3. Typical Transfer Characteristics

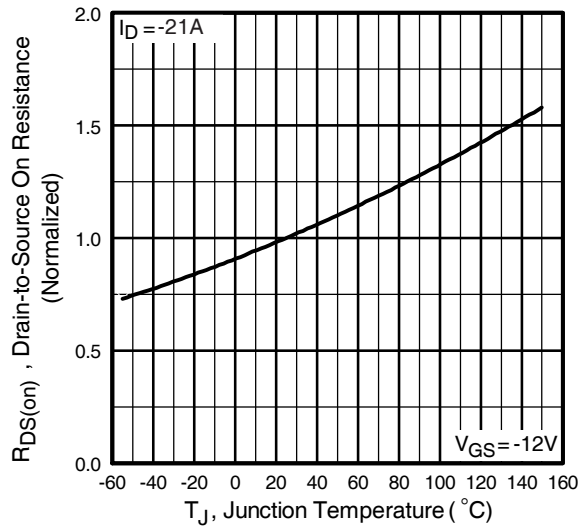

Fig 4. Normalized On-Resistance Vs. Temperature

Pre-Irradiation

IRHNJ597034, JANSR2N7520U3

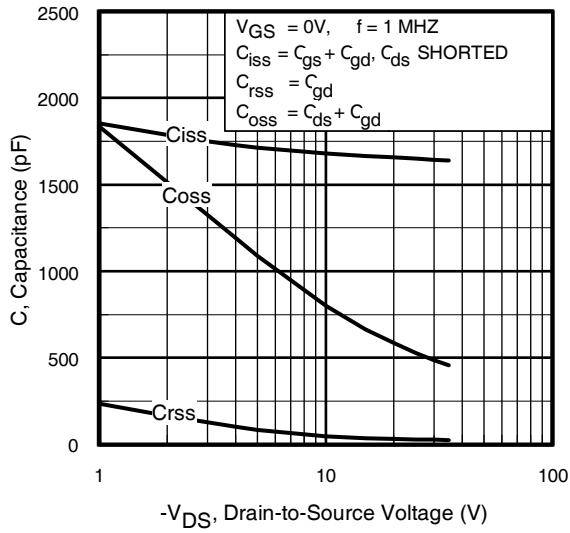

Fig 5. Typical Capacitance Vs. Drain-to-Source Voltage

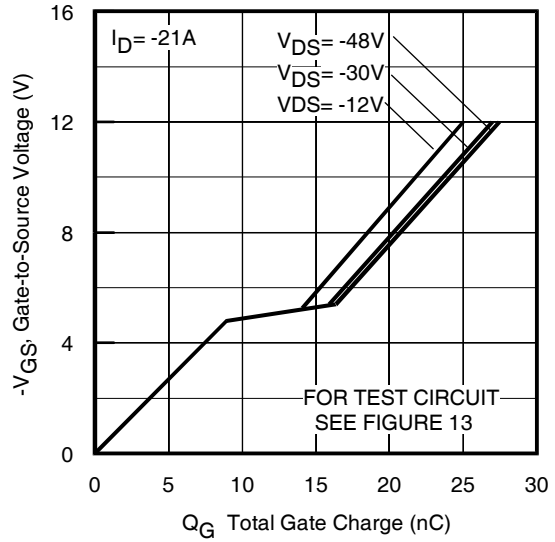

Fig 6. Typical Gate Charge Vs. Gate-to-Source Voltage

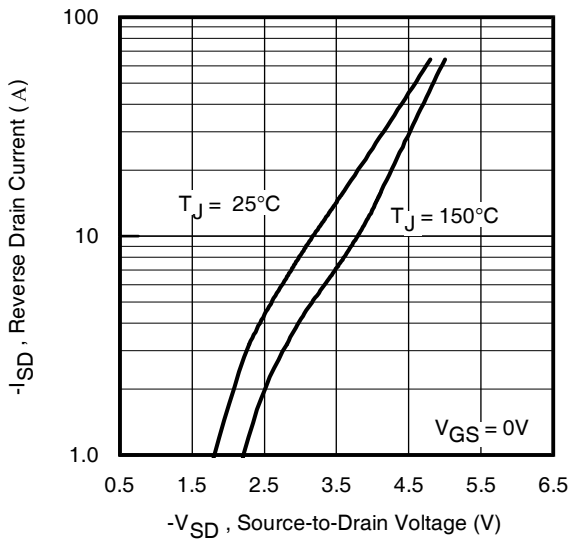

Fig 7. Typical Source-Drain Diode Forward Voltage

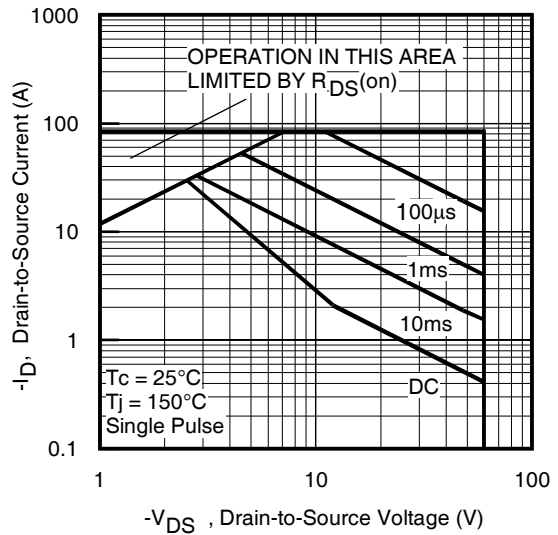

Fig 8. Maximum Safe Operating Area

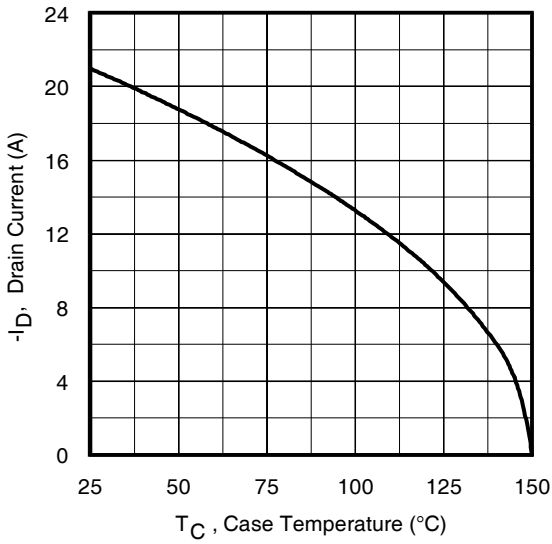

Fig 9. Maximum Drain Current Vs. Case Temperature

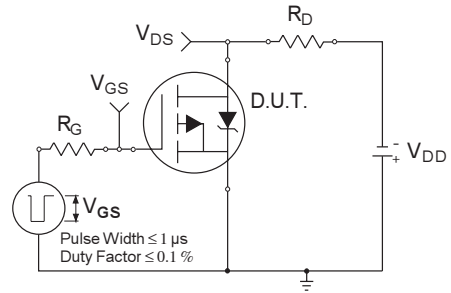

Fig 10a. Switching Time Test Circuit

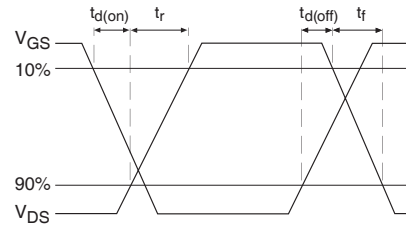

Fig 10b. Switching Time Waveforms

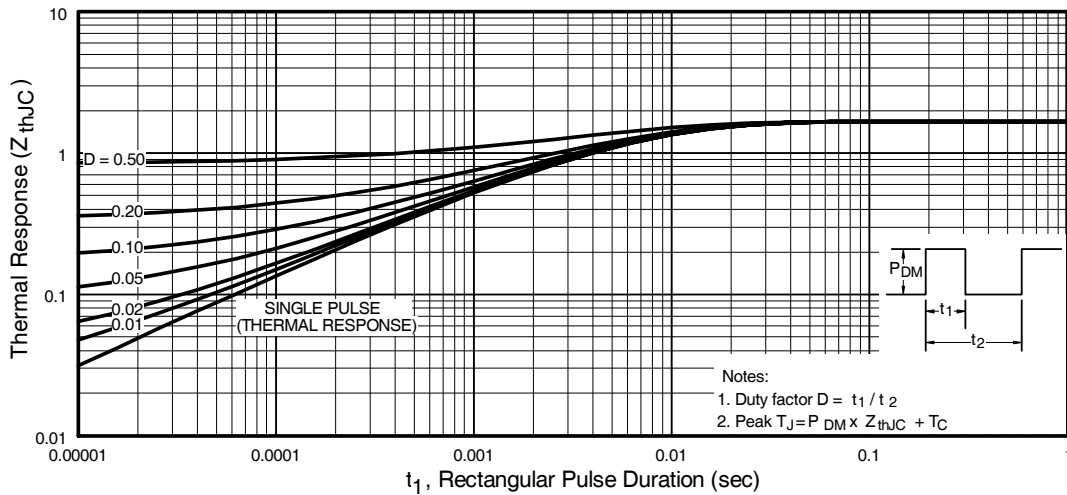

Fig 11. Maximum Effective Transient Thermal Impedance, Junction-to-Case

Pre-Irradiation

IRHNJ597034, JANSR2N7520U3

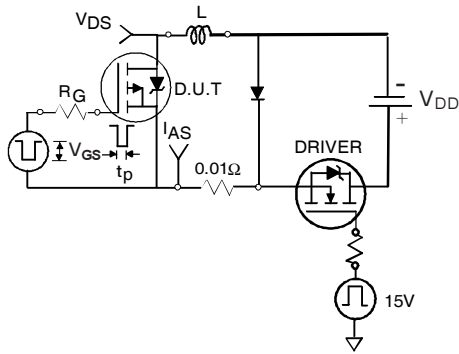

Fig 12a. Unclamped Inductive Test Circuit

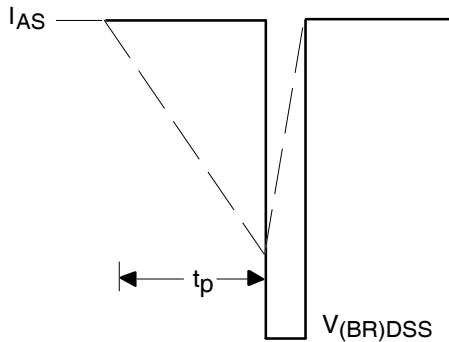

Fig 12b. Unclamped Inductive Waveforms

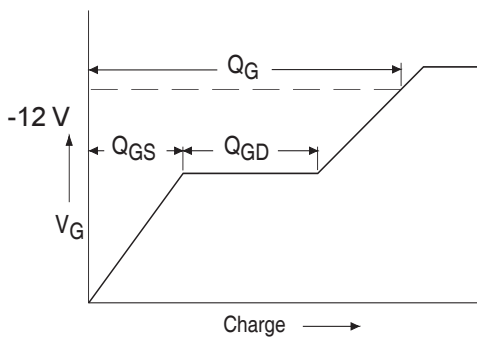

Fig 13a. Basic Gate Charge Waveform

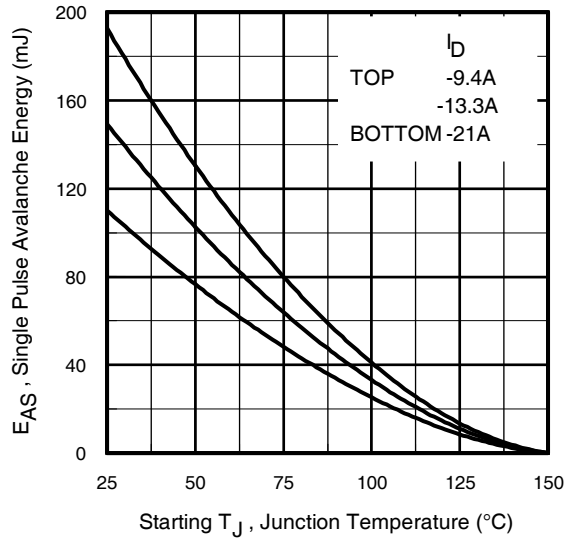

Fig 12c. Maximum Avalanche Energy Vs. Drain Current

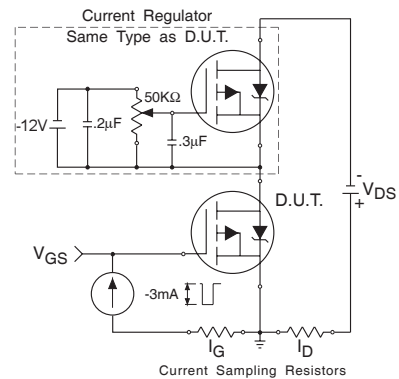



Fig 13b. Gate Charge Test Circuit

Footnotes:

- ① Repetitive Rating; Pulse width limited by maximum junction temperature.
- ② $V_{DD} = -25V$, starting $T_J = 25^\circ C$, $L = 0.5mH$
Peak $I_L = -21A$, $V_{GS} = -12V$
- ③ $I_{SD} \leq -21A$, $di/dt \leq -435A/\mu s$,
 $V_{DD} \leq -60V$, $T_J \leq 150^\circ C$
- ④ Pulse width $\leq 300 \mu s$; Duty Cycle $\leq 2\%$
- ⑤ **Total Dose Irradiation with V_{GS} Bias.**
-12 volt V_{GS} applied and $V_{DS} = 0$ during irradiation per MIL-STD-750, method 1019, condition A.
- ⑥ **Total Dose Irradiation with V_{DS} Bias.**
-48 volt V_{DS} applied and $V_{GS} = 0$ during irradiation per MIL-STD-750, method 1019, condition A.

Additional Product Summary (continued from page 1 and 3)

Product Summary

Part Number	Radiation Level	$R_{DS(on)}$	I_D	QPL Part Number	
IRHNJC597034	100K Rads (Si)	0.085Ω	-21A	JANSR2N7520U3C	SMD-0.5 (CERAMIC LID)
IRHNJC593034	300K Rads (Si)	0.085Ω	-21A	JANSF2N7520U3C	

Case Outline and Dimensions — SMD-0.5 (Metal Lid)

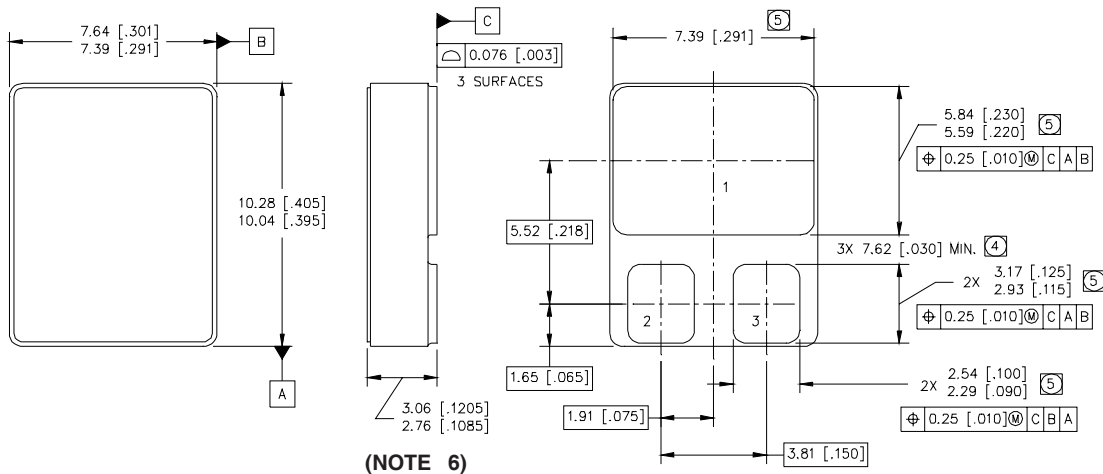

NOTES:

- 1. DIMENSIONING & TOLERANCING PER ASME Y14.5M-1994.
- 2. CONTROLLING DIMENSION: INCH.
- 3. DIMENSIONS ARE SHOWN IN MILLIMETERS [INCHES].
- ④ DIMENSION INCLUDES METALLIZATION FLASH.
- ⑤ DIMENSION DOES NOT INCLUDE METALLIZATION FLASH.

PAD ASSIGNMENTS

- 1 = DRAIN
- 2 = GATE
- 3 = SOURCE

- 6. For Ceramic Lid, all dimensions are the same, except overall thickness of Maximum 3.40 [.134]

International
IR Rectifier

IR WORLD HEADQUARTERS: 101 N Sepulveda Blvd., El Segundo, California 90245, USA Tel: (310) 252-7105
IR LEOMINSTER : 205 Crawford St., Leominster, Massachusetts 01453, USA Tel: (978) 534-5776
TAC Fax: (310) 252-7903

Visit us at www.irf.com for sales contact information.
Data and specifications subject to change without notice. 02/2015

单击下面可查看定价，库存，交付和生命周期等信息

[>>Infineon Technologies\(英飞凌\)](#)