

# MOSFET

## CoolSiC™ MOSFET 650 V G2

Built on Infineon's robust 2<sup>nd</sup> generation Silicon Carbide trench technology, the 650 V CoolSiC™ MOSFET delivers unparalleled performance, superior reliability, and great ease of use. It enables cost effective, highly efficient, and simplified designs to fulfill the ever-growing system and market needs.

### Features

- Ultra-low switching losses
- Benchmark gate threshold voltage,  $V_{GS(th)} = 4.5\text{ V}$
- Robust against parasitic turn-on even with 0 V turn-off gate voltage
- Flexible driving voltage and compatible with bipolar driving scheme
- Robust body diode operation under hard commutation events
- .XT interconnection technology for best-in-class thermal performance

### Benefits

- Enables high efficiency and high power density designs
- Facilitates great ease of use and integration
- Provides the best price performance ratio compared to Industry's most ambitious roadmaps
- Reduces the size, weight and bill of materials of the systems
- Enhances system robustness and reliability

### Potential applications

- SMPS
- Solar PV inverters
- Energy storage and battery formation
- UPS
- EV charging infrastructure
- Motor drives

### Product validation

Fully qualified according to JEDEC for Industrial Applications

**Table 1 Key Performance Parameters**

Parameter	Value	Unit
$V_{DSS}$ over full $T_{j,range}$	650	V
$R_{DS(on),typ}$	14.5	mΩ
$R_{DS(on),max}$	18	mΩ
$Q_{G,typ}$	79	nC
$I_{D,pulse}$	393	A
$Q_{oss} @ 400\text{ V}$	148	nC
$E_{oss} @ 400\text{ V}$	20.1	μJ

Type / Ordering Code	Package	Marking	Related Links
IMW65R015M2H	PG-TO247-3	65R015M2	see Appendix A

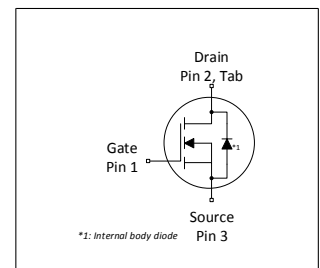
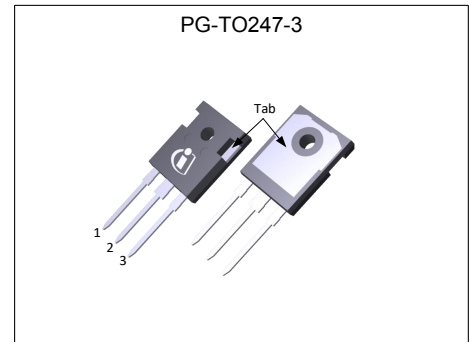

RoHS



**Table of Contents**

Description .....	1
Maximum ratings .....	3
Thermal characteristics .....	4
Operating range .....	4
Electrical characteristics .....	5
Electrical characteristics diagrams .....	8
Test Circuits .....	13
Package Outlines .....	14
Appendix A .....	15
Revision History .....	16
Trademarks .....	16
Disclaimer .....	16

## 1 Maximum ratings

at  $T_j = 25\text{ °C}$ , unless otherwise specified.

Note: for optimum lifetime and reliability, Infineon recommends operating conditions that do not exceed 80% of the maximum ratings stated in this datasheet.

**Table 2 Maximum ratings**

Parameter	Symbol	Values			Unit	Note / Test Condition
		Min.	Typ.	Max.		
Continuous DC drain current <sup>1)</sup>	$I_{\text{DDC}}$	-	-	93 75	A	$T_C = 25\text{ °C}$ $T_C = 100\text{ °C}$
Peak drain current <sup>2)</sup>	$I_{\text{DM}}$	-	-	393	A	$T_C = 25\text{ °C}$ , $V_{\text{GS}} = 18\text{ V}$
Avalanche energy, single pulse	$E_{\text{AS}}$	-	-	372	mJ	$I_{\text{D}} = 13.9\text{ A}$ , $V_{\text{DD}} = 50\text{ V}$ ; see table 11
Avalanche energy, repetitive	$E_{\text{AR}}$	-	-	1.86	mJ	$I_{\text{D}} = 13.9\text{ A}$ , $V_{\text{DD}} = 50\text{ V}$ ; see table 11
Avalanche current, single pulse	$I_{\text{AS}}$	-	-	13.9	A	-
MOSFET $dv/dt$ ruggedness	$dv/dt$	-	-	200	V/ns	$V_{\text{DS}} = 0\text{...}400\text{ V}$
Gate source voltage (static) <sup>3)</sup>	$V_{\text{GS}}$	-7	-	23	V	-
Gate source voltage (transient)	$V_{\text{GS}}$	-10	-	25	V	$t_p \leq 500\text{ ns}$ , duty cycle $\leq 1\%$
Power dissipation	$P_{\text{tot}}$	-	-	341	W	$T_C = 25\text{ °C}$
Storage temperature	$T_{\text{stg}}$	-55	-	150	°C	-
Operating junction temperature	$T_j$	-55	-	175	°C	-
Mounting torque	-	-	-	60	Ncm	M3 and M3.5 screws
Continuous reverse drain current <sup>1)</sup>	$I_{\text{SDC}}$	-	-	93 67	A	$V_{\text{GS}} = 18\text{ V}$ , $T_C = 25\text{ °C}$ $V_{\text{GS}} = 0\text{ V}$ , $T_C = 25\text{ °C}$
Peak reverse drain current <sup>2)</sup>	$I_{\text{SM}}$	-	-	393 121	A	$T_C = 25\text{ °C}$ , $t_p \leq 250\text{ ns}$ $T_C = 25\text{ °C}$
Insulation withstand voltage	$V_{\text{ISO}}$	-	-	n.a.	V	$V_{\text{rms}}$ , $T_C = 25\text{ °C}$ , $t = 1\text{ min}$

<sup>1)</sup> Limited by  $T_{\text{J,max}}$

<sup>2)</sup> Pulse width  $t_{\text{pulse}}$  limited by  $T_{\text{J,max}}$ .

<sup>3)</sup> The maximum gate-source voltage in the application design should be in accordance to IPC-9592B.

## 2 Thermal characteristics

**Table 3 Thermal characteristics**

Parameter	Symbol	Values			Unit	Note / Test Condition
		Min.	Typ.	Max.		
Thermal resistance, junction - case	$R_{th(j-c)}$	-	-	0.44	°C/W	Not subject to production test. Parameter verified by design/characterization according to JESD51-14.
Soldering temperature, wavesoldering only allowed at leads	$T_{sold}$	-	-	260	°C	1.6 mm (0.063 in.) from case for 10 s

## 3 Operating range

**Table 4 Operating range**

Parameter	Symbol	Values			Unit	Note / Test Condition
		Min.	Typ.	Max.		
Recommended turn-on voltage	$V_{GS(on)}$	-	18	-	V	-
Recommended turn-off voltage	$V_{GS(off)}$	-	0	-	V	-

## 4 Electrical characteristics

at  $T_j = 25\text{ °C}$ , unless otherwise specified

**Table 5 Static characteristics**

Parameter	Symbol	Values			Unit	Note / Test Condition
		Min.	Typ.	Max.		
Drain-source voltage	$V_{DSS}$	650	-	-	V	$V_{GS} = 0\text{ V}$ , $I_D = 1.30\text{ mA}$
Gate threshold voltage <sup>1)</sup>	$V_{GS(th)}$	3.5	4.5	5.6	V	$V_{DS} = V_{GS}$ , $I_D = 13.0\text{ mA}$
Zero gate voltage drain current	$I_{DSS}$	-	1 3	75 -	$\mu\text{A}$	$V_{DS} = 650\text{ V}$ , $V_{GS} = 0\text{ V}$ , $T_j = 25\text{ °C}$ $V_{DS} = 650\text{ V}$ , $V_{GS} = 0\text{ V}$ , $T_j = 175\text{ °C}$
Gate-source leakage current	$I_{GSS}$	-	-	100	nA	$V_{GS} = 20\text{ V}$ , $V_{DS} = 0\text{ V}$
Drain-source on-state resistance	$R_{DS(on)}$	-	18.9 14.5 13.2 23.7	- 18 -	$\text{m}\Omega$	$V_{GS} = 15\text{ V}$ , $I_D = 64.2\text{ A}$ , $T_j = 25\text{ °C}$ $V_{GS} = 18\text{ V}$ , $I_D = 64.2\text{ A}$ , $T_j = 25\text{ °C}$ $V_{GS} = 20\text{ V}$ , $I_D = 64.2\text{ A}$ , $T_j = 25\text{ °C}$ $V_{GS} = 18\text{ V}$ , $I_D = 64.2\text{ A}$ , $T_j = 175\text{ °C}$
Internal gate resistance	$R_{G,int}$	-	2.1	-	$\Omega$	$f = 1\text{ MHz}$

<sup>1)</sup> Tested after 1 ms pulse at  $V_{GS} = +20\text{ V}$ . "Linear mode" operation is not recommended. For assessment of potential "linear mode" operation, please contact Infineon sales office.

**Table 6 Dynamic characteristics**

External parasitic elements (PCB layout) influence switching behavior significantly.  
Stray inductances and coupling capacitances must be minimized.

For layout recommendations please use provided application notes or contact Infineon sales office.

Parameter	Symbol	Values			Unit	Note / Test Condition
		Min.	Typ.	Max.		
Input capacitance	$C_{iss}$	-	2792	-	pF	$V_{GS} = 0\text{ V}$ , $V_{DS} = 400\text{ V}$ , $f = 250\text{ kHz}$
Reverse transfer capacitance	$C_{rss}$	-	16	-	pF	$V_{GS} = 0\text{ V}$ , $V_{DS} = 400\text{ V}$ , $f = 250\text{ kHz}$
Output capacitance <sup>1)</sup>	$C_{oss}$	-	207	269	pF	$V_{GS} = 0\text{ V}$ , $V_{DS} = 400\text{ V}$ , $f = 250\text{ kHz}$
Output charge <sup>1)</sup>	$Q_{oss}$	-	148	193	nC	calculation based on $C_{oss}$
Effective output capacitance, energy related <sup>2)</sup>	$C_{o(er)}$	-	251	-	pF	$V_{GS} = 0\text{ V}$ , $V_{DS} = 0...400\text{ V}$
Effective output capacitance, time related <sup>3)</sup>	$C_{o(tr)}$	-	371	-	pF	$I_D = \text{constant}$ , $V_{GS} = 0\text{ V}$ , $V_{DS} = 0...400\text{ V}$
Turn-on delay time	$t_{d(on)}$	-	34	-	ns	$V_{DD} = 400\text{ V}$ , $V_{GS} = 0/18\text{ V}$ , $I_D = 64.2\text{ A}$ , $R_{G,ext} = 1.8\ \Omega$ ; see table 10
Rise time	$t_r$	-	21	-	ns	$V_{DD} = 400\text{ V}$ , $V_{GS} = 0/18\text{ V}$ , $I_D = 64.2\text{ A}$ , $R_{G,ext} = 1.8\ \Omega$ ; see table 10
Turn-off delay time	$t_{d(off)}$	-	22	-	ns	$V_{DD} = 400\text{ V}$ , $V_{GS} = 0/18\text{ V}$ , $I_D = 64.2\text{ A}$ , $R_{G,ext} = 1.8\ \Omega$ ; see table 10
Fall time	$t_f$	-	8.0	-	ns	$V_{DD} = 400\text{ V}$ , $V_{GS} = 0/18\text{ V}$ , $I_D = 64.2\text{ A}$ , $R_{G,ext} = 1.8\ \Omega$ ; see table 10
Turn-ON switching losses <sup>4)</sup>	$E_{on}$	-	825	-	$\mu\text{J}$	$V_{DD} = 400\text{ V}$ , $V_{GS} = 0/18\text{ V}$ , $I_D = 64.2\text{ A}$ , $R_{G,ext} = 1.8\ \Omega$
Turn-OFF switching losses <sup>4)</sup>	$E_{off}$	-	191	-	$\mu\text{J}$	$V_{DD} = 400\text{ V}$ , $V_{GS} = 0/18\text{ V}$ , $I_D = 64.2\text{ A}$ , $R_{G,ext} = 1.8\ \Omega$
Total switching losses <sup>4)</sup>	$E_{tot}$	-	1016	-	$\mu\text{J}$	$V_{DD} = 400\text{ V}$ , $V_{GS} = 0/18\text{ V}$ , $I_D = 64.2\text{ A}$ , $R_{G,ext} = 1.8\ \Omega$

**Table 7 Gate charge characteristics**

Parameter	Symbol	Values			Unit	Note / Test Condition
		Min.	Typ.	Max.		
Plateau gate to source charge	$Q_{GS(pl)}$	-	21	-	nC	$V_{DD} = 400\text{ V}$ , $I_D = 64.2\text{ A}$ , $V_{GS} = 0\text{ to }18\text{ V}$
Gate to drain charge	$Q_{GD}$	-	15	-	nC	$V_{DD} = 400\text{ V}$ , $I_D = 64.2\text{ A}$ , $V_{GS} = 0\text{ to }18\text{ V}$
Total gate charge	$Q_G$	-	79	-	nC	$V_{DD} = 400\text{ V}$ , $I_D = 64.2\text{ A}$ , $V_{GS} = 0\text{ to }18\text{ V}$

<sup>1)</sup> Maximum specification is defined by calculated six sigma upper confidence bound

<sup>2)</sup>  $C_{o(er)}$  is a fixed capacitance that gives the same stored energy as  $C_{oss}$  while  $V_{DS}$  is rising from 0 to 400 V.

<sup>3)</sup>  $C_{o(tr)}$  is a fixed capacitance that gives the same charging time as  $C_{oss}$  while  $V_{DS}$  is rising from 0 to 400 V.

<sup>4)</sup> MOSFET used in half-bridge configuration without external diode

**Table 8 Reverse diode characteristics**

Parameter	Symbol	Values			Unit	Note / Test Condition
		Min.	Typ.	Max.		
Drain-source reverse voltage	$V_{SD}$	-	4.4	-	V	$V_{GS} = 0\text{ V}$ , $I_S = 64.2\text{ A}$ , $T_J = 25\text{ °C}$
MOSFET forward recovery time	$t_{fr}$	-	40.5	-	ns	$V_{DD} = 400\text{ V}$ , $I_S = 64.2\text{ A}$ , $di_S/dt = 1000\text{ A}/\mu\text{s}$ ; see table 9
MOSFET forward recovery charge <sup>1)</sup>	$Q_{fr}$	-	221	-	nC	$V_{DD} = 400\text{ V}$ , $I_S = 64.2\text{ A}$ , $di_S/dt = 1000\text{ A}/\mu\text{s}$ ; see table 9
MOSFET peak forward recovery current	$I_{frm}$	-	10.9	-	A	$V_{DD} = 400\text{ V}$ , $I_S = 64.2\text{ A}$ , $di_S/dt = 1000\text{ A}/\mu\text{s}$ ; see table 9

<sup>1)</sup>  $Q_{fr}$  includes  $Q_{oss}$

## 5 Electrical characteristics diagrams

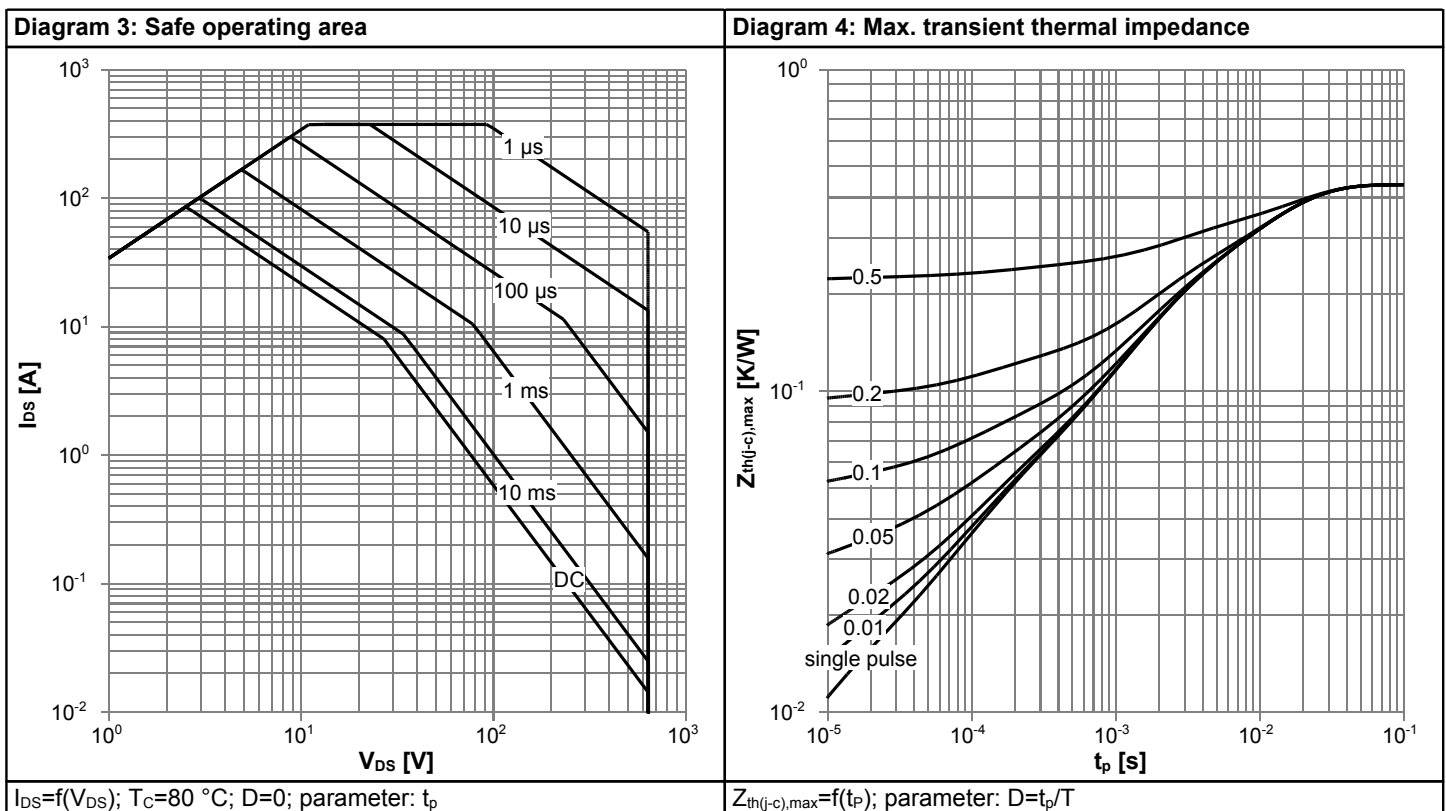
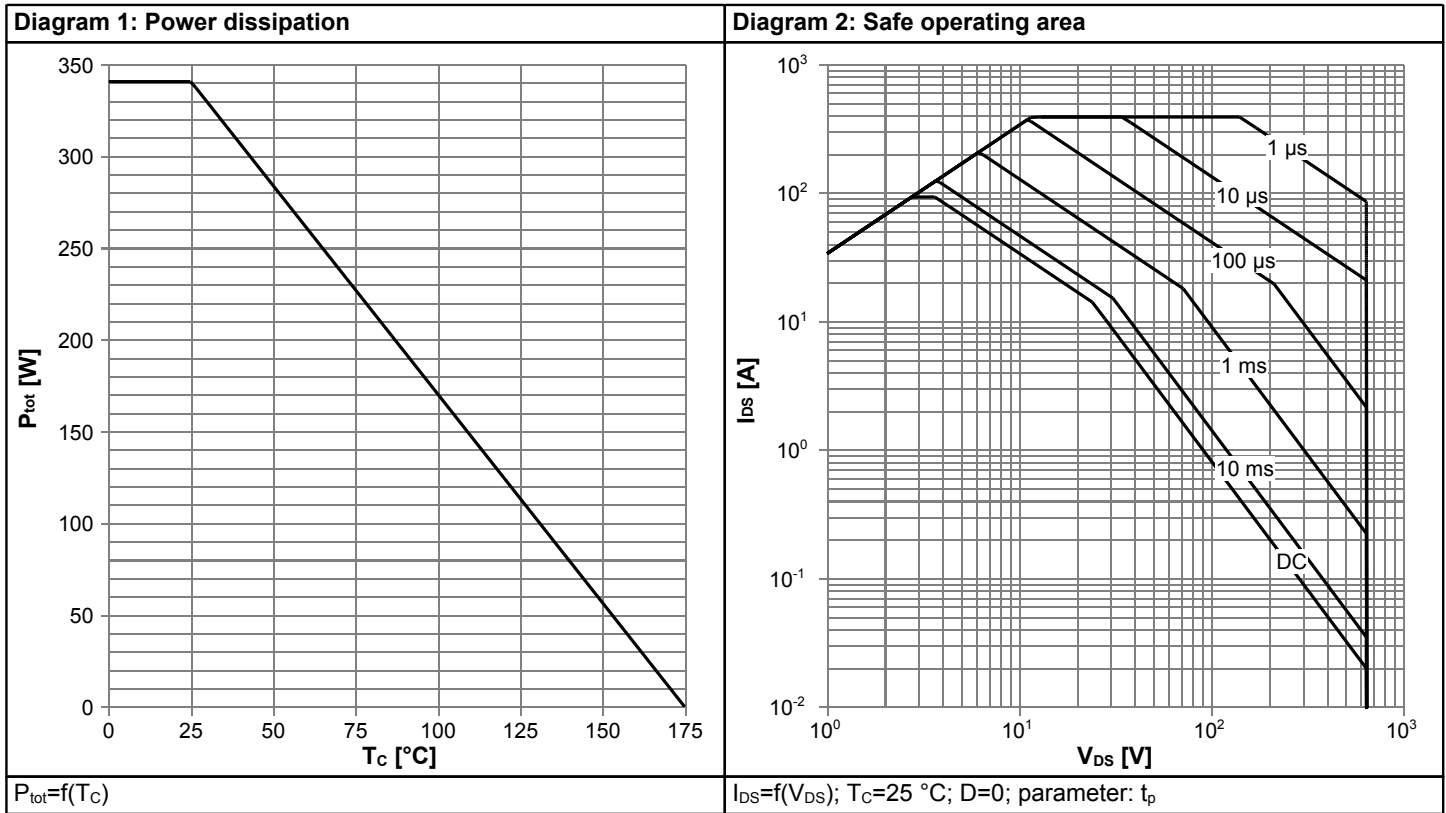
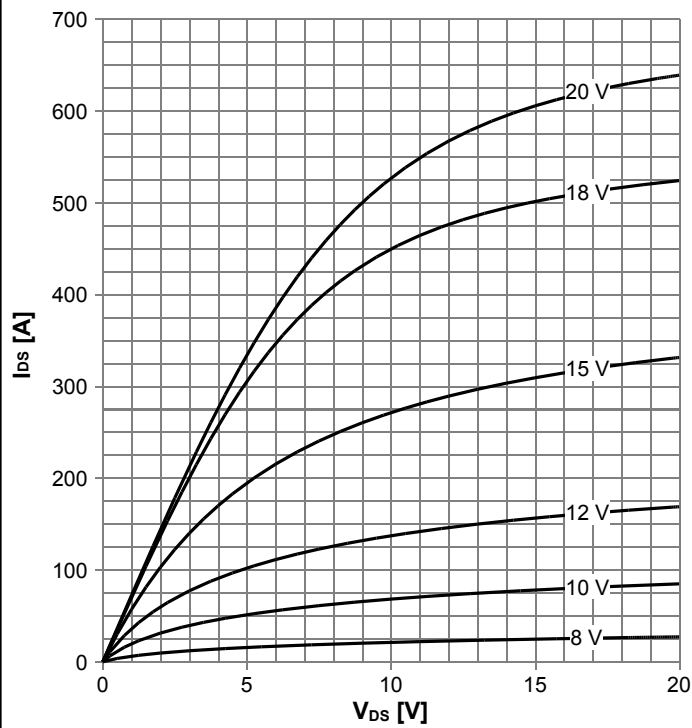

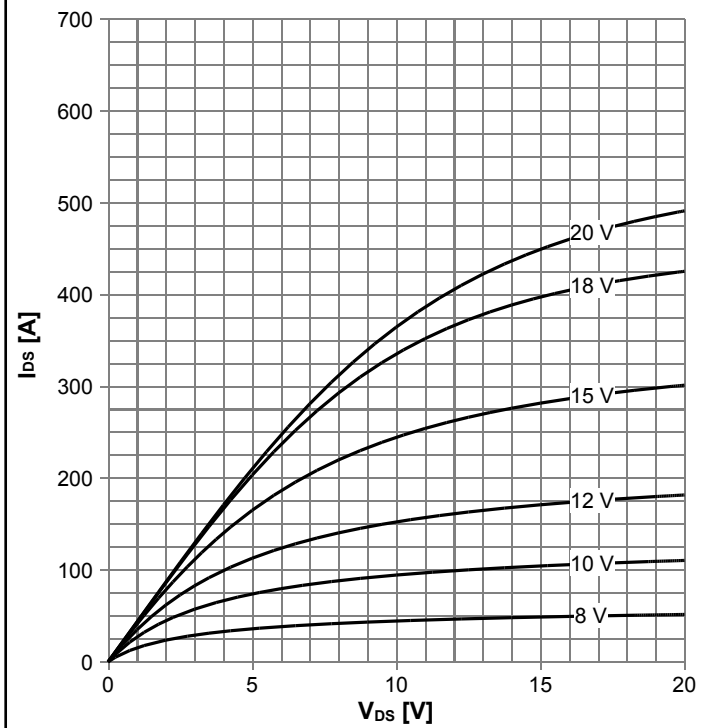

Diagram 5: Typ. output characteristics



$I_{DS}=f(V_{DS}); T_j=25\text{ °C}; \text{parameter: } V_{GS}$

Diagram 6: Typ. output characteristics



$I_{DS}=f(V_{DS}); T_j=175\text{ °C}; \text{parameter: } V_{GS}$

Diagram 7: Typ. drain-source on-state resistance

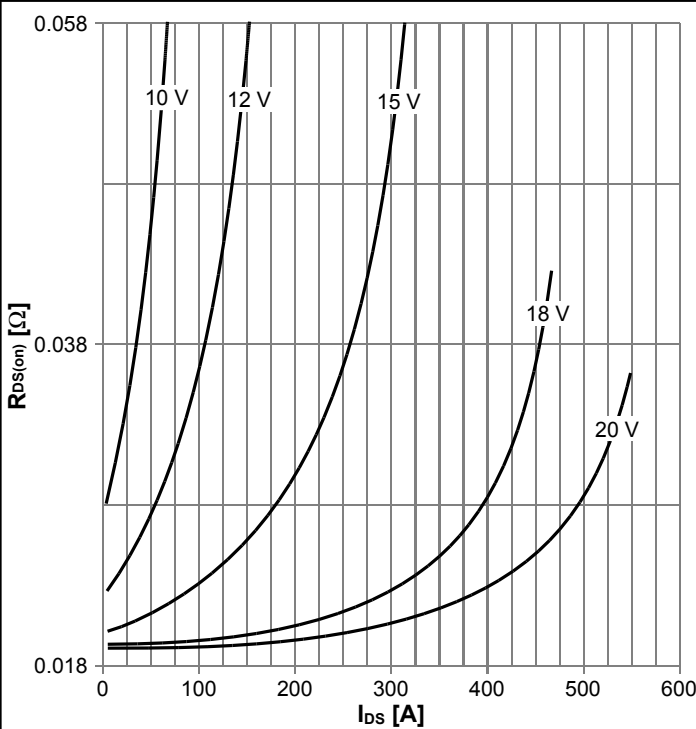

$R_{DS(on)}=f(I_{DS}); T_j=125\text{ °C}; \text{parameter: } V_{GS}$

Diagram 8: Drain-source on-state resistance

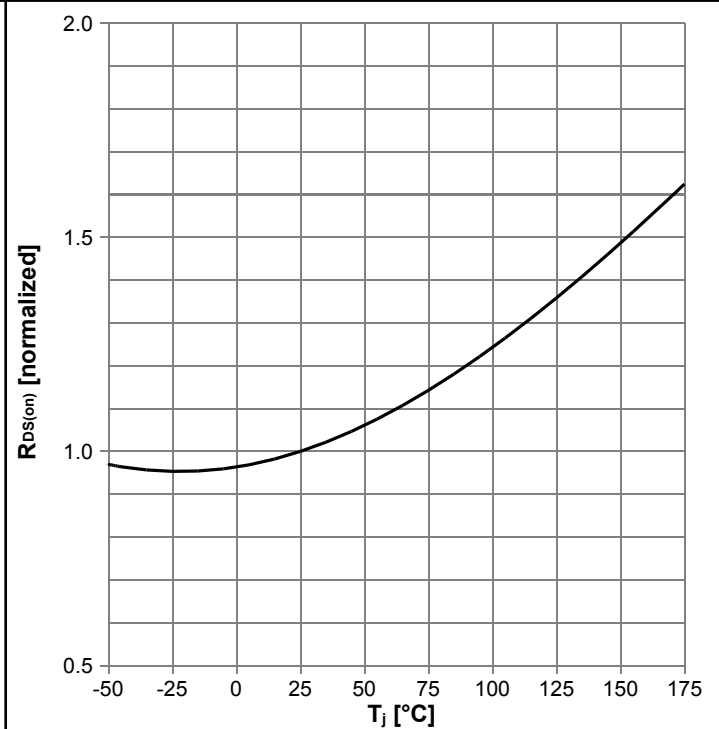

$R_{DS(on)}=f(T_j); I_D=64.2\text{ A}; V_{GS}=18\text{ V}$

Diagram 9: Typ. transfer characteristics

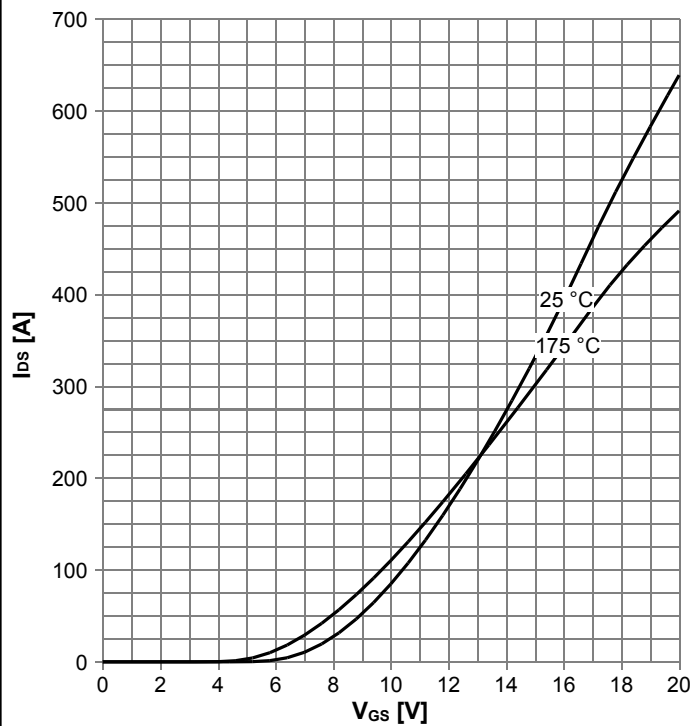

$I_{DS}=f(V_{GS})$ ;  $V_{DS}=20$  V; parameter:  $T_j$

Diagram 10: Typ. gate charge

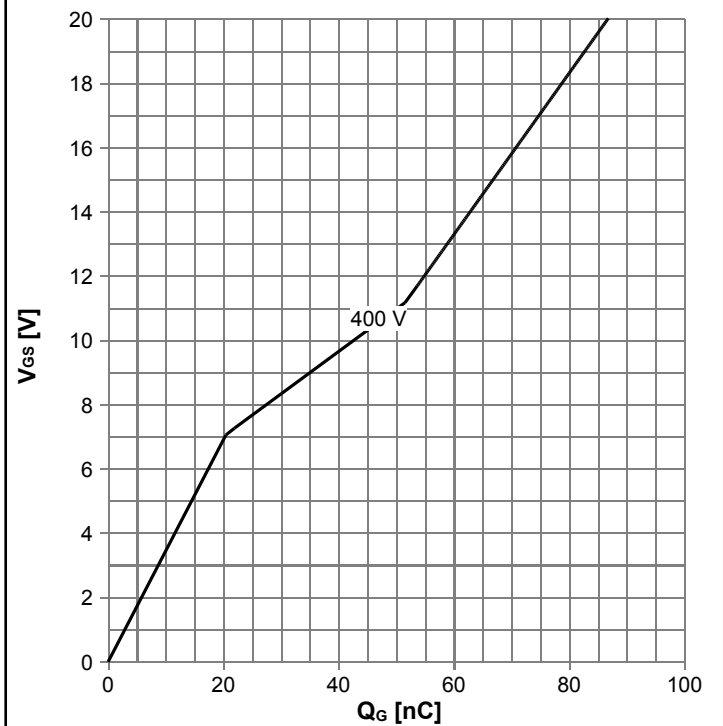

$V_{GS}=f(Q_G)$ ;  $I_D=64.2$  A pulsed; parameter:  $V_{DD}$

Diagram 11: Typ. reverse drain current characteristics

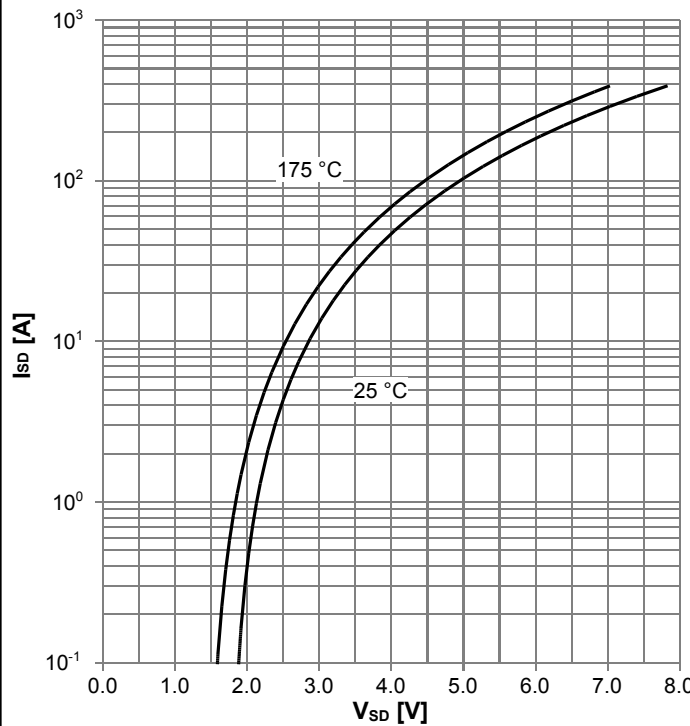

$I_{SD}=f(V_{SD})$ ;  $V_{GS}=0$  V; parameter:  $T_j$

Diagram 12: Typ. reverse drain current characteristics

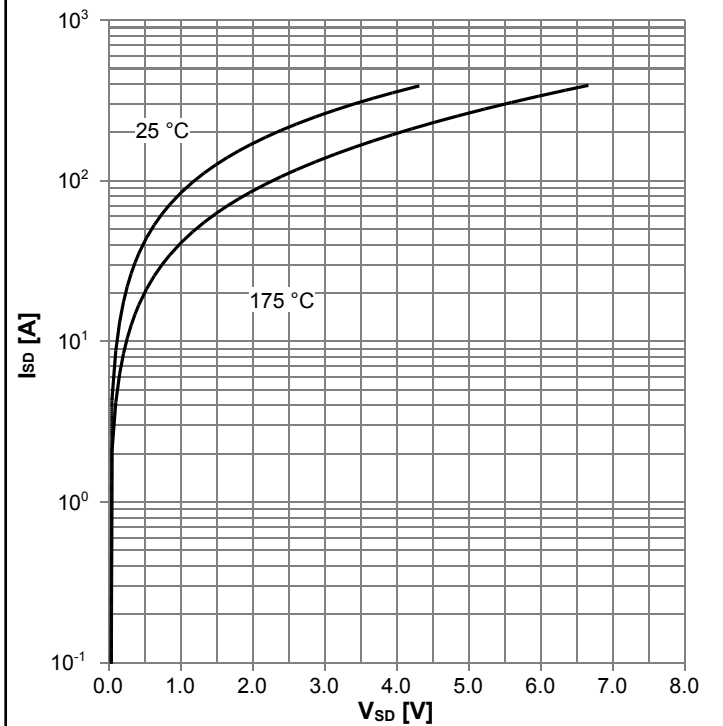

$I_{SD}=f(V_{SD})$ ;  $V_{GS}=18$  V; parameter:  $T_j$

Diagram 13: Avalanche energy

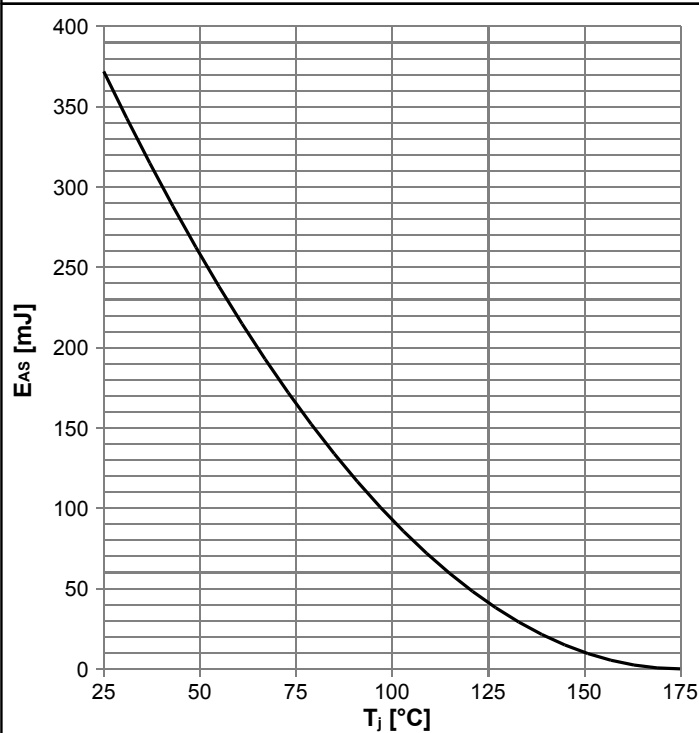

$E_{AS}=f(T_j)$ ;  $I_D=13.9$  A;  $V_{DD}=50$  V

Diagram 14: Drain-source breakdown voltage

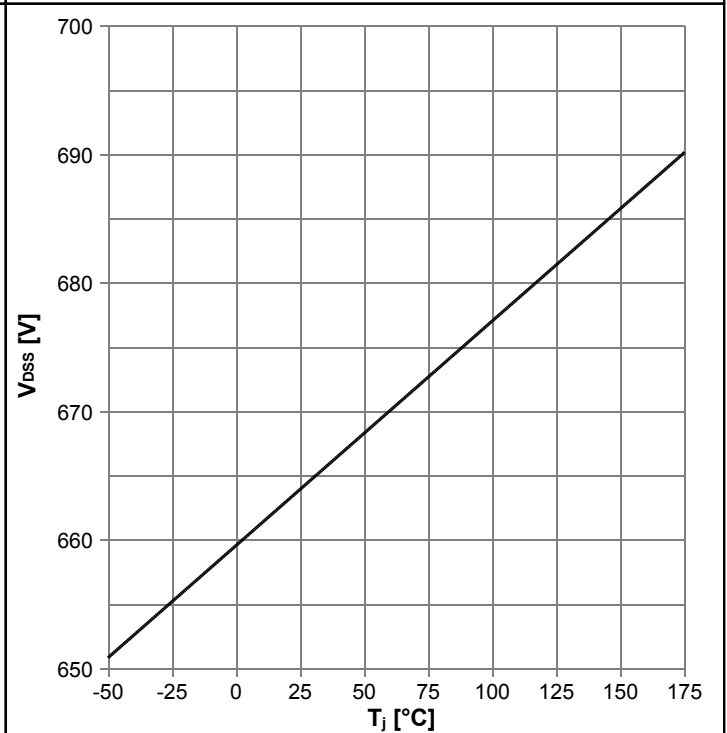

$V_{DSS}=f(T_j)$ ;  $I_D=1.3$  mA

Diagram 15: Typ. capacitances

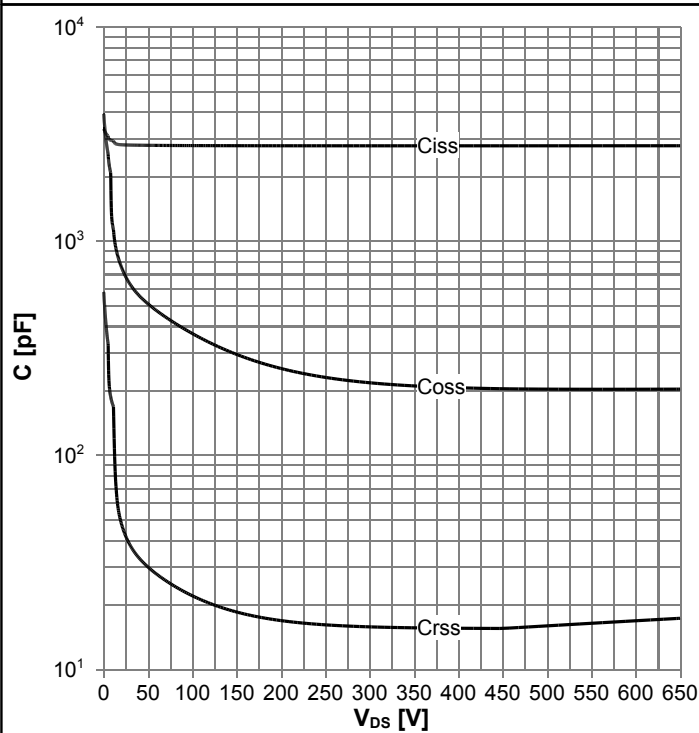

$C=f(V_{DS})$ ;  $V_{GS}=0$  V;  $f=250$  kHz

Diagram 16: Typ. Coss stored energy

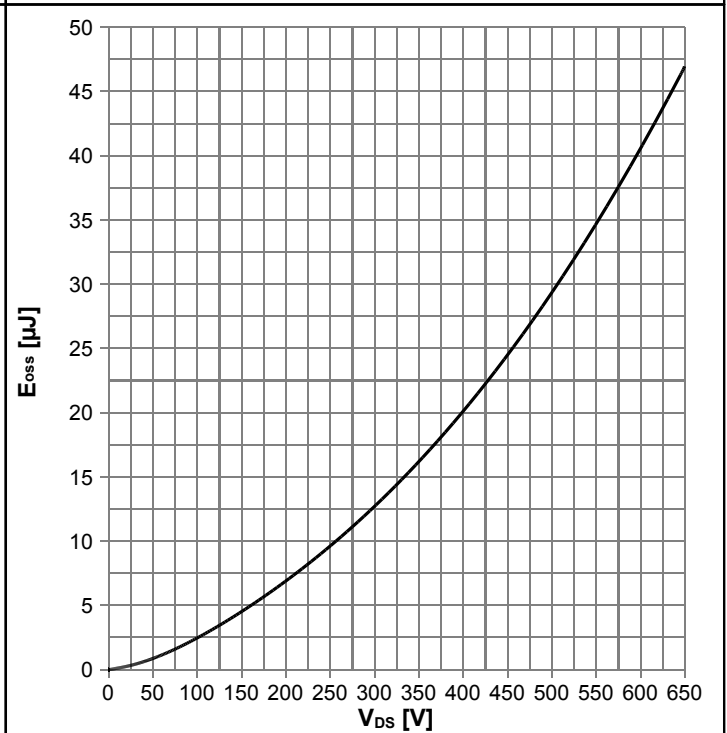

$E_{oss}=f(V_{DS})$

Diagram 17: Typ. Qoss output charge

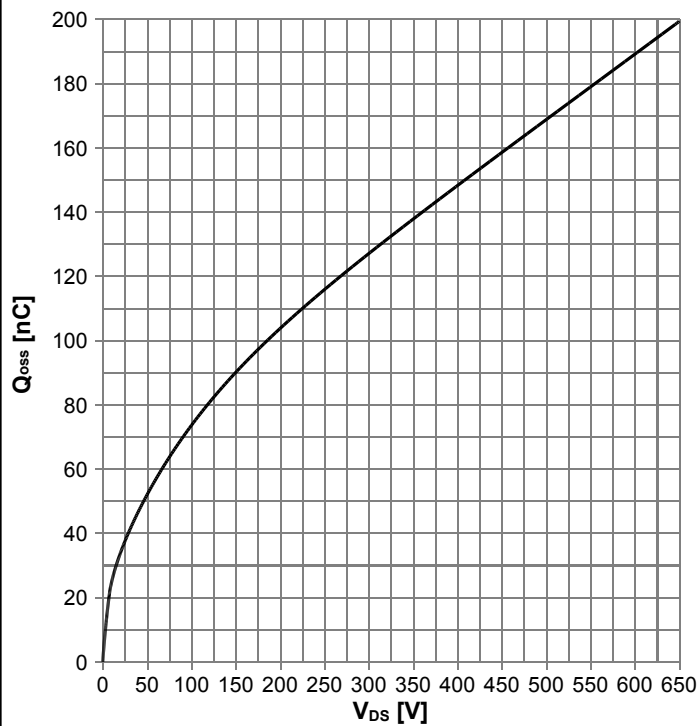

$Q_{oss}=f(V_{DS})$

Diagram 18: Typ. Switching Losses vs  $R_{G,ext}$

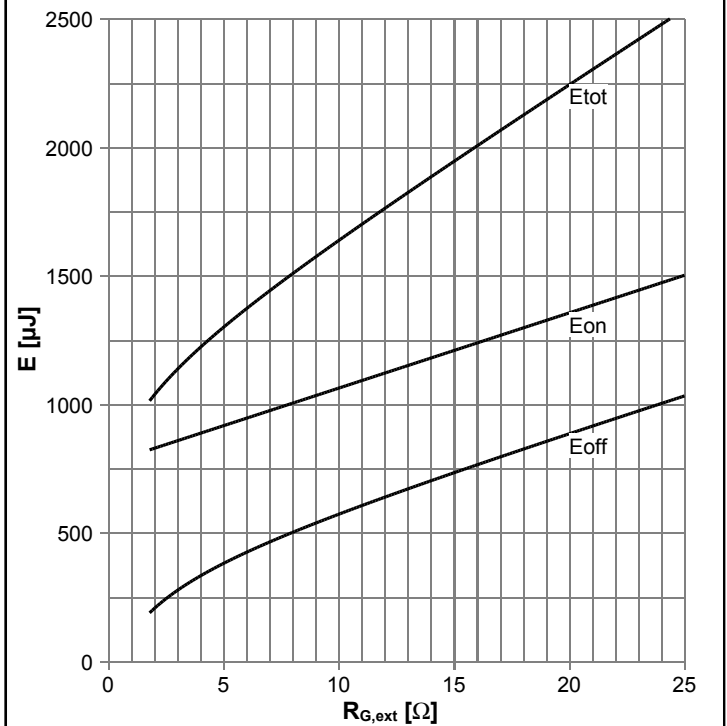

$E=f(R_{G,ext}); V_{DD}=400\text{ V}; V_{GS}=0/18\text{ V}; I_D=64.3\text{ A}$

Diagram 19: Typ. Switching Losses vs switching current

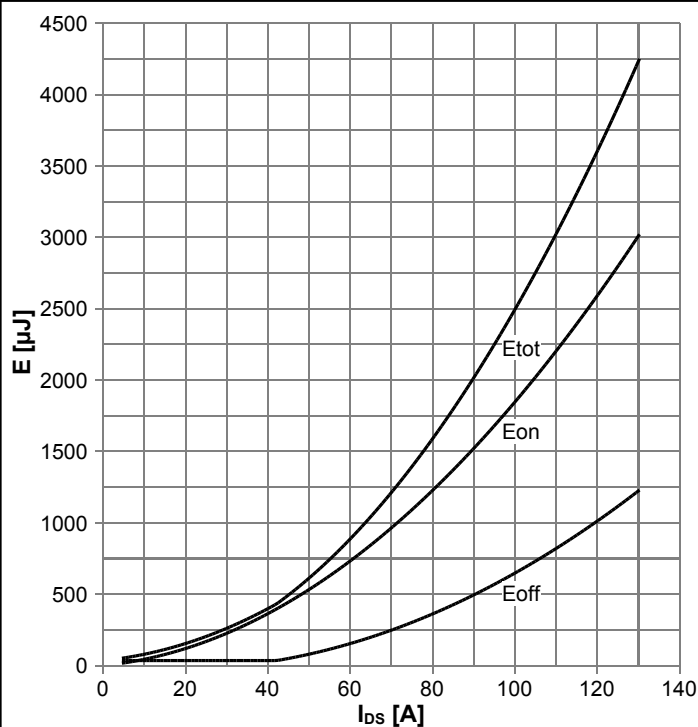

$E=f(I_{DS}); V_{DD}=400\text{ V}; V_{GS}=0/18\text{ V}; R_{G,ext}=1.8\ \Omega$

## 6 Test Circuits

**Table 9 Body diode characteristics**

Test circuit for body diode characteristics	Body diode recovery waveform

**Table 10 Switching times**

Switching times test circuit for inductive load	Switching times waveform

**Table 11 Unclamped inductive load**

Unclamped inductive load test circuit	Unclamped inductive waveform

## 7 Package Outlines

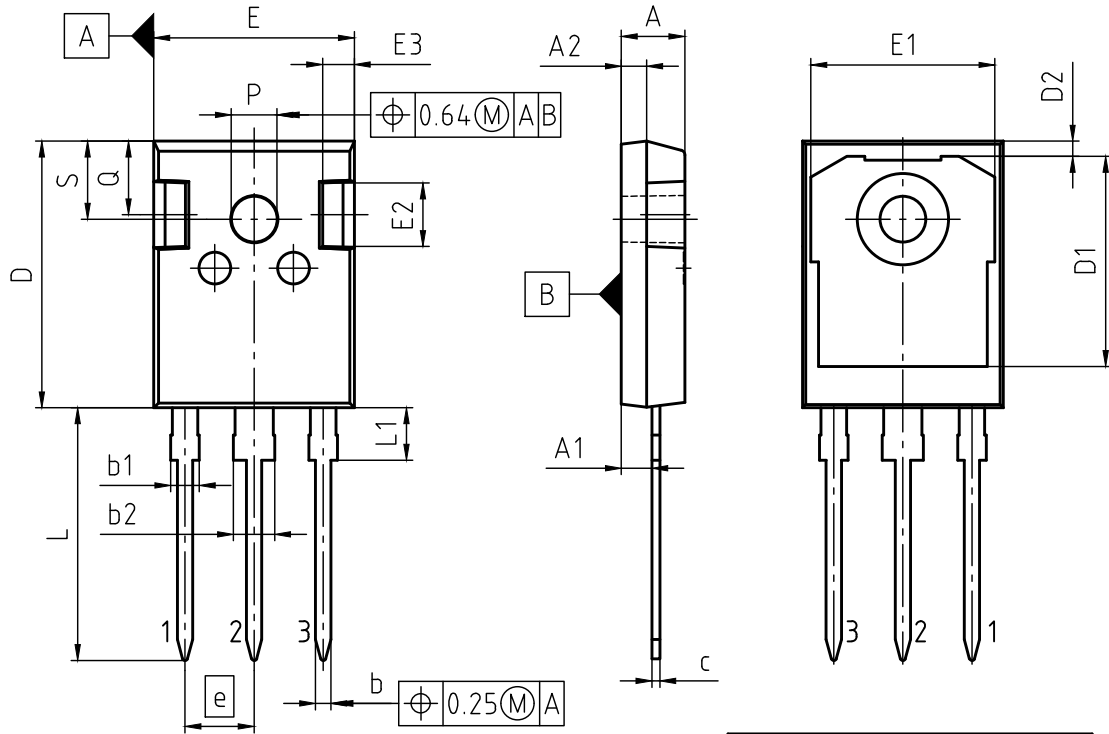

PACKAGE - GROUP NUMBER: PG-TO247-3-U06		
DIMENSIONS	MILLIMETERS	
	MIN.	MAX.
A	4.83	5.21
A1	2.27	2.54
A2	1.85	2.16
b	1.07	1.33
b1	1.90	2.41
b2	2.87	3.38
c	0.55	0.68
D	20.80	21.10
D1	16.25	17.65
D2	0.95	1.35
E	15.70	16.13
E1	13.10	14.15
E2	3.68	5.10
E3	1.00	2.60
e	5.44	
N	3	
L	19.80	20.32
L1	4.10	4.47
$\phi P$	3.50	3.70
Q	5.49	6.00
S	6.04	6.30

NOTE:  
DIMENSIONS DO NOT INCLUDE MOLDFLASH; PROTRUSION OR GATE BURRS

Figure 1 Outline PG-TO247-3, dimensions in mm

## 8 Appendix A

### Table 12 Related Links

- IFX CoolSiC CoolSiC™ MOSFET 650 V G2 Webpage: [www.infineon.com](http://www.infineon.com)
- IFX CoolSiC CoolSiC™ MOSFET 650 V G2 application note: [www.infineon.com](http://www.infineon.com)
- IFX CoolSiC CoolSiC™ MOSFET 650 V G2 simulation model: [www.infineon.com](http://www.infineon.com)
- IFX Design tools: [www.infineon.com](http://www.infineon.com)

## Revision History

IMW65R015M2H

**Revision: 2024-03-05, Rev. 2.2**

Previous Revision

Revision	Date	Subjects (major changes since last revision)
2.0	2023-11-02	Release of final version
2.1	2024-02-29	updated simulation model; included Eon and Eoff data and diagrams
2.2	2024-03-05	minor layout changes

### Trademarks

All referenced product or service names and trademarks are the property of their respective owners.

### We Listen to Your Comments

Any information within this document that you feel is wrong, unclear or missing at all? Your feedback will help us to continuously improve the quality of this document. Please send your proposal (including a reference to this document) to:

[erratum@infineon.com](mailto:erratum@infineon.com)

### Published by

**Infineon Technologies AG**

**81726 München, Germany**

**© 2023 Infineon Technologies AG**

**All Rights Reserved.**

### Legal Disclaimer

The information given in this document shall in no event be regarded as a guarantee of conditions or characteristics ("Beschaffheitsgarantie").

With respect to any examples, hints or any typical values stated herein and/or any information regarding the application of the product, Infineon Technologies hereby disclaims any and all warranties and liabilities of any kind, including without limitation warranties of non-infringement of intellectual property rights of any third party.

In addition, any information given in this document is subject to customer's compliance with its obligations stated in this document and any applicable legal requirements, norms and standards concerning customer's products and any use of the product of Infineon Technologies in customer's applications.

The data contained in this document is exclusively intended for technically trained staff. It is the responsibility of customer's technical departments to evaluate the suitability of the product for the intended application and the completeness of the product information given in this document with respect to such application.

### Information

For further information on technology, delivery terms and conditions and prices please contact your nearest Infineon Technologies Office ([www.infineon.com](http://www.infineon.com)).

### Warnings

Due to technical requirements, components may contain dangerous substances. For information on the types in question, please contact the nearest Infineon Technologies Office.

The Infineon Technologies component described in this Data Sheet may be used in life-support devices or systems and/or automotive, aviation and aerospace applications or systems only with the express written approval of Infineon Technologies, if a failure of such components can reasonably be expected to cause the failure of that life-support, automotive, aviation and aerospace device or system or to affect the safety or effectiveness of that device or system. Life support devices or systems are intended to be implanted in the human body or to support and/or maintain and sustain and/or protect human life. If they fail, it is reasonable to assume that the health of the user or other persons may be endangered.



单击下面可查看定价，库存，交付和生命周期等信息

[>>Infineon\(英飞凌\)](#)