

IRGP4072DPbF

INSULATED GATE BIPOLAR TRANSISTOR WITH ULTRAFAST SOFT RECOVERY DIODE

Features

- Low $V_{CE(ON)}$ Trench IGBT Technology
- Low switching losses
- Maximum Junction temperature 150 °C
- Square RBSOA
- 100% of the parts tested for clamped inductive load
- Ultra fast soft Recovery Co-Pak Diode
- Tight parameter distribution
- Lead Free Package

Benefits

- High Efficiency in a wide range of applications
- Suitable for a wide range of switching frequencies due to Low $V_{CE(ON)}$ and Low Switching losses
- Rugged transient Performance for increased reliability
- Low EMI

Applications

- Uninterruptible Power Supplies
- Battery operated vehicles
- Welding
- Solar converters and inverters

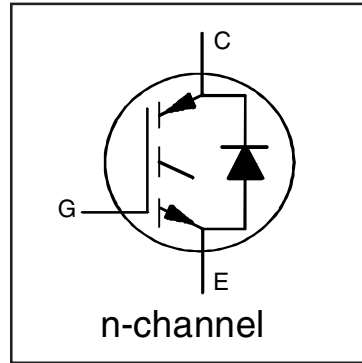

$V_{CES} = 300V$
$I_C = 40A, T_C = 100^\circ C$
$V_{CE(on)} \text{ typ.} = 1.46V$

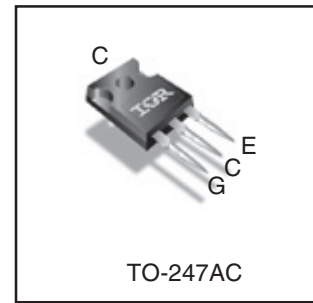

G	C	E
Gate	Collector	Emitter

Absolute Maximum Ratings

	Parameter	Max.	Units
V_{CES}	Collector-to-Emitter Voltage	300	V
$I_C @ T_C = 25^\circ C$	Continuous Collector Current	70	A
$I_C @ T_C = 100^\circ C$	Continuous Collector Current	40	
I_{CM}	Pulse Collector Current	120	
I_{LM}	Clamped Inductive Load Current ①	120	
$I_F @ T_C = 25^\circ C$	Diode Continuous Forward Current	70	
$I_F @ T_C = 100^\circ C$	Diode Continuous Forward Current	40	
I_{FM}	Diode Maximum Forward Current ③	120	
V_{GE}	Continuous Gate-to-Emitter Voltage	± 20	V
	Transient Gate-to-Emitter Voltage	± 30	
$P_D @ T_C = 25^\circ C$	Maximum Power Dissipation	180	W
		$P_D @ T_C = 100^\circ C$	
T_J T_{STG}	Operating Junction and Storage Temperature Range	-55 to +150	°C
	Soldering Temperature, for 10 sec.	300 (0.063 in. (1.6mm) from case)	
	Mounting Torque, 6-32 or M3 Screw	10 lbf-in (1.1 N-m)	

Thermal Resistance

	Parameter	Min.	Typ.	Max.	Units
$R_{\theta JC}$ (IGBT)	Thermal Resistance Junction-to-Case-(each IGBT)	—	—	0.70	°C/W
$R_{\theta JC}$ (Diode)	Thermal Resistance Junction-to-Case-(each Diode)	—	—	0.87	
$R_{\theta CS}$	Thermal Resistance, Case-to-Sink (flat, greased surface)	—	0.24	—	
$R_{\theta JA}$	Thermal Resistance, Junction-to-Ambient (typical socket mount)	—	80	—	

Electrical Characteristics @ $T_J = 25^\circ\text{C}$ (unless otherwise specified)

	Parameter	Min.	Typ.	Max.	Units	Conditions	Ref.Fig
$V_{(BR)CES}$	Collector-to-Emitter Breakdown Voltage	300	—	—	V	$V_{GE} = 0V, I_C = 1.0mA$	
$\Delta V_{(BR)CES}/\Delta T_J$	Temperature Coeff. of Breakdown Voltage	—	0.20	—	V/ $^\circ\text{C}$	$V_{GE} = 0V, I_C = 1mA (25^\circ\text{C}-150^\circ\text{C})$	
$V_{CE(on)}$	Collector-to-Emitter Saturation Voltage	—	1.46	1.70	V	$I_C = 40A, V_{GE} = 15V, T_J = 25^\circ\text{C}$	5,6,7
		—	1.59	—		$I_C = 40A, V_{GE} = 15V, T_J = 150^\circ\text{C}$	9,10,11
$V_{GE(th)}$	Gate Threshold Voltage	2.6	—	5.0	V	$V_{CE} = V_{GE}, I_C = 500\mu A$	9, 10,
$\Delta V_{GE(th)}/\Delta T_J$	Threshold Voltage temp. coefficient	—	-13	—	mV/ $^\circ\text{C}$	$V_{CE} = V_{GE}, I_C = 1.0mA (25^\circ\text{C} - 150^\circ\text{C})$	11, 12
g_{fe}	Forward Transconductance	—	28	—	S	$V_{CE} = 25V, I_C = 40A$	
I_{CES}	Collector-to-Emitter Leakage Current	—	1.0	25	μA	$V_{GE} = 0V, V_{CE} = 300V$	
		—	450	—		$V_{GE} = 0V, V_{CE} = 300V, T_J = 150^\circ\text{C}$	
V_{FM}	Diode Forward Voltage Drop	—	2.26	2.69	V	$I_F = 40A$	8
		—	1.53	—		$I_F = 40A, T_J = 150^\circ\text{C}$	
I_{GES}	Gate-to-Emitter Leakage Current	—	—	± 100	nA	$V_{GE} = \pm 30V$	

Switching Characteristics @ $T_J = 25^\circ\text{C}$ (unless otherwise specified)

	Parameter	Min.	Typ.	Max.	Units	Conditions	Ref.Fig
Q_g	Total Gate Charge (turn-on)	—	73	110	nC	$I_C = 40A$ $V_{GE} = 15V$ $V_{CC} = 240V$	23
Q_{ge}	Gate-to-Emitter Charge (turn-on)	—	13	20			CT1
Q_{gc}	Gate-to-Collector Charge (turn-on)	—	26	39			
E_{on}	Turn-On Switching Loss	—	409	525	μJ	$I_C = 40A, V_{CC} = 240V, V_{GE} = 15V$ $R_G = 10\Omega, L = 200\mu H, T_J = 25^\circ\text{C}$ Energy losses include tail & diode reverse recovery	CT3
E_{off}	Turn-Off Switching Loss	—	838	1017			
E_{total}	Total Switching Loss	—	1247	1542			
$t_{d(on)}$	Turn-On delay time	—	18	23	ns	$I_C = 40A, V_{CC} = 240V, V_{GE} = 15V$ $R_G = 10\Omega, L = 200\mu H, T_J = 25^\circ\text{C}$	CT3
t_r	Rise time	—	36	50			
$t_{d(off)}$	Turn-Off delay time	—	144	121			
t_f	Fall time	—	95	124			
E_{on}	Turn-On Switching Loss	—	713	—			μJ
E_{off}	Turn-Off Switching Loss	—	1076	—	CT3		
E_{total}	Total Switching Loss	—	1789	—	WF1, WF2		
$t_{d(on)}$	Turn-On delay time	—	16	—	ns	$I_C = 40A, V_{CC} = 240V, V_{GE} = 15V$ $R_G = 10\Omega, L = 200\mu H$ $T_J = 150^\circ\text{C}$	14, 16
t_r	Rise time	—	39	—			CT3
$t_{d(off)}$	Turn-Off delay time	—	176	—			WF1
t_f	Fall time	—	133	—			WF2
C_{ies}	Input Capacitance	—	2265	—			pF
C_{oes}	Output Capacitance	—	190	—			
C_{res}	Reverse Transfer Capacitance	—	58	—			
RBSOA	Reverse Bias Safe Operating Area	FULL SQUARE				$T_J = 150^\circ\text{C}, I_C = 120A$ $V_{CC} = 240V, V_p = 300V$ $R_g = 10\Omega, V_{GE} = +15V \text{ to } 0V$	4 CT2
E_{rec}	Reverse Recovery Energy of the Diode	—	909	—	μJ	$T_J = 150^\circ\text{C}$	17, 18, 19
t_{rr}	Diode Reverse Recovery Time	—	122	—	ns	$V_{CC} = 240V, I_F = 40A$	20, 21
I_{rr}	Peak Reverse Recovery Current	—	36	—	A	$V_{GE} = 15V, R_g = 10\Omega, L = 200\mu H, L_s = 150nH$	WF3

Notes:

- ① $V_{CC} = 80\% (V_{CES}), V_{GE} = 15V, L = 200\mu H, R_G = 10\Omega.$
- ② This is only applied to TO-247AC package.
- ③ Pulse width limited by max. junction temperature.

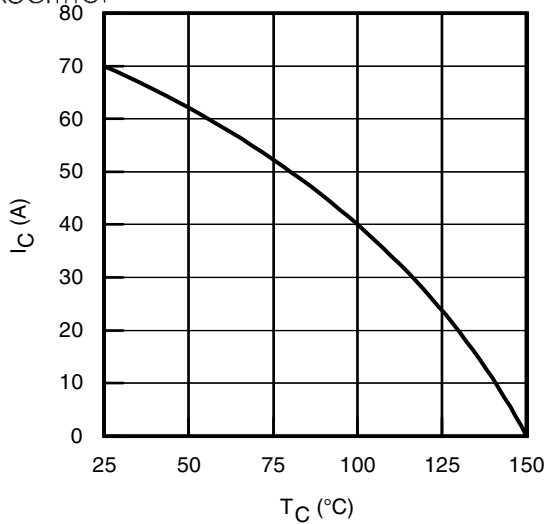

Fig. 1 - Maximum DC Collector Current vs. Case Temperature

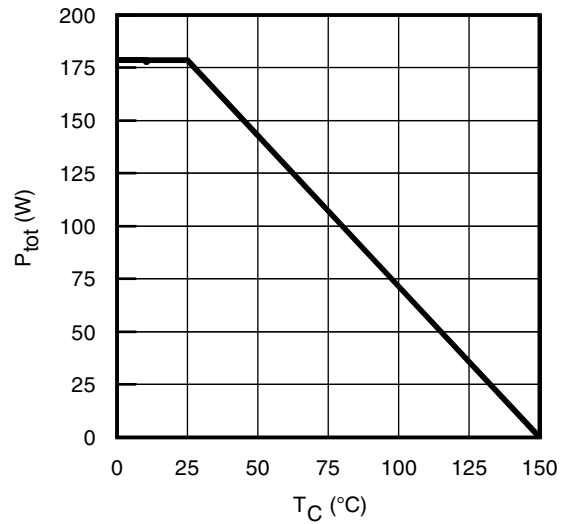

Fig. 2 - Power Dissipation vs. Case Temperature

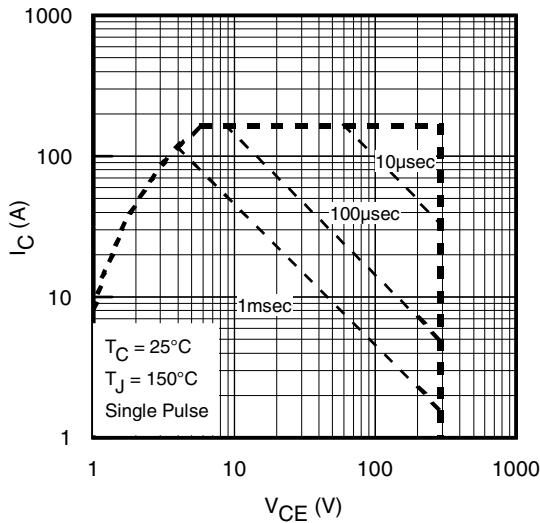

Fig. 3 - Forward SOA

$T_C = 25^{\circ}C$, $T_J \leq 150^{\circ}C$; $V_{GE} = 15V$

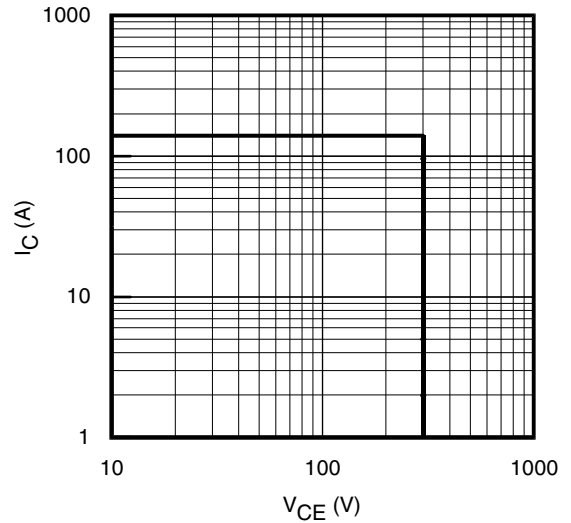

Fig. 4 - Reverse Bias SOA

$T_J = 150^{\circ}C$; $V_{GE} = 15V$

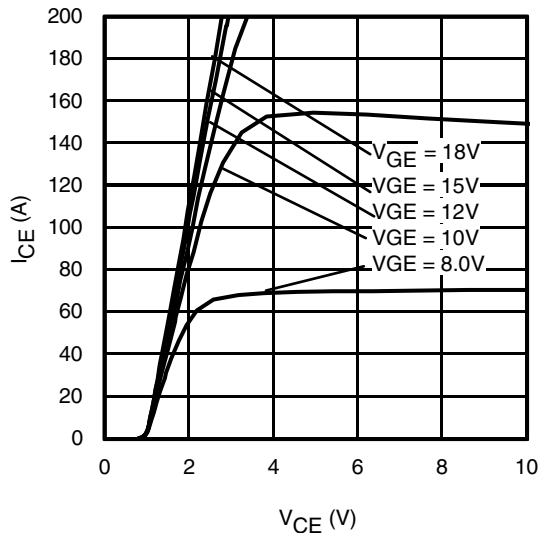

Fig. 5 - Typ. IGBT Output Characteristics
 $T_J = -40^{\circ}C$; $t_p = 60\mu s$

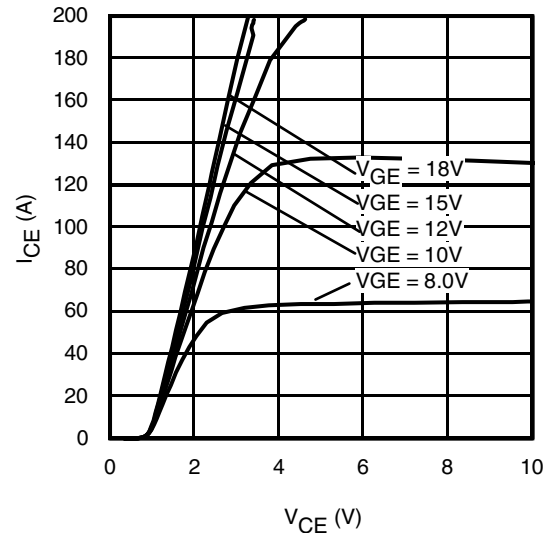

Fig. 6 - Typ. IGBT Output Characteristics
 $T_J = 25^{\circ}C$; $t_p = 60\mu s$

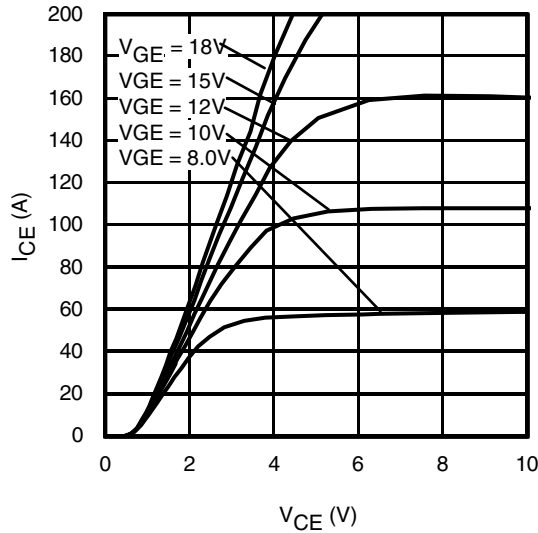

Fig. 7 - Typ. IGBT Output Characteristics
 $T_J = 150^\circ\text{C}$; $t_p = 60\mu\text{s}$

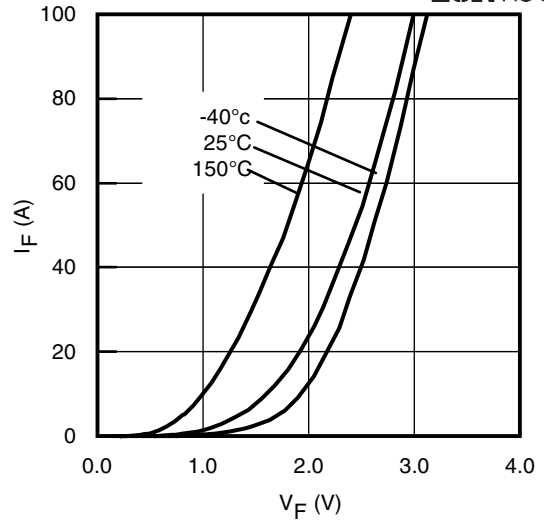

Fig. 8 - Typ. Diode Forward Characteristics
 $t_p = 60\mu\text{s}$

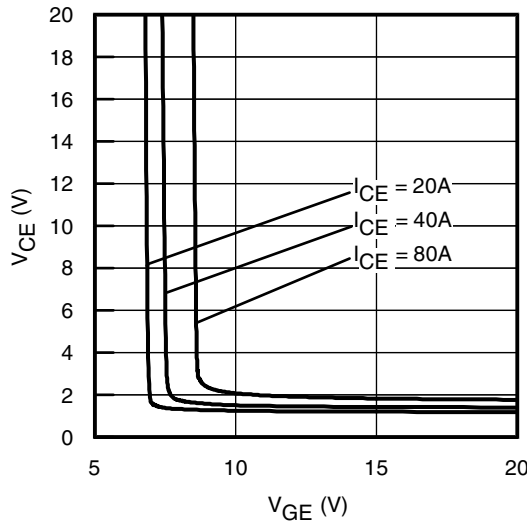

Fig. 9 - Typical V_{CE} vs. V_{GE}
 $T_J = -40^\circ\text{C}$

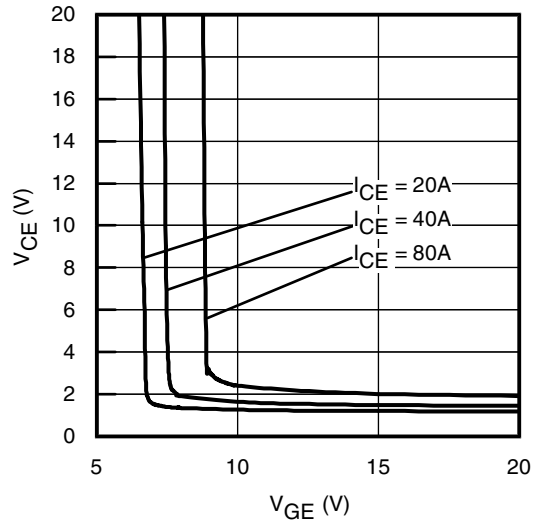

Fig. 10 - Typical V_{CE} vs. V_{GE}
 $T_J = 25^\circ\text{C}$

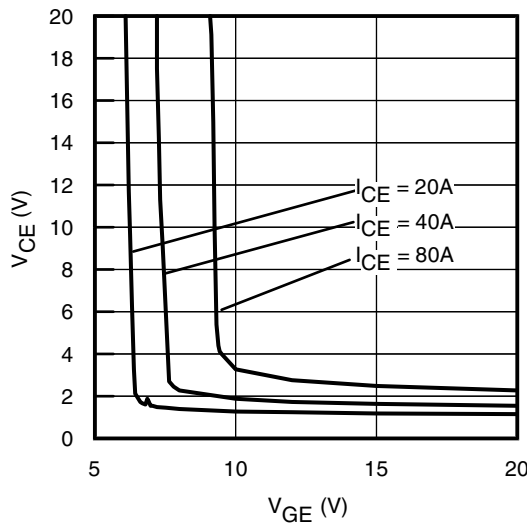

Fig. 11 - Typical V_{CE} vs. V_{GE}
 $T_J = 150^\circ\text{C}$

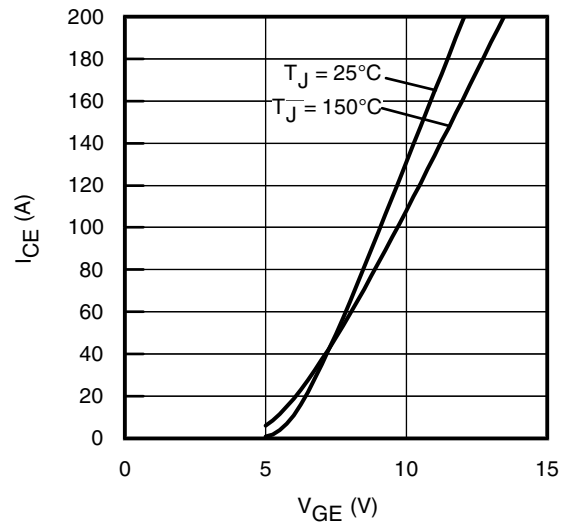

Fig. 12 - Typ. Transfer Characteristics
 $V_{CE} = 50\text{V}$; $t_p = 10\mu\text{s}$

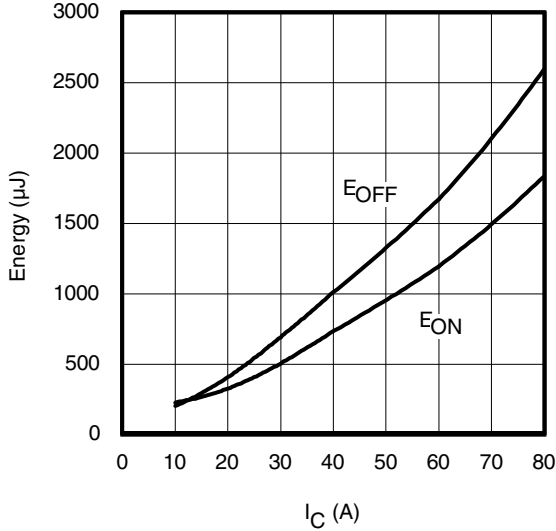

Fig. 13 - Typ. Energy Loss vs. I_C

$T_J = 150^\circ\text{C}$; $L = 200\mu\text{H}$; $V_{CE} = 240\text{V}$, $R_G = 10\Omega$; $V_{GE} = 15\text{V}$

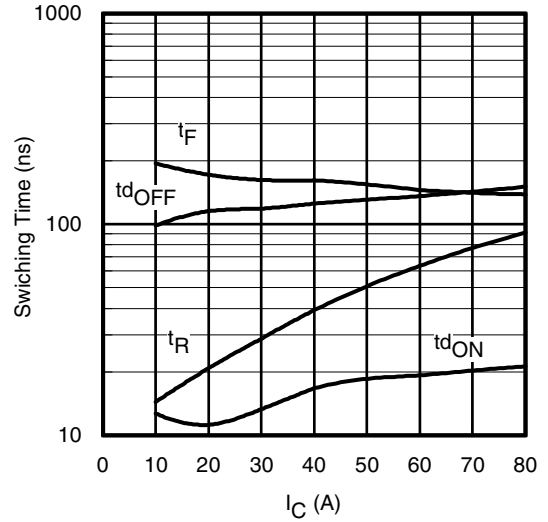

Fig. 14 - Typ. Switching Time vs. I_C

$T_J = 150^\circ\text{C}$; $L = 200\mu\text{H}$; $V_{CE} = 240\text{V}$, $R_G = 10\Omega$; $V_{GE} = 15\text{V}$

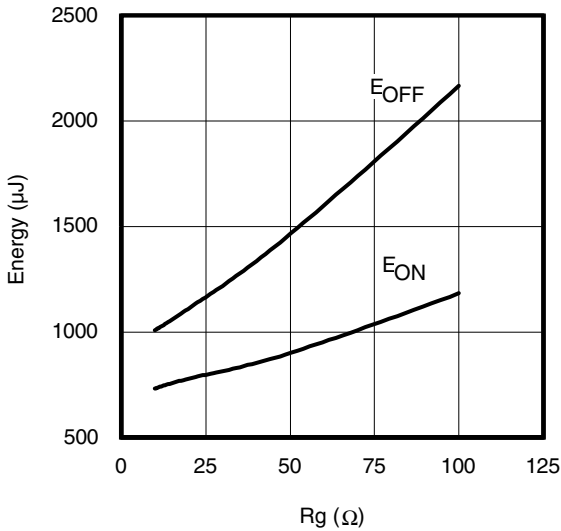

Fig. 15 - Typ. Energy Loss vs. R_G

$T_J = 150^\circ\text{C}$; $L = 200\mu\text{H}$; $V_{CE} = 240\text{V}$, $I_{CE} = 40\text{A}$; $V_{GE} = 15\text{V}$

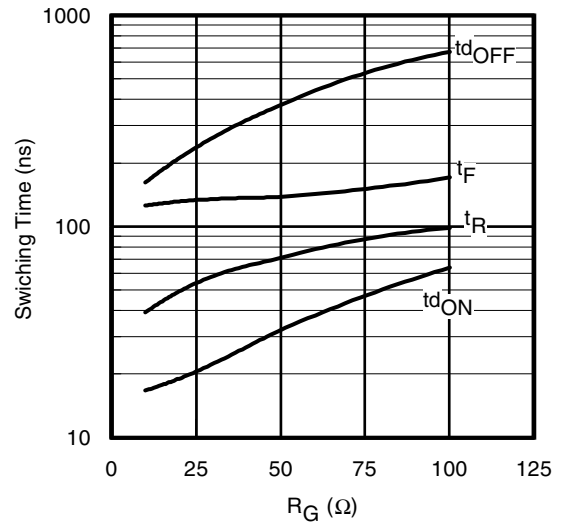

Fig. 16 - Typ. Switching Time vs. R_G

$T_J = 150^\circ\text{C}$; $L = 200\mu\text{H}$; $V_{CE} = 240\text{V}$, $I_{CE} = 40\text{A}$; $V_{GE} = 15\text{V}$

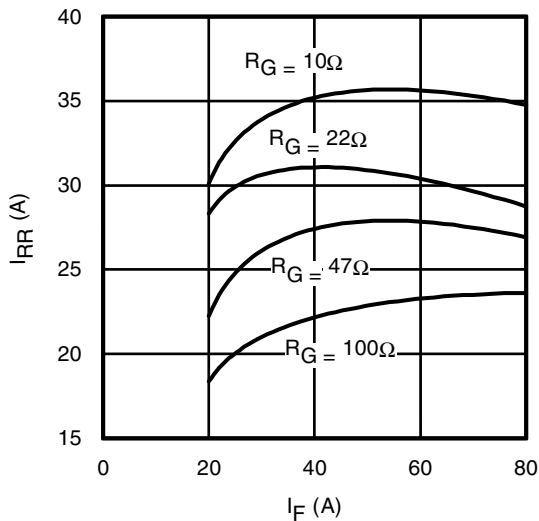

Fig. 17 - Typ. Diode I_{RR} vs. I_F

$T_J = 150^\circ\text{C}$

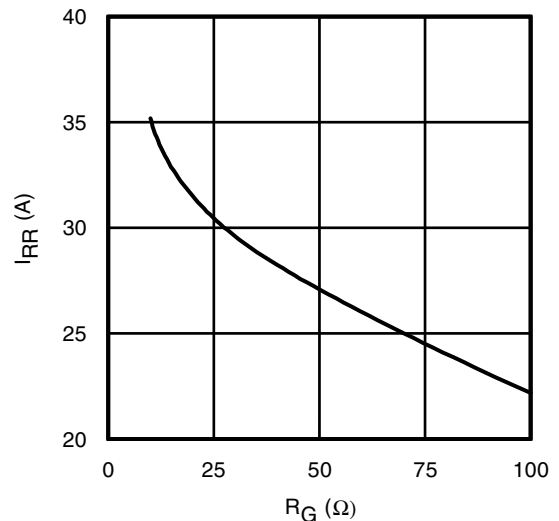

Fig. 18 - Typ. Diode I_{RR} vs. R_G

$T_J = 150^\circ\text{C}$

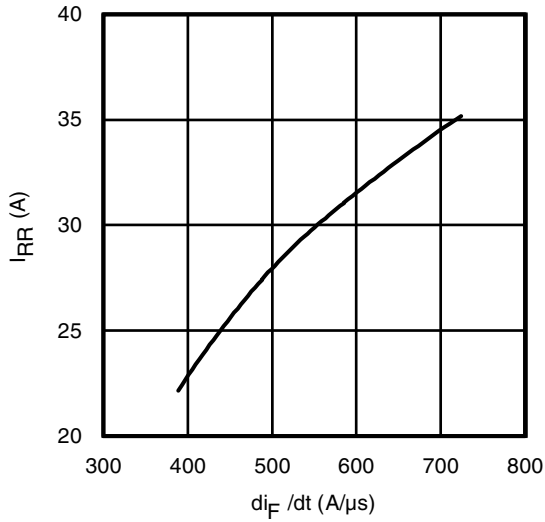

Fig. 19 - Typ. Diode I_{RR} vs. di_F/dt
 $V_{CC} = 240V$; $V_{GE} = 15V$; $I_F = 40A$; $T_J = 150^\circ C$

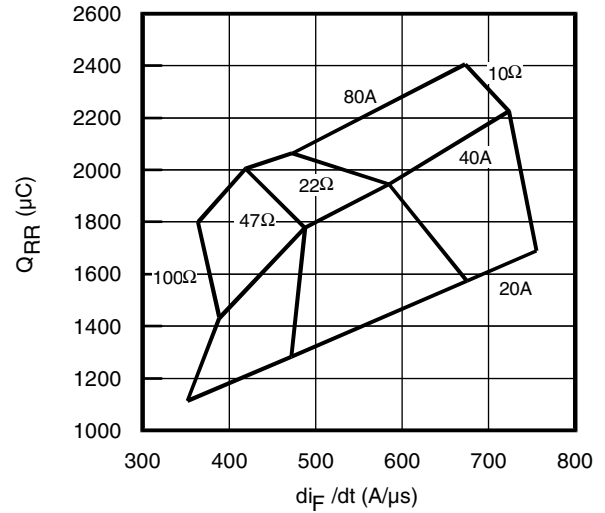

Fig. 20 - Typ. Diode Q_{RR} vs. di_F/dt
 $V_{CC} = 240V$; $V_{GE} = 15V$; $T_J = 150^\circ C$

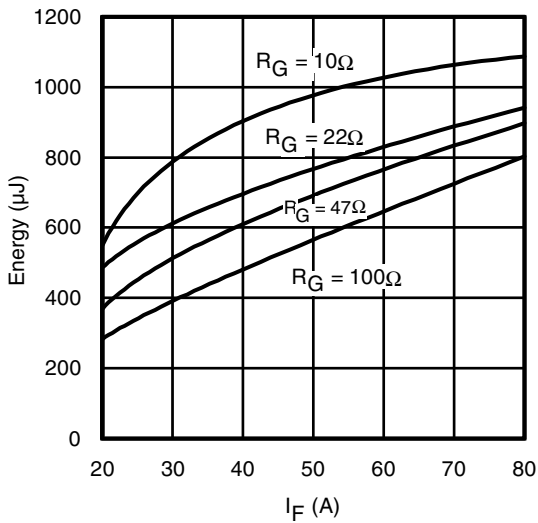

Fig. 21 - Typ. Diode E_{RR} vs. I_F
 $T_J = 150^\circ C$

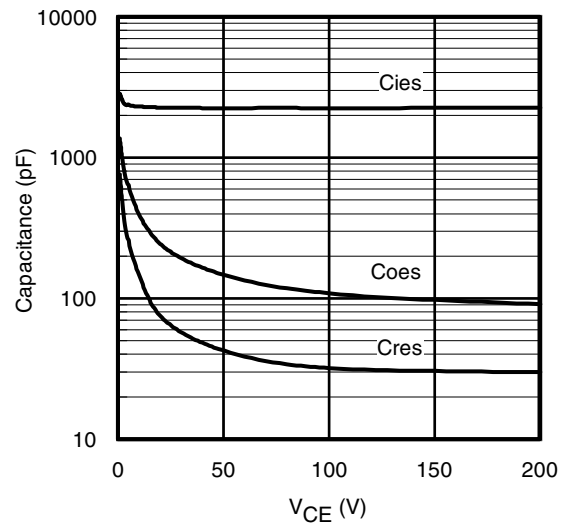

Fig. 22 - Typ. Capacitance vs. V_{CE}
 $V_{GE} = 0V$; $f = 1MHz$

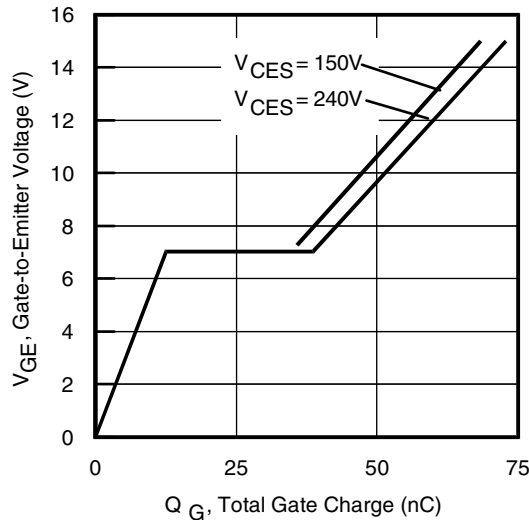

Fig. 23 - Typical Gate Charge vs. V_{GE}
 $I_{CE} = 40A$; $L = 100\mu H$

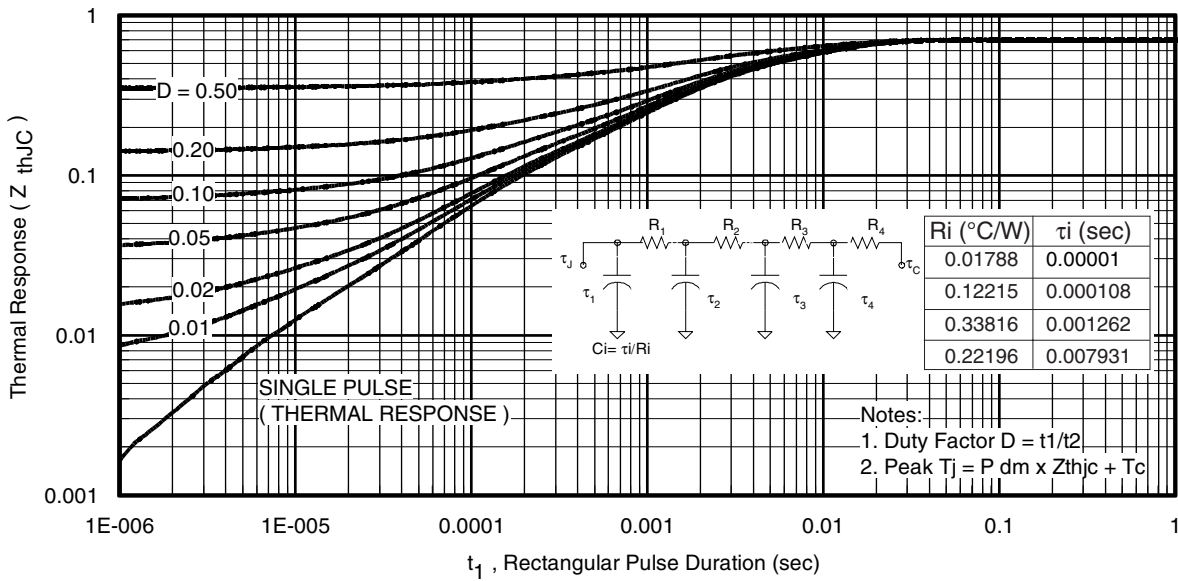

Fig 24. Maximum Transient Thermal Impedance, Junction-to-Case (IGBT)

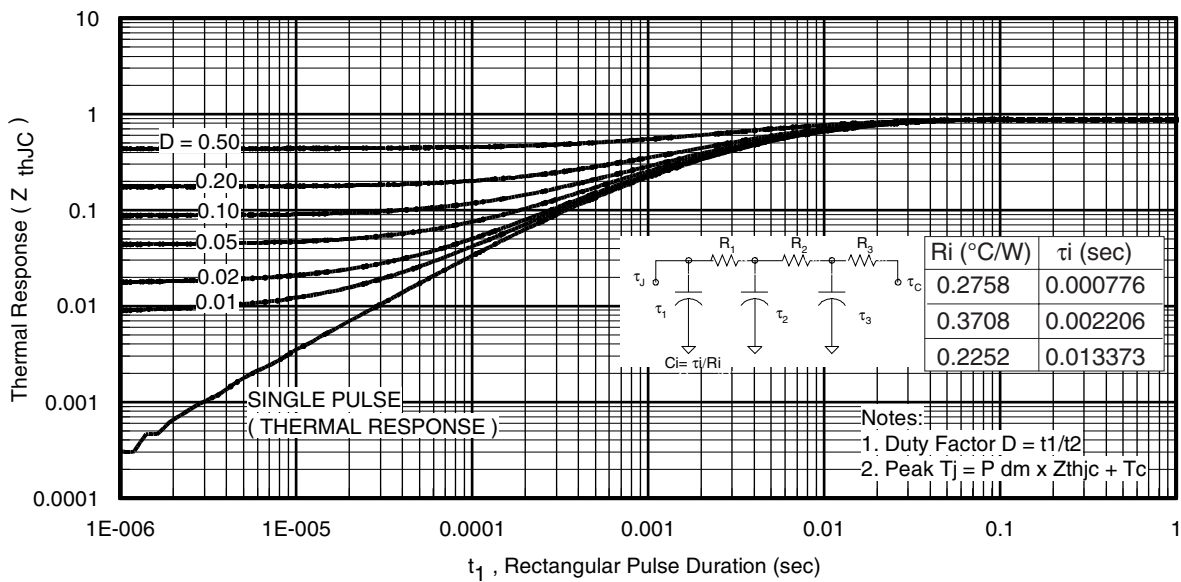

Fig. 25. Maximum Transient Thermal Impedance, Junction-to-Case (DIODE)

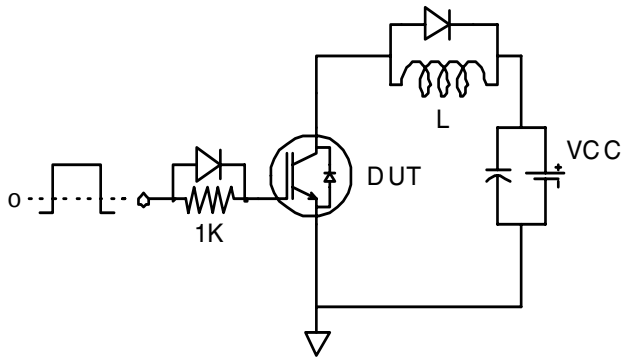

Fig.C.T.1 - Gate Charge Circuit (turn-off)

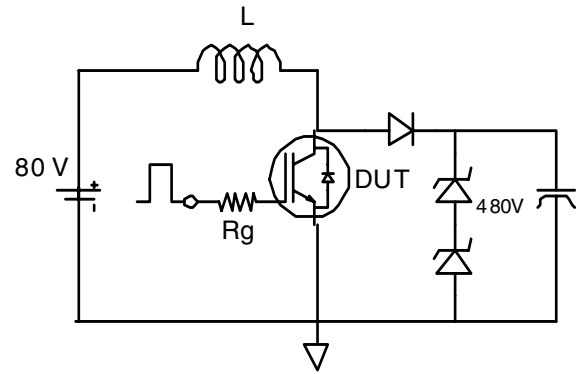

Fig.C.T.2 - RBSOA Circuit

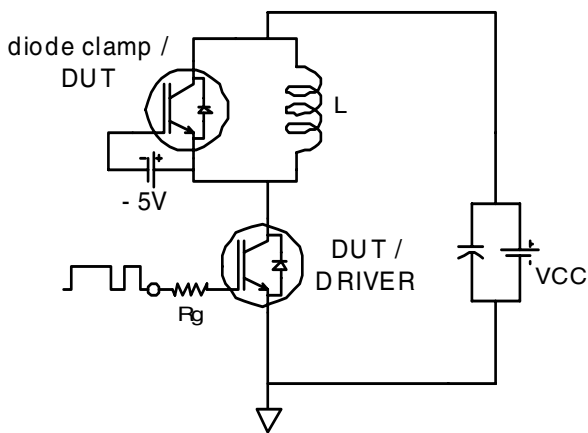

Fig.C.T.3 - Switching Loss Circuit

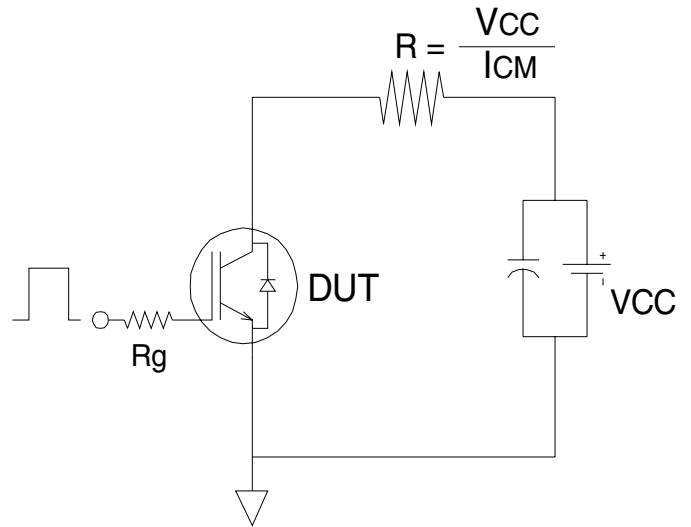

Fig.C.T.4 - Resistive Load Circuit

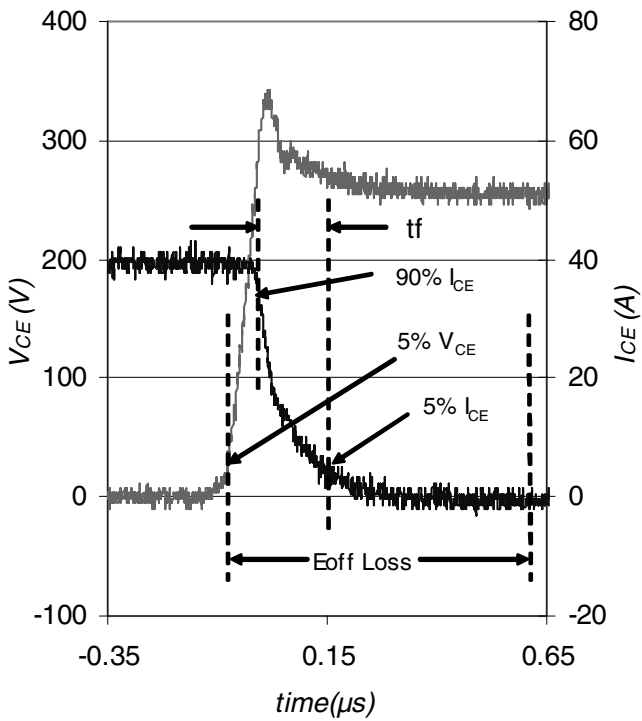

Fig. WF1 - Typ. Turn-off Loss Waveform
@ $T_J = 150^\circ\text{C}$ using Fig. CT.3

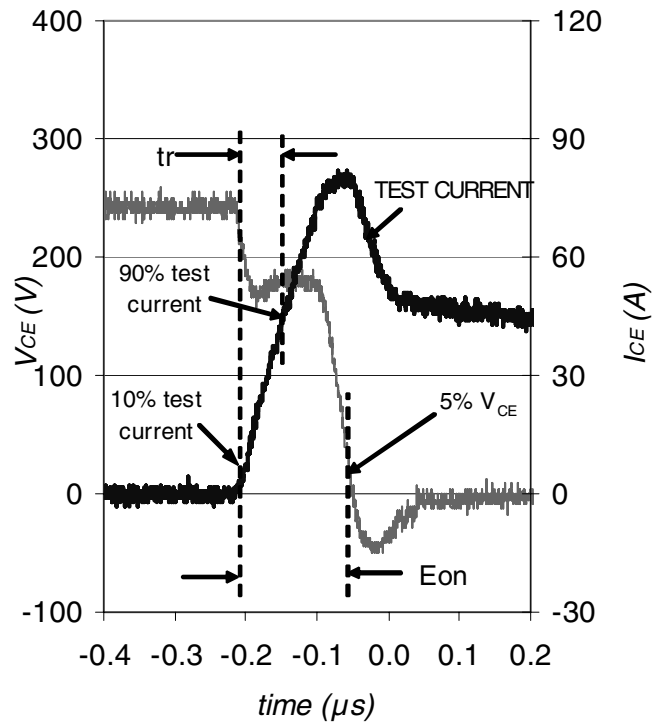

Fig. WF2 - Typ. Turn-on Loss Waveform
@ $T_J = 150^\circ\text{C}$ using Fig. CT.3

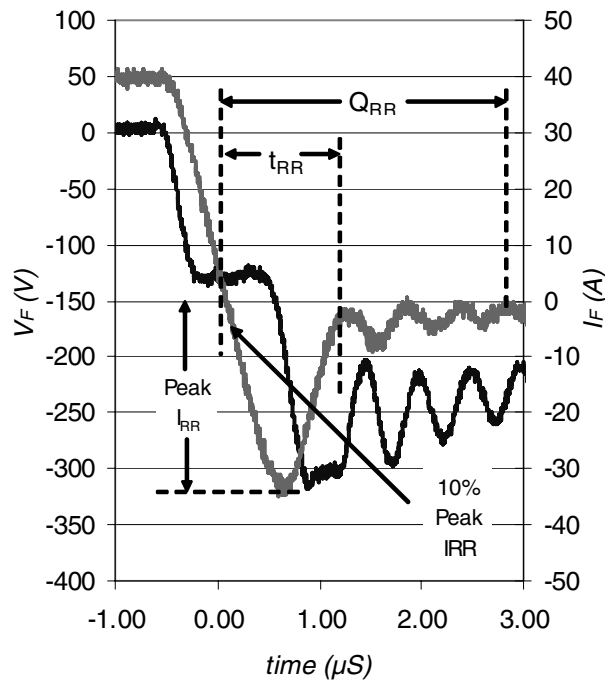
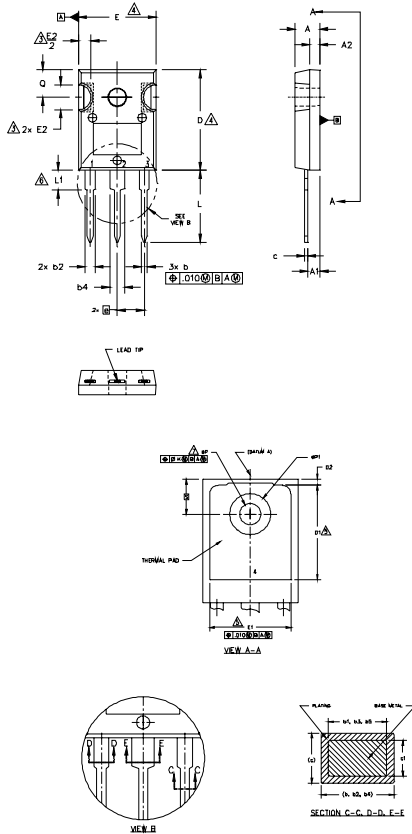

Fig. WF3 - Typ. Diode Recovery Waveform
@ $T_J = 150^\circ\text{C}$ using Fig. CT.3

IRGP4072DPbF

TO-247AC Package Outline

Dimensions are shown in millimeters (inches)



- NOTES:
1. DIMENSIONING AND TOLERANCING AS PER ASME Y14.5M 1994.
 2. DIMENSIONS ARE SHOWN IN INCHES.
 3. CONTOUR OF SLOT OPTIONAL.
 4. DIMENSION D & E DO NOT INCLUDE MOLD FLASH. MOLD FLASH SHALL NOT EXCEED .005" (0.127) PER SIDE. THESE DIMENSIONS ARE MEASURED AT THE OUTERMOST EXTREMES OF THE PLASTIC BODY.
 5. THERMAL PAD CONTOUR OPTIONAL WITHIN DIMENSIONS D1 & E1.
 6. LEAD FINISH UNCONTROLLED IN L1.
 7. ØP TO HAVE A MAXIMUM DRAFT ANGLE OF 1.5° TO THE TOP OF THE PART WITH A MAXIMUM HOLE DIAMETER OF .154 INCH.
 8. OUTLINE CONFORMS TO JEDEC OUTLINE TO-247AC .

SYMBOL	DIMENSIONS				NOTES
	INCHES		MILLIMETERS		
	MIN.	MAX.	MIN.	MAX.	
A	.185	.209	4.65	5.31	
A1	.087	.102	2.21	2.59	
A2	.059	.098	1.50	2.49	
b	.039	.055	0.99	1.40	
b1	.039	.053	0.99	1.35	
b2	.065	.094	1.65	2.39	
b3	.065	.092	1.65	2.34	
b4	.102	.135	2.59	3.43	
b5	.102	.133	2.59	3.38	
c	.015	.035	0.38	0.89	
c1	.015	.033	0.38	0.84	
D	.776	.815	19.71	20.70	4
D1	.515	-	13.08	-	5
D2	.020	.053	0.51	1.35	
E	.602	.625	15.29	15.87	4
E1	.530	-	13.46	-	
E2	.178	.216	4.52	5.49	
e	.215 BSC		5.46 BSC		
Øk	.010		0.25		
L	.559	.634	14.20	16.10	
L1	.146	.169	3.71	4.29	
ØP	.140	.144	3.56	3.66	
ØP1	-	.291	-	7.39	
D	.209	.224	5.31	5.69	
S	.217 BSC		5.51 BSC		

LEAD ASSIGNMENTS

HEXFEEET

- 1.- GATE
- 2.- DRAIN
- 3.- SOURCE
- 4.- DRAIN

IGBTs, CoPACK

- 1.- GATE
- 2.- COLLECTOR
- 3.- EMITTER
- 4.- COLLECTOR

DIODES

- 1.- ANODE/OPEN
- 2.- CATHODE
- 3.- ANODE

TO-247AC Part Marking Information

EXAMPLE: THIS IS AN IRFPE30
WITH ASSEMBLY
LOT CODE 5657
ASSEMBLED ON WW 35, 2001
IN THE ASSEMBLY LINE "H"

Note: "P" in assembly line position
indicates "Lead-Free"

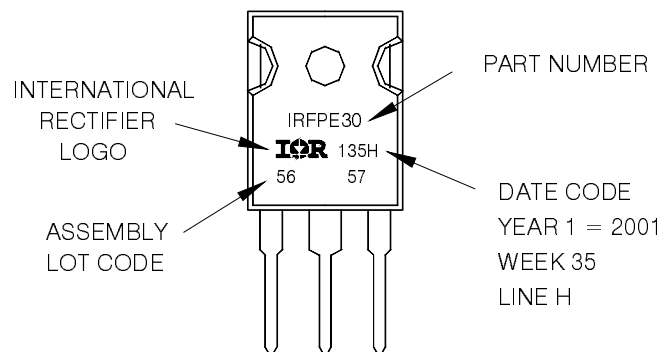

TO-247AC package is not recommended for Surface Mount Application.

Note: For the most current drawing please refer to IR website at <http://www.irf.com/package/>

Data and specifications subject to change without notice.
This product has been designed and qualified for Industrial market.
Qualification Standards can be found on IR's Web site.

单击下面可查看定价，库存，交付和生命周期等信息

[>>Infineon Technologies\(英飞凌\)](#)