

Automotive DirectFET® Power MOSFET ②

- Advanced Process Technology
- Optimized for Automotive Motor Drive, DC-DC and other Heavy Load Applications
- Exceptionally Small Footprint and Low Profile
- High Power Density
- Low Parasitic Parameters
- Dual Sided Cooling
- 175°C Operating Temperature
- Repetitive Avalanche Allowed up to Tjmax
- Lead Free, RoHS Compliant and Halogen Free
- Automotive Qualified \*

$V_{(BR)DSS}$	<b>60V</b>
$R_{DS(on)}$ <b>typ.</b>	<b>1.1mΩ</b>
<b>max.</b>	<b>1.5mΩ</b>
$I_D$ (Silicon Limited)	<b>345A</b>
$Q_g$	<b>183nC</b>

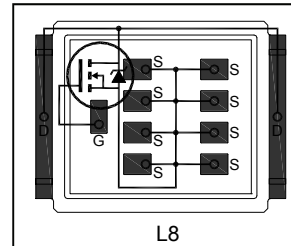

Applicable DirectFET® Outline and Substrate Outline ①

SB	SC		M2	M4		L4	L6	<b>L8</b>	
----	----	--	----	----	--	----	----	-----------	--

**Description**

The AUIRF7749L2 combines the latest Automotive HEXFET® Power MOSFET Silicon technology with the advanced DirectFET® packaging technology to achieve exceptional performance in a package that has the footprint of a D-Pak (TO-252AA) and only 0.7mm profile. The DirectFET® package is compatible with existing layout geometries used in power applications, PCB assembly equipment and vapor phase, infra-red or convection soldering techniques, when [application note AN-1035](#) is followed regarding the manufacturing methods and processes. The DirectFET® package allows dual sided cooling to maximize thermal transfer in automotive power systems.

This HEXFET® Power MOSFET is designed for applications where efficiency and power density are of value. The advanced DirectFET® packaging platform coupled with the latest silicon technology allows the AUIRF7749L2 to offer substantial system level savings and performance improvement specifically in motor drive, DC-DC and other heavy load applications on ICE, HEV and EV platforms. This MOSFET utilizes the latest processing techniques to achieve ultra low on-resistance per silicon area. Additional features of this MOSFET are 175°C operating junction temperature and high repetitive peak current capability. These features combine to make this MOSFET a highly efficient, robust and reliable device for high current automotive applications.

Base Part Number	Package Type	Standard Pack		Orderable Part Number
		Form	Quantity	
AUIRF7749L2	DirectFET®	Tape and Reel	4000	AUIRF7749L2TR

**Absolute Maximum Ratings**

Stresses beyond those listed under "Absolute Maximum Ratings" may cause permanent damage to the device. These are stress ratings only; and functional operation of the device at these or any other condition beyond those indicated in the specifications is not implied. Exposure to absolute-maximum-rated conditions for extended periods may affect device reliability. The thermal resistance and power dissipation ratings are measured under board mounted and still air conditions. Ambient temperature (TA) is 25°C, unless otherwise specified.

	Parameter	Max.	Units
$V_{GS}$	Gate-to-Source Voltage	60	V
$I_D @ T_C = 25^\circ C$	Continuous Drain Current, $V_{GS} @ 10V$ ④	345	A
$I_D @ T_C = 100^\circ C$	Continuous Drain Current, $V_{GS} @ 10V$ ④	243	
$I_D @ T_A = 25^\circ C$	Continuous Drain Current, $V_{GS} @ 10V$ ③	36	
$I_D @ T_C = 25^\circ C$	Continuous Drain Current, $V_{GS} @ 10V$ (Package limit) ④	375	
$I_{DM}$	Pulsed Drain Current ⑤	1380	
$P_D @ T_C = 25^\circ C$	Power Dissipation ④	341	W
$P_D @ T_A = 25^\circ C$	Power Dissipation ③	3.8	
$E_{AS}$	Single Pulse Avalanche Energy (Thermally Limited) ⑥	315	mJ
$E_{AS} (Tested)$	Single Pulse Avalanche Energy ⑥	714	
$I_{AR}$	Avalanche Current ⑤	See Fig. 16, 17, 18a, 18b	A
$E_{AR}$	Repetitive Avalanche Energy ⑤		mJ
$T_P$	Peak Soldering Temperature	270	°C
$T_J$	Operating Junction and	-55 to + 175	
$T_{STG}$	Storage Temperature Range		

HEXFET® is a registered trademark of International Rectifier.

\*Qualification standards can be found at <http://www.irf.com/>

**Thermal Resistance**

Symbol	Parameter	Typ.	Max.	Units
$R_{\theta JA}$	Junction-to-Ambient ③	—	40	°C/W
$R_{\theta JA}$	Junction-to-Ambient ⑧	12.5	—	
$R_{\theta JA}$	Junction-to-Ambient ⑨	20	—	
$R_{\theta J-Can}$	Junction-to-Can ④⑩	—	0.44	
$R_{\theta J-PCB}$	Junction-to-PCB Mounted	—	0.5	
	Linear Derating Factor ④	2.3		W/°C

**Static Electrical Characteristics @  $T_J = 25^\circ\text{C}$  (unless otherwise specified)**

Symbol	Parameter	Min.	Typ.	Max.	Units	Conditions
$V_{(BR)DSS}$	Drain-to-Source Breakdown Voltage	60	—	—	V	$V_{GS} = 0V, I_D = 250\mu A$
$\Delta V_{(BR)DSS}/\Delta T_J$	Breakdown Voltage Temp. Coefficient	—	56	—	mV/°C	Reference to $25^\circ\text{C}, I_D = 3.0\text{mA}$
$R_{DS(on)}$	Static Drain-to-Source On-Resistance	—	1.1	1.5	mΩ	$V_{GS} = 10V, I_D = 120A$ ⑦
$V_{GS(th)}$	Gate Threshold Voltage	2.0	—	4.0	V	$V_{DS} = V_{GS}, I_D = 250\mu A$
$\Delta V_{GS(th)}/\Delta T_J$	Gate Threshold Voltage Coefficient	—	-8.8	—	mV/°C	
$g_{fs}$	Forward Trans conductance	185	—	—	S	$V_{DS} = 10V, I_D = 120A$
$R_G$	Internal Gate Resistance	—	1.5	—	Ω	
$I_{DSS}$	Drain-to-Source Leakage Current	—	—	20	μA	$V_{DS} = 60V, V_{GS} = 0V$
		—	—	250		$V_{DS} = 60V, V_{GS} = 0V, T_J = 125^\circ\text{C}$
$I_{GSS}$	Gate-to-Source Forward Leakage	—	—	100	nA	$V_{GS} = 20V$
	Gate-to-Source Reverse Leakage	—	—	-100		$V_{GS} = -20V$

**Dynamic Electrical Characteristics @  $T_J = 25^\circ\text{C}$  (unless otherwise specified)**

Symbol	Parameter	Min.	Typ.	Max.	Units	Conditions
$Q_g$	Total Gate Charge	—	183	275	nC	$V_{DS} = 30V$ $V_{GS} = 10V$ $I_D = 120A$
$Q_{gs1}$	Gate-to-Source Charge	—	39	—		
$Q_{gs2}$	Gate-to-Source Charge	—	19	—		
$Q_{gd}$	Gate-to-Drain ("Miller") Charge	—	46	—		
$Q_{godr}$	Gate Charge Overdrive	—	79	—		
$Q_{sw}$	Switch Charge ( $Q_{gs2} + Q_{gd}$ )	—	65	—		
$Q_{oss}$	Output Charge	—	119	—	nC	$V_{DS} = 48V, V_{GS} = 0V$
$t_{d(on)}$	Turn-On Delay Time	—	29	—	ns	$V_{DD} = 30V, V_{GS} = 10V$ ⑦ $I_D = 120A$ $R_G = 1.8\Omega$
$t_r$	Rise Time	—	149	—		
$t_{d(off)}$	Turn-Off Delay Time	—	72	—		
$t_f$	Fall Time	—	88	—		
$C_{iss}$	Input Capacitance	—	10655	—	pF	$V_{GS} = 0V$ $V_{DS} = 25V$ $f = 1.0\text{MHz}$ $V_{GS} = 0V, V_{DS} = 0V\text{ to }48V$
$C_{oss}$	Output Capacitance	—	1627	—		
$C_{riss}$	Reverse Transfer Capacitance	—	680	—		
$C_{oss\ eff.}$	Effective Output Capacitance	—	1959	—		

Notes ① through ⑩ are on page 11

**Diode Characteristics**

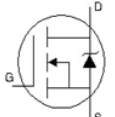
Symbol	Parameter	Min.	Typ.	Max.	Units	Conditions
$I_S$	Continuous Source Current (Body Diode)	—	—	345	A	MOSFET symbol showing the integral reverse p-n junction diode. 
$I_{SM}$	Pulsed Source Current (Body Diode) ⑤	—	—	1380		
$V_{SD}$	Diode Forward Voltage	—	—	1.3	V	$T_J = 25^\circ\text{C}$ , $I_S = 120\text{A}$ , $V_{GS} = 0\text{V}$ ⑦
$t_{rr}$	Reverse Recovery Time	—	42	—	ns	$I_F = 120\text{A}$ , $V_{DD} = 30\text{V}$
$Q_{rr}$	Reverse Recovery Charge	—	54	—	nC	$di/dt = 100\text{A}/\mu\text{s}$ ⑦

Notes ① through ⑩ are on page 11

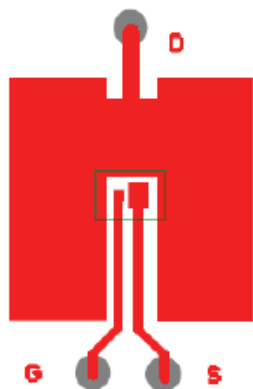

③ Surface mounted on 1 in. square Cu board (still air).



⑨ Mounted to a PCB with small clip heatsink (still air)

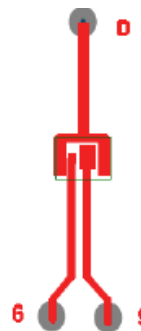

⑩ Mounted on minimum footprint full size board with metalized back and with small clip heatsink (still air).

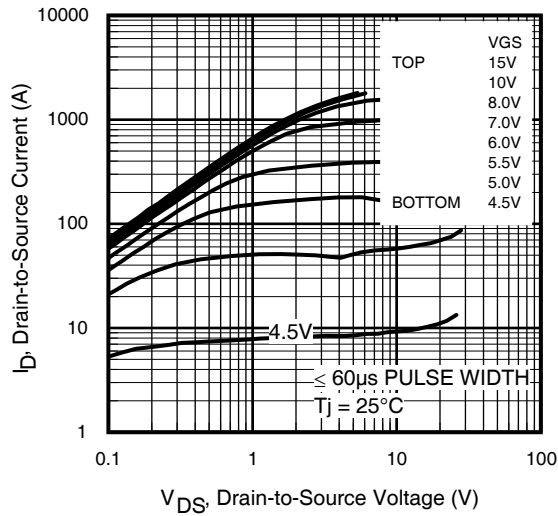

**Fig. 1** Typical Output Characteristics

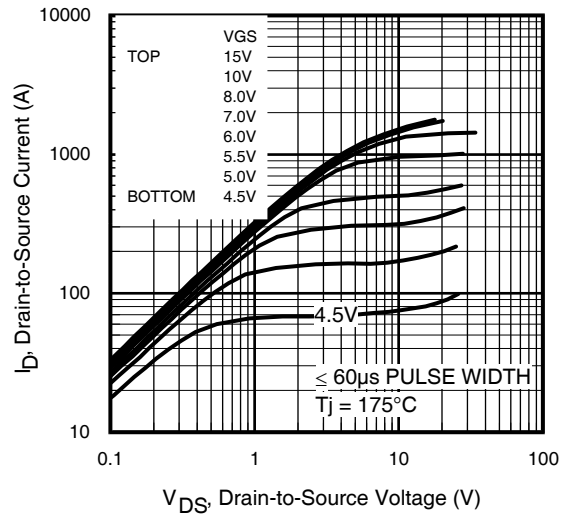

**Fig. 2** Typical Output Characteristics

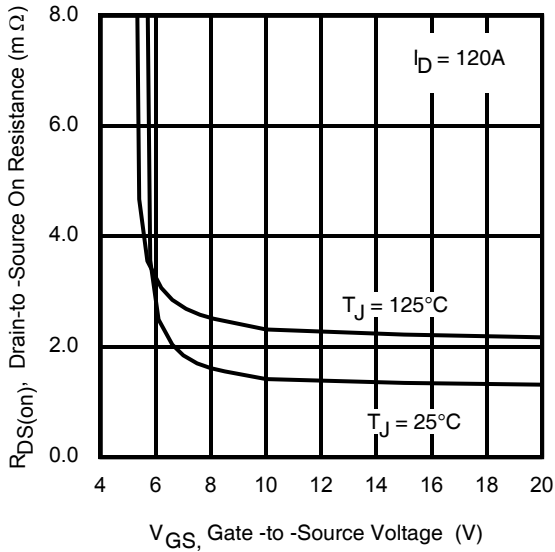

**Fig. 3** Typical On-Resistance vs. Gate Voltage

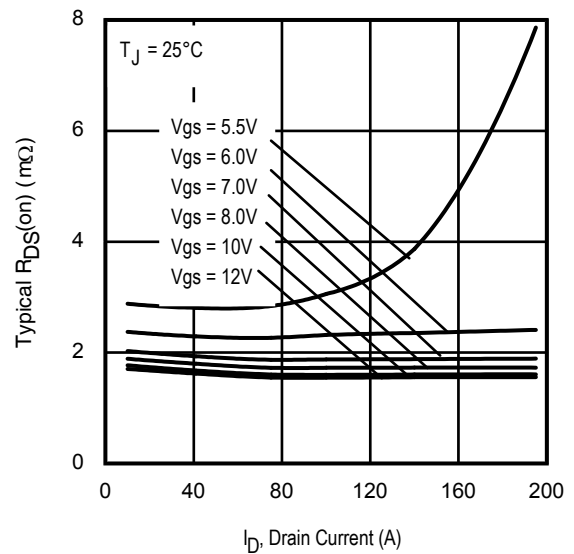

**Fig. 4** Typical On-Resistance vs. Drain Current

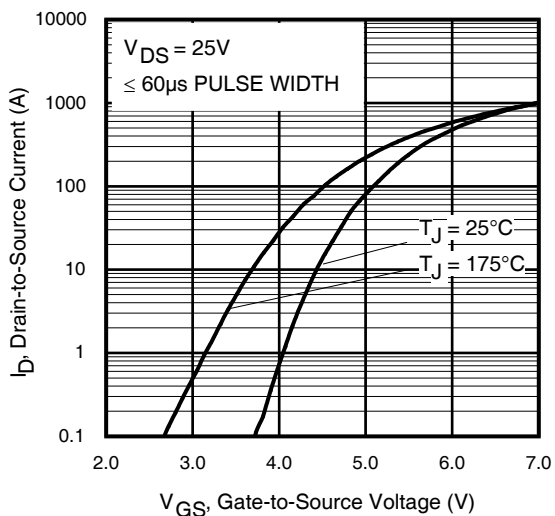

**Fig 5.** Transfer Characteristics

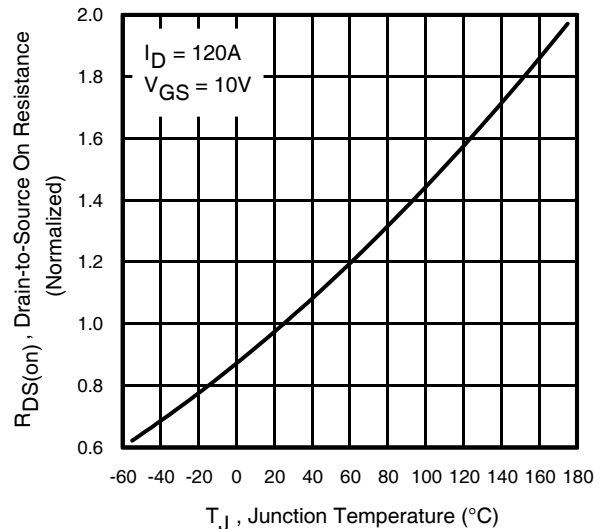

**Fig 6.** Normalized On-Resistance vs. Temperature

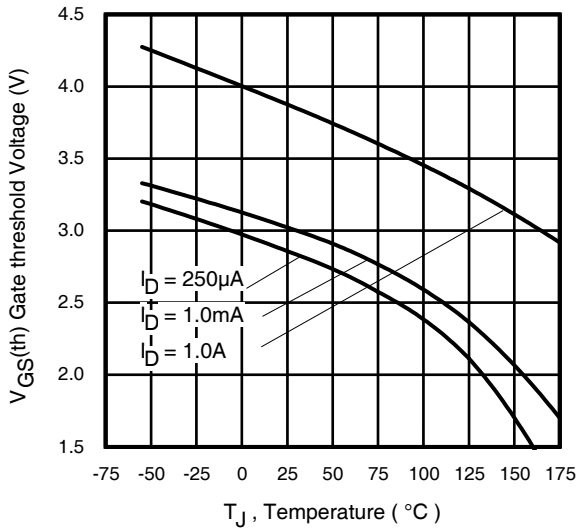

**Fig. 7** Typical Threshold Voltage vs.

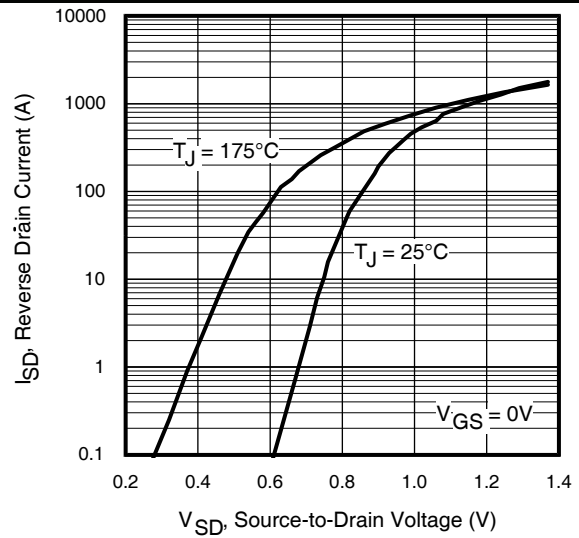

**Fig. 8.** Typical Source-Drain Diode Forward Voltage

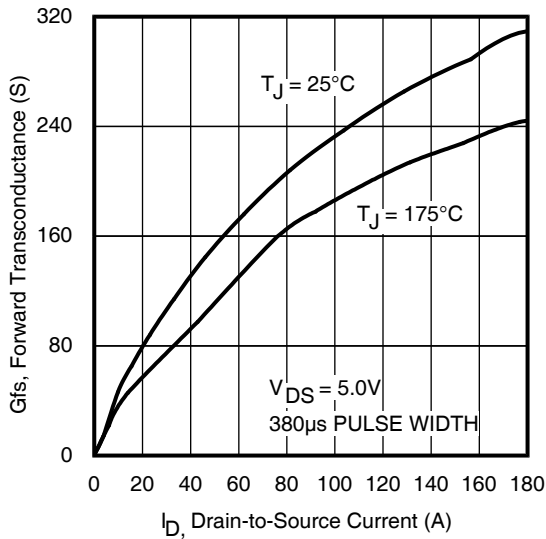

**Fig 9.** Typical Forward Trans conductance vs. Drain Current

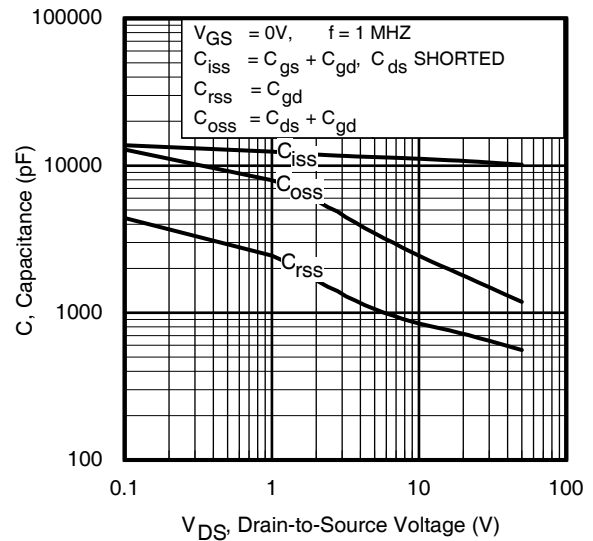

**Fig 10.** Typical Capacitance vs. Drain-to-Source Voltage

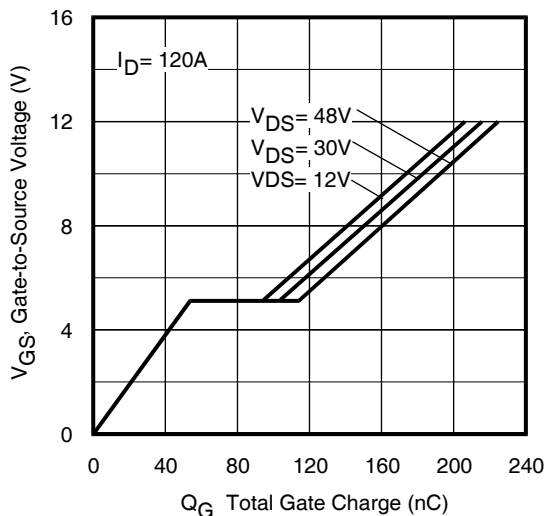

**Fig 11.** Typical Gate Charge vs. Gate-to-Source Voltage

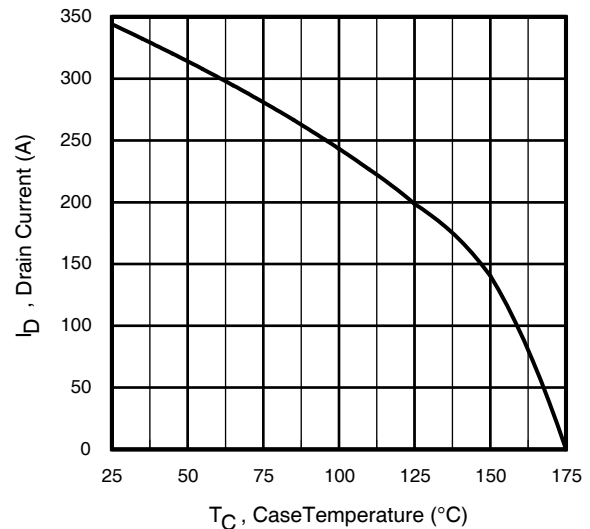

**Fig 12.** Maximum Drain Current vs. Case Temperature

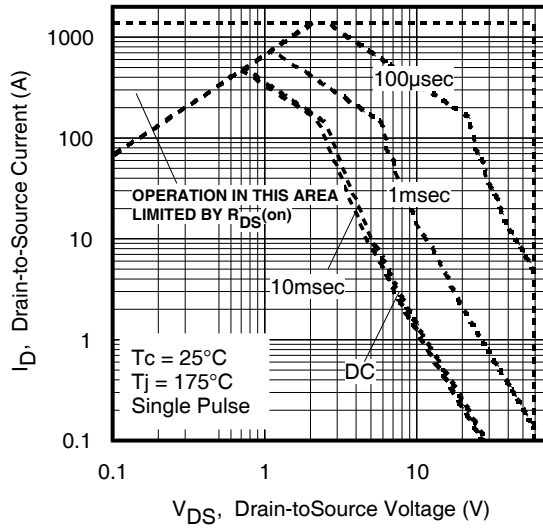

**Fig 13.** Maximum Safe Operating Area

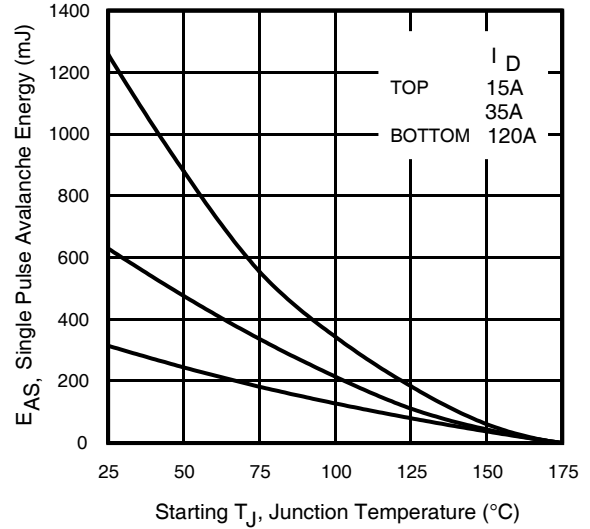

**Fig 14.** Maximum Avalanche Energy vs. Temperature

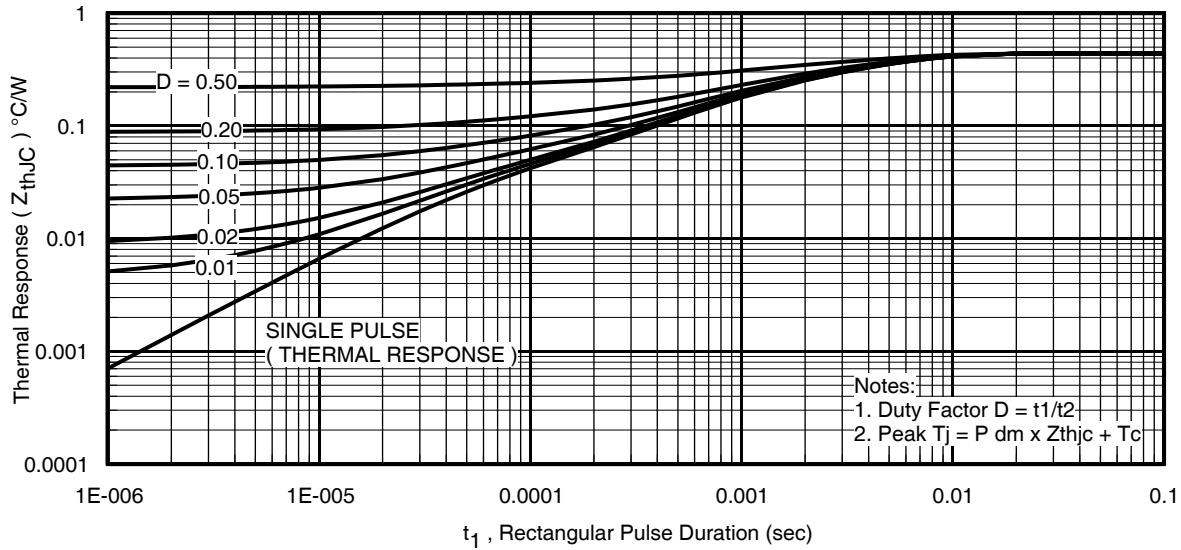

**Fig 15.** Maximum Effective Transient Thermal Impedance, Junction-to-Case

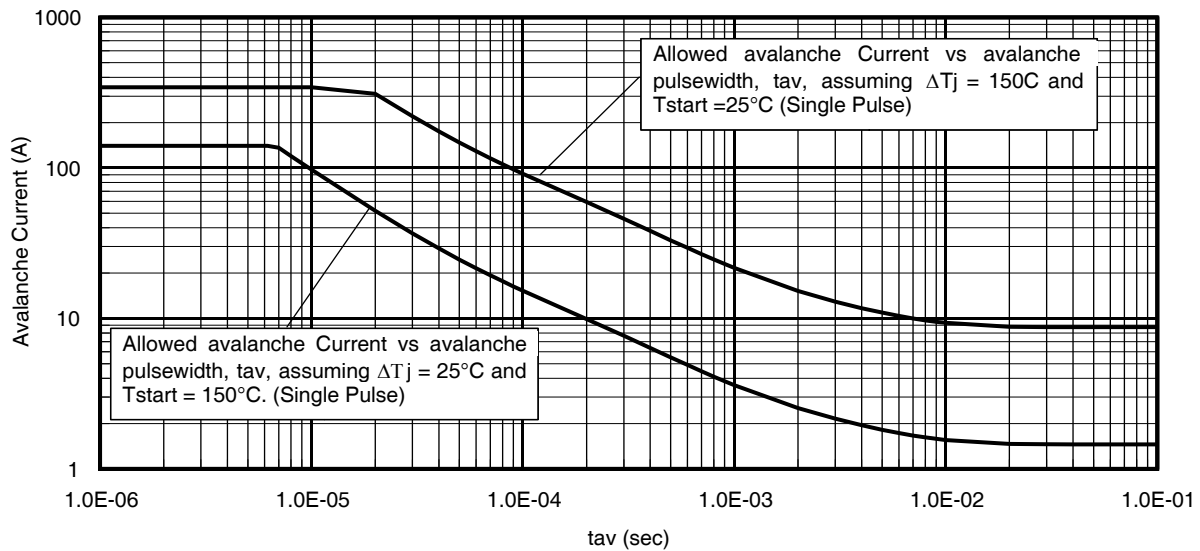

**Fig 16.** Typical Avalanche Current vs. Pulse Width

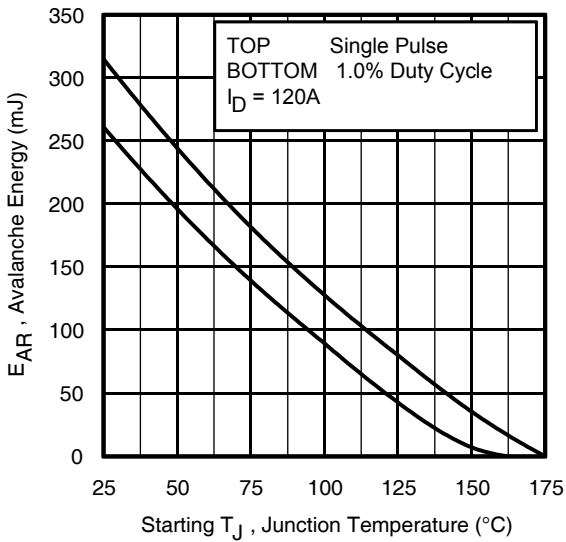

**Fig 17.** Maximum Avalanche Energy vs. Temperature

**Notes on Repetitive Avalanche Curves , Figures 16, 17:**

(For further info, see [AN-1005](#) at [www.irf.com](#))

1. Avalanche failures assumption:  
Purely a thermal phenomenon and failure occurs at a temperature far in excess of  $T_{jmax}$ . This is validated for every part type.
2. Safe operation in Avalanche is allowed as long as  $T_{jmax}$  is not exceeded.
3. Equation below based on circuit and waveforms shown in Figures 18a, 18b.
4.  $P_{D(ave)}$  = Average power dissipation per single avalanche pulse.
5.  $BV$  = Rated breakdown voltage (1.3 factor accounts for voltage increase during avalanche).
6.  $I_{av}$  = Allowable avalanche current.
7.  $\Delta T$  = Allowable rise in junction temperature, not to exceed  $T_{jmax}$  (assumed as 25°C in Figure 16, 17).  
 $t_{av}$  = Average time in avalanche.  
 $D$  = Duty cycle in avalanche =  $t_{av} \cdot f$   
 $Z_{thJC}(D, t_{av})$  = Transient thermal resistance, see Figures 15)

$$P_{D(ave)} = 1/2 ( 1.3 \cdot BV \cdot I_{av} ) = \Delta T / Z_{thJC}$$

$$I_{av} = 2\Delta T / [ 1.3 \cdot BV \cdot Z_{th} ]$$

$$E_{AS(AR)} = P_{D(ave)} \cdot t_{av}$$

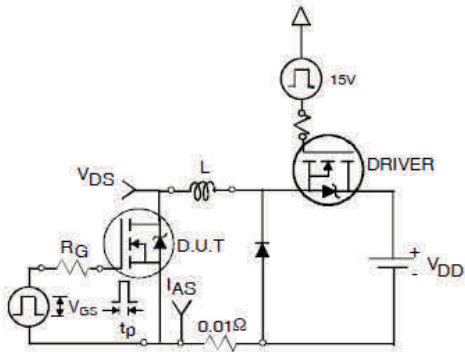

**Fig 18a.** Unclamped Inductive Test Circuit

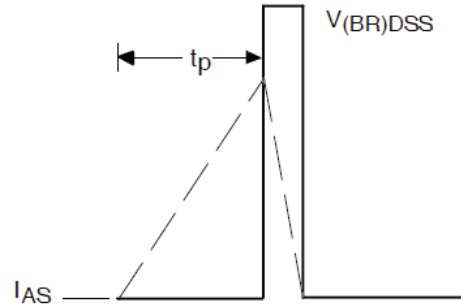

**Fig 18b.** Unclamped Inductive Waveforms

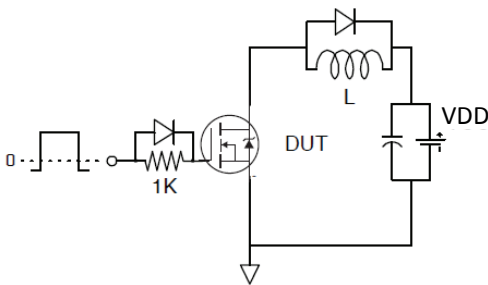

**Fig 19a.** Gate Charge Test Circuit

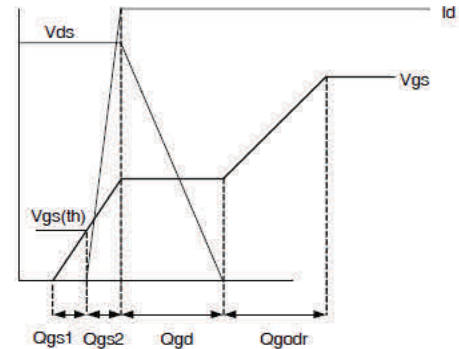

**Fig 19b.** Gate Charge Waveform

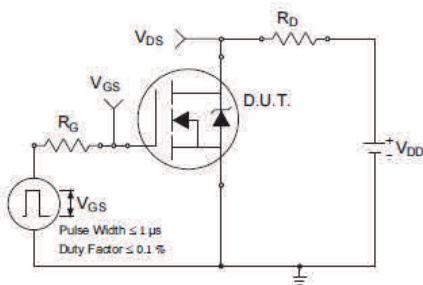

**Fig 20a.** Switching Time Test Circuit

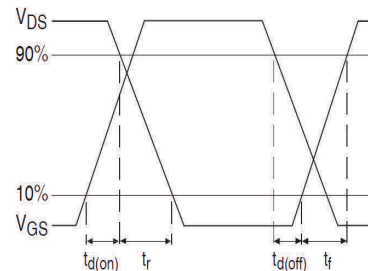

**Fig 20b.** Switching Time Waveforms

**DirectFET® Board Footprint, L8 Outline  
 (Large Size Can, 8-Source Pads)**

Please see DirectFET application note AN-1035 for all details regarding the assembly of DirectFET.  
 This includes all recommendations for stencil and substrate designs.

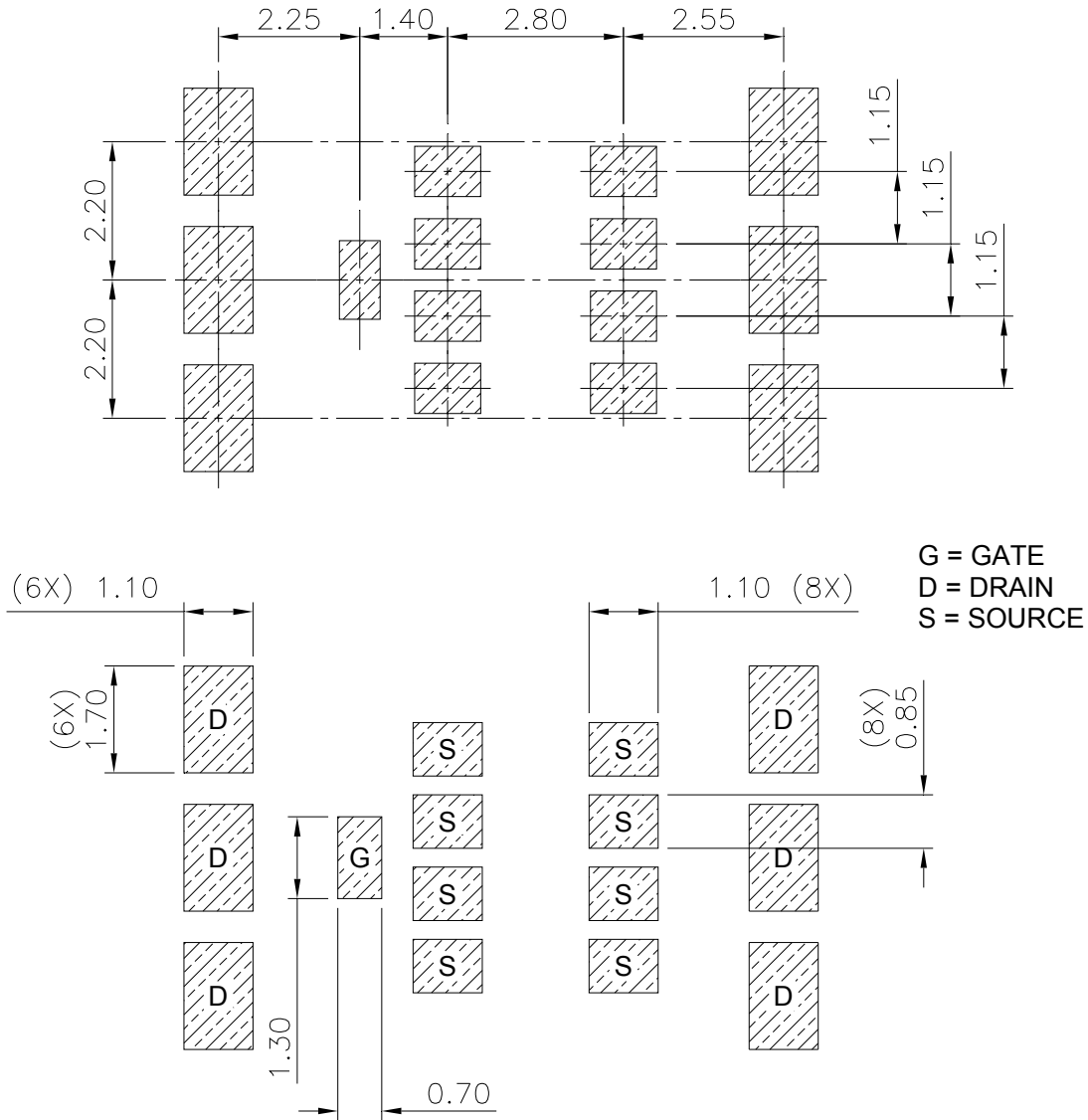

Note: For the most current drawing please refer to IR website at <http://www.irf.com/package/>



**DirectFET® Outline Dimension, L8 Outline  
 (Large Size Can, 8-Source Pads)**

Please see DirectFET® application note AN-1035 for all details regarding the assembly of DirectFET®. This includes all recommendations for stencil and substrate designs.

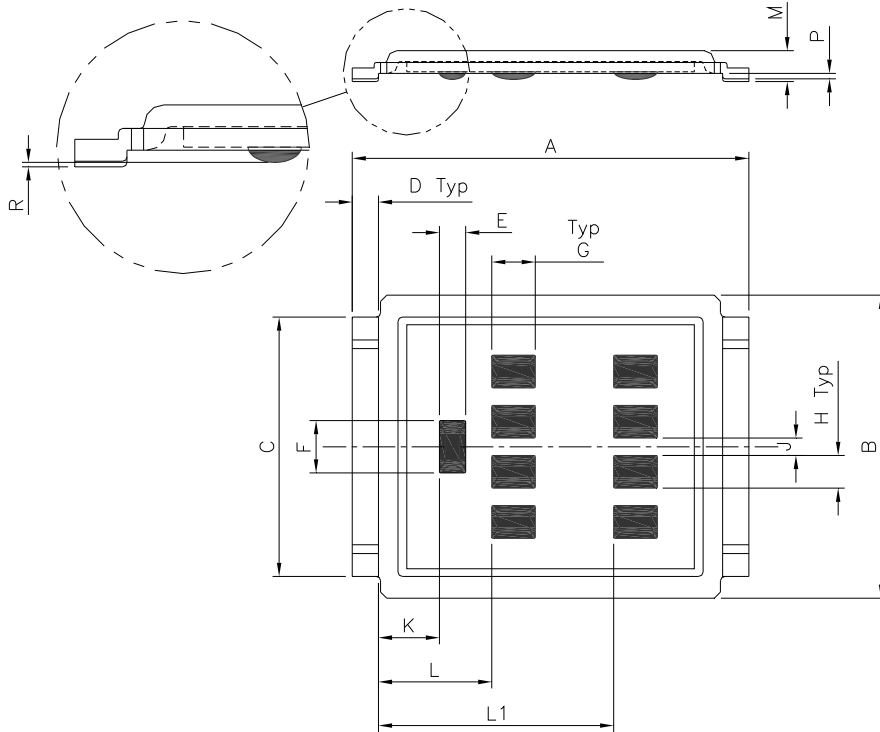

CODE	METRIC		IMPERIAL	
	MIN	MAX	MIN	MAX
A	9.05	9.15	0.356	0.360
B	6.85	7.10	0.270	0.280
C	5.90	6.00	0.232	0.236
D	0.55	0.65	0.022	0.026
E	0.58	0.62	0.023	0.024
F	1.18	1.22	0.046	0.048
G	0.98	1.02	0.039	0.040
H	0.73	0.77	0.029	0.030
J	0.38	0.42	0.015	0.017
K	1.35	1.45	0.053	0.057
L	2.55	2.65	0.100	0.104
L1	5.35	5.45	0.211	0.215
M	0.68	0.74	0.027	0.029
P	0.09	0.17	0.003	0.007
R	0.02	0.08	0.001	0.003

Dimensions are shown in millimeters (inches)

**DirectFET® Part Marking**

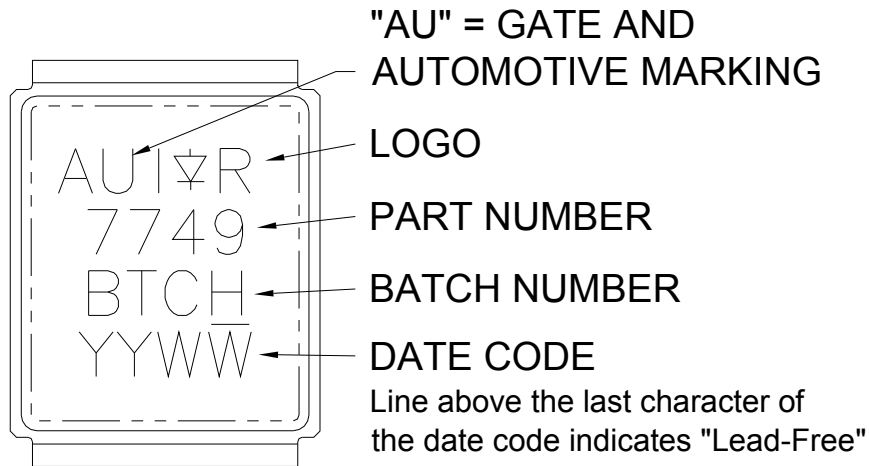

Note: For the most current drawing please refer to IR website at <http://www.irf.com/package/>

**DirectFET® Tape & Reel Dimension (Showing component orientation)**

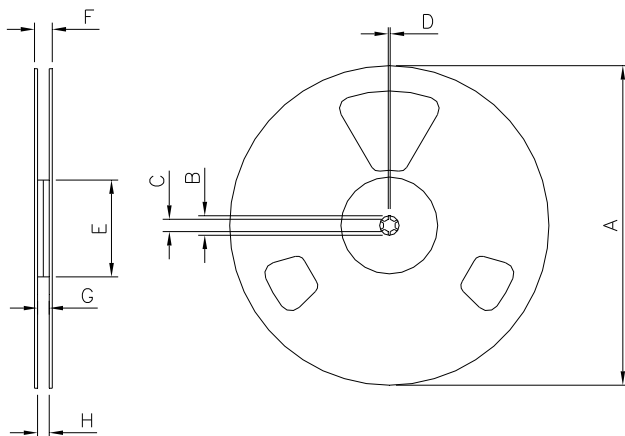

NOTE: Controlling dimensions in mm  
 Std reel quantity is 4000 parts. (ordered as AUIRF7749L2TR).

REEL DIMENSIONS				
STANDARD OPTION (QTY 4000)				
CODE	METRIC		IMPERIAL	
	MIN	MAX	MIN	MAX
A	330.00	N.C	12.992	N.C
B	20.20	N.C	0.795	N.C
C	12.80	13.20	0.504	0.520
D	1.50	N.C	0.059	N.C
E	99.00	100.00	3.900	3.940
F	N.C	22.40	N.C	0.880
G	16.40	18.40	0.650	0.720
H	15.90	19.40	0.630	0.760

**LOADED TAPE FEED DIRECTION**

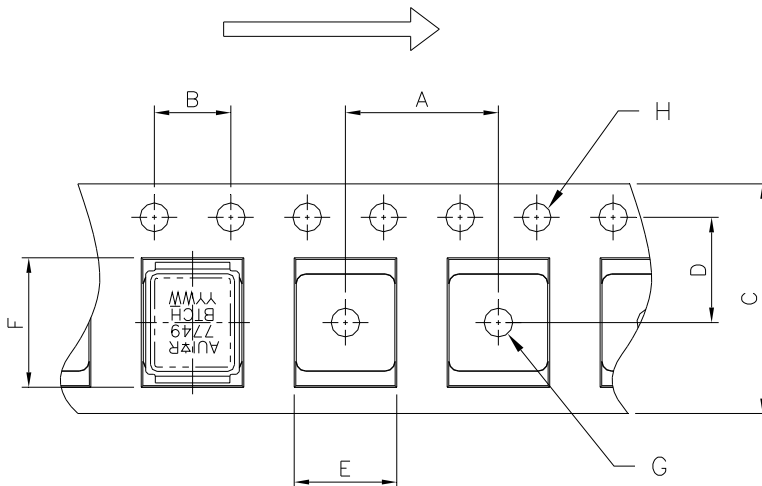

NOTE: CONTROLLING DIMENSIONS IN MM

CODE	METRIC		IMPERIAL	
	MIN	MAX	MIN	MAX
A	11.90	12.10	4.69	0.476
B	3.90	4.10	0.154	0.161
C	15.90	16.30	0.623	0.642
D	7.40	7.60	0.291	0.299
E	7.20	7.40	0.283	0.291
F	9.90	10.10	0.390	0.398
G	1.50	N.C	0.059	N.C
H	1.50	1.60	0.059	0.063

Note: For the most current drawing please refer to IR website at <http://www.irf.com/package/>

**Qualification Information†**

<b>Qualification Level</b>		Automotive (per AEC-Q101)	
		Comments: This part number(s) passed Automotive qualification. IR's Industrial and Consumer qualification level is granted by extension of the higher Automotive level.	
<b>Moisture Sensitivity Level</b>		DirectFET2 L-CAN	MSL1
<b>ESD</b>	Machine Model	Class M4 (+/- 800V) <sup>††</sup>	
		AEC-Q101-002	
	Human Body Model	Class H2 (+/- 4000V) <sup>††</sup>	
		AEC-Q101-001	
<b>RoHS Compliant</b>		Yes	

† Qualification standards can be found at International Rectifier's web site: <http://www.irf.com/>

†† Highest passing voltage.

- ① Click on this section to link to the appropriate technical paper.
- ② Click on this section to link to the Direct FET® Website.
- ③ Surface mounted on 1 in. square Cu board, steady state.
- ④ T<sub>C</sub> measured with thermocouple mounted to top (Drain) of part.
- ⑤ Repetitive rating; pulse width limited by max. junction temperature.

- ⑥ Limited by T<sub>Jmax</sub>, Starting T<sub>J</sub> = 25°C, L = 0.044mH, R<sub>G</sub> = 50Ω, I<sub>AS</sub> = 120A.
- ⑦ Pulse width ≤ 400μs; duty cycle ≤ 2%.
- ⑧ Used double sided cooling, mounting pad with large heat sink.
- ⑨ Mounted on minimum footprint full size board with metalized back and with small clip heat sink.
- ⑩ R<sub>θ</sub> is measured at T<sub>J</sub> of approximately 90°C.

## IMPORTANT NOTICE

Unless specifically designated for the automotive market, International Rectifier Corporation and its subsidiaries (IR) reserve the right to make corrections, modifications, enhancements, improvements, and other changes to its products and services at any time and to discontinue any product or services without notice. Part numbers designated with the "AU" prefix follow automotive industry and / or customer specific requirements with regards to product discontinuance and process change notification. All products are sold subject to IR's terms and conditions of sale supplied at the time of order acknowledgment.

IR warrants performance of its hardware products to the specifications applicable at the time of sale in accordance with IR's standard warranty. Testing and other quality control techniques are used to the extent IR deems necessary to support this warranty. Except where mandated by government requirements, testing of all parameters of each product is not necessarily performed.

IR assumes no liability for applications assistance or customer product design. Customers are responsible for their products and applications using IR components. To minimize the risks with customer products and applications, customers should provide adequate design and operating safeguards.

Reproduction of IR information in IR data books or data sheets is permissible only if reproduction is without alteration and is accompanied by all associated warranties, conditions, limitations, and notices. Reproduction of this information with alterations is an unfair and deceptive business practice. IR is not responsible or liable for such altered documentation. Information of third parties may be subject to additional restrictions.

Resale of IR products or serviced with statements different from or beyond the parameters stated by IR for that product or service voids all express and any implied warranties for the associated IR product or service and is an unfair and deceptive business practice. IR is not responsible or liable for any such statements.

IR products are not designed, intended, or authorized for use as components in systems intended for surgical implant into the body, or in other applications intended to support or sustain life, or in any other application in which the failure of the IR product could create a situation where personal injury or death may occur. Should Buyer purchase or use IR products for any such unintended or unauthorized application, Buyer shall indemnify and hold International Rectifier and its officers, employees, subsidiaries, affiliates, and distributors harmless against all claims, costs, damages, and expenses, and reasonable attorney fees arising out of, directly or indirectly, any claim of personal injury or death associated with such unintended or unauthorized use, even if such claim alleges that IR was negligent regarding the design or manufacture of the product.

Only products certified as military grade by the Defense Logistics Agency (DLA) of the US Department of Defense, are designed and manufactured to meet DLA military specifications required by certain military, aerospace or other applications. Buyers acknowledge and agree that any use of IR products not certified by DLA as military-grade, in applications requiring military grade products, is solely at the Buyer's own risk and that they are solely responsible for compliance with all legal and regulatory requirements in connection with such use.

IR products are neither designed nor intended for use in automotive applications or environments unless the specific IR products are designated by IR as compliant with ISO/TS 16949 requirements and bear a part number including the designation "AU". Buyers acknowledge and agree that, if they use any non-designated products in automotive applications, IR will not be responsible for any failure to meet such requirements.

For technical support, please contact IR's Technical Assistance Center

<http://www.irf.com/technical-info/>

### WORLD HEADQUARTERS:

101 N. Sepulveda Blvd., El Segundo, California 90245

Tel: (310) 252-7105

单击下面可查看定价，库存，交付和生命周期等信息

[>>Infineon Technologies\(英飞凌\)](#)