

MOSFET

600V CoolMOS™ P6 Power Transistor

CoolMOS™ is a revolutionary technology for high voltage power MOSFETs, designed according to the superjunction (SJ) principle and pioneered by Infineon Technologies. CoolMOS™ P6 series combines the experience of the leading SJ MOSFET supplier with high class innovation. The offered devices provide all benefits of a fast switching SJ MOSFET while not sacrificing ease of use. Extremely low switching and conduction losses make switching applications even more efficient, more compact, lighter and cooler.

Features

- Increased MOSFET dv/dt ruggedness
- Extremely low losses due to very low FOM $R_{DS(on)} \cdot Q_g$ and E_{oss}
- Very high commutation ruggedness
- Easy to use/drive
- Pb-free plating, Halogen free mold compound
- Qualified for industrial grade applications according to JEDEC (J-STD20 and JESD22)

Potential applications

PFC stages, hard switching PWM stages and resonant switching stages for e.g. PC Silverbox, Adapter, LCD & PDP TV, Lighting, Server, Telecom and UPS.

Please note: For MOSFET paralleling the use of ferrite beads on the gate or separate totem poles is generally recommended.

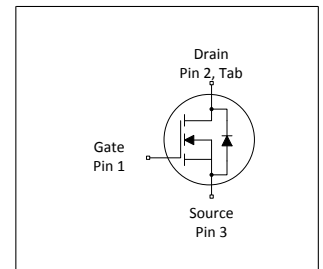
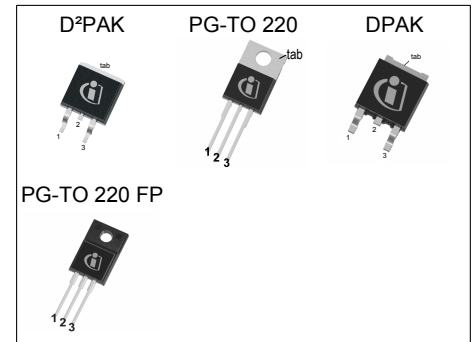

Table 1 Key Performance Parameters

Parameter	Value	Unit
$V_{DS} @ T_{j,max}$	650	V
$R_{DS(on),max}$	380	mΩ
$Q_{g,typ}$	19	nC
$I_{D,pulse}$	29	A
$E_{oss@400V}$	2.7	μJ
Body diode di/dt	500	A/μs

Type / Ordering Code	Package	Marking	Related Links
IPB60R380P6	PG-TO 263-3	6R380P6	see Appendix A
IPP60R380P6	PG-TO 220-3		
IPD60R380P6	PG-TO 252-3		
IPA60R380P6	PG-TO 220 FullPAK		

Table of Contents

Description	1
Maximum ratings	3
Thermal characteristics	4
Electrical characteristics	5
Electrical characteristics diagrams	7
Test Circuits	12
Package Outlines	13
Appendix A	17
Revision History	18
Trademarks	18
Disclaimer	18

600V CoolMOS™ P6 Power Transistor

IPB60R380P6, IPP60R380P6, IPD60R380P6, IPA60R380P6

1 Maximum ratings

at $T_j = 25^\circ\text{C}$, unless otherwise specified

Table 2 Maximum ratings

Parameter	Symbol	Values			Unit	Note / Test Condition
		Min.	Typ.	Max.		
Continuous drain current ¹⁾	I_D	-	-	10.6 6.7	A	$T_C=25^\circ\text{C}$ $T_C=100^\circ\text{C}$
Pulsed drain current ²⁾	$I_{D,pulse}$	-	-	29	A	$T_C=25^\circ\text{C}$
Avalanche energy, single pulse	E_{AS}	-	-	210	mJ	$I_D=1.8\text{A}$; $V_{DD}=50\text{V}$; see table 12
Avalanche energy, repetitive	E_{AR}	-	-	0.32	mJ	$I_D=1.8\text{A}$; $V_{DD}=50\text{V}$; see table 12
Avalanche current, repetitive	I_{AR}	-	-	1.8	A	-
MOSFET dv/dt ruggedness	dv/dt	-	-	100	V/ns	$V_{DS}=0\dots400\text{V}$
Gate source voltage (static)	V_{GS}	-20	-	20	V	static;
Gate source voltage (dynamic)	V_{GS}	-30	-	30	V	AC ($f>1\text{ Hz}$)
Power dissipation (Non FullPAK) TO-220, TO-252, TO-263	P_{tot}	-	-	83	W	$T_C=25^\circ\text{C}$
Power dissipation (FullPAK) TO-220FP	P_{tot}	-	-	31	W	$T_C=25^\circ\text{C}$
Storage temperature	T_{stg}	-55	-	150	$^\circ\text{C}$	-
Operating junction temperature	T_j	-55	-	150	$^\circ\text{C}$	-
Mounting torque (Non FullPAK) TO-220	-	-	-	60	Ncm	M3 and M3.5 screws
Mounting torque (FullPAK) TO-220FP	-	-	-	50	Ncm	M2.5 screws
Continuous diode forward current	I_S	-	-	9.2	A	$T_C=25^\circ\text{C}$
Diode pulse current ²⁾	$I_{S,pulse}$	-	-	29	A	$T_C=25^\circ\text{C}$
Reverse diode dv/dt ³⁾	dv/dt	-	-	15	V/ns	$V_{DS}=0\dots400\text{V}$, $I_{SD}\leq I_S$, $T_j=25^\circ\text{C}$ see table 10
Maximum diode commutation speed	di _f /dt	-	-	500	A/ μs	$V_{DS}=0\dots400\text{V}$, $I_{SD}\leq I_S$, $T_j=25^\circ\text{C}$ see table 10
Insulation withstand voltage for TO-220FP	V_{ISO}	-	-	2500	V	V_{rms} , $T_C=25^\circ\text{C}$, $t=1\text{ min}$

¹⁾ Limited by $T_{j,max}$. Maximum duty cycle $D=0.75$

²⁾ Pulse width t_p limited by $T_{j,max}$

³⁾ Identical low side and high side switch with identical R_θ

2 Thermal characteristics

Table 3 Thermal characteristics (Non FullPAK) TO-220

Parameter	Symbol	Values			Unit	Note / Test Condition
		Min.	Typ.	Max.		
Thermal resistance, junction - case	R_{thJC}	-	-	1.5	°C/W	-
Thermal resistance, junction - ambient	R_{thJA}	-	-	62	°C/W	leaded
Soldering temperature, wavesoldering only allowed at leads	T_{sold}	-	-	260	°C	1.6mm (0.063 in.) from case for 10s

Table 4 Thermal characteristics (FullPAK) TO-220FP

Parameter	Symbol	Values			Unit	Note / Test Condition
		Min.	Typ.	Max.		
Thermal resistance, junction - case	R_{thJC}	-	-	4	°C/W	-
Thermal resistance, junction - ambient	R_{thJA}	-	-	80	°C/W	leaded
Soldering temperature, wavesoldering only allowed at leads	T_{sold}	-	-	260	°C	1.6mm (0.063 in.) from case for 10s

Table 5 Thermal characteristics TO-252, TO-263

Parameter	Symbol	Values			Unit	Note / Test Condition
		Min.	Typ.	Max.		
Thermal resistance, junction - case	R_{thJC}	-	-	1.5	°C/W	-
Thermal resistance, junction - ambient	R_{thJA}	-	-	62	°C/W	device on PCB, minimal footprint
Thermal resistance, junction - ambient for SMD version	R_{thJA}	-	35	45	°C/W	Device on 40mm*40mm*1.5mm epoxy PCB FR4 with 6cm ² (one layer, 70µm thickness) copper area for drain connection and cooling. PCB is vertical without air stream cooling.
Soldering temperature, wave & reflow soldering allowed	T_{sold}	-	-	260	°C	reflow MSL1

600V CoolMOS™ P6 Power Transistor

IPB60R380P6, IPP60R380P6, IPD60R380P6, IPA60R380P6

3 Electrical characteristics

at $T_j=25^\circ\text{C}$, unless otherwise specified

Table 6 Static characteristics

Parameter	Symbol	Values			Unit	Note / Test Condition
		Min.	Typ.	Max.		
Drain-source breakdown voltage	$V_{(BR)DSS}$	600	-	-	V	$V_{GS}=0V, I_D=1mA$
Gate threshold voltage	$V_{(GS)th}$	3.5	4.0	4.5	V	$V_{DS}=V_{GS}, I_D=0.32mA$
Zero gate voltage drain current	I_{DSS}	-	-	1	μA	$V_{DS}=600, V_{GS}=0V, T_j=25^\circ C$ $V_{DS}=600, V_{GS}=0V, T_j=150^\circ C$
Gate-source leakage current	I_{GSS}	-	-	100	nA	$V_{GS}=20V, V_{DS}=0V$
Drain-source on-state resistance	$R_{DS(on)}$	-	0.342 0.889	0.380	Ω	$V_{GS}=10V, I_D=3.8A, T_j=25^\circ C$ $V_{GS}=10V, I_D=3.8A, T_j=150^\circ C$
Gate resistance	R_G	-	7.8	-	Ω	$f=1MHz, \text{open drain}$

Table 7 Dynamic characteristics

Parameter	Symbol	Values			Unit	Note / Test Condition
		Min.	Typ.	Max.		
Input capacitance	C_{iss}	-	877	-	pF	$V_{GS}=0V, V_{DS}=100V, f=1MHz$
Output capacitance	C_{oss}	-	42	-	pF	$V_{GS}=0V, V_{DS}=100V, f=1MHz$
Effective output capacitance, energy related ¹⁾	$C_{o(er)}$	-	33	-	pF	$V_{GS}=0V, V_{DS}=0...400V$
Effective output capacitance, time related ²⁾	$C_{o(tr)}$	-	135	-	pF	$I_D=\text{constant}, V_{GS}=0V, V_{DS}=0...400V$
Turn-on delay time	$t_{d(on)}$	-	12	-	ns	$V_{DD}=400V, V_{GS}=13V, I_D=4.8A, R_G=3.4\Omega; \text{see table 11}$
Rise time	t_r	-	6	-	ns	$V_{DD}=400V, V_{GS}=13V, I_D=4.8A, R_G=3.4\Omega; \text{see table 11}$
Turn-off delay time	$t_{d(off)}$	-	33	-	ns	$V_{DD}=400V, V_{GS}=13V, I_D=4.8A, R_G=3.4\Omega; \text{see table 11}$
Fall time	t_f	-	7	-	ns	$V_{DD}=400V, V_{GS}=13V, I_D=4.8A, R_G=3.4\Omega; \text{see table 11}$

Table 8 Gate charge characteristics

Parameter	Symbol	Values			Unit	Note / Test Condition
		Min.	Typ.	Max.		
Gate to source charge	Q_{GS}	-	5.4	-	nC	$V_{DD}=400V, I_D=4.8A, V_{GS}=0 \text{ to } 10V$
Gate to drain charge	Q_{gd}	-	7	-	nC	$V_{DD}=400V, I_D=4.8A, V_{GS}=0 \text{ to } 10V$
Gate charge total	Q_g	-	19	-	nC	$V_{DD}=400V, I_D=4.8A, V_{GS}=0 \text{ to } 10V$
Gate plateau voltage	$V_{plateau}$	-	6.1	-	V	$V_{DD}=400V, I_D=4.8A, V_{GS}=0 \text{ to } 10V$

¹⁾ $C_{o(er)}$ is a fixed capacitance that gives the same stored energy as C_{oss} while V_{DS} is rising from 0 to 400V

²⁾ $C_{o(tr)}$ is a fixed capacitance that gives the same charging time as C_{oss} while V_{DS} is rising from 0 to 400V

Table 9 Reverse diode characteristics

Parameter	Symbol	Values			Unit	Note / Test Condition
		Min.	Typ.	Max.		
Diode forward voltage	V_{SD}	-	0.9	-	V	$V_{GS}=0V, I_F=4.8A, T_j=25^{\circ}C$
Reverse recovery time	t_{rr}	-	232	-	ns	$V_R=400V, I_F=4.8A, di_F/dt=100A/\mu s$; see table 10
Reverse recovery charge	Q_{rr}	-	2.1	-	μC	$V_R=400V, I_F=4.8A, di_F/dt=100A/\mu s$; see table 10
Peak reverse recovery current	I_{rrm}	-	17	-	A	$V_R=400V, I_F=4.8A, di_F/dt=100A/\mu s$; see table 10

4 Electrical characteristics diagrams

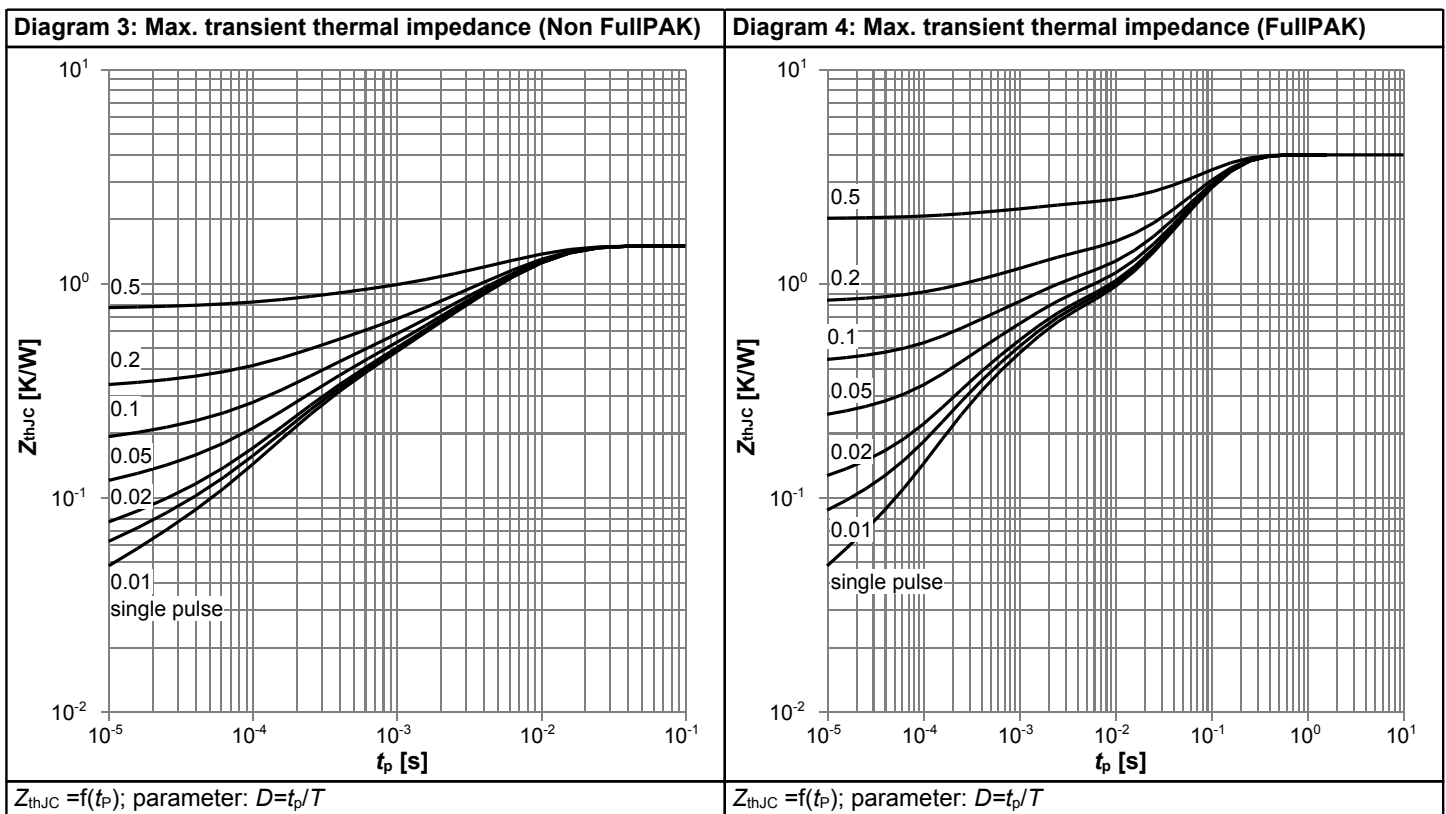
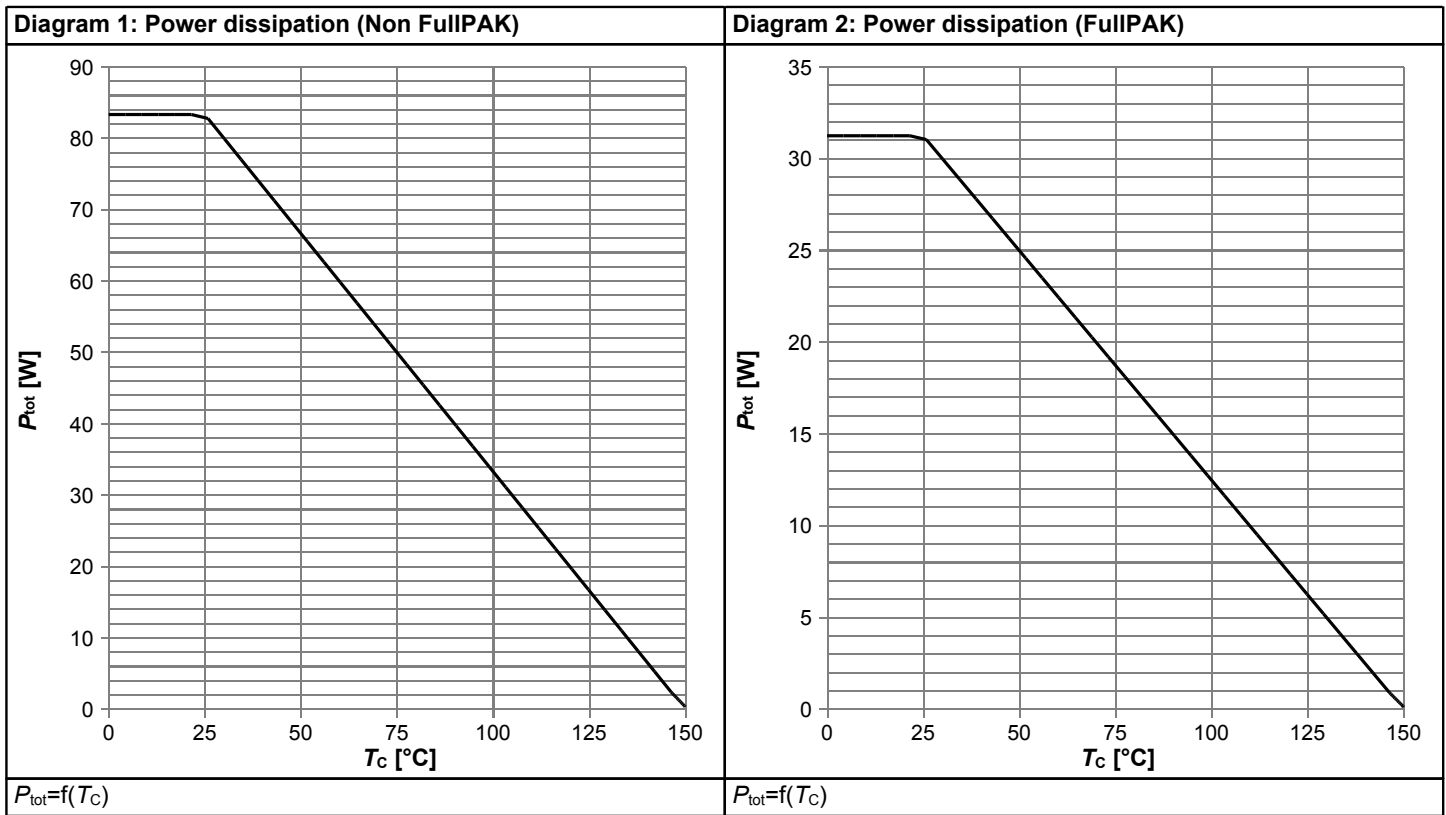

600V CoolMOS™ P6 Power Transistor
 IPB60R380P6, IPP60R380P6, IPD60R380P6, IPA60R380P6

Diagram 5: Safe operating area (Non FullIPAK)

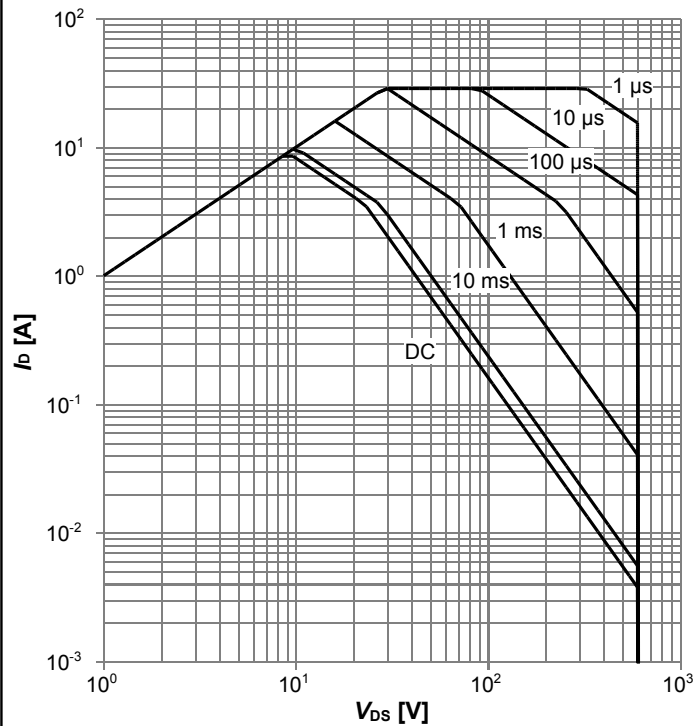

$I_D=f(V_{DS}); T_C=25\text{ }^\circ\text{C}; D=0; \text{parameter: } t_p$

Diagram 6: Safe operating area (FullIPAK)

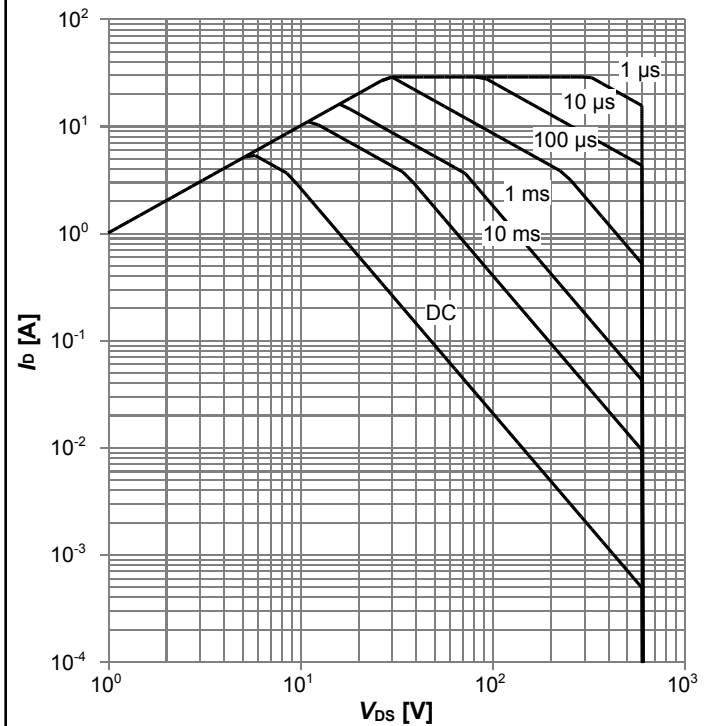

$I_D=f(V_{DS}); T_C=25\text{ }^\circ\text{C}; D=0; \text{parameter: } t_p$

Diagram 7: Safe operating area (Non FullIPAK)

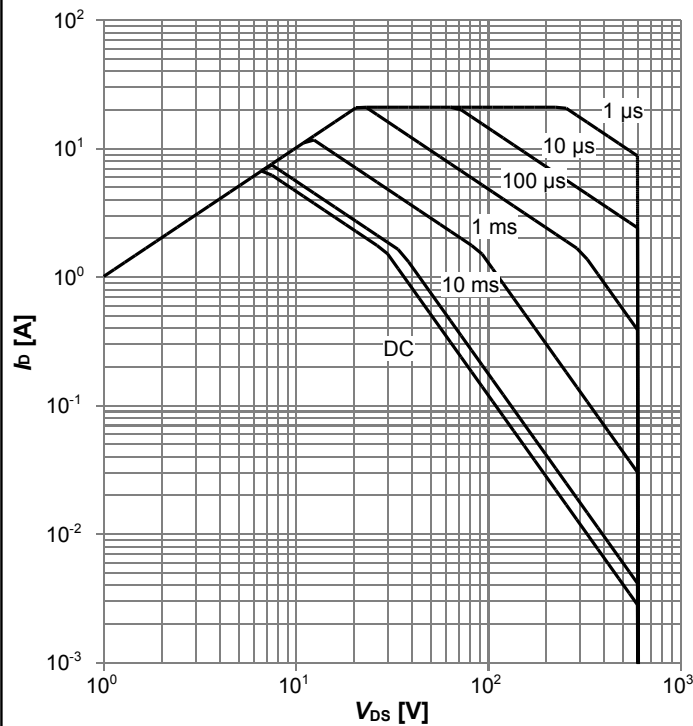

$I_D=f(V_{DS}); T_C=80\text{ }^\circ\text{C}; D=0; \text{parameter: } t_p$

Diagram 8: Safe operating area (FullIPAK)

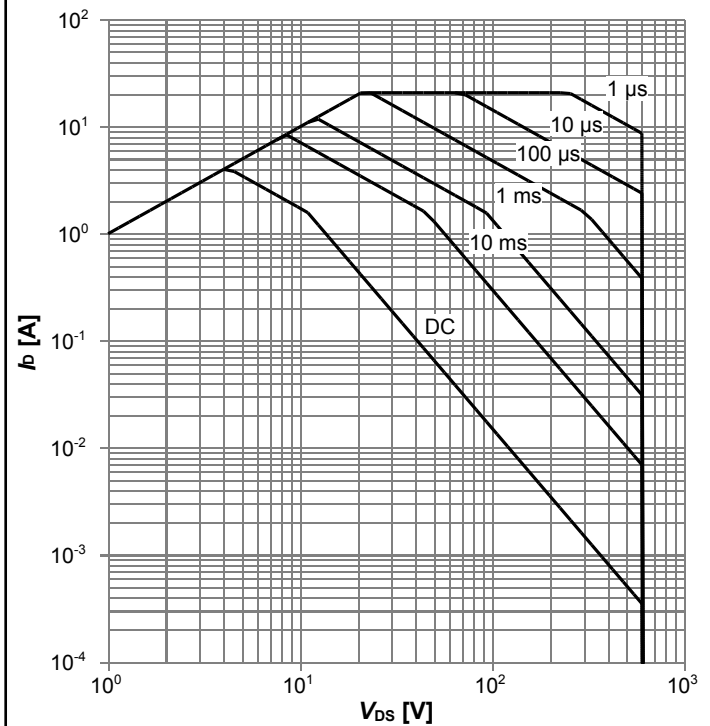

$I_D=f(V_{DS}); T_C=80\text{ }^\circ\text{C}; D=0; \text{parameter: } t_p$

600V CoolMOS™ P6 Power Transistor
IPB60R380P6, IPP60R380P6, IPD60R380P6, IPA60R380P6

Diagram 9: Typ. output characteristics

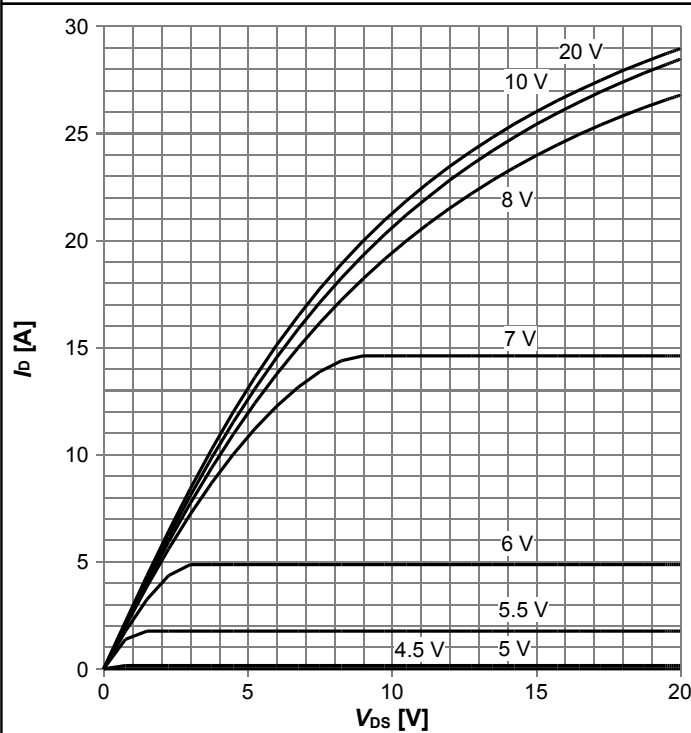

$I_D = f(V_{DS})$; $T_j = 25^\circ\text{C}$; parameter: V_{GS}

Diagram 10: Typ. output characteristics

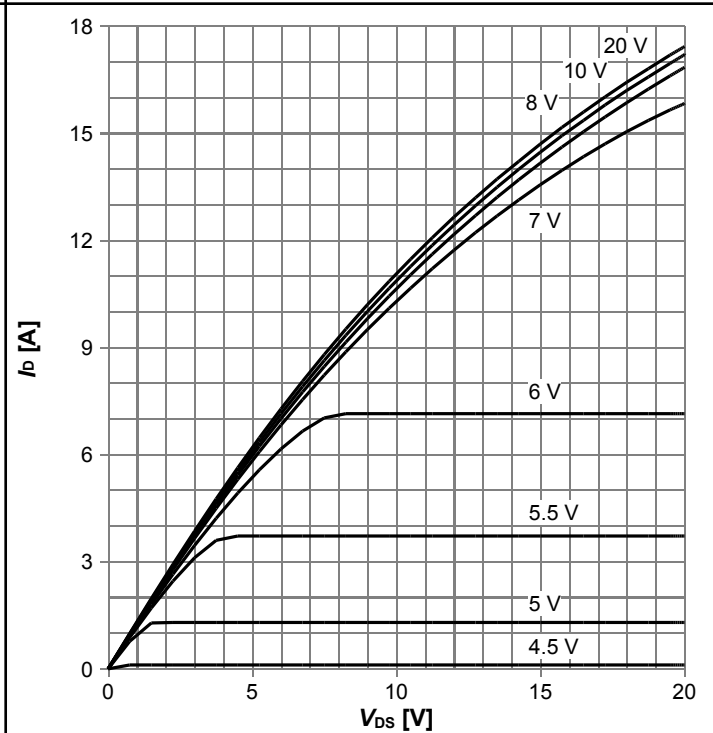

$I_D = f(V_{DS})$; $T_j = 125^\circ\text{C}$; parameter: V_{GS}

Diagram 11: Typ. drain-source on-state resistance

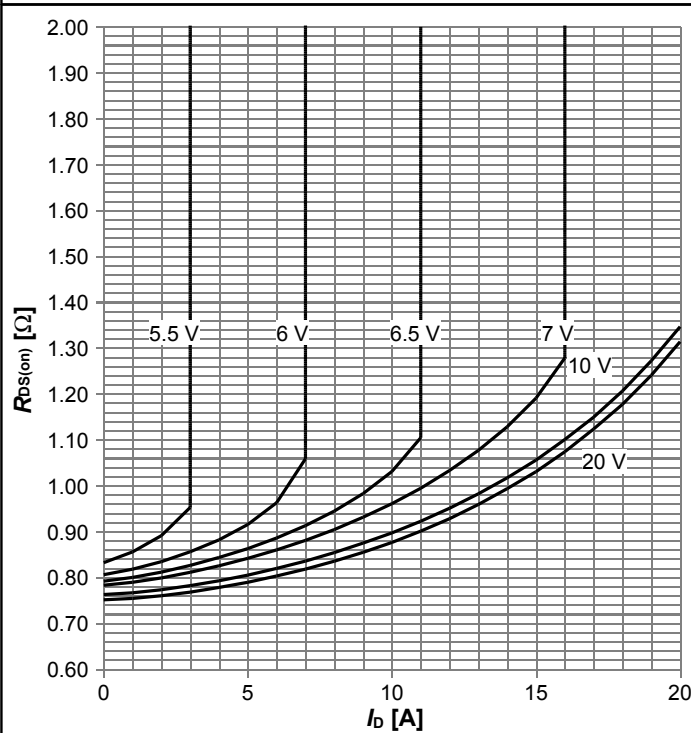

$R_{DS(on)} = f(I_D)$; $T_j = 125^\circ\text{C}$; parameter: V_{GS}

Diagram 12: Drain-source on-state resistance

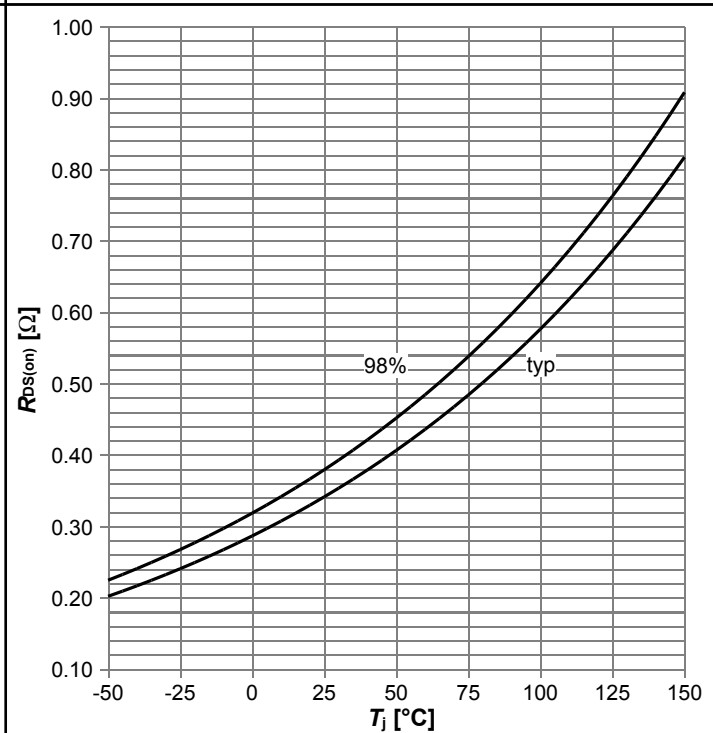

$R_{DS(on)} = f(T_j)$; $I_D = 3.8\text{ A}$; $V_{GS} = 10\text{ V}$

600V CoolMOS™ P6 Power Transistor
 IPB60R380P6, IPP60R380P6, IPD60R380P6, IPA60R380P6

Diagram 13: Typ. transfer characteristics

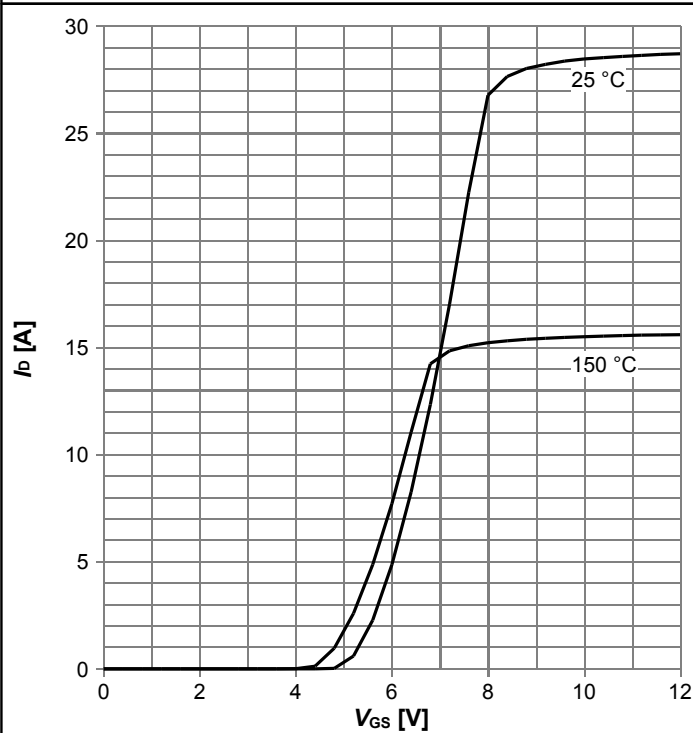

$I_D=f(V_{GS}); V_{DS}=20V; \text{parameter: } T_j$

Diagram 14: Typ. gate charge

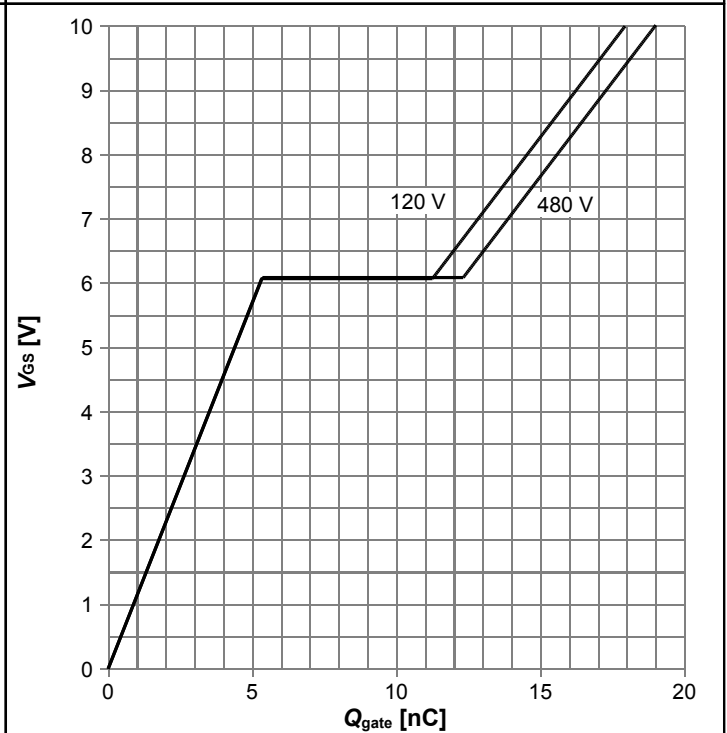

$V_{GS}=f(Q_{gate}); I_D=4.8 \text{ A pulsed}; \text{parameter: } V_{DD}$

Diagram 15: Forward characteristics of reverse diode

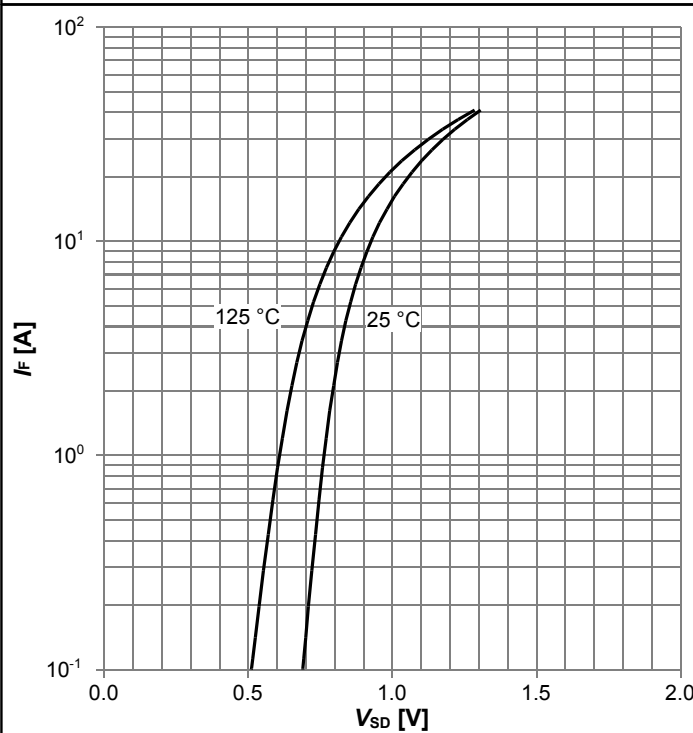

$I_F=f(V_{SD}); \text{parameter: } T_j$

Diagram 16: Avalanche energy

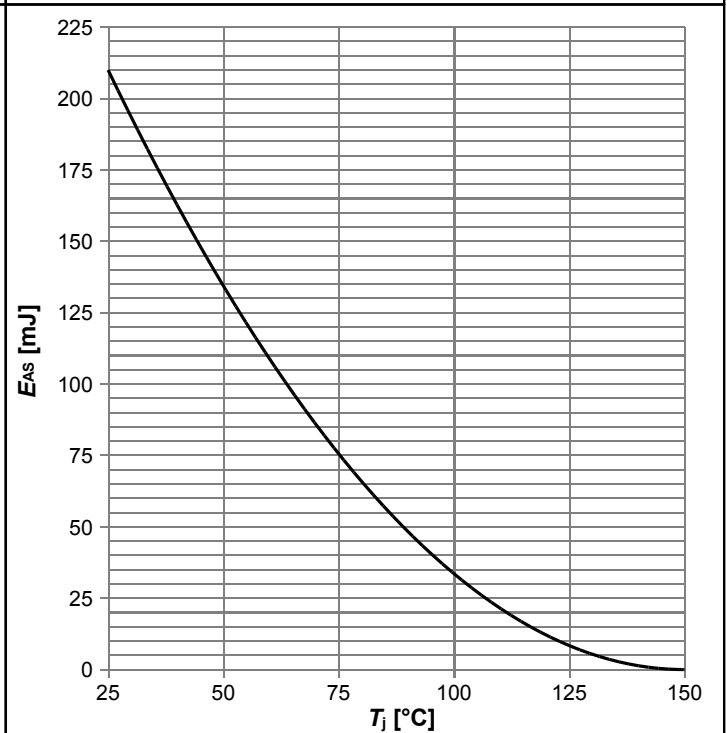

$E_{AS}=f(T_j); I_D=1.8 \text{ A}; V_{DD}=50 \text{ V}$

600V CoolMOS™ P6 Power Transistor
 IPB60R380P6, IPP60R380P6, IPD60R380P6, IPA60R380P6

Diagram 17: Drain-source breakdown voltage

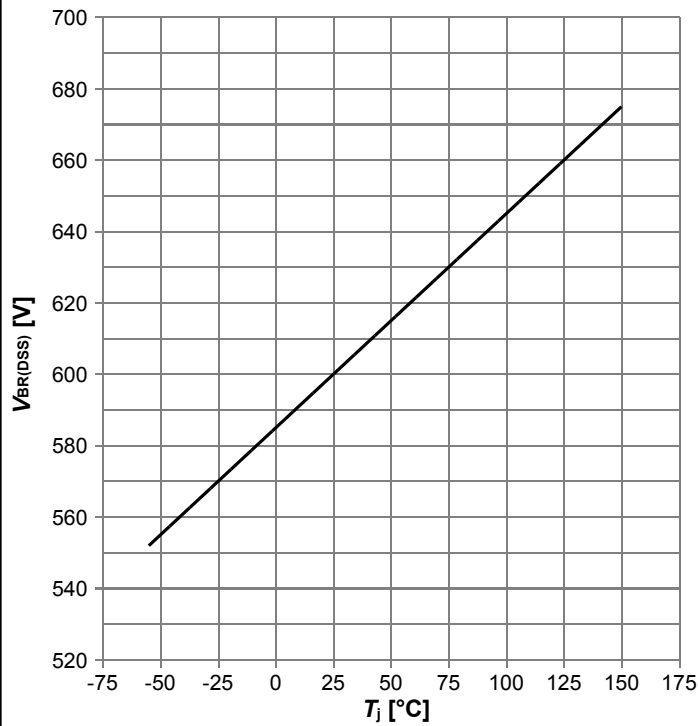

$V_{BR(DSS)}=f(T_j); I_D=1\text{ mA}$

Diagram 18: Typ. capacitances

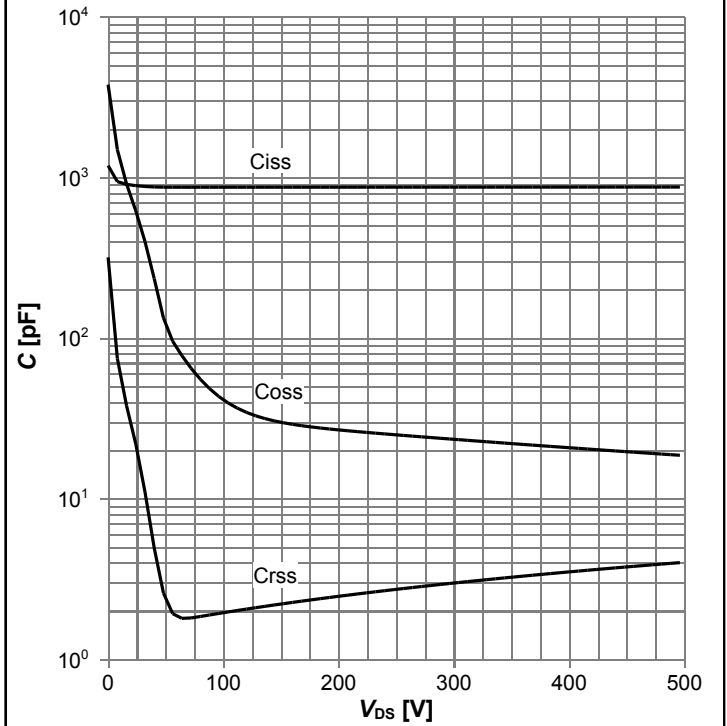

$C=f(V_{DS}); V_{GS}=0\text{ V}; f=1\text{ MHz}$

Diagram 19: Typ. Coss stored energy

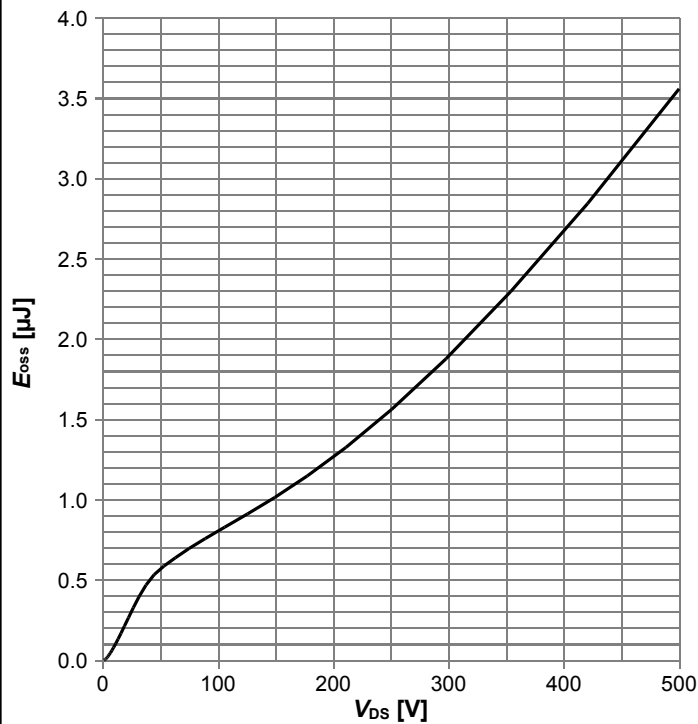

$E_{oss}=f(V_{DS})$

5 Test Circuits

Table 10 Diode characteristics

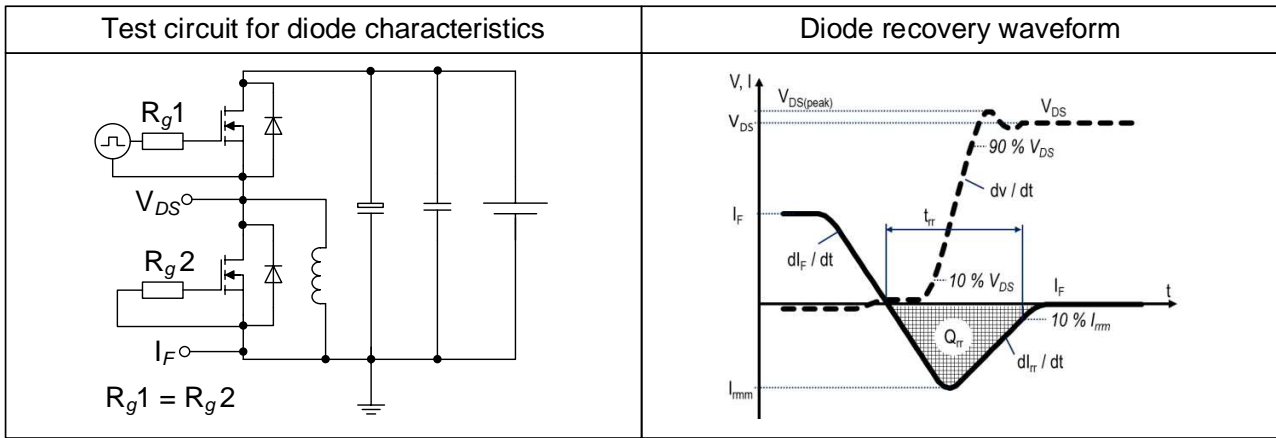

Table 11 Switching times

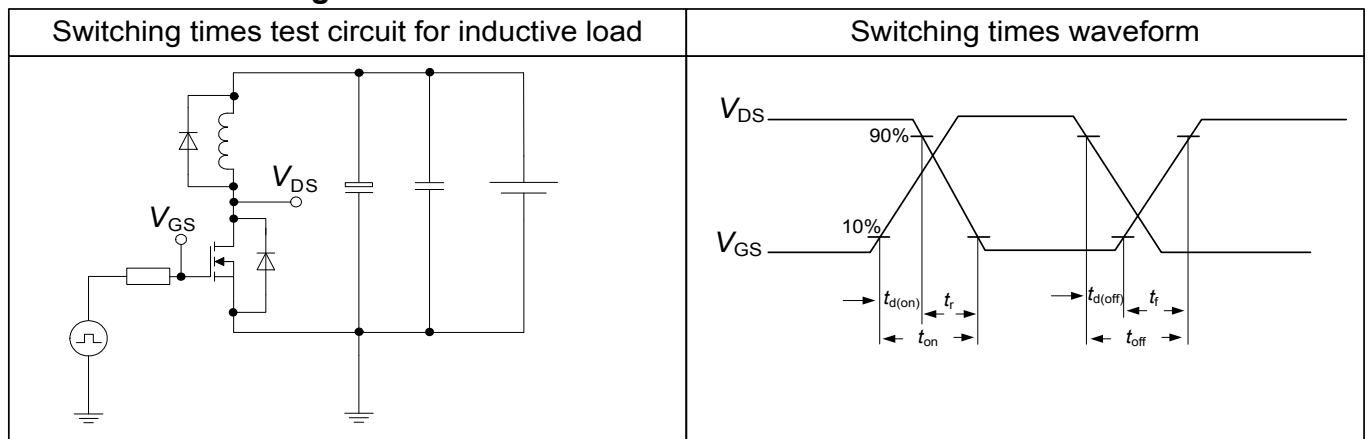
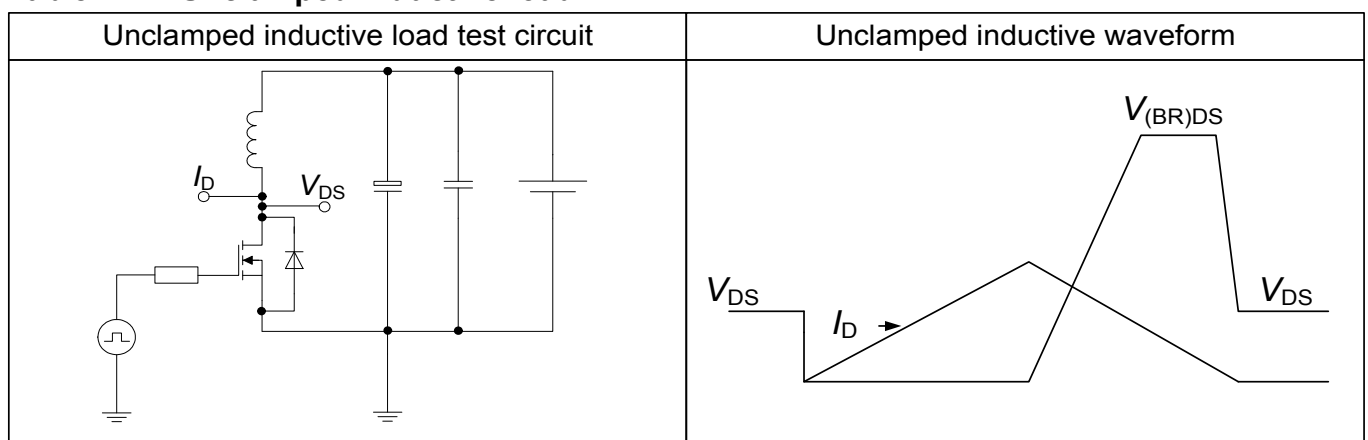

Table 12 Unclamped inductive load



6 Package Outlines

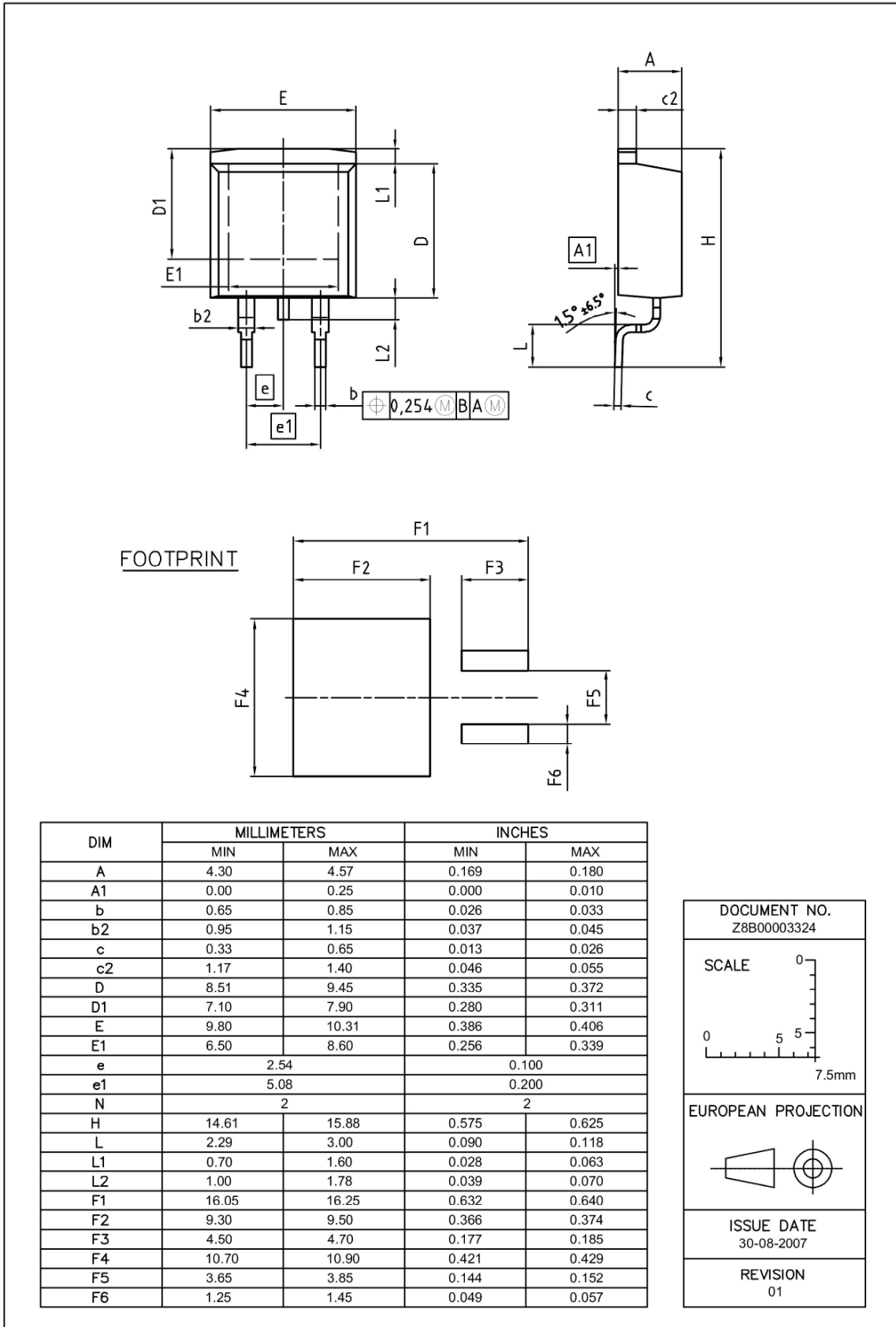

Figure 1 Outline PG-TO 263-3, dimensions in mm/inches

600V CoolMOS™ P6 Power Transistor
IPB60R380P6, IPP60R380P6, IPD60R380P6, IPA60R380P6

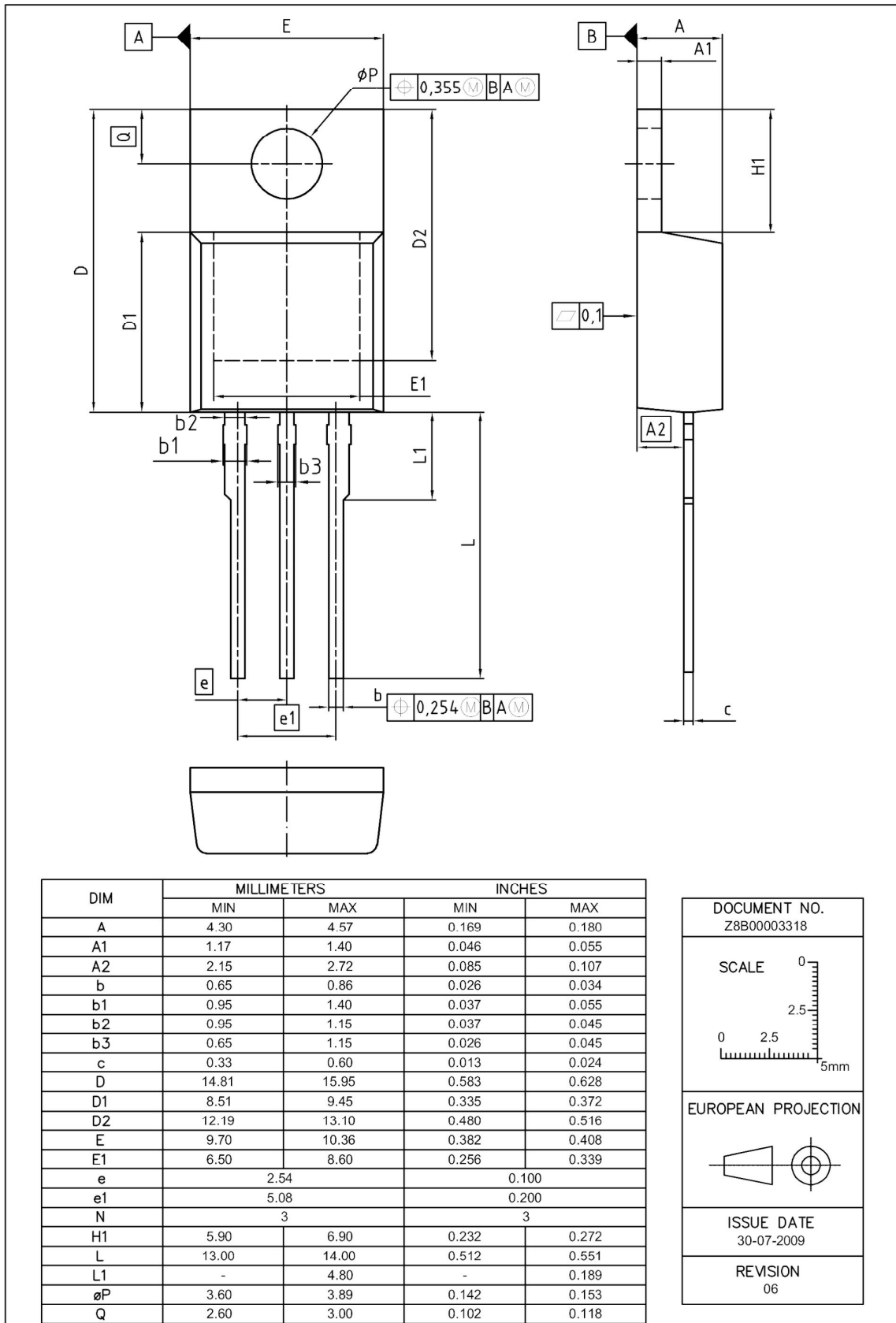

Figure 2 Outline PG-TO 220-3, dimensions in mm/inches

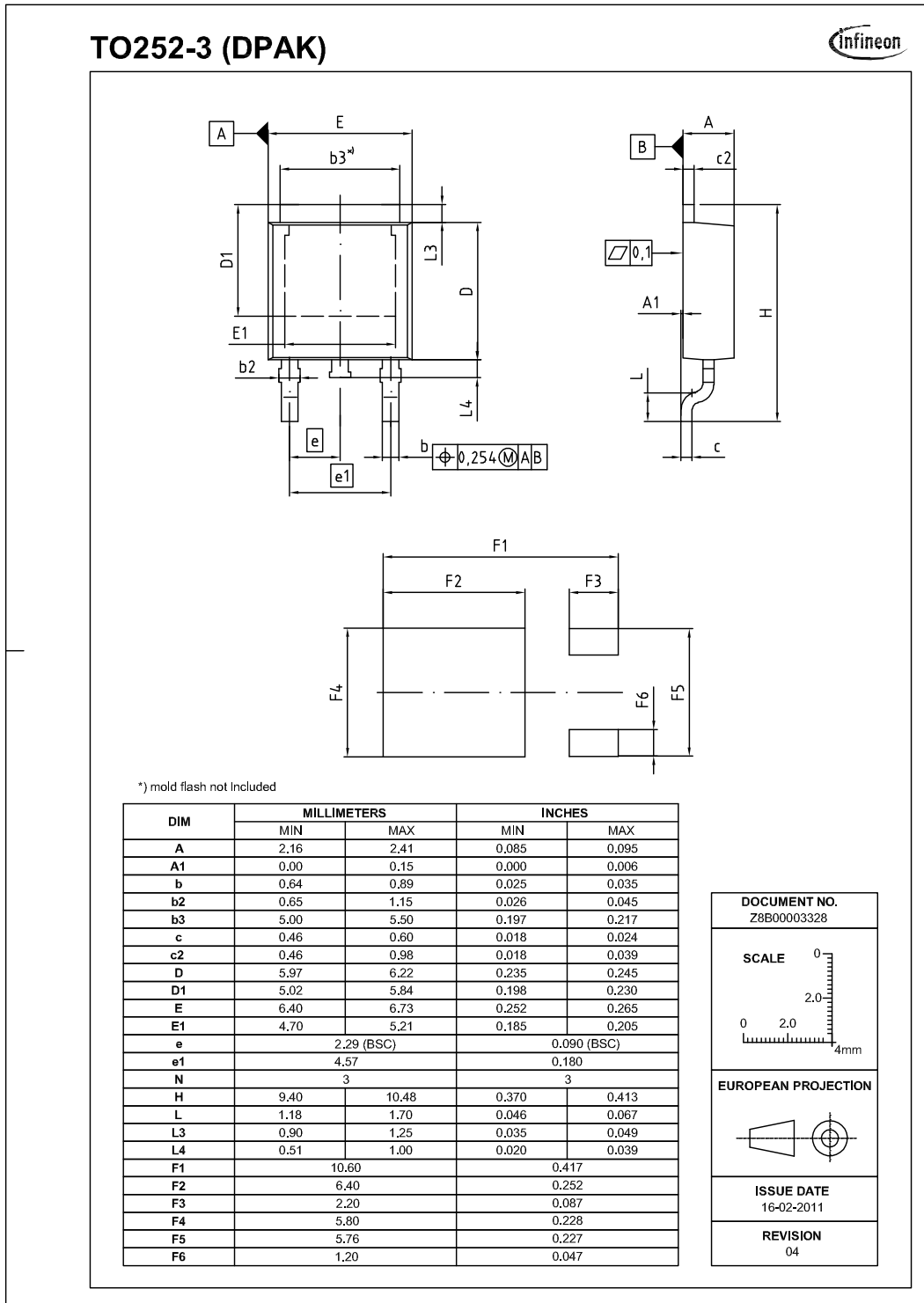
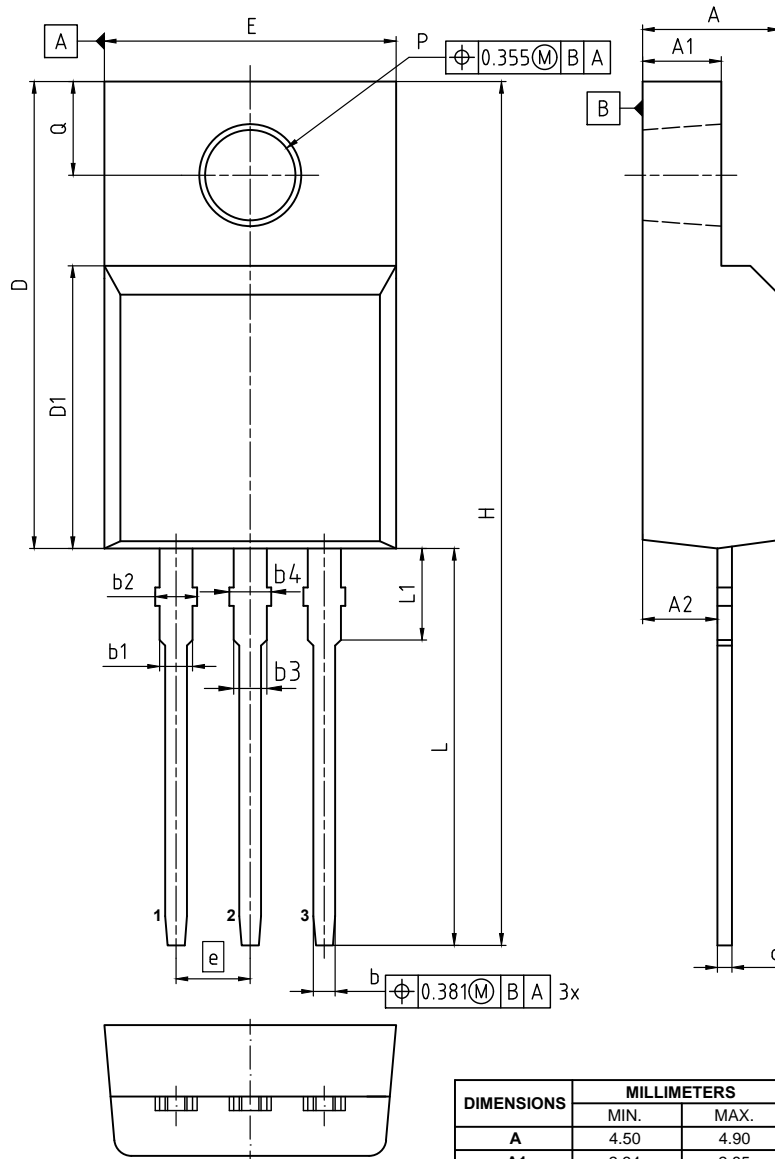

Figure 3 Outline PG-TO 252-3, dimensions in mm/inches

600V CoolMOS™ P6 Power Transistor
IPB60R380P6, IPP60R380P6, IPD60R380P6, IPA60R380P6



NOTES:
 ALL DIMENSIONS REFER TO JEDEC STANDARD TO-281
 AND DOES NOT INCLUDE MOLD FLASH, PROTRUSIONS
 OR GATE BURRS
 GATE BURRS ARE LESS THAN 0.5 mm

DIMENSIONS	MILLIMETERS	
	MIN.	MAX.
A	4.50	4.90
A1	2.34	2.85
A2	2.42	2.86
b	0.65	0.90
b1	0.95	1.38
b2	0.95	1.51
b3	0.65	1.38
b4	0.65	1.51
c	0.40	0.63
D	15.67	16.15
D1	8.97	9.83
E	10.00	10.65
e	2.54	
H	28.70	29.75
L	12.78	13.75
L1	2.83	3.45
øP	3.00	3.30
Q	3.15	3.50

DOCUMENT NO. Z8B00003319
REVISION 07
SCALE 5:1 0 1 2 3 4 5mm
EUROPEAN PROJECTION
ISSUE DATE 27.01.2017

Figure 4 Outline PG-TO 220 FullPAK, dimensions in mm/inches

7 Appendix A

Table 13 Related Links

- IFX CoolMOS™ P6 Webpage: www.infineon.com
- IFX CoolMOS™ P6 application note: www.infineon.com
- IFX CoolMOS™ P6 simulation model: www.infineon.com
- IFX Design tools: www.infineon.com

600V CoolMOS™ P6 Power Transistor

IPB60R380P6, IPP60R380P6, IPD60R380P6, IPA60R380P6

Revision History

IPB60R380P6, IPP60R380P6, IPD60R380P6, IPA60R380P6

Revision: 2017-08-22, Rev. 2.3

Previous Revision

Revision	Date	Subjects (major changes since last revision)
2.0	2013-12-05	Release of final version
2.1	2013-12-05	Release of multi-package datasheet
2.2	2015-07-10	PG-TO 263 package added
2.3	2017-08-22	Updated TO220 Full PAK package drawing on page 16

Trademarks of Infineon Technologies AG

AURIX™, C166™, CanPAK™, CIPOS™, CoolGaN™, CoolMOS™, CoolSET™, CoolSiC™, CORECONTROL™, CROSSAVE™, DAVE™, DI-POL™, DrBlade™, EasyPIM™, EconoBRIDGE™, EconoDUAL™, EconoPACK™, EconoPIM™, EiceDRIVER™, eupec™, FCOS™, HITFET™, HybridPACK™, Infineon™, ISOFACE™, IsoPACK™, i-Wafer™, MIPAQ™, ModSTACK™, my-d™, NovalithIC™, OmniTune™, OPTIGA™, ORIGA™, POWERCODE™, PRIMARION™, PrimePACK™, PrimeSTACK™, PROFET™, PRO-SIL™, RASIC™, REAL3™, ReverSave™, SatRIC™, SIEGET™, SiPMOS™, SmartLEWIS™, SOLID FLASH™, SPOC™, TEMPFET™, thinQ!™, TRENCHSTOP™, TriCore™.

Trademarks updated August 2015

Other Trademarks

All referenced product or service names and trademarks are the property of their respective owners.

We Listen to Your Comments

Any information within this document that you feel is wrong, unclear or missing at all? Your feedback will help us to continuously improve the quality of this document. Please send your proposal (including a reference to this document) to:

erratum@infineon.com

Published by

Infineon Technologies AG
81726 München, Germany
© 2017 Infineon Technologies AG
All Rights Reserved.

Legal Disclaimer

The information given in this document shall in no event be regarded as a guarantee of conditions or characteristics ("Beschaffheitsgarantie").

With respect to any examples, hints or any typical values stated herein and/or any information regarding the application of the product, Infineon Technologies hereby disclaims any and all warranties and liabilities of any kind, including without limitation warranties of non-infringement of intellectual property rights of any third party.

In addition, any information given in this document is subject to customer's compliance with its obligations stated in this document and any applicable legal requirements, norms and standards concerning customer's products and any use of the product of Infineon Technologies in customer's applications.

The data contained in this document is exclusively intended for technically trained staff. It is the responsibility of customer's technical departments to evaluate the suitability of the product for the intended application and the completeness of the product information given in this document with respect to such application.

Information

For further information on technology, delivery terms and conditions and prices please contact your nearest Infineon Technologies Office (www.infineon.com).

Warnings

Due to technical requirements, components may contain dangerous substances. For information on the types in question, please contact the nearest Infineon Technologies Office.

The Infineon Technologies component described in this Data Sheet may be used in life-support devices or systems and/or automotive, aviation and aerospace applications or systems only with the express written approval of Infineon Technologies, if a failure of such components can reasonably be expected to cause the failure of that life-support, automotive, aviation and aerospace device or system or to affect the safety or effectiveness of that device or system. Life support devices or systems are intended to be implanted in the human body or to support and/or maintain and sustain and/or protect human life. If they fail, it is reasonable to assume that the health of the user or other persons may be endangered.

单击下面可查看定价，库存，交付和生命周期等信息

[>>Infineon Technologies\(英飞凌\)](#)

[>>点击查看相关商品](#)