

OptiMOS™ 2 Power-Transistor

Features

- N-channel, normal level
- Excellent gate charge x $R_{DS(on)}$ product (FOM)
- Very low on-resistance $R_{DS(on)}$
- 175 °C operating temperature
- Pb-free lead plating; RoHS compliant
- Qualified according to JEDEC¹⁾ for target application
- Ideal for high-frequency switching and synchronous rectification
- Halogen-free according to IEC61249-2-21 *

Product Summary

V_{DS}	100	V
$R_{DS(on),max}$ (TO252)	16	mΩ
I_D	53	A

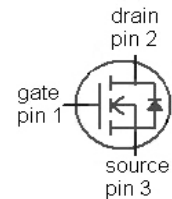

Type	IPB16CN10N G	IPD16CN10N G	IPI16CN10N G	IPP16CN10N G
Package	PG-TO263-3	PG-TO252-3	PG-TO262-3	PG-TO220-3
Marking	16CN10N	16CN10N	16CN10N	16CN10N

Maximum ratings, at $T_j=25\text{ °C}$, unless otherwise specified

Parameter	Symbol	Conditions	Value	Unit
Continuous drain current	I_D	$T_C=25\text{ °C}$	53	A
		$T_C=100\text{ °C}$	38	
Pulsed drain current ²⁾	$I_{D,pulse}$	$T_C=25\text{ °C}$	212	
Avalanche energy, single pulse	E_{AS}	$I_D=53\text{ A}$, $R_{GS}=25\text{ }\Omega$	107	mJ
Reverse diode dv/dt	dv/dt	$I_D=53\text{ A}$, $V_{DS}=80\text{ V}$, $di/dt=100\text{ A}/\mu\text{s}$, $T_{j,max}=175\text{ °C}$	6	kV/ μs
Gate source voltage ³⁾	V_{GS}		± 20	V
Power dissipation	P_{tot}	$T_C=25\text{ °C}$	100	W
Operating and storage temperature	T_j, T_{stg}		-55 ... 175	°C
IEC climatic category; DIN IEC 68-1			55/175/56	

¹⁾J-STD20 and JESD22

²⁾ see figure 3

³⁾ $T_{j,max}=150\text{ °C}$ and duty cycle $D=0.01$ for $V_{GS}<-5\text{ V}$

* Except D-PAK (TO-252)

Parameter	Symbol	Conditions	Values			Unit
			min.	typ.	max.	

Thermal characteristics

Thermal resistance, junction - case	R_{thJC}		-	-	1.5	K/W
Thermal resistance, junction - ambient (TO220, TO262, TO263)	R_{thJA}	minimal footprint	-	-	62	
		6 cm ² cooling area ⁴⁾	-	-	40	
Thermal resistance, junction - ambient (TO252)	R_{thJA}	minimal footprint	-	-	75	
		6 cm ² cooling area ⁴⁾	-	-	50	

Electrical characteristics, at $T_j=25\text{ }^\circ\text{C}$, unless otherwise specified

Static characteristics

Drain-source breakdown voltage	$V_{(BR)DSS}$	$V_{GS}=0\text{ V}, I_D=1\text{ mA}$	100	-	-	V
Gate threshold voltage	$V_{GS(th)}$	$V_{DS}=V_{GS}, I_D=61\text{ }\mu\text{A}$	2	3	4	
Zero gate voltage drain current	I_{DSS}	$V_{DS}=80\text{ V}, V_{GS}=0\text{ V}, T_j=25\text{ }^\circ\text{C}$	-	0.1	1	μA
		$V_{DS}=80\text{ V}, V_{GS}=0\text{ V}, T_j=125\text{ }^\circ\text{C}$	-	10	100	
Gate-source leakage current	I_{GSS}	$V_{GS}=20\text{ V}, V_{DS}=0\text{ V}$	-	1	100	nA
Drain-source on-state resistance	$R_{DS(on)}$	$V_{GS}=10\text{ V}, I_D=53\text{ A},$ (TO252)	-	12.2	16	$\text{m}\Omega$
		$V_{GS}=10\text{ V}, I_D=53\text{ A},$ (TO262)	-	12.4	16.2	
		$V_{GS}=10\text{ V}, I_D=53\text{ A},$ (TO220, TO263)	-	12.7	16.5	
Gate resistance	R_G		-	1.2	-	Ω
Transconductance	g_{fs}	$ V_{DS} >2 I_D R_{DS(on)max},$ $I_D=53\text{ A}$	33	65	-	S

⁴⁾ Device on 40 mm x 40 mm x 1.5 mm epoxy PCB FR4 with 6 cm² (one layer, 70 μm thick) copper area for drain connection. PCB is vertical in still air.

Parameter	Symbol	Conditions	Values			Unit
			min.	typ.	max.	

Dynamic characteristics

Input capacitance	C_{iss}	$V_{GS}=0\text{ V}, V_{DS}=50\text{ V},$ $f=1\text{ MHz}$	-	2420	3220	pF
Output capacitance	C_{oss}		-	364	484	
Reverse transfer capacitance	C_{rss}		-	23	35	
Turn-on delay time	$t_{d(on)}$	$V_{DD}=50\text{ V}, V_{GS}=10\text{ V},$ $I_D=26.5\text{ A}, R_G=1.6\ \Omega$	-	15	22	ns
Rise time	t_r		-	14	21	
Turn-off delay time	$t_{d(off)}$		-	27	41	
Fall time	t_f		-	7	11	

Gate Charge Characteristics⁵⁾

Gate to source charge	Q_{gs}	$V_{DD}=50\text{ V}, I_D=53\text{ A},$ $V_{GS}=0\text{ to }10\text{ V}$	-	13	18	nC
Gate to drain charge	Q_{gd}		-	9	13	
Switching charge	Q_{sw}		-	15	21	
Gate charge total	Q_g		-	36	48	
Gate plateau voltage	$V_{plateau}$		-	5.6	-	V
Output charge	Q_{oss}	$V_{DD}=50\text{ V}, V_{GS}=0\text{ V}$	-	38	51	nC

Reverse Diode

Diode continuous forward current	I_S	$T_C=25\text{ }^\circ\text{C}$	-	-	53	A
Diode pulse current	$I_{S,pulse}$		-	-	212	
Diode forward voltage	V_{SD}	$V_{GS}=0\text{ V}, I_F=53\text{ A},$ $T_j=25\text{ }^\circ\text{C}$	-	1	1.2	V
Reverse recovery time	t_{rr}	$V_R=50\text{ V}, I_F=I_S,$ $di_F/dt=100\text{ A}/\mu\text{s}$	-	110	-	ns
Reverse recovery charge	Q_{rr}		-	215	-	nC

⁵⁾ See figure 16 for gate charge parameter definition

1 Power dissipation

$P_{tot}=f(T_C)$

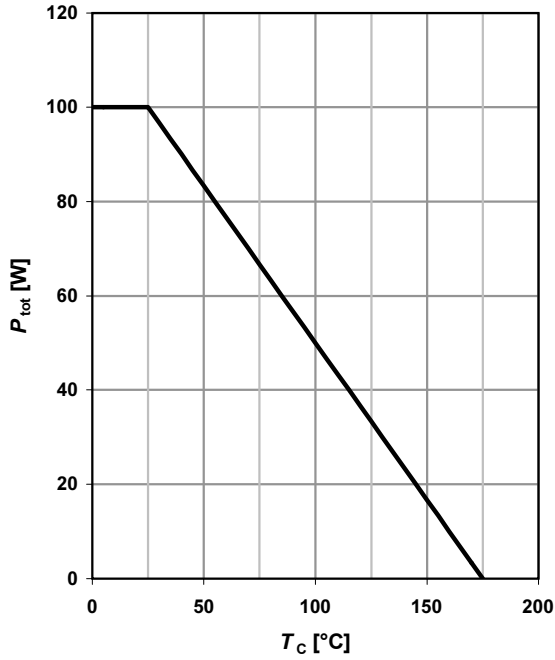

2 Drain current

$I_D=f(T_C); V_{GS} \geq 10\text{ V}$

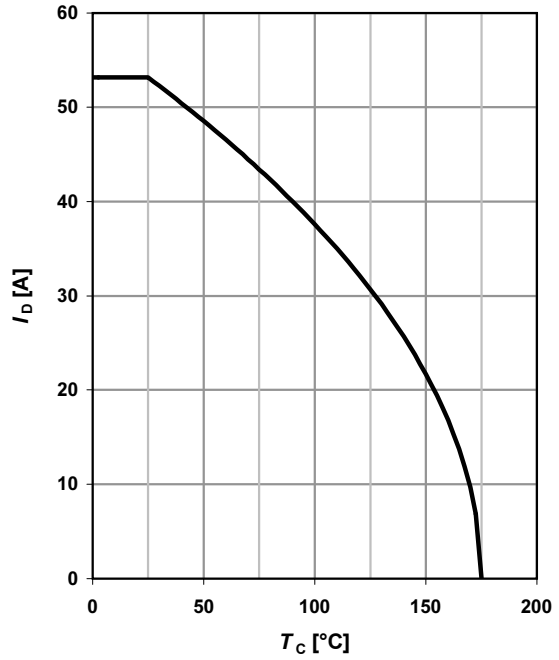

3 Safe operating area

$I_D=f(V_{DS}); T_C=25\text{ °C}; D=0$

parameter: t_p

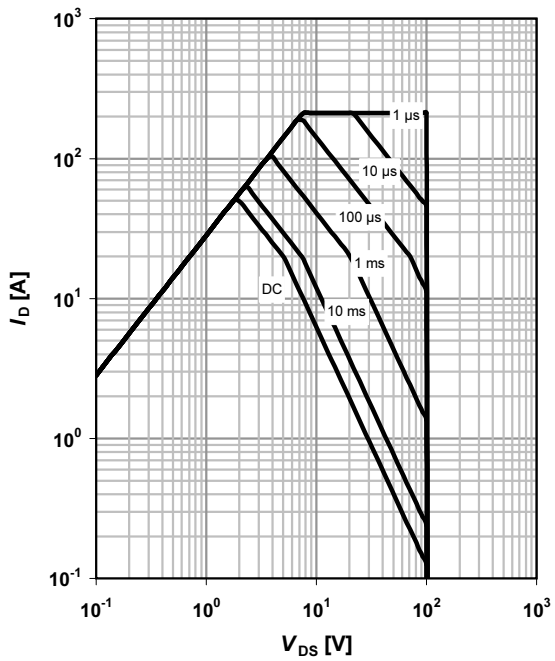

4 Max. transient thermal impedance

$Z_{thJC}=f(t_p)$

parameter: $D=t_p/T$

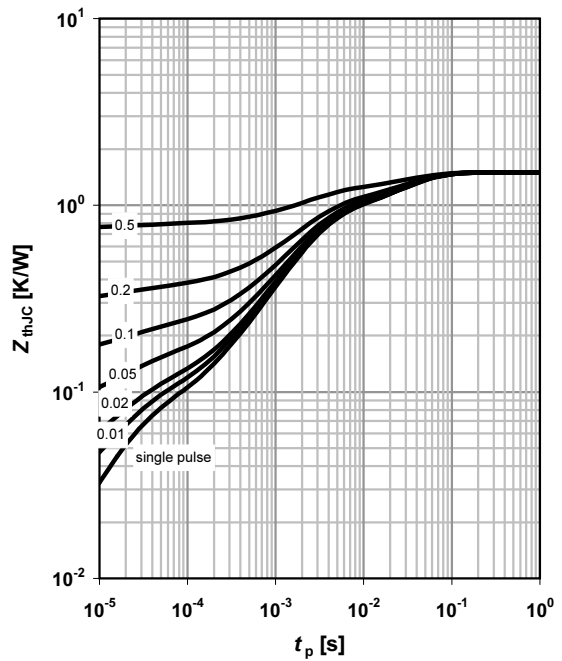

5 Typ. output characteristics

$$I_D = f(V_{DS}); T_j = 25\text{ }^\circ\text{C}$$

parameter: V_{GS}

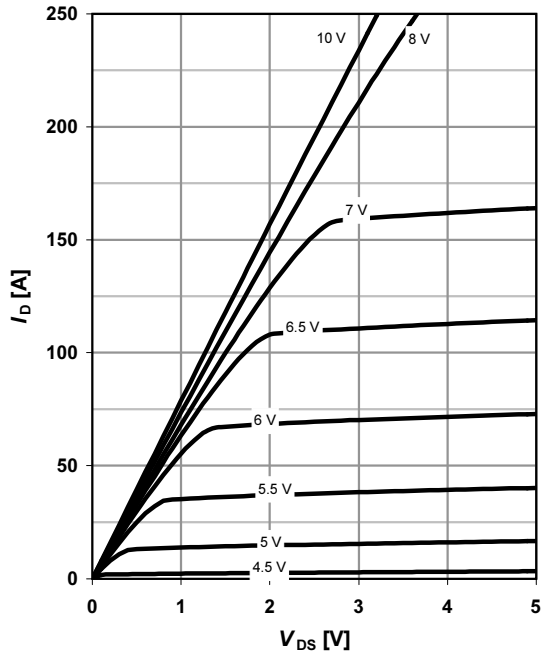

6 Typ. drain-source on resistance

$$R_{DS(on)} = f(I_D); T_j = 25\text{ }^\circ\text{C}$$

parameter: V_{GS}

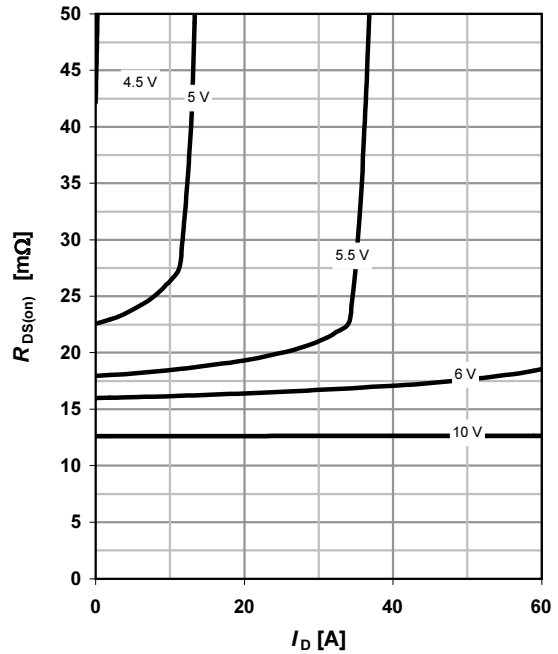

7 Typ. transfer characteristics

$$I_D = f(V_{GS}); |V_{DS}| > 2|I_D|R_{DS(on)max}$$

parameter: T_j

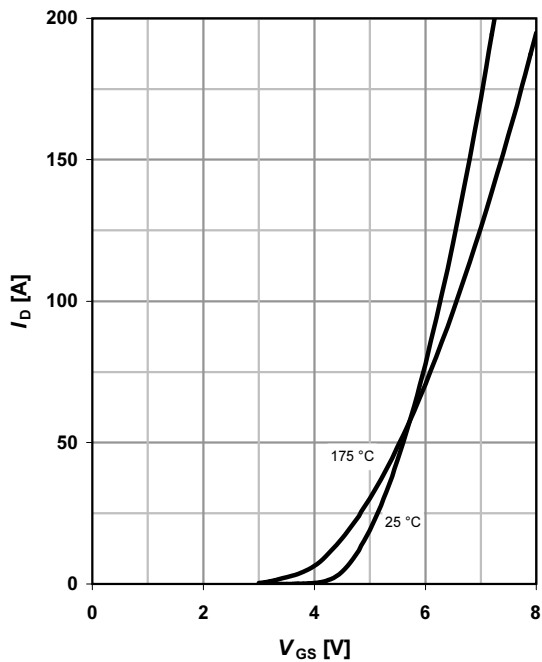

8 Typ. forward transconductance

$$g_{fs} = f(I_D); T_j = 25\text{ }^\circ\text{C}$$

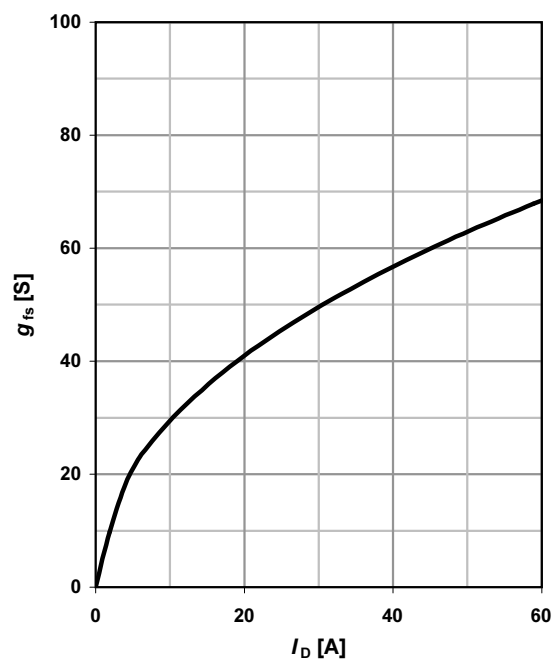

9 Drain-source on-state resistance

$R_{DS(on)} = f(T_j); I_D = 53 \text{ A}; V_{GS} = 10 \text{ V}$

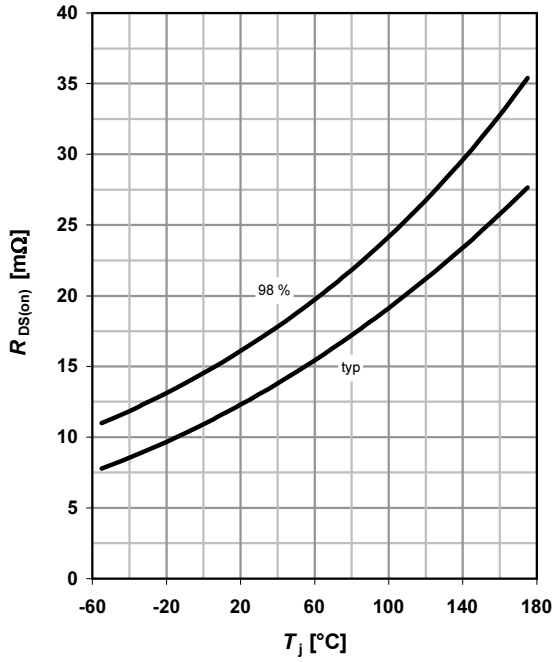

10 Typ. gate threshold voltage

$V_{GS(th)} = f(T_j); V_{GS} = V_{DS}$

parameter: I_D

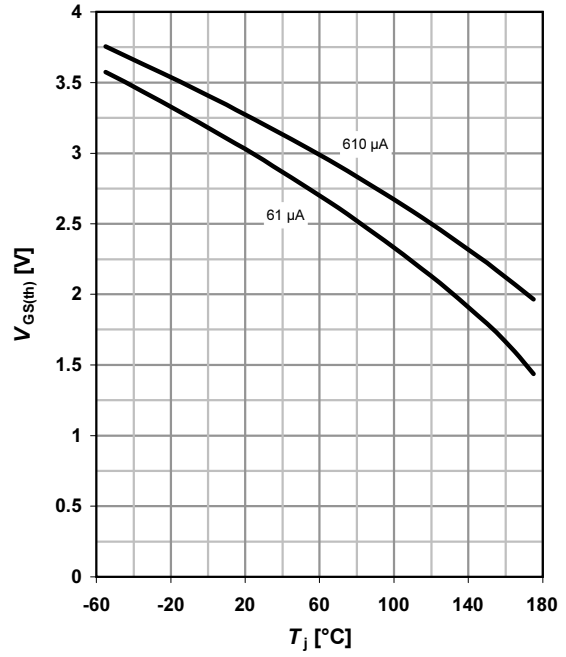

11 Typ. capacitances

$C = f(V_{DS}); V_{GS} = 0 \text{ V}; f = 1 \text{ MHz}$

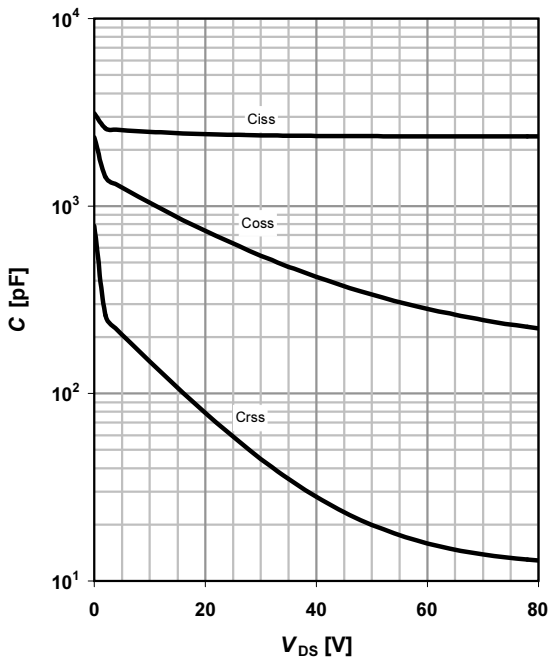

12 Forward characteristics of reverse diode

$I_F = f(V_{SD})$

parameter: T_j

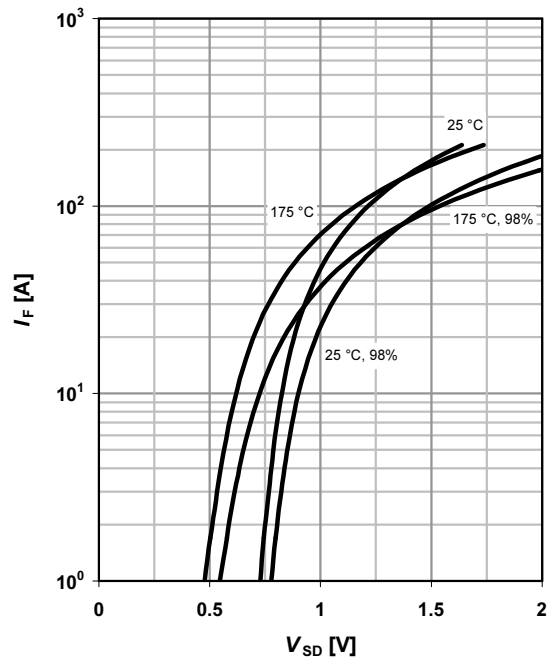

13 Avalanche characteristics

$$I_{AS} = f(t_{AV}); R_{GS} = 25 \Omega$$

parameter: $T_{j(\text{start})}$

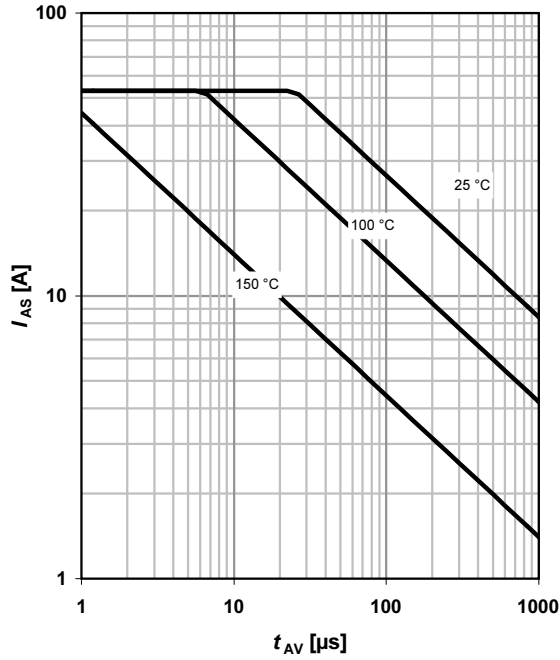

14 Typ. gate charge

$$V_{GS} = f(Q_{\text{gate}}); I_D = 53 \text{ A pulsed}$$

parameter: V_{DD}

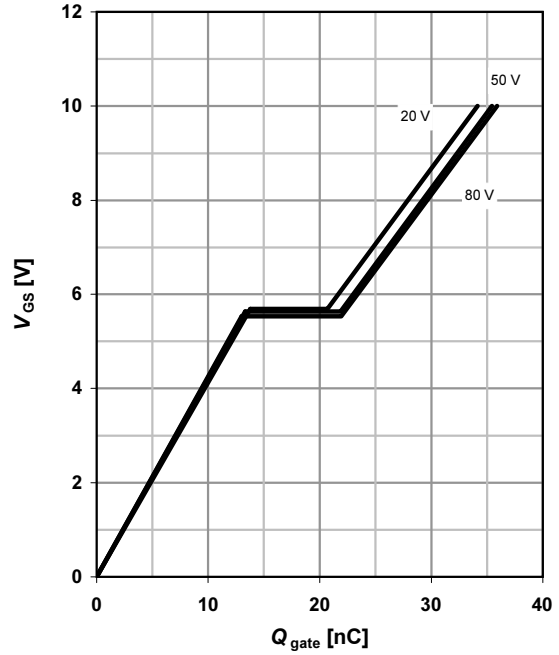

15 Drain-source breakdown voltage

$$V_{BR(DSS)} = f(T_j); I_D = 1 \text{ mA}$$

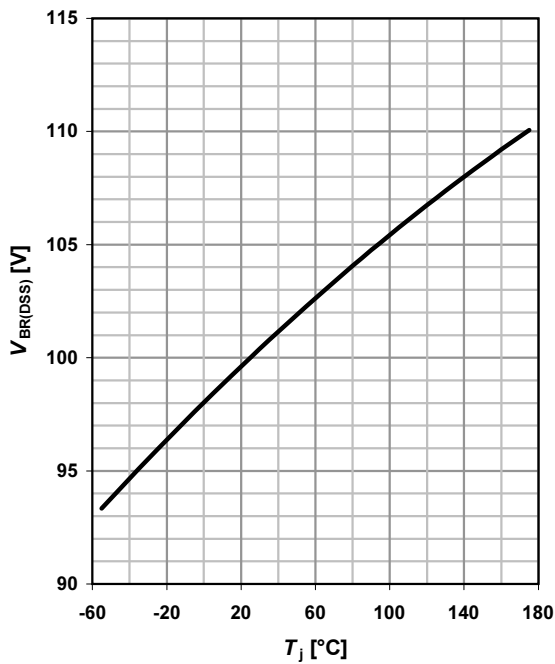

16 Gate charge waveforms

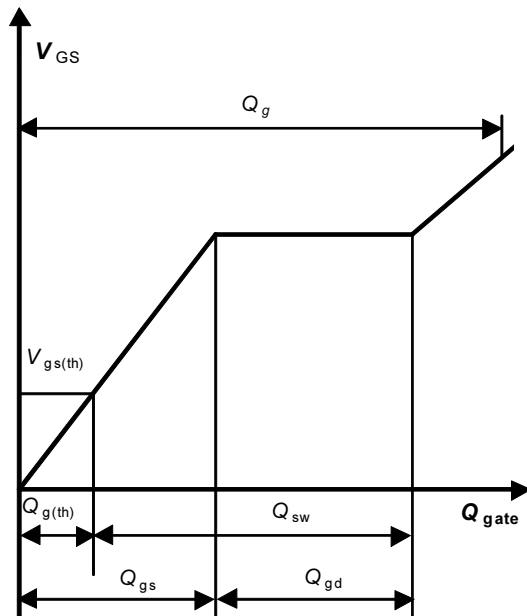

PG-TO220-3: Outline

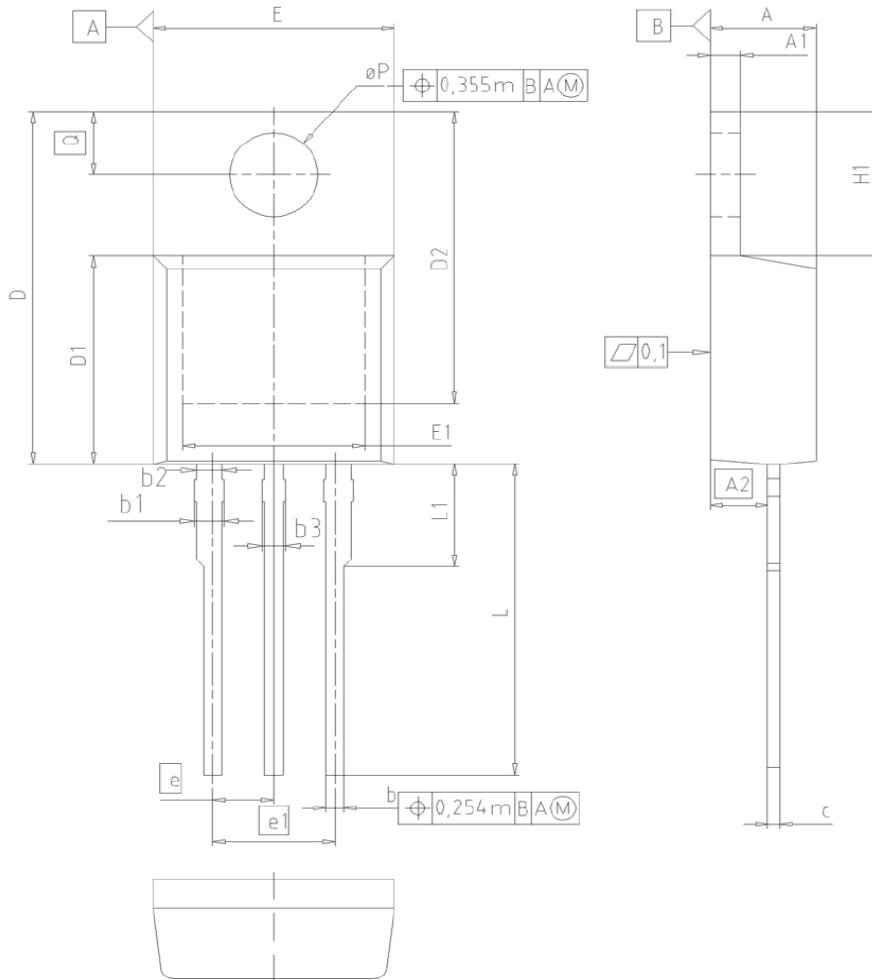

DIM	MILLIMETERS		INCHES	
	MIN	MAX	MIN	MAX
A	4.30	4.57	0.169	0.180
A1	1.17	1.40	0.046	0.055
A2	2.15	2.72	0.085	0.107
b	0.65	0.86	0.026	0.034
b1	0.95	1.40	0.037	0.055
b2	0.95	1.15	0.037	0.045
b3	0.65	1.15	0.026	0.045
c	0.33	0.50	0.013	0.024
D	14.81	15.95	0.583	0.628
D1	8.51	9.45	0.335	0.372
D2	12.19	13.10	0.480	0.516
E	9.70	10.36	0.382	0.408
E1	6.50	8.50	0.256	0.339
e	2.54		0.100	
e1	5.08		0.200	
N	3		3	
H1	5.90	6.90	0.232	0.272
L	13.00	14.00	0.512	0.551
L1	-	4.80	-	0.189
øP	3.60	3.89	0.142	0.153
Q	2.60	3.00	0.102	0.118

DOCUMENT NO.
Z8B00003318

SCALE

EUROPEAN PROJECTION

ISSUE DATE
23-08-2007

REVISION
05

PG-TO262-3-1 (I²PAK)

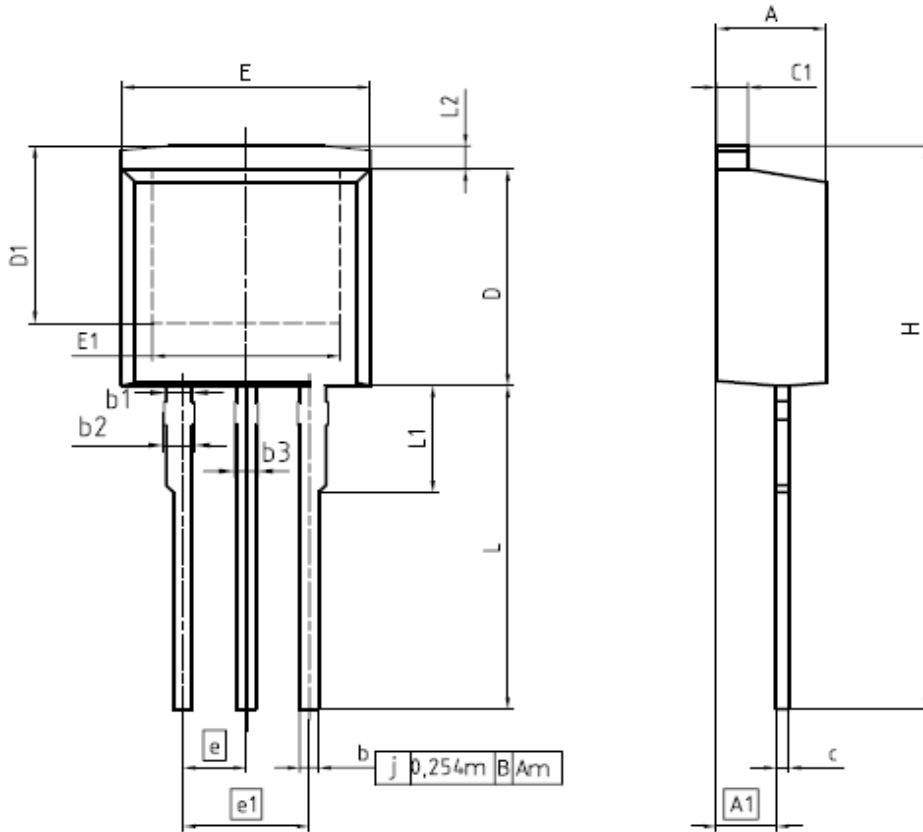

DIM	MILLIMETERS		INCHES	
	MIN	MAX	MIN	MAX
A	4,300	4,572	0,169	0,180
A1	2,150	2,718	0,085	0,107
b	0,650	0,864	0,026	0,034
b1	0,950	1,093	0,037	0,043
b2	0,950	1,400	0,037	0,055
b3	0,650	1,118	0,026	0,044
c	0,330	0,600	0,013	0,024
c1	1,170	1,400	0,046	0,055
D	6,509	9,450	0,335	0,372
D1	6,900	-	0,272	-
E	9,700	10,363	0,382	0,408
E1	6,500	8,600	0,256	0,339
e	2,540		0,100	
e1	5,080		0,200	
N	3		3	
L	13,000	14,000	0,512	0,551
L1	-	4,800	-	0,189
L2	-	1,727	-	0,068

REFERENCE
JEDEC TO262

SCALE

EUROPEAN PROJECTION

ISSUE DATE
05-05-2006

FILE
TO262_1

PG-TO-263 (D²-Pak)

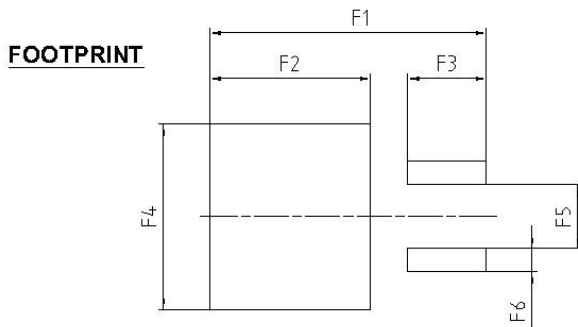
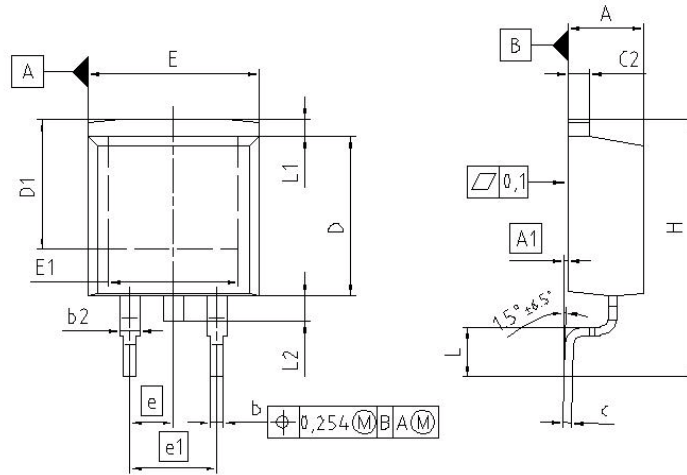

DIM	MILLIMETERS		INCHES	
	MIN	MAX	MIN	MAX
A	4.300	4.572	0.169	0.180
A1	0.000	0.254	0.000	0.010
b	0.650	0.850	0.026	0.033
b2	0.950	1.321	0.037	0.052
c	0.330	0.650	0.013	0.026
c2	0.170	1.400	0.046	0.055
D	8.509	9.450	0.335	0.372
D1	7.100	-	0.280	-
E	9.800	10.312	0.386	0.406
E1	6.500	-	0.256	-
e	2.540		0.100	
e1	5.080		0.200	
N	2		2	
H	14.605	15.875	0.575	0.625
L	2.200	3.000	0.087	0.118
L1	-	1.600	-	0.063
L2	1.000	1.778	0.039	0.070
F1	16.050	16.250	0.632	0.640
F2	9.300	9.500	0.366	0.374
F3	4.500	4.700	0.177	0.185
F4	10.700	10.900	0.421	0.429
F5	3.630	3.830	0.143	0.151
F6	1.100	1.300	0.043	0.051

REFERENCE
JEDEC TO263

SCALE

EUROPEAN PROJECTION

ISSUE DATE
12-02-2006

FILE
TO263_2

PG-TO252-3: Outline

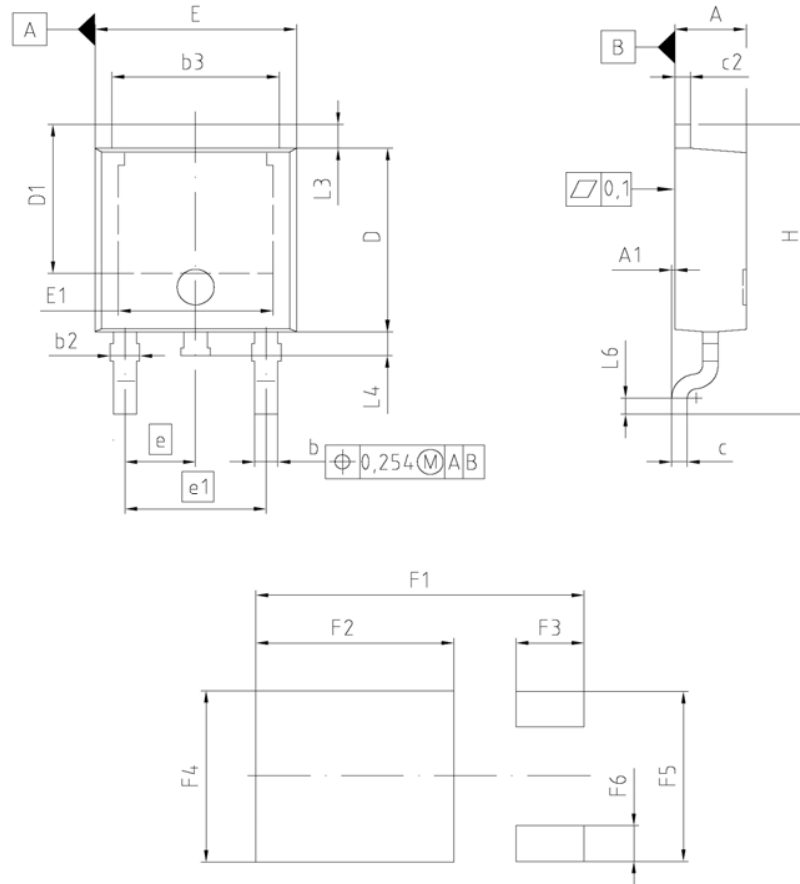

DIM	MILLIMETERS		INCHES	
	MIN	MAX	MIN	MAX
A	2.159	2.413	0.085	0.095
A1	0.000	0.150	0.000	0.006
b	0.635	0.889	0.025	0.035
b2	0.650	1.150	0.026	0.045
b3	5.004	5.500	0.197	0.217
c	0.457	0.580	0.018	0.023
c2	0.460	0.980	0.018	0.039
D	5.969	6.223	0.235	0.245
D1	5.020	5.842	0.198	0.230
E	6.400	6.731	0.252	0.265
E1	4.850	5.207	0.191	0.205
e	2.286		0.090	
e1	4.572		0.180	
N	3		3	
H	9.400	10.480	0.370	0.413
L3	0.900	1.143	0.035	0.045
L4	0.584	0.950	0.023	0.037
L6	0.510	0.686	0.020	0.027
F1	10.500	10.700	0.413	0.421
F2	6.300	6.500	0.248	0.256
F3	2.100	2.300	0.083	0.091
F4	5.700	5.900	0.224	0.232
F5	5.660	5.860	0.222	0.231
F6	1.100	1.300	0.043	0.051

REFERENCE
JEDEC TO252

SCALE

EUROPEAN PROJECTION

ISSUE DATE
21-09-2005

FILE
TO252_1

Published by
Infineon Technologies AG
81726 Munich, Germany
© 2008 Infineon Technologies AG
All Rights Reserved.

Legal Disclaimer

The information given in this document shall in no event be regarded as a guarantee of conditions or characteristics. With respect to any examples or hints given herein, any typical values stated herein and/or any information regarding the application of the device, Infineon Technologies hereby disclaims any and all warranties and liabilities of any kind, including without limitation, warranties of non-infringement of intellectual property rights of any third party.

Information

For further information on technology, delivery terms and conditions and prices, please contact the nearest Infineon Technologies Office (www.infineon.com).

Warnings

Due to technical requirements, components may contain dangerous substances. For information on the types in question, please contact the nearest Infineon Technologies Office. The Infineon Technologies component described in this Data Sheet may be used in life-support devices or systems and/or automotive, aviation and aerospace applications or systems only with the express written approval of Infineon Technologies, if a failure of such components can reasonably be expected to cause the failure of that life-support, automotive, aviation and aerospace device or system or to affect the safety or effectiveness of that device or system. Life support devices or systems are intended to be implanted in the human body or to support and/or maintain and sustain and/or protect human life. If they fail, it is reasonable to assume that the health of the user or other persons may be endangered.

单击下面可查看定价，库存，交付和生命周期等信息

[>>Infineon Technologies\(英飞凌\)](#)

[>>点击查看相关商品](#)