



Never stop thinking

TLV4906K

Value Optimized Hall Effect Switch for Industrial and Consumer Applications

Datasheet

Rev. 1.1, 2010-08-02

Sense and Control

Edition 2010-08-02

**Published by
Infineon Technologies AG
81726 Munich, Germany**

**© 2010 Infineon Technologies AG
All Rights Reserved.**

Legal Disclaimer

The information given in this document shall in no event be regarded as a guarantee of conditions or characteristics. With respect to any examples or hints given herein, any typical values stated herein and/or any information regarding the application of the device, Infineon Technologies hereby disclaims any and all warranties and liabilities of any kind, including without limitation, warranties of non-infringement of intellectual property rights of any third party.

Information

For further information on technology, delivery terms and conditions and prices, please contact the nearest Infineon Technologies Office (www.infineon.com).

Warnings

Due to technical requirements, components may contain dangerous substances. For information on the types in question, please contact the nearest Infineon Technologies Office.

Infineon Technologies components may be used in life-support devices or systems only with the express written approval of Infineon Technologies, if a failure of such components can reasonably be expected to cause the failure of that life-support device or system or to affect the safety or effectiveness of that device or system. Life support devices or systems are intended to be implanted in the human body or to support and/or maintain and sustain and/or protect human life. If they fail, it is reasonable to assume that the health of the user or other persons may be endangered.

Value Optimized Hall Effect Switch for Industrial and Consumer Applications**Revision History: 2010-08-02, Rev. 1.1****Previous Revisions: none**

Page	Subjects (major changes since last revision)
all	package changed to halogen free

We Listen to Your Comments

Any information within this document that you feel is wrong, unclear or missing at all?
Your feedback will help us to continuously improve the quality of this document.
Please send your proposal (including a reference to this document) to:

sensors@infineon.com



Table of Contents

	Table of Contents	4
	List of Figures	5
	List of Tables	6
1	Product Description	7
1.1	Overview	7
1.2	Features	7
1.3	Target Applications	7
2	Functional Description	8
2.1	General	8
2.2	Pin Configuration	8
2.3	Pin Description	9
2.4	Block Diagram	9
2.5	Operating Modes and States	10
2.6	Functional Block Description	10
3	Specification	11
3.1	Application circuit	11
3.2	Absolute Maximum Ratings	11
3.3	Operating Range	12
3.4	Electrical Characteristics	12
4	Package Information	14
4.1	TLV4906K Package Outline	14

List of Figures

Figure 1	Pin Configuration and sensitive area (Top view, figure not to scale)	8
Figure 2	TLV4906K Block Diagram	9
Figure 3	Definition of the Magnetic Field direction	10
Figure 4	Output Signal	10
Figure 5	Application circuit	11
Figure 6	Timing Diagram	13
Figure 7	Marking of the TLV4906K and distance of the chip to the upper side	14
Figure 8	PG-SC59-3-5 Package Outline.	14
Figure 9	Footprint PG-SC59-3-5 (SOT23 compatible)	15

List of Tables

Table 1	PIN Definitions for the PG-SC59-3-5 package	9
Table 2	Absolute Maximum Ratings	11
Table 3	Operating Range	12
Table 4	Electrical Characteristics	12
Table 5	Magnetic Characteristics	13



1 Product Description

1.1 Overview

The TLV4906K is a high precision Hall Effect Switch with highly accurate switching thresholds for ambient operating temperatures up to 85°C.

The TLV4906K is available in a SMD package PG-SC59-3-5 which is lead-free and halogen-free to meet current and future requirements.



1.2 Features

- 2.7 V to 18 V supply voltage operation.
- Operation from unregulated power supply.
- High sensitivity and high stability of the magnetic switching points.
- High resistance to mechanical stress by active error compensation.
- Reverse battery protection (-18 V).
- Superior temperature stability.
- Low jitter (typically 1 μs).
- High ESD performance (± 4 kV HBM).
- Digital output signal (open-drain).
- Lead-free and halogen-free green SMD package
- Not suitable for automotive applications

1.3 Target Applications

The TLV4906K is ideally suited for all industrial and consumer applications that require a high precision switching thresholds for position sensing. It can be used for example for: security systems, alignment control, push buttons, keyboards, key switches, machine tools, etc.

Product Name	Product Type	Ordering Code	Package
TLV4906K	Hall Effect Switch	SP000604310	PG-SC59-3-5

2 Functional Description

2.1 General

Precise magnetic switching thresholds and high temperature stability are achieved by active compensation circuits and chopper techniques on chip. Offset voltages generated by temperature-induced stress or overmolding are canceled so that high accuracy is achieved. The IC has an open collector output stage with 20 mA current sink capability. A wide operating voltage range from 2.7 V to 18 V with reverse polarity protection down to -18 V makes the TLV4906K suitable for a wide range of applications. A magnetic south pole with a field strength above B_{op} turns the output transistor on (output voltage low) and for a magnetic field below B_{rp} the output transistor is switched off (output voltage high).

2.2 Pin Configuration

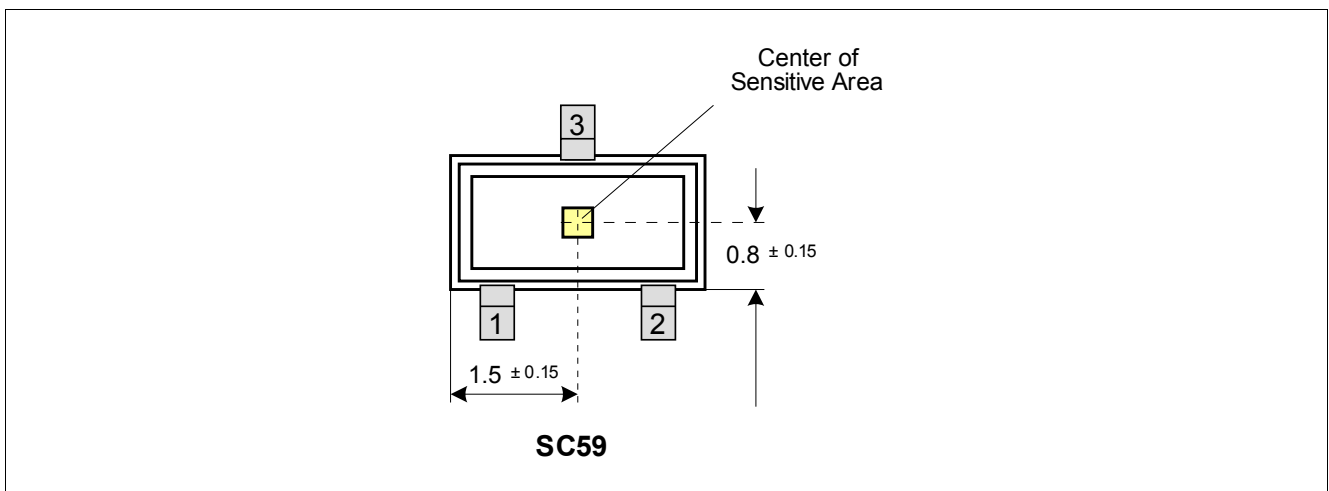

Figure 1 Pin Configuration and sensitive area (Top view, figure not to scale)

2.3 Pin Description

Table 1 PIN Definitions for the PG-SC59-3-5 package

PIN No.	Name	Function
1	V_s	Supply Voltage
2	Q	Output
3	GND	Ground

2.4 Block Diagram



Figure 2 TLV4906K Block Diagram

2.5 Operating Modes and States

Field Direction and Definition

Positive magnetic fields correspond to the south pole of the magnet targeting the branded side of the package.

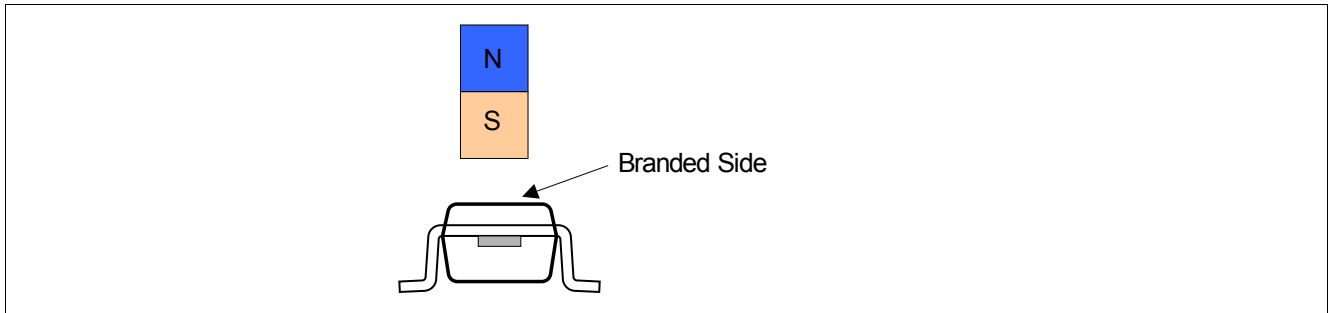

Figure 3 Definition of the Magnetic Field direction

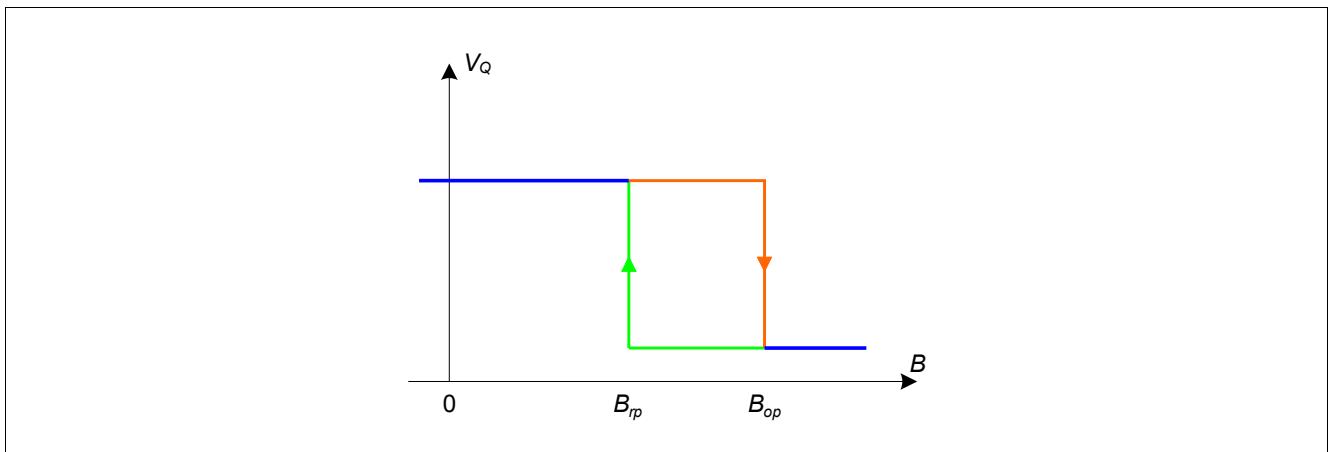

Figure 4 Output Signal

2.6 Functional Block Description

The chopped Hall Effect Switch comprises a Hall probe, a bias generator, compensation circuits, an oscillator and an output transistor. The bias generator provides currents to the Hall probe and the active circuits. Compensation circuits stabilize response of the IC over temperature and reduce the impact of process variations.

The Active Error Compensation rejects offsets in the signal path and reduces the impact of mechanical stress in the package caused by molding, soldering and thermal effects.

The chopper technique together with the threshold generator and the comparator ensure high accurate magnetic switching points.

3 Specification

3.1 Application circuit

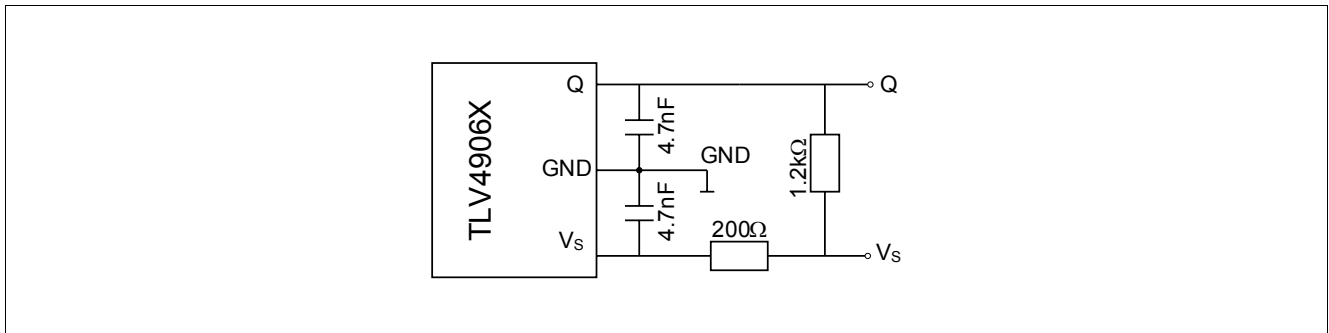

Figure 5 Application circuit

It is recommended to use a resistor of 200 Ω in the supply line for current limitation in the case of an overvoltage pulse. Two capacitors of 4.7 nF enhance the EMC performance. The pull-up of 1.2 k Ω limits the current through the output transistor.

3.2 Absolute Maximum Ratings

Stress above the maximum values listed in this section may cause permanent damage to the device. Exposure to absolute maximum rating conditions for extended periods may affect the reliability of the device. Exceeding only one of these values may cause irreversible damage to the device.

Table 2 Absolute Maximum Ratings

Parameter	Symbol	Values			Unit	Note / Test Condition
		Min.	Typ.	Max.		
Maximum Ambient Temperature	T_A	- 40	–	125	$^{\circ}\text{C}$	
Maximum Junction Temperature	T_J	- 40	–	150	$^{\circ}\text{C}$	
Supply Voltage	V_S	- 18	–	18	V	
Supply current through protection device	I_S	-50	–	50	mA	
Output Voltage	V_{OUT}	- 0.7	–	18	V	
Storage Temperature	T_S	- 40	–	150	$^{\circ}\text{C}$	
Magnetic flux density	B	–	–	unlimited	mT	
ESD Robustness HBM: 1.5 k Ω , 100 pF	$V_{\text{ESD,HBM}}^{1)}$	–	–	4	kV	

1) According to EIA/JESD22-A114-E

3.3 Operating Range

The following operating conditions must not be exceeded in order to ensure correct operation of the TLV4906K. All parameters specified in the following sections refer to these operating conditions unless otherwise mentioned.

Table 3 Operating Range

Parameter	Symbol	Values			Unit	Note / Test Condition
		Min.	Typ.	Max.		
Supply Voltage	V_S	2.7	–	18	V	
Output Voltage	V_Q	-0.7	–	18	V	
Output Current	I_Q	0	–	20	mA	
Maximum Ambient Temperature	T_A	-40	–	85	°C	

3.4 Electrical Characteristics

Product characteristics include the spread of values guaranteed within the specified voltage and ambient temperature range. typical characteristics are the median of the production (at $V_S=12V$ and $T_A=25^\circ C$).

Table 4 Electrical Characteristics

Parameter	Symbol	Values			Unit	Note / Test Condition
		Min.	Typ.	Max.		
Supply Current	I_S	2	4	6	mA	$V_S=2.7 V \dots 18 V$
Reverse Current	I_{SR}	0	0.2	1	mA	$V_S=-18 V$
Output Saturation Voltage	V_{QSAT}	–	0.3	0.6	V	$I_Q=20 mA$
Output leakage current	I_{QLEAK}	–	0.05	10	μA	$V_Q=18 V$
Output fall time ¹⁾	t_f	–	0.02	1	μs	$R_L=1.2k \Omega, C_L=50 pF$
Output rise time ¹⁾	t_r	–	0.4	1	μs	
Chopper frequency	f_{OSC}	–	320	–	kHz	
Switching frequency	f_{SW}	0	–	15 ²⁾	kHz	
Delay time ³⁾	t_d	–	13	–	μs	
Output jitter ⁴⁾	t_{QJ}	–	1	–	μs_{RMS}	Typical value for a 1 kHz square wave signal
Power-on Time ⁵⁾	t_{PON}	–	13	–	μs	$V_S > 2.7 V$
Thermal Resistance junction to ambient ⁶⁾	R_{thja}	–	100	–	K/W	TLV4906K

1) See [Figure 6](#)

2) To operate the sensor at maximum switching frequency, the value of the magnetic signal amplitude must be 1.4 times higher than the static fields. This is due to the -3 dB corner frequency of the low pass filter in the signal path.

3) Systematic delay between magnetic threshold reached and output.

4) Jitter is the unpredictable deviation of the output switching delay.

5) Time from applying $V_S > 2.7 V$ to the sensor until the output state is valid.

6) Relationship between junction and ambient temperature: $T_J=T_{amb} + R_{thja} \cdot (V_S \cdot I_S + V_{QS} \cdot I_Q)$.



Figure 6 Timing Diagram

Table 5 Magnetic Characteristics ¹⁾

Parameter	Symbol	Values			Unit	Note / Test Condition
		Min.	Typ.	Max.		
Operate point	B_{OP}	6.2	10.0	13.9	mT	
Release point	B_{RP}	4.7	8.5	12.3	mT	
Hysteresis	B_{HYS}	0.7	1.5	3.0	mT	²⁾
Temperature compensation of magnetic thresholds	TC	–	-350	–	ppm/°C	
Repeatability of magnetic thresholds ³⁾	B_{REP}	–	20	–	μT_{RMS}	typical value for $\Delta B/\Delta t > 12\text{mT/ms}$

1) Over all operating conditions.

2) At 25°C.

3) B_{REP} is equivalent to the noise constant.

4 Package Information

4.1 TLV4906K Package Outline

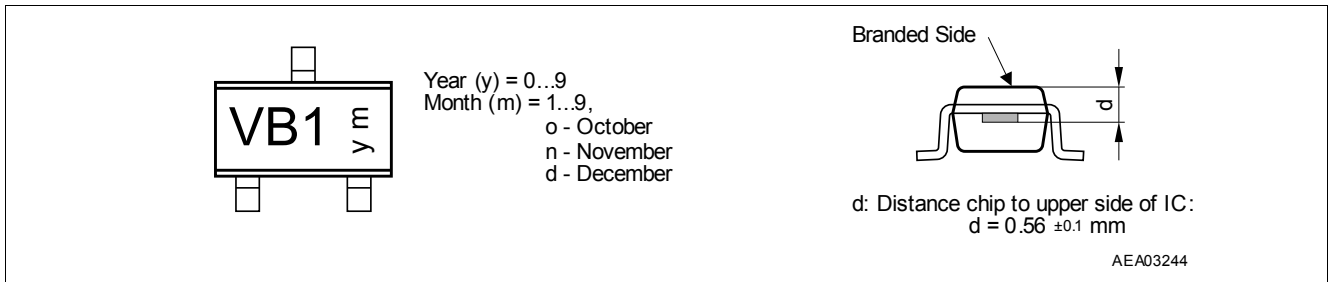

Figure 7 Marking of the TLV4906K and distance of the chip to the upper side

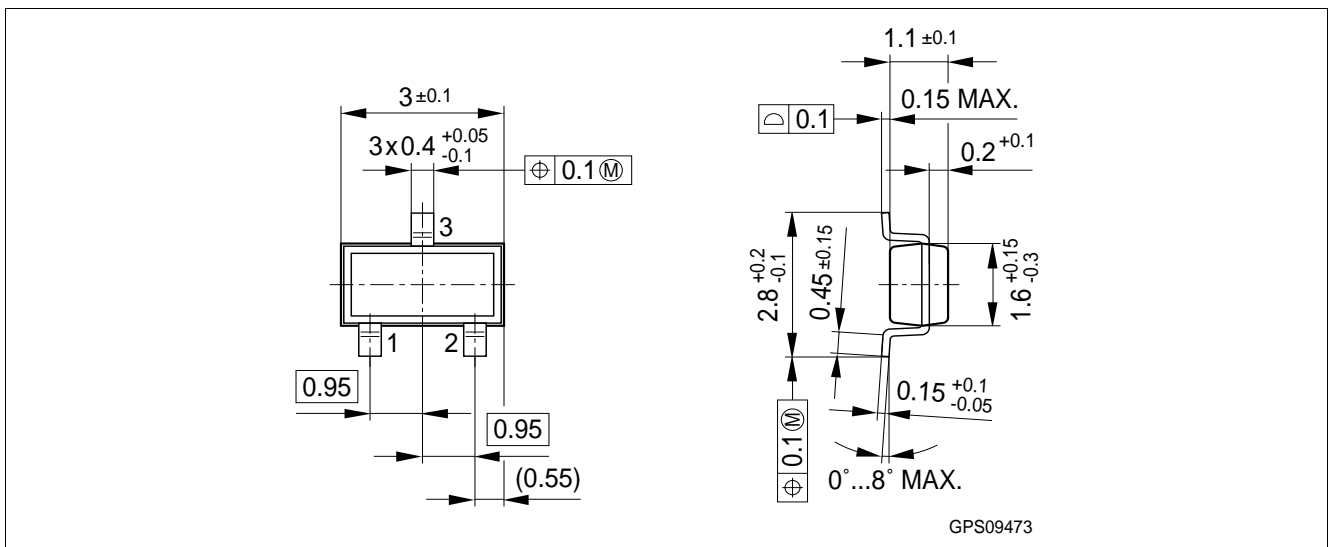

Figure 8 PG-SC59-3-5 Package Outline

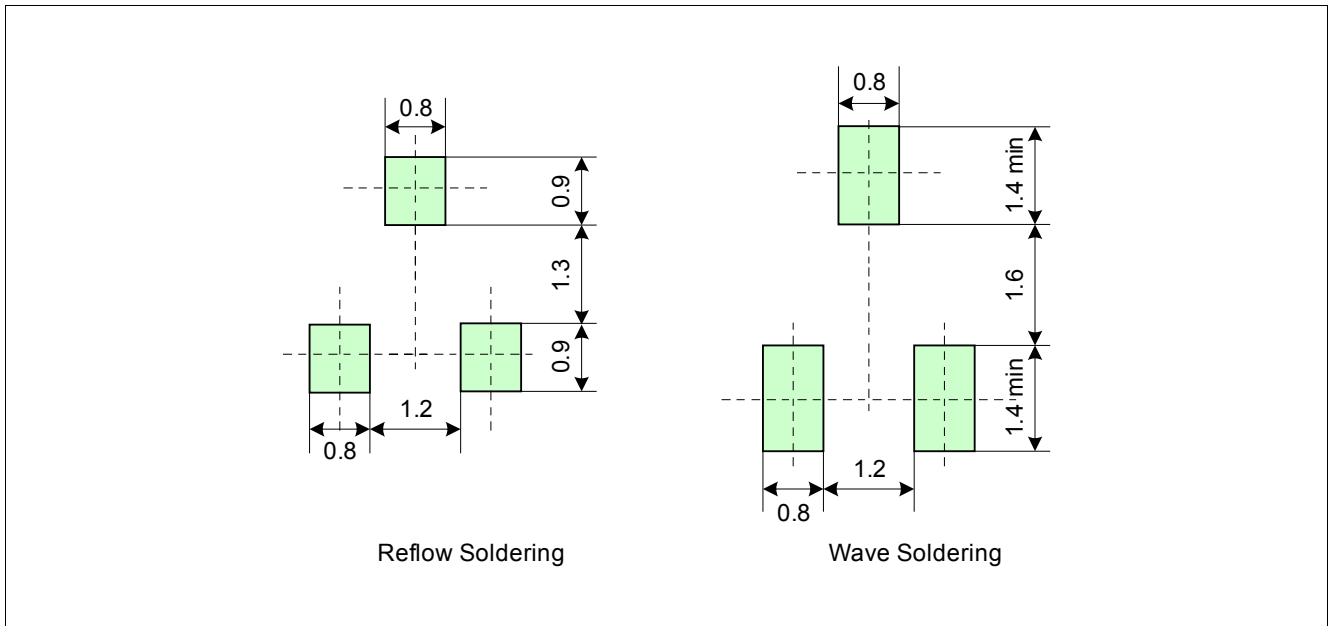

Figure 9 Footprint PG-SC59-3-5 (SOT23 compatible)

www.infineon.com

Published by Infineon Technologies AG

Downloaded From Oneyac.com

单击下面可查看定价，库存，交付和生命周期等信息

[>>Infineon Technologies\(英飞凌\)](#)

[>>点击查看相关商品](#)