

# HybridPACK™ 2 Module

FS900R08A2P2\_B31

## Final Data Sheet

V3.2, 2017-08-30

Automotive High Power

## 1 Features / Description

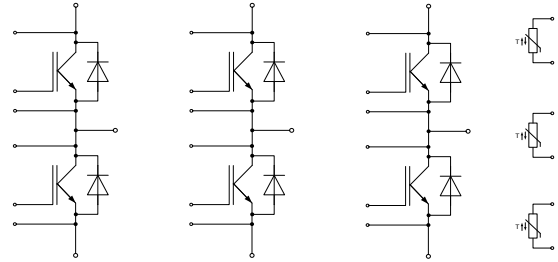
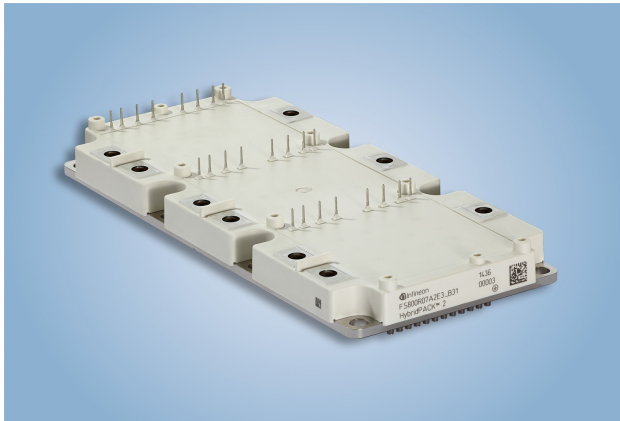

$V_{CES} = 750V$   
 $I_{C\ nom} = 900A$

### Typical Applications

- Automotive Applications
- Hybrid Electrical Vehicles (H)EV
- Commercial Agriculture Vehicles
- Motor Drives
- Optimized for automotive applications with DC link voltages up to 450 V

### Electrical Features

- $V_{CESat}$  with positive Temperature Coefficient
- Low  $V_{CESat}$
- Low Switching Losses
- Low  $Q_g$  and  $C_{res}$
- Low Inductive Design
- $T_{vj\ op} = 150^\circ C$
- Short-time extended Operation Temperature  
 $T_{vj\ op} = 175^\circ C$

### Mechanical Features

- 2.5kV AC 1min Insulation
- Direct Cooled PinFin Base Plate
- High Power Density
- Integrated NTC temperature sensor
- Copper Base Plate
- Isolated Base Plate
- RoHS compliant

Product Name	Ordering Code
FS900R08A2P2_B31	-

## 2 IGBT, Inverter

### 2.1 Maximum Rated Values

Parameter	Conditions	Symbol	Value	Unit
Collector-emitter voltage	$T_{vj} = 25^{\circ}\text{C}$	$V_{CES}$	750	V
Implemented collector current		$I_{CN}$	900	A
Continuous DC collector current	$T_F = 105^{\circ}\text{C}$ , $T_{vj\max} = 175^{\circ}\text{C}$	$I_{C\text{nom}}$	550	A
Repetitive peak collector current	$t_p = 1\text{ ms}$	$I_{CRM}$	1800	A
Total power dissipation	$T_F = 25^{\circ}\text{C}$ , $T_{vj\max} = 175^{\circ}\text{C}$	$P_{\text{tot}}$	1546	W
Gate-emitter peak voltage		$V_{GES}$	+/-20	V

### 2.2 Characteristic Values

Parameter	Conditions	Symbol	min. typ. max.			Unit	
Collector-emitter saturation voltage	$I_C = 550\text{ A}$ , $V_{GE} = 15\text{ V}$ $I_C = 550\text{ A}$ , $V_{GE} = 15\text{ V}$ $I_C = 550\text{ A}$ , $V_{GE} = 15\text{ V}$	$T_{vj} = 25^{\circ}\text{C}$ $T_{vj} = 125^{\circ}\text{C}$ $T_{vj} = 150^{\circ}\text{C}$	$V_{CE\text{sat}}$	1.10 1.10 1.10	1.25	V	
Gate threshold voltage	$I_C = 13.0\text{ mA}$ , $V_{CE} = V_{GE}$	$T_{vj} = 25^{\circ}\text{C}$	$V_{GE\text{th}}$	4.90	5.80	6.50	V
Gate charge	$V_{GE} = -8\text{ V} \dots 15\text{ V}$ , $V_{CE} = 400\text{ V}$		$Q_G$	5.80		$\mu\text{C}$	
Internal gate resistor		$T_{vj} = 25^{\circ}\text{C}$	$R_{G\text{int}}$	0.5		$\Omega$	
Input capacitance	$f = 1\text{ MHz}$ , $V_{CE} = 25\text{ V}$ , $V_{GE} = 0\text{ V}$	$T_{vj} = 25^{\circ}\text{C}$	$C_{\text{ies}}$	105		nF	
Reverse transfer capacitance	$f = 1\text{ MHz}$ , $V_{CE} = 25\text{ V}$ , $V_{GE} = 0\text{ V}$	$T_{vj} = 25^{\circ}\text{C}$	$C_{\text{res}}$	0.50		nF	
Collector-emitter cut-off current	$V_{CE} = 450\text{ V}$ , $V_{GE} = 0\text{ V}$	$T_{vj} = 25^{\circ}\text{C}$	$I_{CES}$		0.5	mA	
Gate-emitter leakage current	$V_{CE} = 0\text{ V}$ , $V_{GE} = 20\text{ V}$	$T_{vj} = 25^{\circ}\text{C}$	$I_{GES}$		400	nA	
Turn-on delay time, inductive load	$I_C = 550\text{ A}$ , $V_{CE} = 400\text{ V}$ $V_{GE} = -8\text{ V} / +15\text{ V}$ $R_{G\text{on}} = 3.3\ \Omega$	$T_{vj} = 25^{\circ}\text{C}$ $T_{vj} = 125^{\circ}\text{C}$ $T_{vj} = 150^{\circ}\text{C}$	$t_{d\text{on}}$	0.39 0.39 0.39		$\mu\text{s}$	
Rise time, inductive load	$I_C = 550\text{ A}$ , $V_{CE} = 400\text{ V}$ $V_{GE} = -8\text{ V} / +15\text{ V}$ $R_{G\text{on}} = 3.3\ \Omega$	$T_{vj} = 25^{\circ}\text{C}$ $T_{vj} = 125^{\circ}\text{C}$ $T_{vj} = 150^{\circ}\text{C}$	$t_r$	0.09 0.11 0.11		$\mu\text{s}$	
Turn-off delay time, inductive load	$I_C = 550\text{ A}$ , $V_{CE} = 400\text{ V}$ $V_{GE} = -8\text{ V} / +15\text{ V}$ $R_{G\text{off}} = 2.0\ \Omega$	$T_{vj} = 25^{\circ}\text{C}$ $T_{vj} = 125^{\circ}\text{C}$ $T_{vj} = 150^{\circ}\text{C}$	$t_{d\text{off}}$	0.63 0.71 0.74		$\mu\text{s}$	
Fall time, inductive load	$I_C = 550\text{ A}$ , $V_{CE} = 400\text{ V}$ $V_{GE} = -8\text{ V} / +15\text{ V}$ $R_{G\text{off}} = 2.0\ \Omega$	$T_{vj} = 25^{\circ}\text{C}$ $T_{vj} = 125^{\circ}\text{C}$ $T_{vj} = 150^{\circ}\text{C}$	$t_f$	0.06 0.08 0.08		$\mu\text{s}$	
Turn-on energy loss per pulse	$I_C = 550\text{ A}$ , $V_{CE} = 400\text{ V}$ , $L_S = 20\text{ nH}$ $V_{GE} = -8\text{ V} / +15\text{ V}$ $R_{G\text{on}} = 3.3\ \Omega$ $di/dt (T_{vj} = 150^{\circ}\text{C}) = 4100\text{ A}/\mu\text{s}$	$T_{vj} = 25^{\circ}\text{C}$ $T_{vj} = 125^{\circ}\text{C}$ $T_{vj} = 150^{\circ}\text{C}$	$E_{\text{on}}$	21.0 29.0 30.5		mJ	
Turn-off energy loss per pulse	$I_C = 550\text{ A}$ , $V_{CE} = 400\text{ V}$ , $L_S = 20\text{ nH}$ $V_{GE} = -8\text{ V} / +15\text{ V}$ $R_{G\text{off}} = 2.0\ \Omega$ $dv/dt (T_{vj} = 150^{\circ}\text{C}) = 2600\text{ V}/\mu\text{s}$	$T_{vj} = 25^{\circ}\text{C}$ $T_{vj} = 125^{\circ}\text{C}$ $T_{vj} = 150^{\circ}\text{C}$	$E_{\text{off}}$	27.5 36.0 38.5		mJ	
SC data	$V_{GE} \leq 15\text{ V}$ , $V_{CC} = 400\text{ V}$ $V_{CE\text{max}} = V_{CES} - L_{S\text{CE}} \cdot di/dt$ $t_p \leq 4\ \mu\text{s}$ , $T_{vj} = 150^{\circ}\text{C}$		$I_{SC}$	4500		A	
Thermal resistance, junction to cooling fluid	per IGBT; $\Delta V/\Delta t = 10\text{ dm}^3/\text{min}$		$R_{\text{thJF}}$		0.097	K/W	
Temperature under switching conditions	$t_{op}$ continuous $t_{op\max}$ 30h over life time, for 10s within period of 10min		$T_{vj\text{op}}$	-40 150	150 175	$^{\circ}\text{C}$	

### 3 Diode, Inverter

#### 3.1 Maximum Rated Values

Parameter	Conditions	Symbol	Value	Unit
Repetitive peak reverse voltage	$T_{vj} = 25^{\circ}\text{C}$	$V_{RRM}$	750	V
Implemented forward current		$I_{FN}$	860	A
Continuous DC forward current		$I_F$	550	A
Repetitive peak forward current	$t_p = 1 \text{ ms}$	$I_{FRM}$	1720	A
$I^2t$ - value	$V_R = 0 \text{ V}, t_p = 10 \text{ ms}, T_{vj} = 125^{\circ}\text{C}$ $V_R = 0 \text{ V}, t_p = 10 \text{ ms}, T_{vj} = 150^{\circ}\text{C}$	$I^2t$	19500 19000	$\text{A}^2\text{s}$ $\text{A}^2\text{s}$

#### 3.2 Characteristic Values

Parameter	Conditions	Symbol	min. typ. max.			Unit	
Forward voltage	$I_F = 550 \text{ A}, V_{GE} = 0 \text{ V}$ $I_F = 550 \text{ A}, V_{GE} = 0 \text{ V}$ $I_F = 550 \text{ A}, V_{GE} = 0 \text{ V}$	$T_{vj} = 25^{\circ}\text{C}$ $T_{vj} = 125^{\circ}\text{C}$ $T_{vj} = 150^{\circ}\text{C}$	$V_F$		1.40 1.30 1.25	1.65	V
Peak reverse recovery current	$I_F = 550 \text{ A}, -di_F/dt = 4100 \text{ A}/\mu\text{s} (T_{vj} = 150^{\circ}\text{C})$ $V_R = 400 \text{ V}$ $V_{GE} = -8 \text{ V}$	$T_{vj} = 25^{\circ}\text{C}$ $T_{vj} = 125^{\circ}\text{C}$ $T_{vj} = 150^{\circ}\text{C}$	$I_{RM}$		265 385 420		A
Recovered charge	$I_F = 550 \text{ A}, -di_F/dt = 4100 \text{ A}/\mu\text{s} (T_{vj} = 150^{\circ}\text{C})$ $V_R = 400 \text{ V}$ $V_{GE} = -8 \text{ V}$	$T_{vj} = 25^{\circ}\text{C}$ $T_{vj} = 125^{\circ}\text{C}$ $T_{vj} = 150^{\circ}\text{C}$	$Q_r$		23.0 49.5 58.5		$\mu\text{C}$
Reverse recovery energy	$I_F = 550 \text{ A}, -di_F/dt = 4100 \text{ A}/\mu\text{s} (T_{vj} = 150^{\circ}\text{C})$ $V_R = 400 \text{ V}$ $V_{GE} = -8 \text{ V}$	$T_{vj} = 25^{\circ}\text{C}$ $T_{vj} = 125^{\circ}\text{C}$ $T_{vj} = 150^{\circ}\text{C}$	$E_{rec}$		7.20 15.0 17.5		mJ
Thermal resistance, junction to cooling fluid	per diode; $\Delta V/\Delta t = 10 \text{ dm}^3/\text{min}$		$R_{thJF}$			0.125	K/W
Temperature under switching conditions	$t_{op}$ continuous $t_{op \text{ max}}$ 30h over life time, for 10s within period of 10min		$T_{vj \text{ op}}$	-40 150		150 175	$^{\circ}\text{C}$

### 4 NTC-Thermistor

Parameter	Conditions	Symbol	min. typ. max.			Unit
Rated resistance	$T_C = 25^{\circ}\text{C}$	$R_{25}$		5.00		$\text{k}\Omega$
Deviation of $R_{100}$	$T_C = 100^{\circ}\text{C}, R_{100} = 493 \Omega$	$\Delta R/R$	5		5	%
Power dissipation	$T_C = 25^{\circ}\text{C}$	$P_{25}$			20.0	mW
B-value	$R_2 = R_{25} \exp [B_{25/50}(1/T_2 - 1/(298,15 \text{ K}))]$	$B_{25/50}$		3375		K
B-value	$R_2 = R_{25} \exp [B_{25/80}(1/T_2 - 1/(298,15 \text{ K}))]$	$B_{25/80}$		3411		K
B-value	$R_2 = R_{25} \exp [B_{25/100}(1/T_2 - 1/(298,15 \text{ K}))]$	$B_{25/100}$		3433		K

Specification according to the valid application note.

## 5 Module

Parameter	Conditions	Symbol	Value			Unit
			min.	typ.	max.	
Isolation test voltage	RMS, f = 50 Hz, t = 1 min.	V <sub>ISOL</sub>	2.5			kV
Material of module baseplate			Cu			
Internal isolation	basic insulation (class 1, IEC 61140)		Al <sub>2</sub> O <sub>3</sub>			
Creepage distance	terminal to heatsink	d <sub>Creep</sub>	7.0			mm
	terminal to terminal		5.5			
Clearance	terminal to heatsink	d <sub>Clear</sub>	7.0			mm
	terminal to terminal		5.0			
Comperative tracking index		CTI	> 200			
Pressure drop in cooling circuit	$\Delta V/\Delta t = 10.0 \text{ dm}^3/\text{min}; T_F = 25^\circ\text{C}$	$\Delta p$		119		mbar
Maximum pressure in cooling circuit		p			2.5	bar
Stray inductance module		L <sub>sCE</sub>		14		nH
Module lead resistance, terminals - chip	T <sub>F</sub> = 25 °C, per switch	R <sub>CC'+EE'</sub>		0.80		mΩ
Storage temperature		T <sub>stg</sub>	-40		125	°C
Mounting torque for modul mounting	Screw M6 baseplate to heatsink	M	3.00		6.00	Nm
Terminal connection torque	Screw M6	M	2.5	-	5.0	Nm
Weight		G		1340		g

\* Kühleraufbau gemäß gültiger Application Note.

\* Cooler setup according to the valid application note.

## 6 Characteristics Diagrams

output characteristic IGBT, Inverter (typical)

$I_C = f(V_{CE})$   
 $V_{GE} = 15\text{ V}$

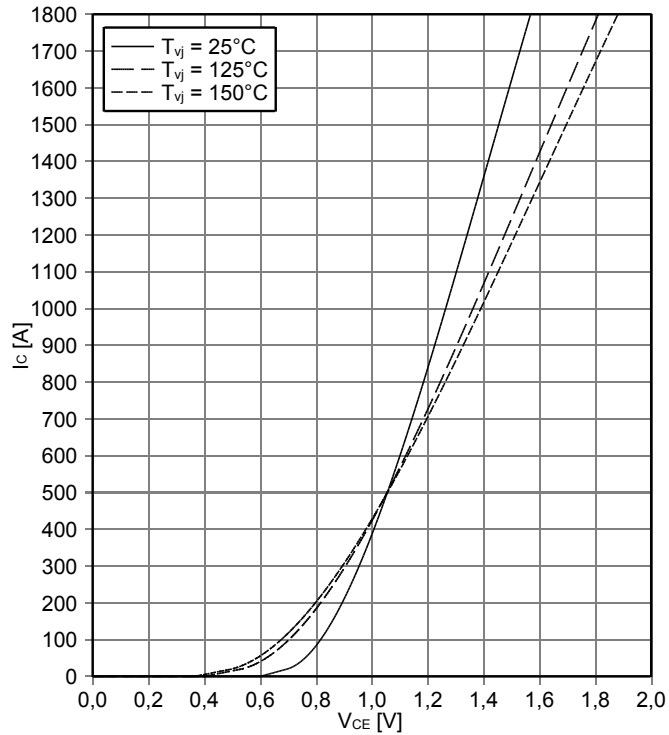

output characteristic IGBT, Inverter (typical)

$I_C = f(V_{CE})$   
 $T_{vj} = 150^\circ\text{C}$

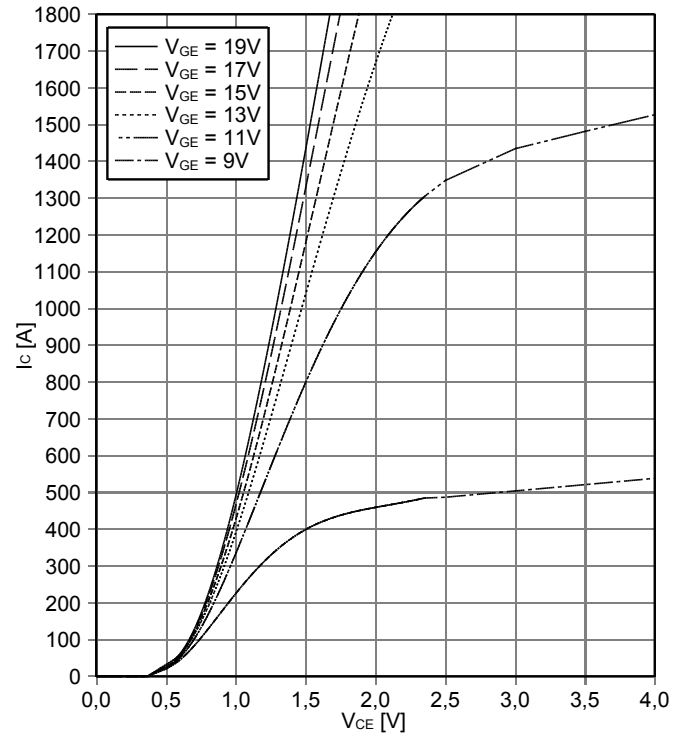

transfer characteristic IGBT, Inverter (typical)

$I_C = f(V_{GE})$   
 $V_{CE} = 20\text{ V}$

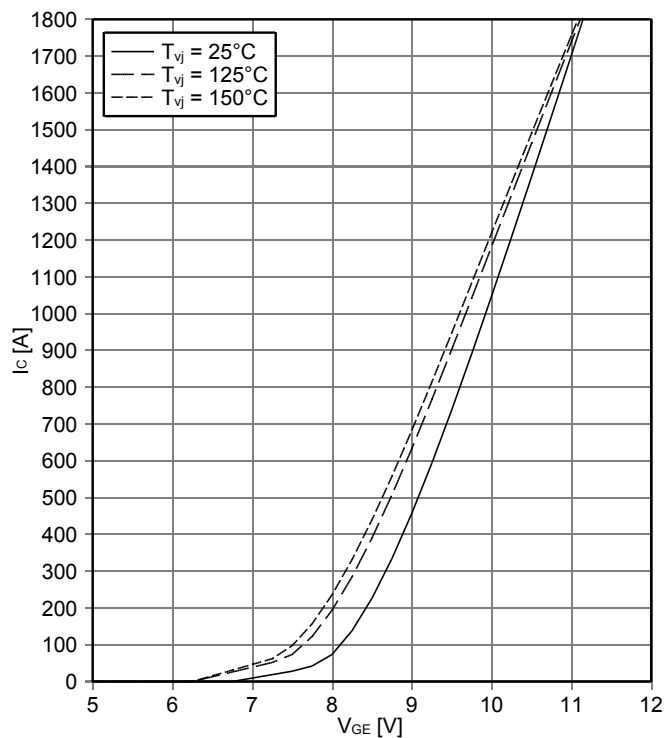

switching losses IGBT, Inverter (typical)

$E_{on} = f(I_C)$ ,  $E_{off} = f(I_C)$   
 $V_{GE} = \pm 15\text{ V}$ ,  $R_{Gon} = 3.3\ \Omega$ ,  $R_{Goff} = 2\ \Omega$ ,  $V_{CE} = 400\text{ V}$

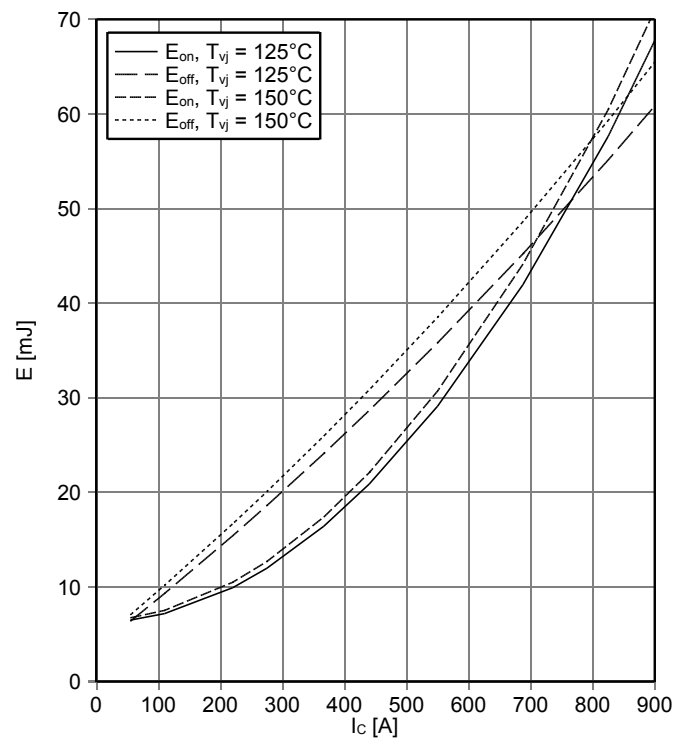

**switching losses IGBT, Inverter (typical)**

$E_{on} = f(R_G)$ ,  $E_{off} = f(R_G)$   
 $V_{GE} = \pm 15\text{ V}$ ,  $I_C = 550\text{ A}$ ,  $V_{CE} = 400\text{ V}$

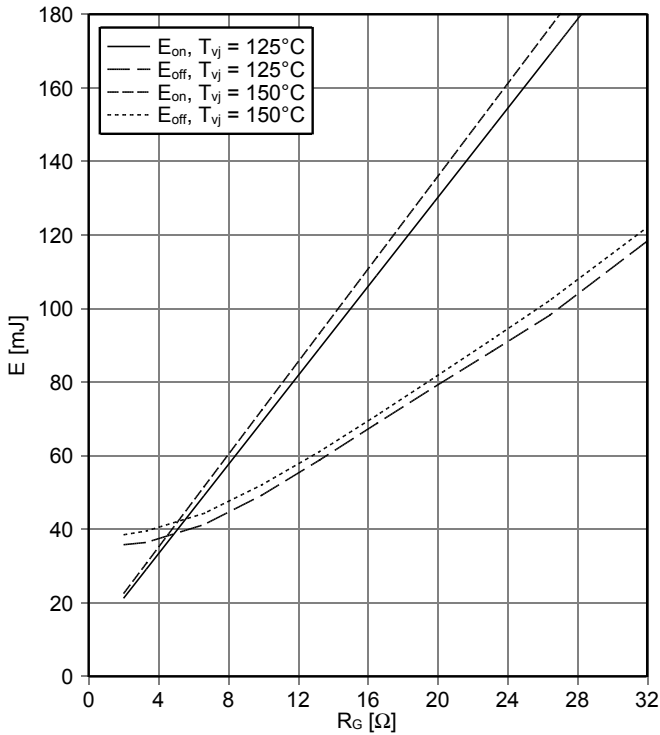

**transient thermal impedance IGBT, Inverter**

$Z_{thJF} = f(t)$  ( $\Delta V/\Delta t = 10\text{ dm}^3/\text{min}$ )

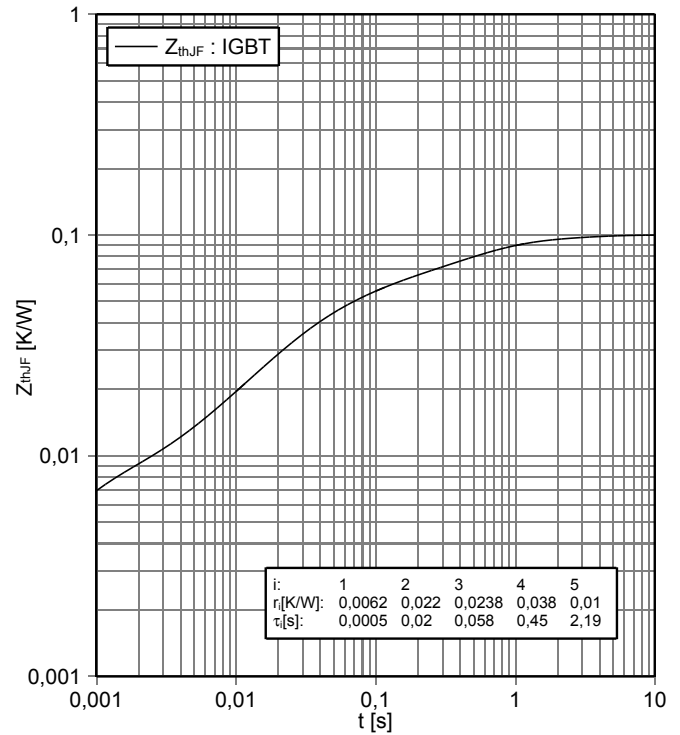

**reverse bias safe operating area IGBT, Inverter (RBSOA)**

$I_C = f(V_{CE})$   
 $V_{GE} = \pm 15\text{ V}$ ,  $R_{Goff} = 2\ \Omega$ ,  $T_{vj} = 150^\circ\text{C}$

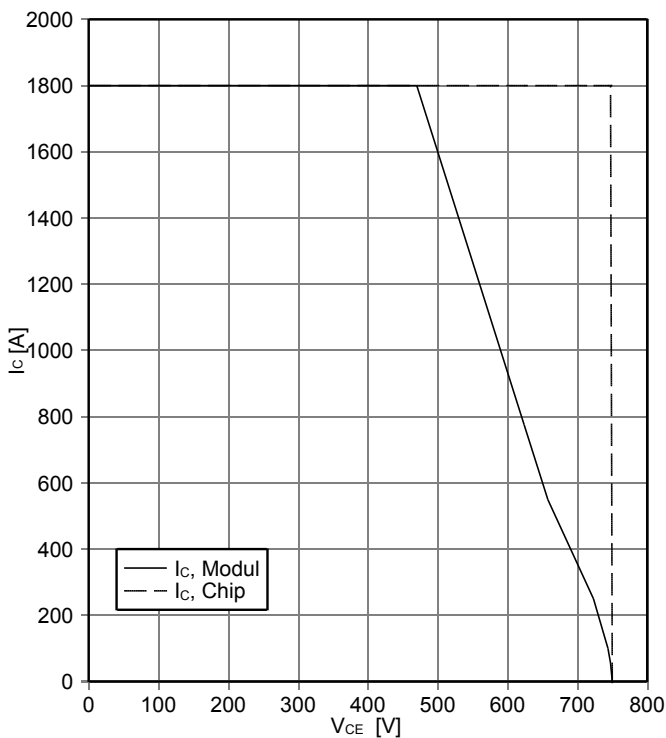

**thermal impedance IGBT, Inverter**

$R_{thJF} = f(\Delta V/\Delta t)$   
 cooling fluid = 50% water/50% ethylenglycol

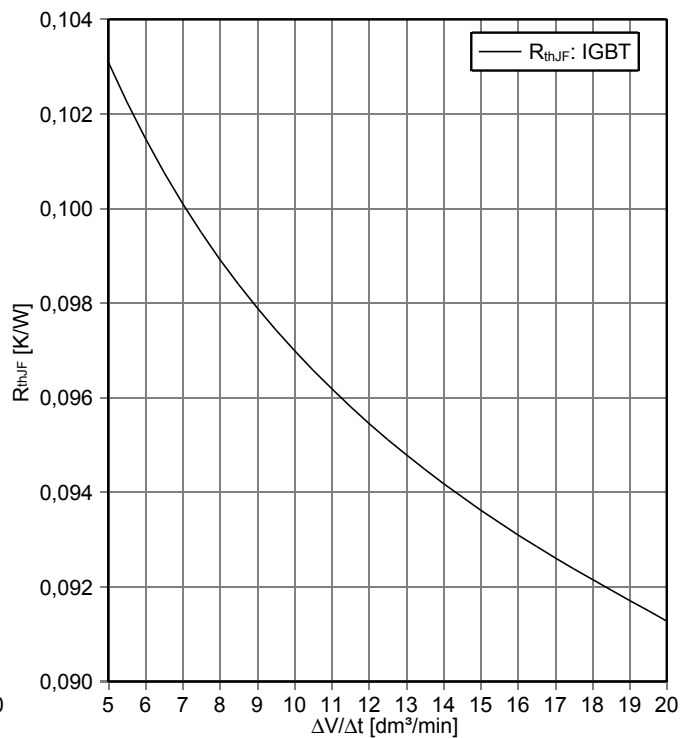

**forward characteristic of Diode, Inverter (typical)**

$I_F = f(V_F)$

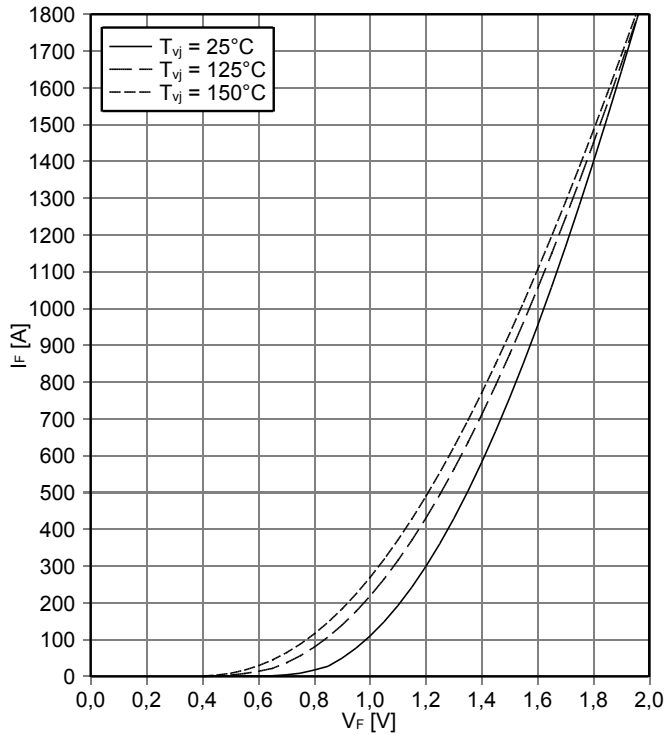

**switching losses Diode, Inverter (typical)**

$E_{rec} = f(I_F)$

$R_{Gon} = 3.3 \Omega$ ,  $V_{CE} = 400 \text{ V}$

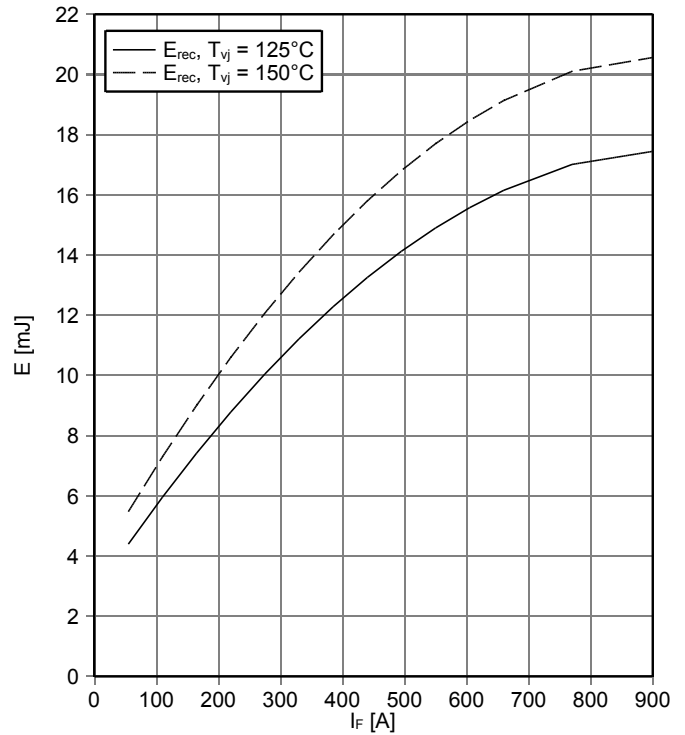

**switching losses Diode, Inverter (typical)**

$E_{rec} = f(R_G)$

$I_F = 550 \text{ A}$ ,  $V_{CE} = 400 \text{ V}$

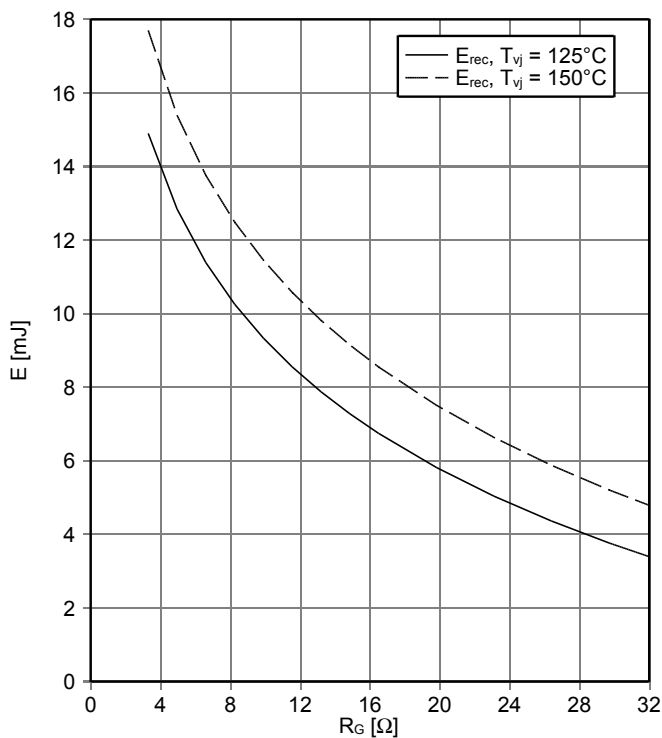

**transient thermal impedance Diode, Inverter**

$Z_{thJF} = f(t)$  ( $\Delta V/\Delta t = 10 \text{ dm}^3/\text{min}$ )

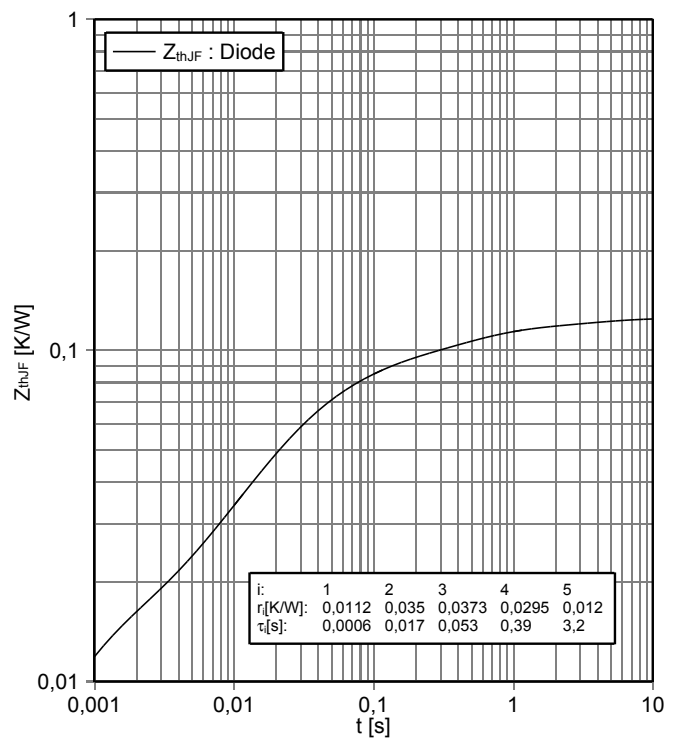



**thermal impedance Diode, Inverter**

$R_{thJF} = f(\Delta V/\Delta t)$

cooling fluid = 50% water/50% ethylenglycol

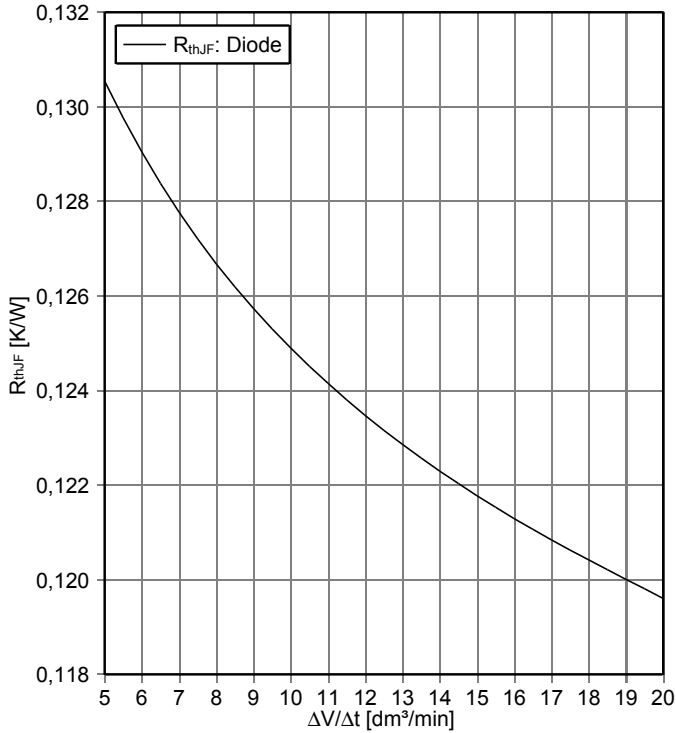

**NTC-Thermistor-temperature characteristic (typical)**

$R = f(T)$

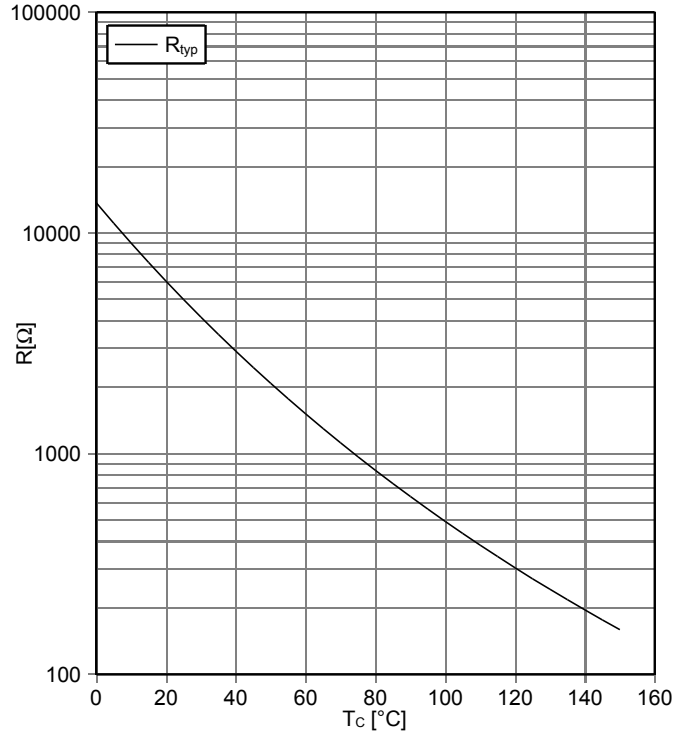

**pressure drop in cooling circuit**

$\Delta p = f(\Delta V/\Delta t)$

cooling fluid = 50% water/50% ethylenglycol, T<sub>F</sub> = 25°C

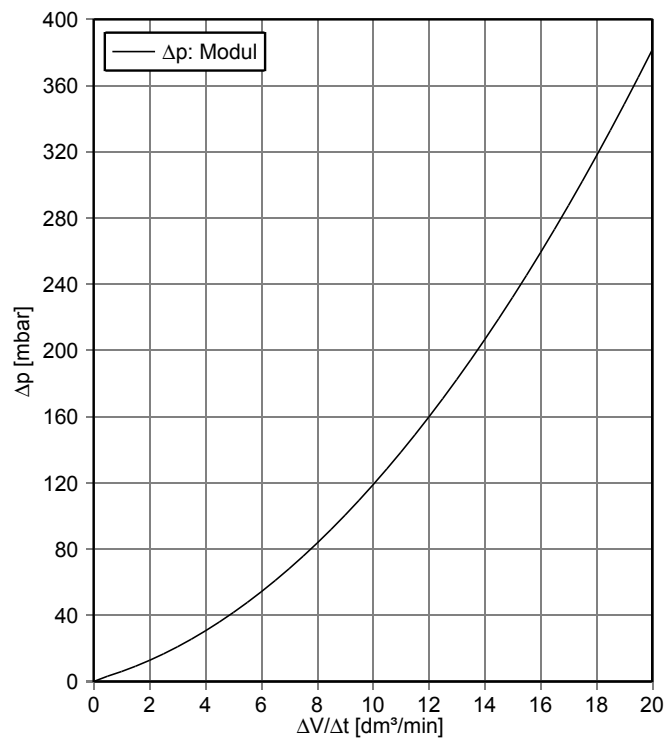

7 Circuit diagram

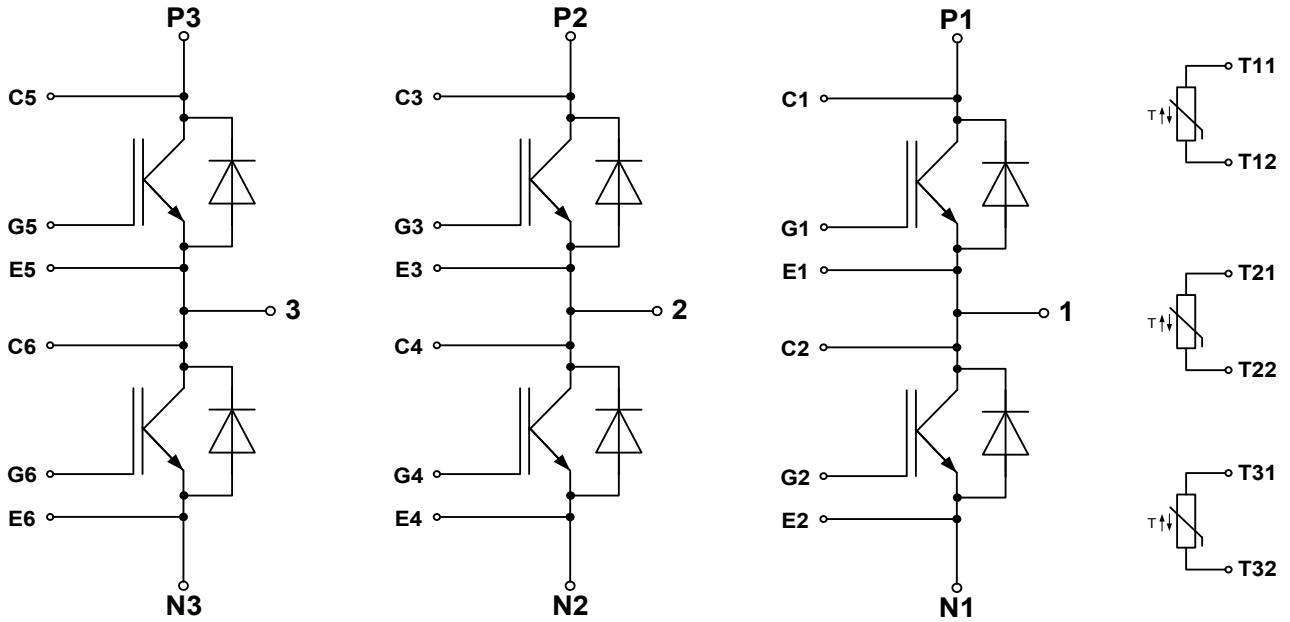

### 8 Package outlines

ISO 8015 principle of independency dimensions ISO 14405 (G) target geometry according CAD file with general tolerances (M) method of least-squares	Drawing: D00018099.00.G
	edges general tolerances surface
	DIN ISO 13715
	1. DIN 16742-TG6 2. DIN ISO 2768-mk DIN EN ISO 1302

All dimensions refer to module in delivery condition

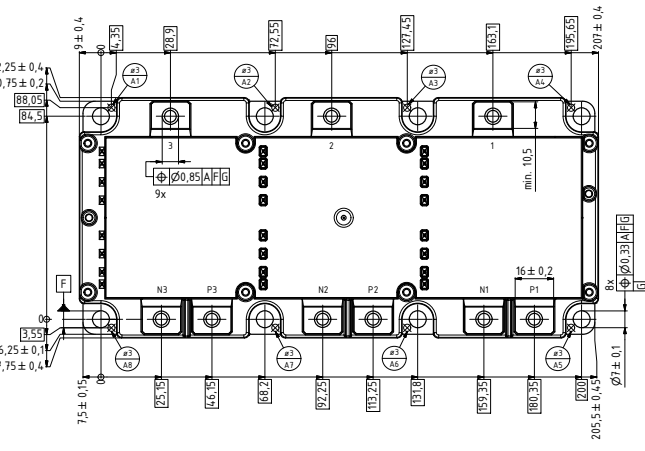
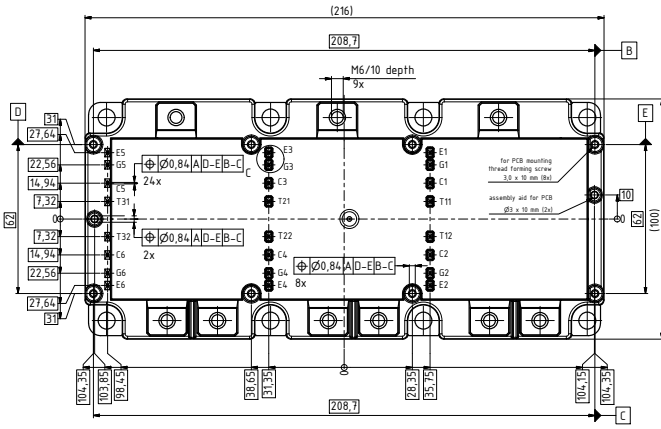
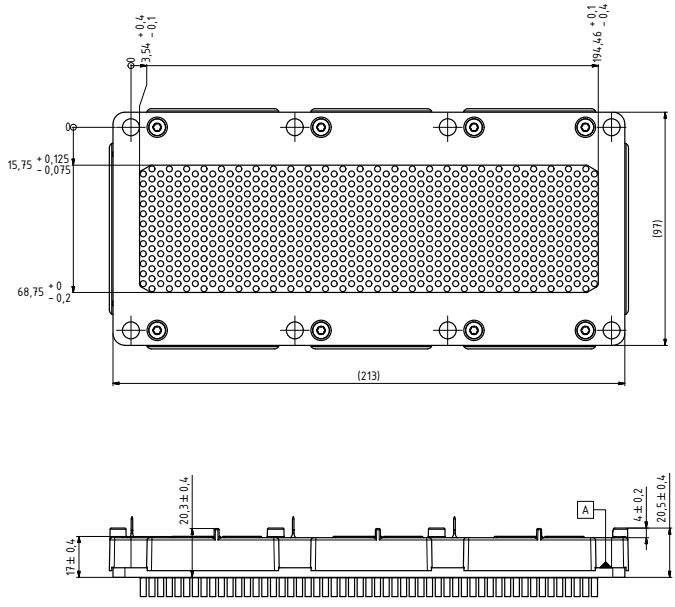
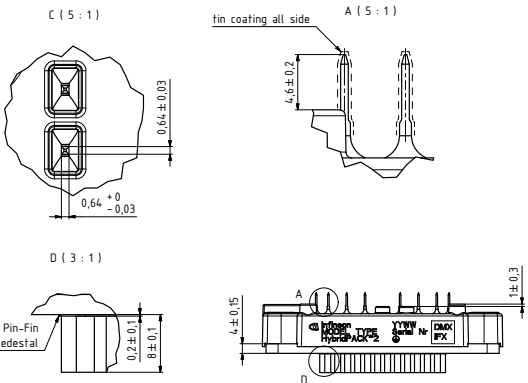

## 9 Label Codes

### 9.1 Module Code

<b>Code Format</b>	Data Matrix		
<b>Encoding</b>	ASCII Text		
<b>Symbol Size</b>	16x16		
<b>Standard</b>	IEC24720 and IEC16022		
<b>Code Content</b>	<b>Content</b> Module Serial Number Module Material Number Production Order Number Datecode (Production Year) Datecode (Production Week)	<b>Digit</b> 1 - 5 6 - 11 12 - 19 20 - 21 22 - 23	<b>Example (below)</b> 71549 142846 55054991 15 30
<b>Example</b>	 71549142846550549911530		

### 9.2 Packing Code

<b>Code Format</b>	Code128			
<b>Encoding</b>	Code Set A			
<b>Symbol Size</b>	34 digits			
<b>Standard</b>	IEC8859-1			
<b>Code Content</b>	<b>Content</b> Backend Construction Number Production Lot Number Serial Number Date Code Box Quantity	<b>Identifier</b> X 1T S 9D Q	<b>Digit</b> 2 - 9 12 - 19 21 - 25 28 - 31 33 - 34	<b>Example (below)</b> 95056609 2X0003E0 754389 1139 15
<b>Example</b>	 X950566091T2X0003E0S754389D1139Q15			

## Revision History

Major changes since previous revision

---

### Revision History

Reference	Date	Description
V1.0	2014-07-11	Initial Version
V2.0	2016-01-13	preliminary data
V2.1	2016-04-11	-
V3.0	2016-11-07	Final datasheet
V3.1	2016-11-14	-
V3.2	2017-08-30	-

## Terms & Conditions of usage

Edition 2014-05-30

Published by  
**Infineon Technologies AG**  
**81726 Munich, Germany**  
 © 2014 Infineon Technologies AG  
 All Rights Reserved.

### Legal Disclaimer

The information given in this document shall in no event be regarded as a guarantee of conditions or characteristics. With respect to any examples or hints given herein, any typical values stated herein and/or any information regarding the application of the device, Infineon Technologies hereby disclaims any and all warranties and liabilities of any kind, including without limitation, warranties of non-infringement of intellectual property rights of any third party.

### Information

For further information on technology, delivery terms and conditions and prices, please contact the nearest Infineon Technologies Office (<http://www.infineon.com>)

### Warnings

Due to technical requirements, components may contain dangerous substances. For information on the types in question, please contact the nearest Infineon Technologies Office.

Infineon Technologies components may be used in life-support devices or systems only with the express written approval of Infineon Technologies, if a failure of such components can reasonably be expected to cause the failure of that life-support device or system or to affect the safety or effectiveness of that device or system. Life support devices or systems are intended to be implanted in the human body or to support and/or maintain and sustain and/or protect human life. If they fail, it is reasonable to assume that the health of the user or other persons may be endangered.

## Trademarks

### Trademarks of Infineon Technologies AG

AURIX™, C166™, CanPAK™, CIPOS™, CIPURSE™, EconoPACK™, CoolMOS™, CoolSET™, CORECONTROL™, CROSSAVE™, DAVE™, DI-POL™, EasyPIM™, EconoBRIDGE™, EconoDUAL™, EconoPIM™, EconoPACK™, EiceDRIVER™, eupec™, FCOS™, HITFET™, HybridPACK™, I<sup>2</sup>RF™, ISOFACE™, IsoPACK™, MIPAK™, ModSTACK™, my-d™, NovalithIC™, OptiMOS™, ORIGA™, POWERCODE™, PRIMARION™, PrimePACK™, PrimeSTACK™, PRO-SIL™, PROFET™, RASIC™, ReverSave™, SatRIC™, SIEGET™, SINDRION™, SIPMOS™, SmartLEWIS™, SOLID FLASH™, TEMPFET™, thinQ!™, TRENCHSTOP™, TriCore™.

### Other Trademarks

Advance Design System™ (ADS) of Agilent Technologies, AMBA™, ARM™, MULTI-ICE™, KEIL™, PRIMECELL™, REALVIEW™, THUMB™, μVision™ of ARM Limited, UK. AUTOSAR™ is licensed by AUTOSAR development partnership. Bluetooth™ of Bluetooth SIG Inc. CAT-iq™ of DECT Forum. COLOSSUS™, FirstGPS™ of Trimble Navigation Ltd. EMV™ of EMVCo, LLC (Visa Holdings Inc.). EPCOS™ of Epcos AG. FLEXGO™ of Microsoft Corporation. FlexRay™ is licensed by FlexRay Consortium. HYPERTERMINAL™ of Hilgraeve Incorporated. IEC™ of Commission Electrotechnique Internationale. IrDA™ of Infrared Data Association Corporation. ISO™ of INTERNATIONAL ORGANIZATION FOR STANDARDIZATION. MATLAB™ of MathWorks, Inc. MAXIM™ of Maxim Integrated Products, Inc. MICROTEC™, NUCLEUS™ of Mentor Graphics Corporation. MIPI™ of MIPI Alliance, Inc. MIPS™ of MIPS Technologies, Inc., USA. muRata™ of MURATA MANUFACTURING CO., MICROWAVE OFFICE™ (MWO) of Applied Wave Research Inc., OmniVision™ of OmniVision Technologies, Inc. Openwave™ Openwave Systems Inc. RED HAT™ Red Hat, Inc. RFMD™ RF Micro Devices, Inc. SIRIUS™ of Sirius Satellite Radio Inc. SOLARIS™ of Sun Microsystems, Inc. SPANSION™ of Spansion LLC Ltd. Symbian™ of Symbian Software Limited. TAIYO YUDEN™ of Taiyo Yuden Co. TEAKLITE™ of CEVA, Inc. TEKTRONIX™ of Tektronix Inc. TOKO™ of TOKO KABUSHIKI KAISHA TA. UNIX™ of X/Open Company Limited. VERILOG™, PALLADIUM™ of Cadence Design Systems, Inc. VLYNQ™ of Texas Instruments Incorporated. VXWORKS™, WIND RIVER™ of WIND RIVER SYSTEMS, INC. ZETEX™ of Diodes Zetex Limited.

Last update	2011-11-11
-------------	------------

[www.infineon.com](http://www.infineon.com)

Published by Infineon Technologies AG

Downloaded From [Oneyac.com](http://Oneyac.com)

单击下面可查看定价，库存，交付和生命周期等信息

[>>Infineon Technologies\(英飞凌\)](#)