

# 100 W PFC + LCC LED driver design based on ICL5102

## 1 percent dimming with a compact LCC transformer operating with 180~450 kHz

Board sales name: REF\_ICL5102\_U100W\_LCC

Author: Yi Wang



### About this document

#### Scope and purpose

**ICL5102** is an integrated combo controller IC designed to control and drive the boost PFC + resonant half-bridge (HB) topology (LCC/LCC) combined. Two key features of this controller chip are:

1. **Great input power quality:** The superior performance of its total harmonic distortion (THD) optimizer makes it very suitable for applications with stringent requirements for the input power quality, such as LED lighting.
2. **Efficient and robust high-frequency (HF) HB driver:** Infineon's proprietary coreless-transformer-based high-side (HS) MOSFET driver is very robust against any possible hard-switching and enables efficient HB drive at operating frequency up to 500 kHz in the steady-state.

This report presents the experimental results of a 100 W PFC + LCC LED driver based on the ICL5102 controller and our cost-effective 650 V MOSFETs of the P7 series. This board design focuses on demonstrating the great power quality and the supreme HF performance of the HB driver. We fully utilize the applicable frequency range supported by this HB driver, to achieve a highly compact LCC transformer. This transformer integrates with the series inductance of the LCC resonant tank. Through this high-power density transformer design, potential to reduce system-level cost and size driven by the HF operating capability of ICL5102 is demonstrated.

#### Key features of this board:

1. A HF LCC transformer design with the series resonant inductance integrated, operating with 180 kHz at full load and with 450 kHz at the minimum load. At 450 kHz operation, the ICL5102 is less than 30°C above the ambient temperature (22°C).
2. High system efficiency with the HF operation: at full power (100 W output), the system efficiency is 93 percent at 230 V<sub>RMS</sub>/50 Hz and 91.5 percent at 120 V<sub>RMS</sub>/60 Hz.
3. 1 percent analog dimming in a wide LED voltage range (20~55 V).
4. Great input power quality:
  - a. THD less than 10 percent for load greater than 20 percent power at 267 V<sub>RMS</sub>/50 Hz
  - b. Power factor (PF) greater than 0.9 for load greater than 30 percent power at 267 V<sub>RMS</sub>/50 Hz
  - c. Harmonics fulfilling IEC61000-3-2 class C edition 5.1 for load greater than 10 percent of maximum power

#### Intended audience

This document is intended for technical experts who intend to use this ICL5102 reference board, either for ICL5102 functional tests, or as a reference for an ICL5102-based product development.



**Table of contents**

**About this document..... 1**

**Table of contents..... 2**

**1 IC introduction..... 3**

**2 Board description..... 5**

2.1 Electrical specification .....5

2.2 Schematic and layout .....6

2.3 Board setup .....10

**3 Electrical performance .....11**

3.1 System performance .....11

3.2 Steady-state waveforms .....13

3.3 Start-up behavior .....14

3.4 Load transient .....15

3.5 Protections .....15

3.5.1 Brown-out protection .....15

**4 Thermal performance .....16**

**5 EMI results.....17**

**6 Datasheets of magnetic components.....18**

**7 Bill of materials.....23**

**Revision history.....26**

# 100 W PFC + LCC LED driver design based on ICL5102

## 1 percent dimming with a compact LCC transformer operating with 180~450 kHz

### IC introduction

## 1 IC introduction

**ICL5102** is an integrated combo IC designed to drive and control the boost PFC + resonant HB topology (LCC/LCC) in combination. The normal voltage version (650 V max.) can cover the applications with universal mains up to 305  $V_{RMS}$ , while its HV version, **ICL5102HV**, can handle 980 V (max. value) on the HB driver, which is well suited to horticultural lighting applications, and other industrial applications where the input mains voltage is up to 530  $V_{RMS}$ .

Thanks to Infineon's proprietary coreless transformer technology, ICL5102/HV's HS MOSFET driver is very robust against  $dV/dt$  and potential negative voltage peak on the switch node of the HB, and moreover, it is very efficient at high operating frequency. The maximum operating frequency of the HB driver is 500 kHz in the steady-state and at extreme ambient temperatures (please refer to the datasheet for the test conditions).

The pin maps of ICL5102 and ICL5102HV are shown in **Figure 1**.

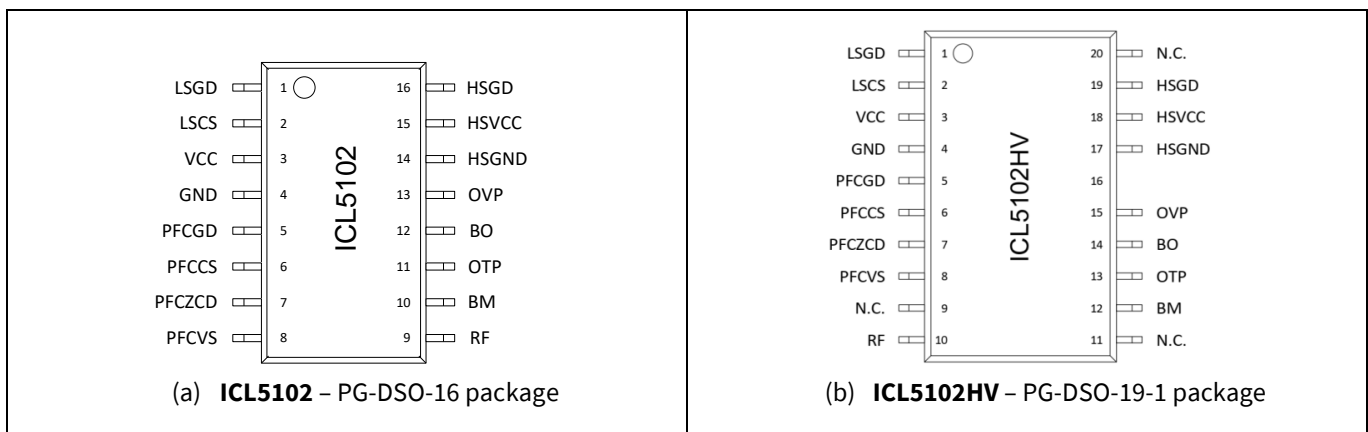

**Figure 1 Pin maps of (a) ICL5102 and (b) ICL5102HV**

ICL5102 is an integrated combo controller IC designed to control and drive the boost PFC + resonant half-bridge (HB) topology (LCC/LCC) combined. Two key features of this controller chip are:

1. **Great input power quality:** The superior performance of its total harmonic distortion (THD) optimizer makes it very suitable for applications with stringent requirements for the input power quality, such as LED lighting.
2. **Efficient and robust high-frequency (HF) HB driver:** Infineon's proprietary coreless-transformer-based high-side (HS) MOSFET driver is very robust against any possible hard-switching and enables efficient HB drive at operating frequency up to 500 kHz in the steady-state.

### Key IC features:

- Integrated two-stage combo controller, allowing for reduced number of external components, and optimized bill of materials (BOM) and form factor.
- Maximum 500 kHz HB switching frequency in continuous operation and soft-start frequency up to 1.3 MHz.
- THD optimization ensuring best-in-class THD performance and low harmonic distortion at light load. Easy to pass IEC61000-3-2 class C edition 5.1.
- PFC controller with critical conduction mode (CrCM) and discontinuous conduction mode (DCM).
- Resonant HB controller with fixed or variable switching frequency control.
- Burst mode supporting the standby mode with low power consumption (less than 500 mW, system level).
- Supports universal AC input voltage and excellent system efficiency.

# 100 W PFC + LCC LED driver design based on ICL5102

## 1 percent dimming with a compact LCC transformer operating with 180~450 kHz

### IC introduction



#### Key features of this board:

1. A HF LCC transformer design with the series resonant inductance integrated, operating with 180 kHz at full load and with 450 kHz at the minimum load. At 450 kHz operation, the ICL5102 is less than 30°C above the ambient temperature (22°C).
2. High system efficiency with the HF operation: at full power (100 W output), the system efficiency is 93 percent at 230 V<sub>RMS</sub>/50 Hz and 91.5 percent at 120 V<sub>RMS</sub>/60 Hz.
3. 1 percent analog dimming in a wide LED voltage range (20~55 V).
4. Great input power quality:
  - a) THD less than 10 percent for load greater than 20 percent power at 267 V<sub>RMS</sub>/50 Hz
  - b) Power factor (PF) greater than 0.9 for load greater than 30 percent power at 267 V<sub>RMS</sub>/50 Hz
  - c) Harmonics fulfilling IEC61000-3-2 class C edition 5.1 for load greater than 10 percent of maximum power

#### Protection coverage:

- Input brown-out protection
- PFC bus overvoltage protection (OVP)
- PFC overcurrent protection (OCP)
- Output OVP, OCP/short-circuit protection
- Output overpower/overload protection (OPP)
- HB capacitive mode protection
- Overtemperature protection (OTP)

### Board description

## 2 Board description

A 100 W LED driver demo board has been built to show the great input power quality and the excellent HB driver performance at high frequency (180~450 kHz) that can be designed with ICL5102. The board has:

- A PFC stage that operates in CrCM in the mid- and high-power range and DCM for light load.
- An LCC stage that is designed with a compact and integrated LCC transformer.
- A 0 to 10 V analog dimming interface, which enables users to check the light load performance down to 1 percent of the maximum load.

### 2.1 Electrical specification

This LED driver demo is designed to have a universal mains input and a rectangular output operation window (shown in **Figure 2**). The driver can be dimmed down via an easy-to-use 0 to 10 V analog dimming interface. With 10 V dimming voltage, the output provides approximately 1.82 A within 20~55 V output LED voltage range. With 20 V LED voltage, the drive can generate 1 W output power at low dimming voltage.

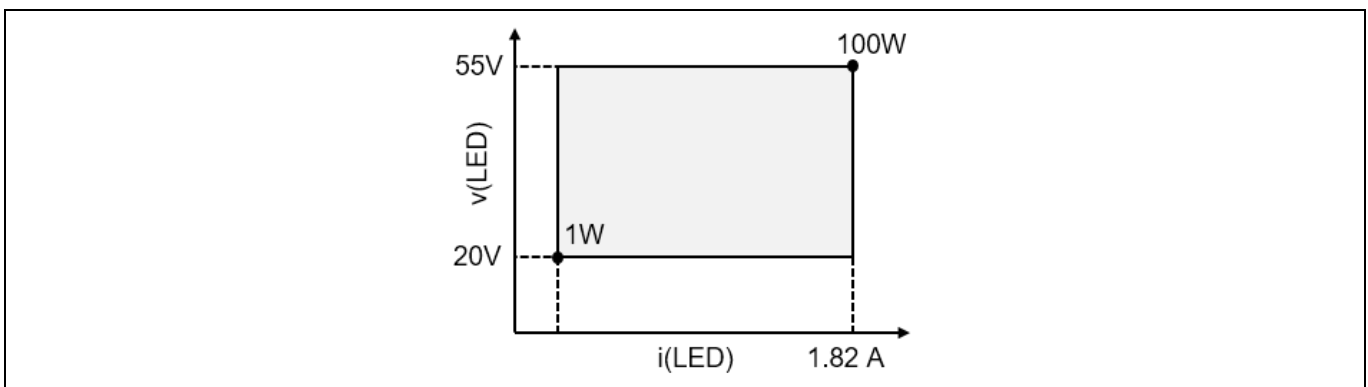

**Figure 2** Output operating window

**Table 1** lists the key electrical specifications of this demo board.

**Table 1** Key electrical specifications

Item	Symbol	Min.	Typ.	Max.	Unit	Remarks
AC input voltage	$V_{in,ac}$	90	–	267	$V_{RMS}$	
Brown-out voltage	$V_{in,BO}$	–	83	–	$V_{RMS}$	Tested 50 Hz mains
Brown-in voltage	$V_{in,BI}$	–	90	–	$V_{RMS}$	Tested 50 Hz mains
Input frequency	$f_{in}$	47	–	63	Hz	
Efficiency	$\eta$	–	93 percent	–	–	100 percent load at 230 $V_{RMS}$ , 50 Hz
Rated LED voltage	$V_{LED}$	20	–	55	V	
LED current range	$I_{LED,full}$	0.05	–	1.82	A	
Analog dimming voltage	$V_{DIM}$	0	–	10	V	
LCC frequency range	$f_{LCC}$	180*	–	450**	kHz	* $V_{LED} = 55 V$ , $V_{DIM} = 10 V$ ** $V_{LED} = 20 V$ , $V_{DIM} = 0.1 V$
Total harmonic distortion	THD	–	–	10	percent	More than 20 percent load at 267 $V_{RMS}$ , 50 Hz
Power factor	PF	0.9	–	–		More than 30 percent load at 267 $V_{RMS}$ , 50 Hz

# 100 W PFC + LCC LED driver design based on ICL5102

## 1 percent dimming with a compact LCC transformer operating with 180~450 kHz

### Board description

Item	Symbol	Min.	Typ.	Max.	Unit	Remarks
Time to light	T2L	-	-	0.5	s	
EMI	EN 55015					Tested at full load and half load
Harmonics	IEC61000-3-2 class C, edition 5.1					More than 10 percent load at 267 V <sub>RMS</sub> , 50 Hz

## 2.2 Schematic and layout

The schematic of the EMI filter, start-up and V<sub>CC</sub>, main power stage and secondary control circuit are given in [Figure 3](#) to [Figure 6](#). The PCB layout of both sides are shown in [Figure 7](#) and [Figure 8](#).

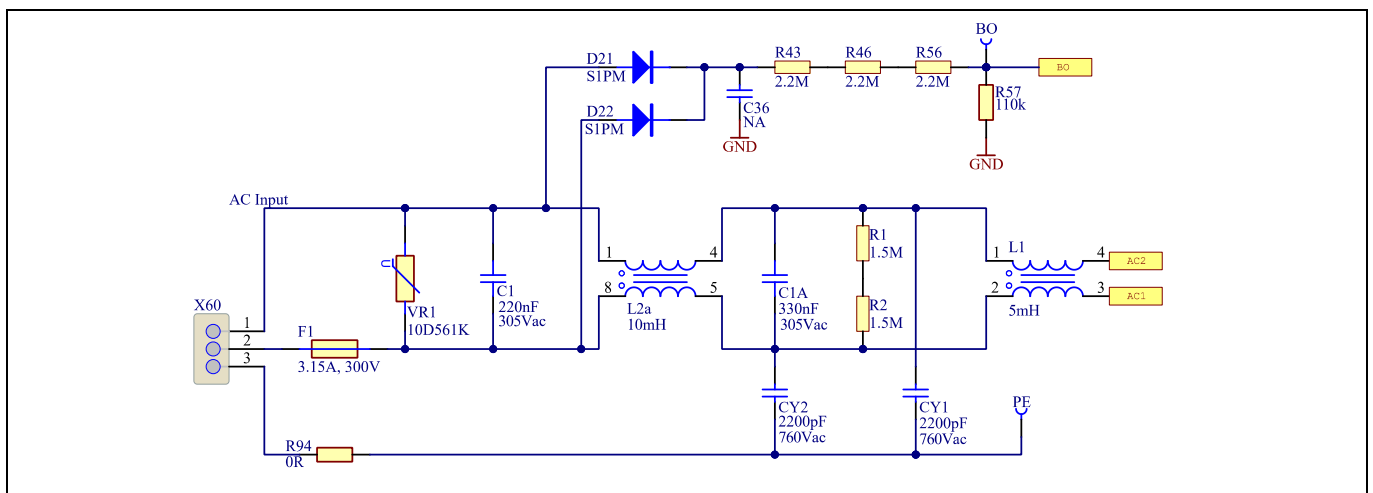

**Figure 3 Schematic of the input EMI filter part**

# 100 W PFC + LCC LED driver design based on ICL5102

## 1 percent dimming with a compact LCC transformer operating with 180~450 kHz

### Board description

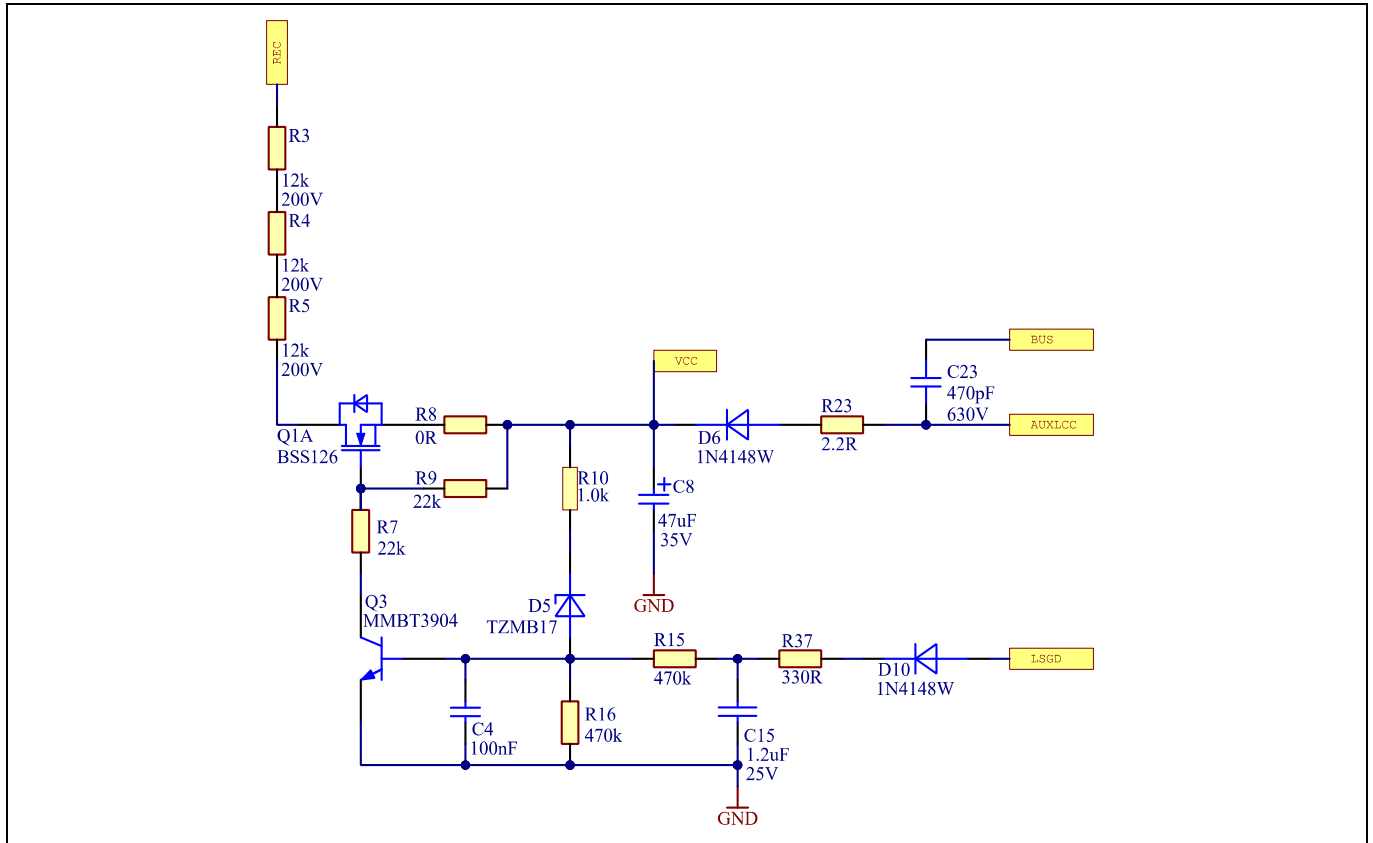

Figure 4 Schematic of the high-voltage start-up and V<sub>CC</sub> circuits

# 100 W PFC + LCC LED driver design based on ICL5102

1 percent dimming with a compact LCC transformer operating with 180~450 kHz

## Board description

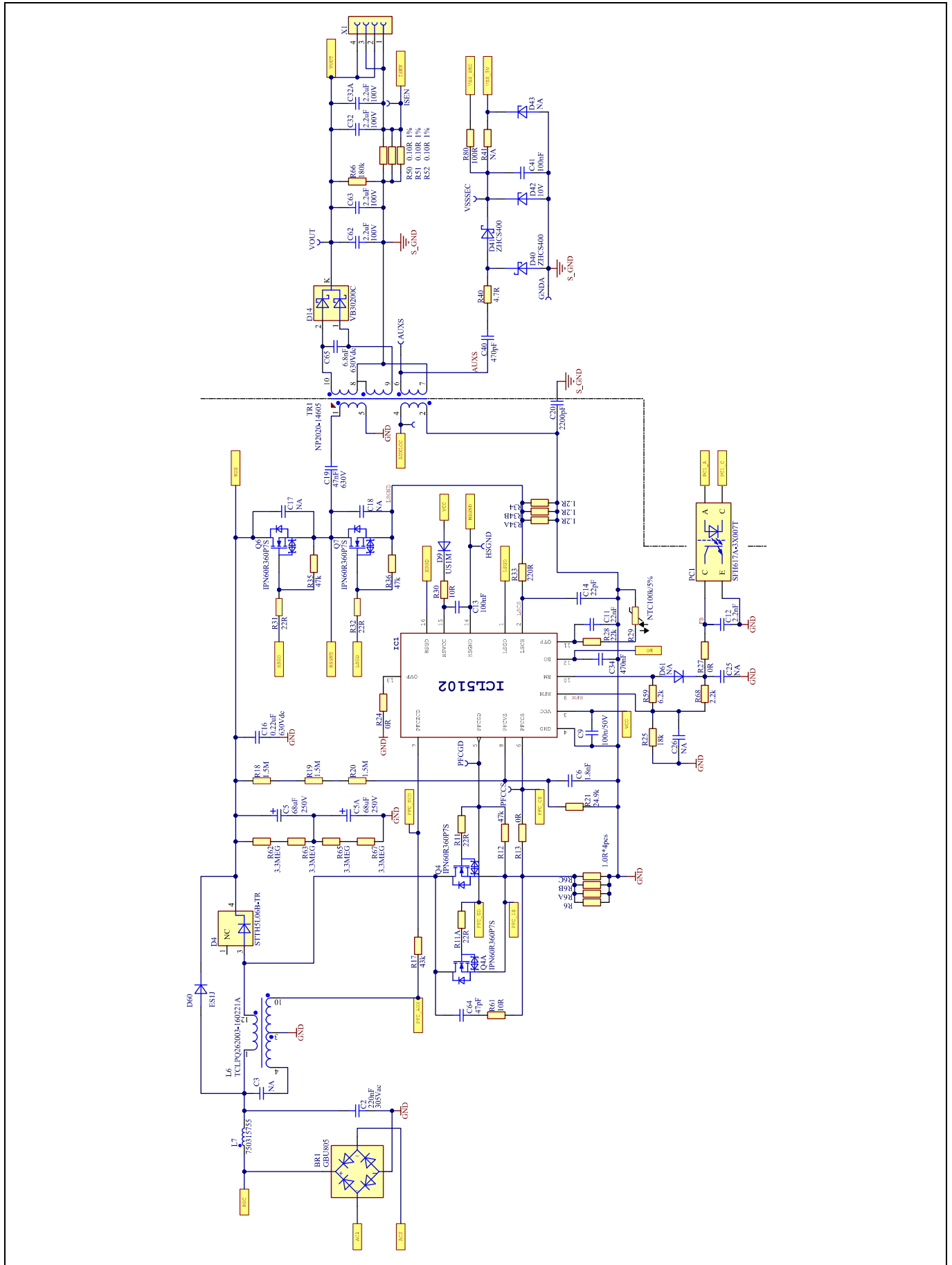

Figure 5 Schematic of the main power stage



# 100 W PFC + LCC LED driver design based on ICL5102

1 percent dimming with a compact LCC transformer operating with 180~450 kHz

## Board description

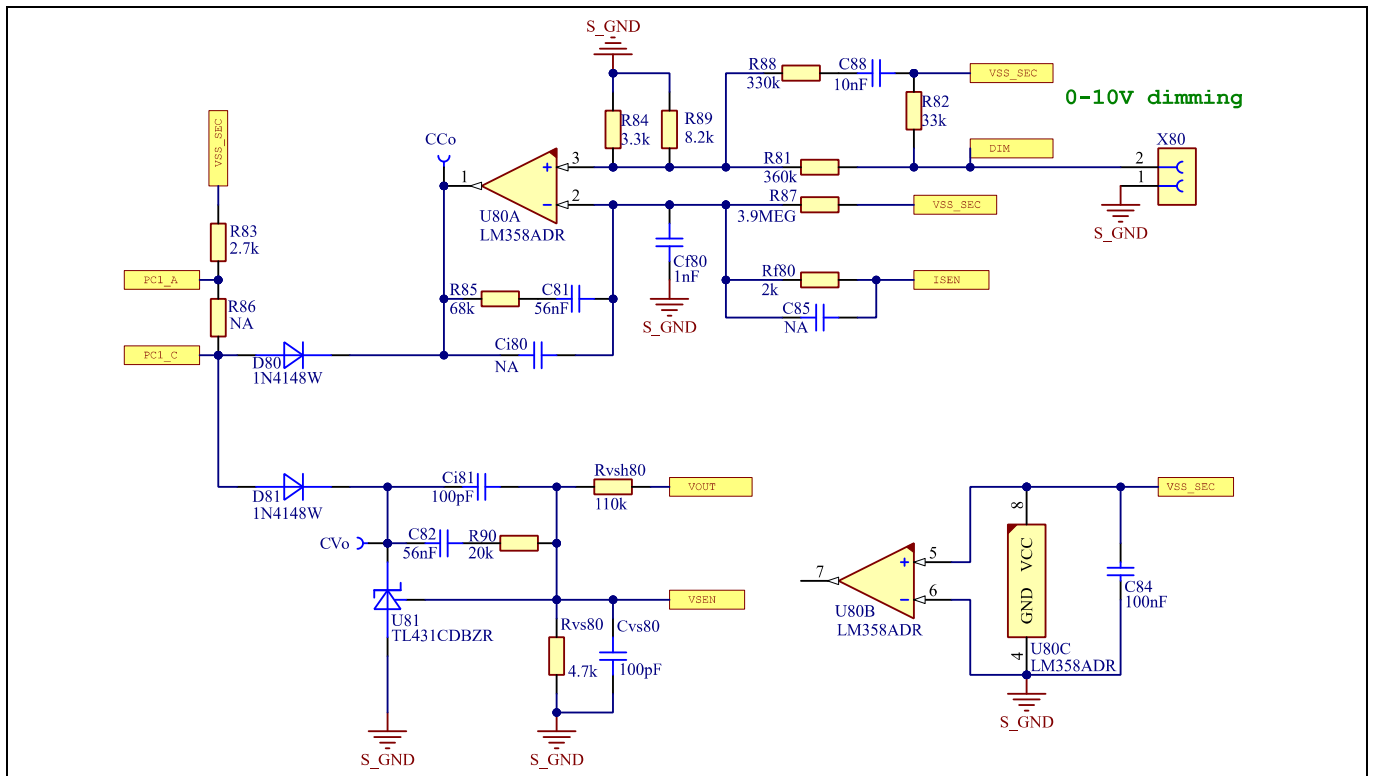

Figure 6 Schematic of the secondary control circuit

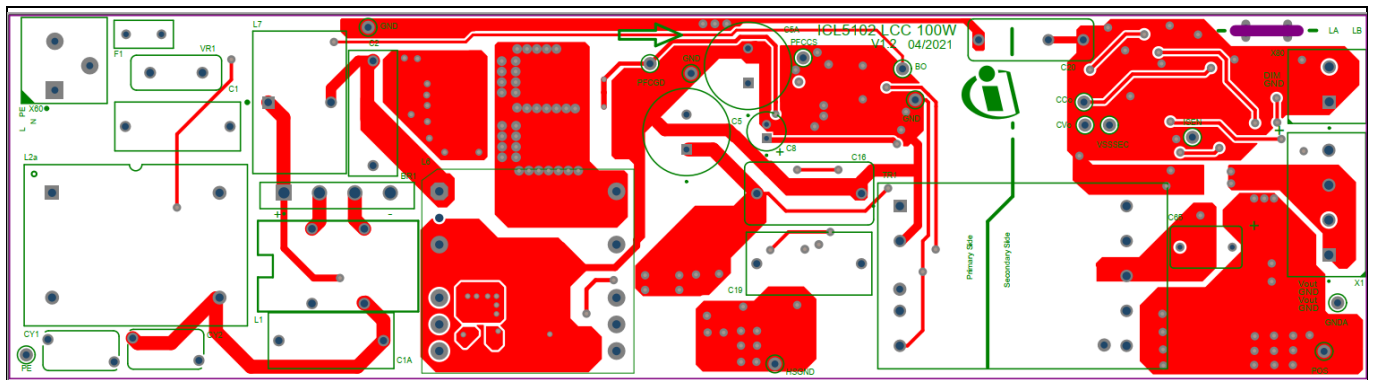

Figure 7 Layout of the through-hole component side

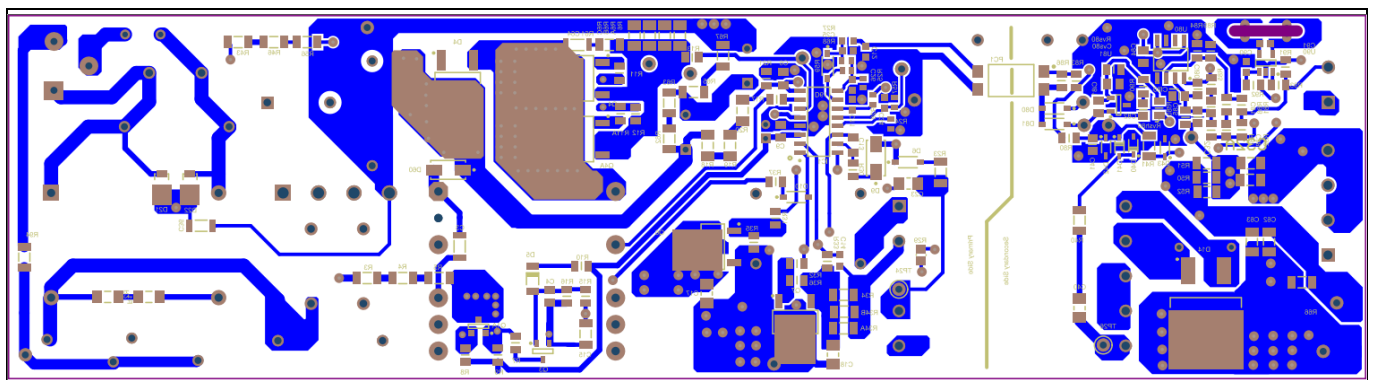

Figure 8 Layout of the SMD component side

# 100 W PFC + LCC LED driver design based on ICL5102

## 1 percent dimming with a compact LCC transformer operating with 180~450 kHz

### Board description

### 2.3 Board setup

This 18 cm long board has a two-sided PCB with 2 oz. (70  $\mu\text{m}$ ) copper thickness. An external DC voltage supply (the maximum output voltage is maximal 10 V and output current rating is at least 100 mA) should be connected to the LED side for dimming.

Here, the PFC inductor is the size of a PQ2620 core set and the integrated LCC transformer uses a special EVD25 core set, which is 5 mm longer in total than a standard EVD25 core.

The PCB and its connectors are indicated in **Figure 9a**. **Please pay attention to the connector polarities.**

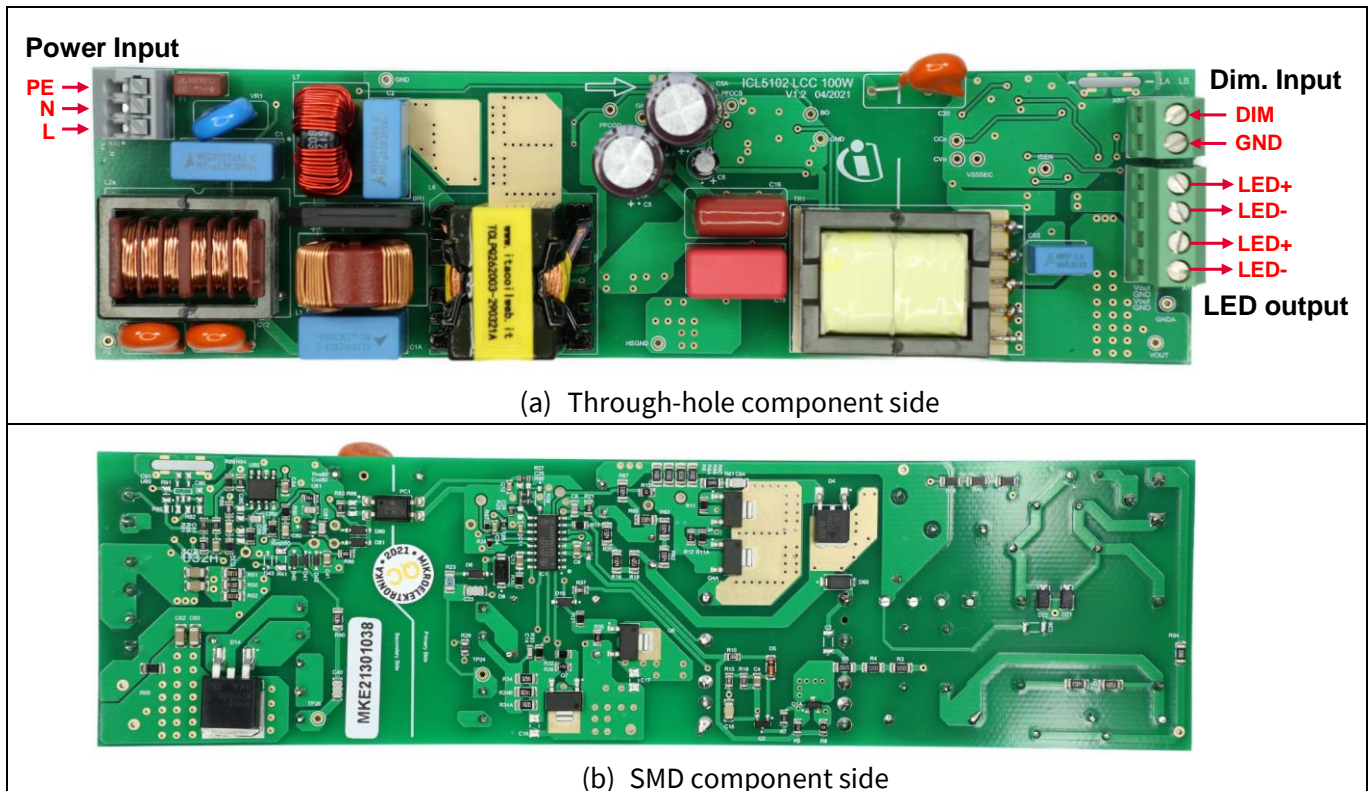

**Figure 9 Board images**

# 100 W PFC + LCC LED driver design based on ICL5102

## 1 percent dimming with a compact LCC transformer operating with 180~450 kHz

### Electrical performance

## 3 Electrical performance

The electrical performance of this board is shown below:

- System performance (LED current dimming curve, system efficiency, THD, power factor and input current harmonics)
- Steady-state waveforms
- Start-up behavior
- Load transient behavior
- Brown-out protection

### 3.1 System performance

**Figure 10** shows the dimming curves at two input voltages and with an LED string that is 55 V at the full power.

**Figure 11** illustrates the system efficiency in a wide dimming range, at two different input voltages and with two LED strings. At full power, the efficiency is around 93 percent at 230 V<sub>RMS</sub> input and 91.6 percent at 120 V<sub>RMS</sub> input.

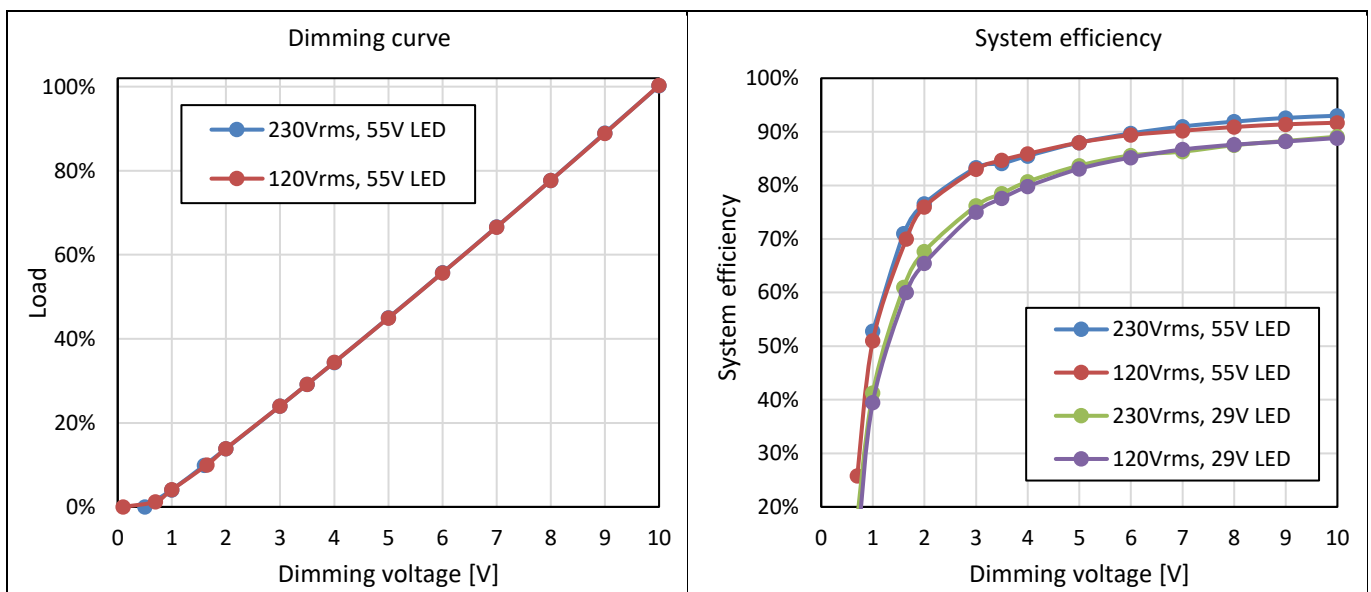

**Figure 10 LED current vs. dimming voltage**

**Figure 11 System efficiency vs. load**

The excellent power quality of this board can also be seen from the power factor, THD and input current harmonics.

**Figure 12** presents the input power factor with various loads. It shows that even at the mains condition of 267 V<sub>RMS</sub>/50 Hz (worst input case), the board can still achieve a power factor of more than 0.9 above 30 percent load.

**Figure 13** provides the THD result at various load and input conditions. It can be seen that the THD is smaller than 10 percent when load is more than 10 percent of the maximum power over the full input ranges.

**Figure 14** and **Figure 15** give the input current harmonics results at full load and 10 W load. Both fulfill the requirement of IEC61000-3-2 class C, edition 5.1. Here the input of 120 V<sub>RMS</sub> is not shown because this is an easier case to pass the harmonics requirement.

# 100 W PFC + LCC LED driver design based on ICL5102

## 1 percent dimming with a compact LCC transformer operating with 180~450 kHz

### Electrical performance

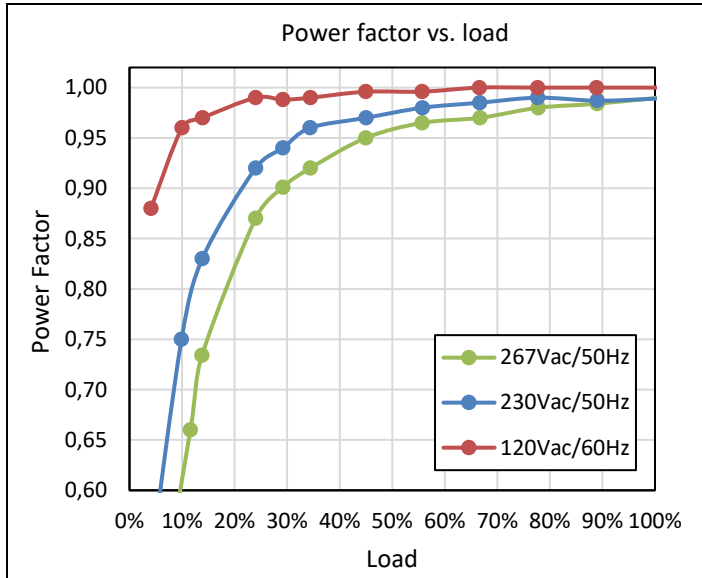

Figure 12 Power factor vs. load

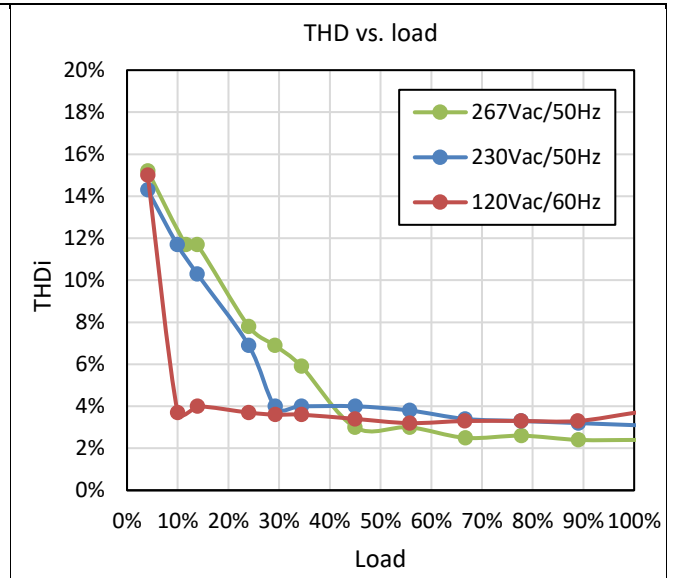

Figure 13 THD vs. load

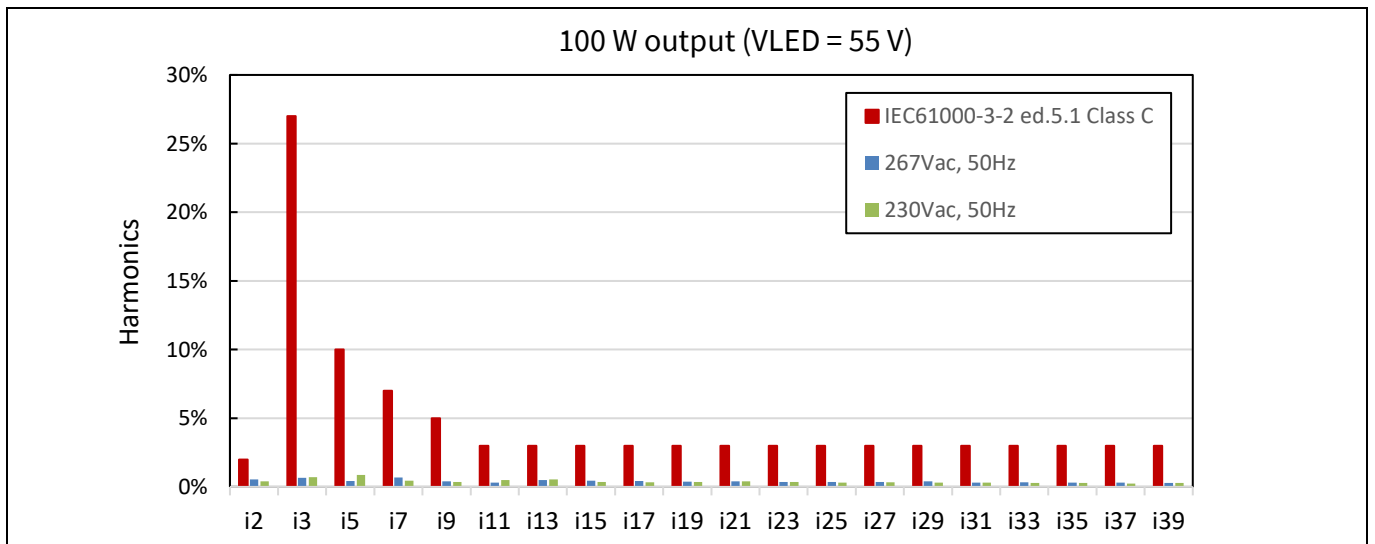

Figure 14 Input current harmonics at 100 W load

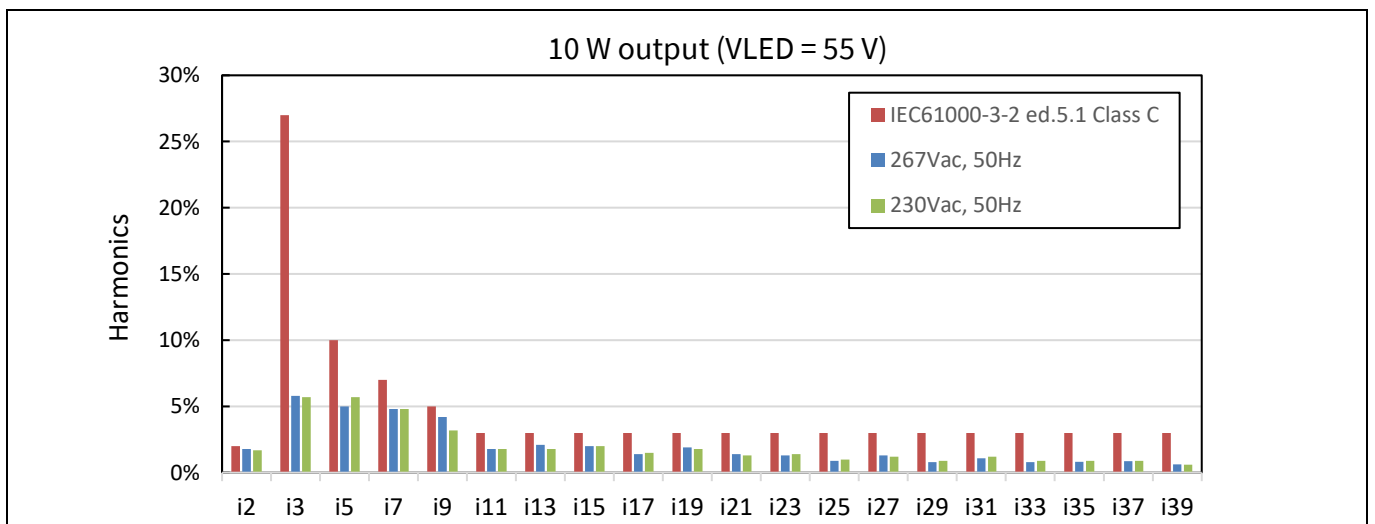

Figure 15 Input current harmonics at 10 W load



# 100 W PFC + LCC LED driver design based on ICL5102

## 1 percent dimming with a compact LCC transformer operating with 180~450 kHz

### Electrical performance

### 3.2 Steady-state waveforms

The key waveforms at various input voltages (230 V<sub>RMS</sub> and 120 V<sub>RMS</sub>), and at full load and light load, are shown in **Figure 16** to **Figure 19**. It can be seen that the PFC stays in CrCM but runs into DCM at light load. Meanwhile the input current of the LCC transformer at full power is a trapezoidal shape.

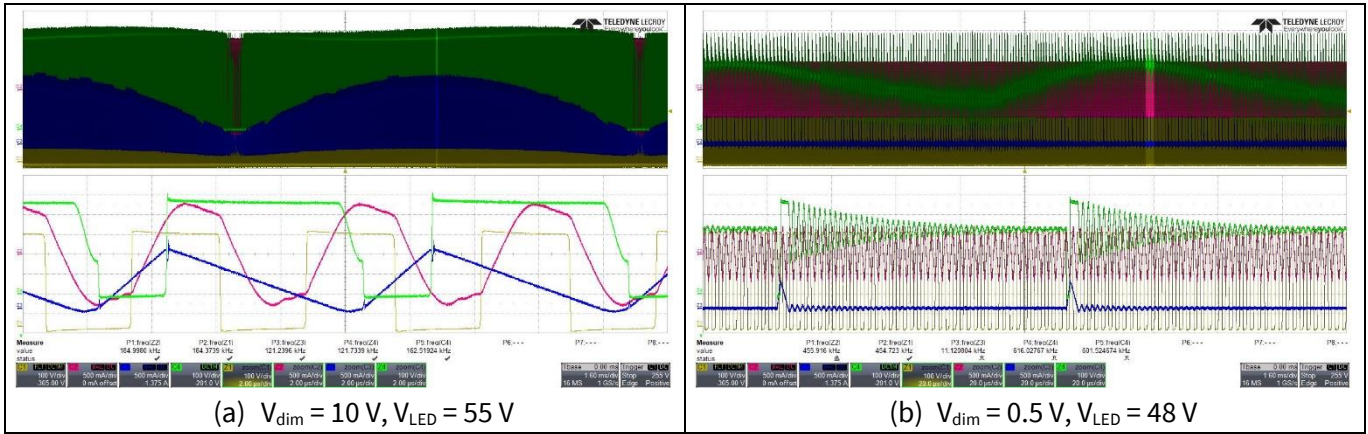

CH1: V(HSGND) 100 V/div, CH2: I(LCC transformer) 500 mA/div, CH3: I(boost inductor) 500 mA/div, CH4: V(Boost MOS DS) 100 V/div

**Figure 16 Boost and LCC waveforms with 230 V<sub>RMS</sub> input and 55 V<sub>LED</sub>**

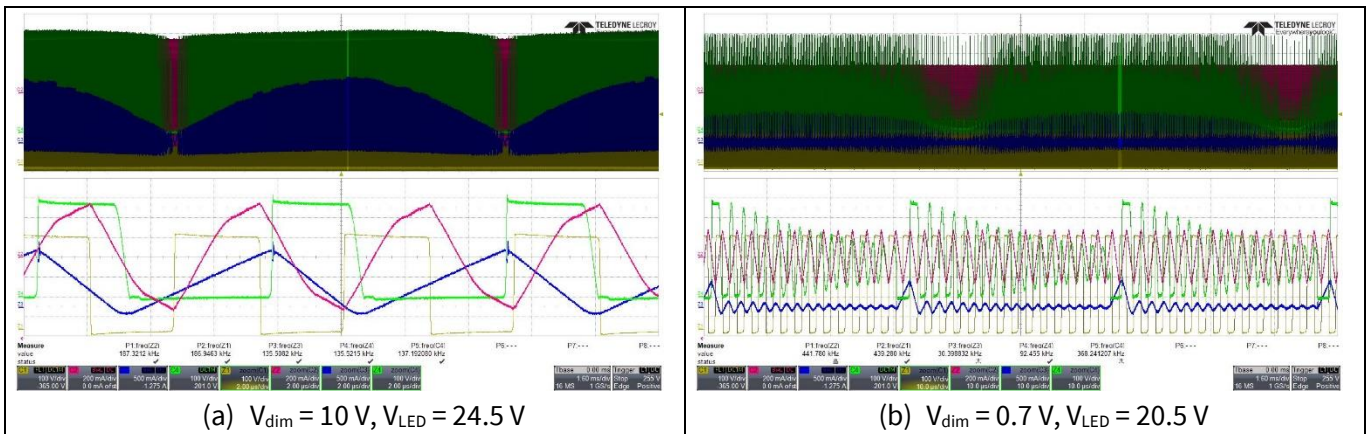

CH1: V(HSGND) 100 V/div, CH2: I(LCC transformer) 500 mA/div, CH3: I(boost inductor) 500 mA/div, CH4: V(Boost MOS DS) 100 V/div

**Figure 17 Boost and LCC waveforms with 230 V<sub>RMS</sub> input and 24.5 V<sub>LED</sub>**

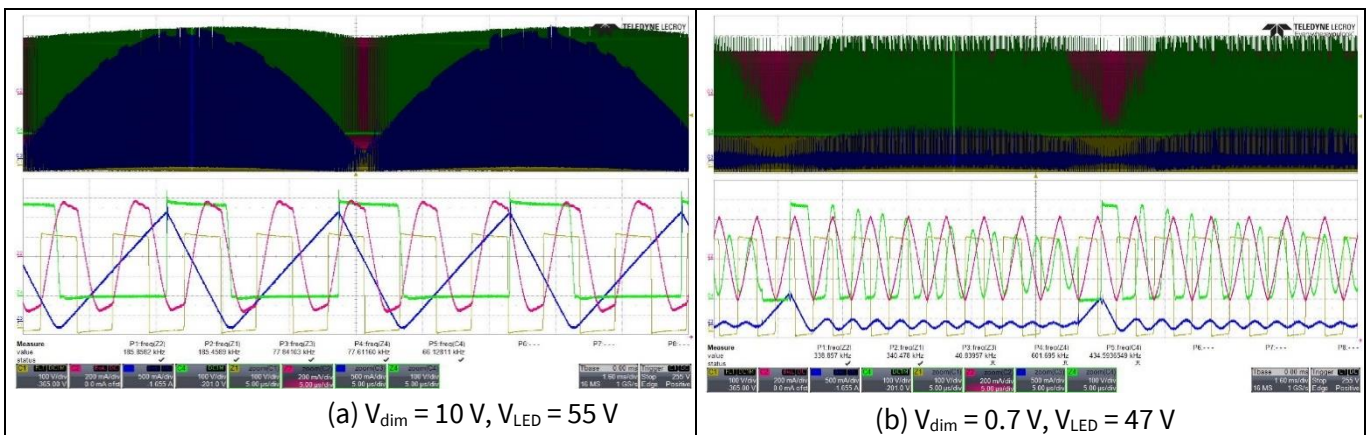

CH1: V(HSGND) 100 V/div, CH2: I(LCC transformer) 500 mA/div, CH3: I(boost inductor) 500 mA/div, CH4: V(Boost MOS DS) 100 V/div

**Figure 18 Boost and LCC waveforms with 120 V<sub>RMS</sub> input and 55 V<sub>LED</sub>**

# 100 W PFC + LCC LED driver design based on ICL5102

1 percent dimming with a compact LCC transformer operating with 180~450 kHz

## Electrical performance

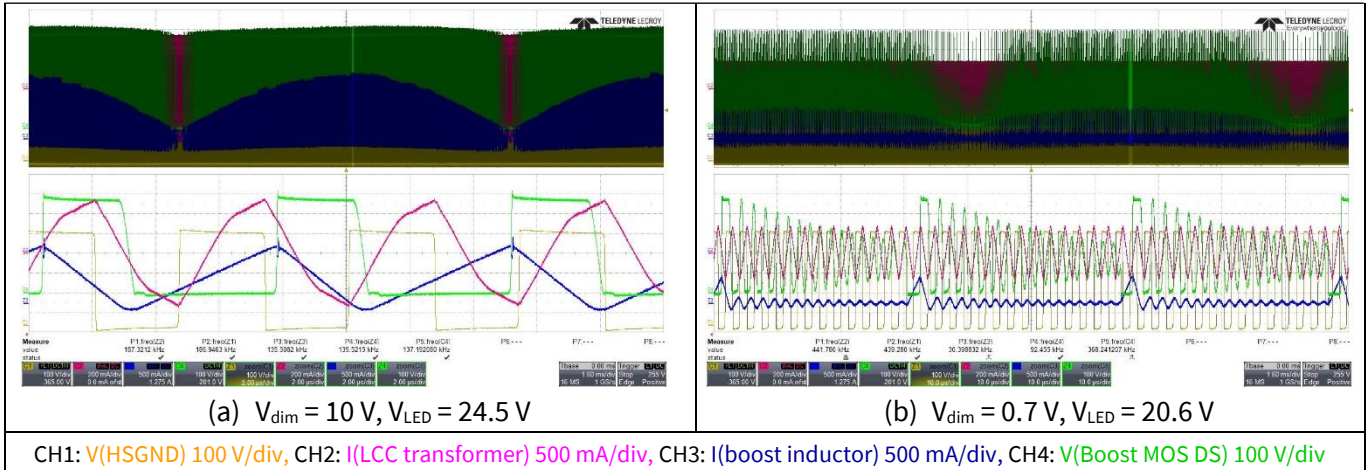

Figure 19 Boost and LCC waveforms with 120 V<sub>RMS</sub> input and 24.5 V LED

### 3.3 Start-up behavior

The start-up behavior of the V<sub>CC</sub> voltage, LED current, etc. at different input voltages, LED voltages and dimming voltages are recorded in Figure 20 (a to d). Here, the time-to-light can be observed from the V<sub>CC</sub> ramping up to the LED current ramping up.

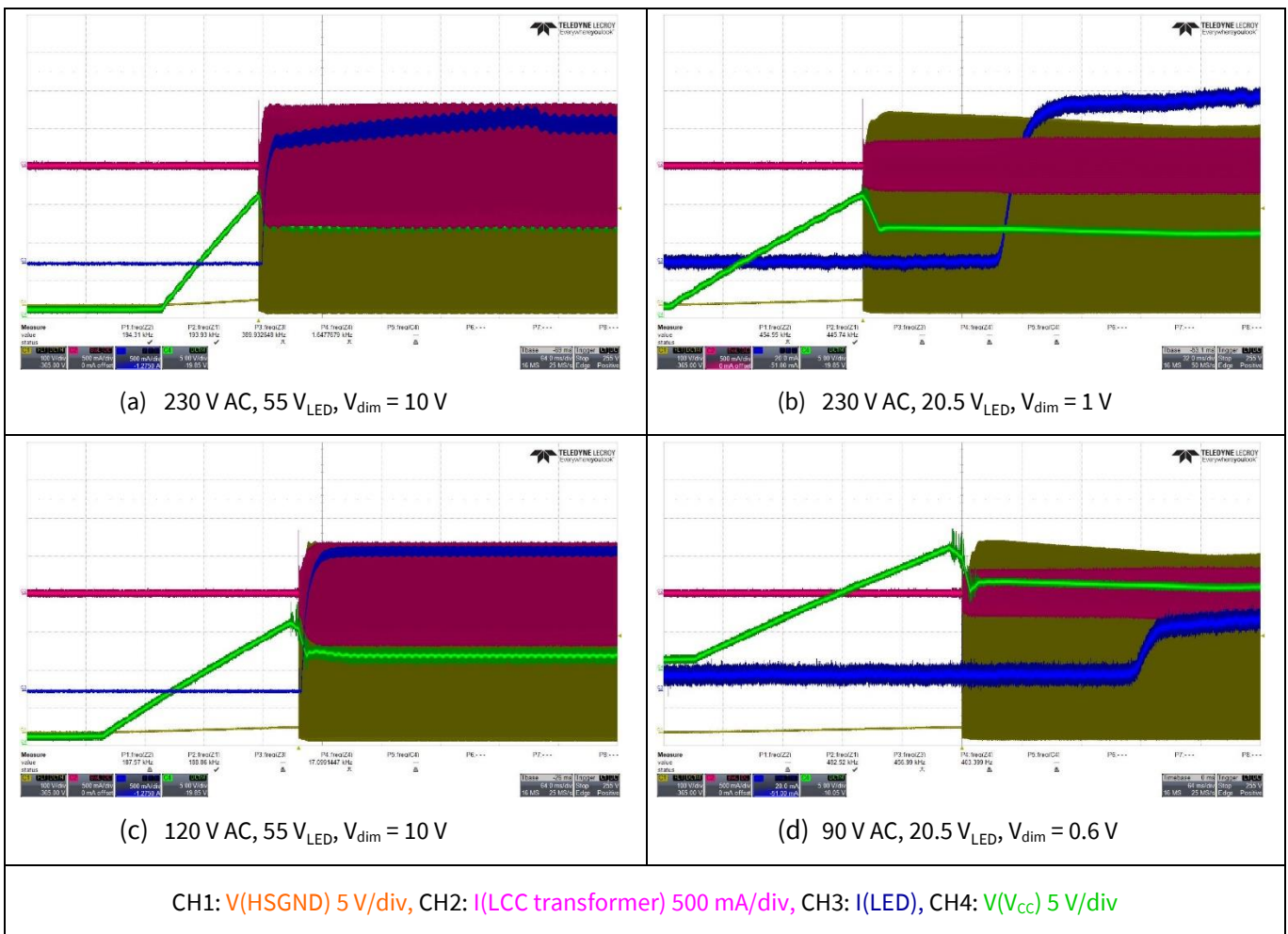

Figure 20 Start-up behavior of the V<sub>CC</sub>, LED current, LCC transformer current at different operating conditions (a to d)



# 100 W PFC + LCC LED driver design based on ICL5102

## 1 percent dimming with a compact LCC transformer operating with 180~450 kHz

### Electrical performance

### 3.4 Load transient

The figure below shows the LED current transient when the dimming voltage jumps quickly from 0.1 V to 10 V. The LED current ramps up and down smoothly.

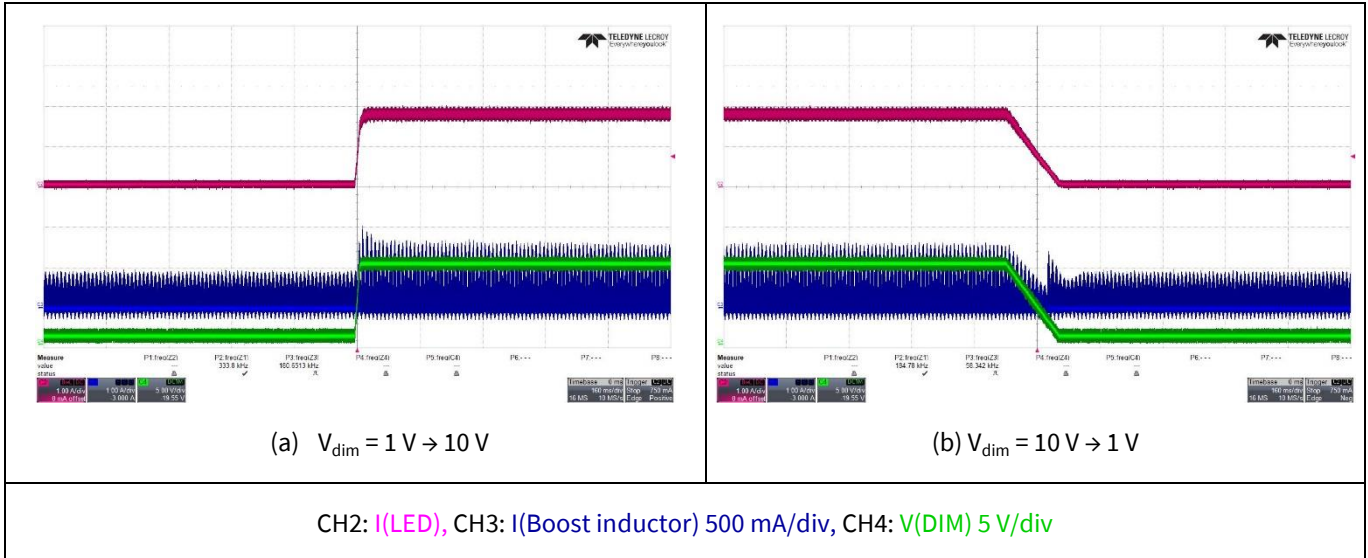

Figure 21 LED current transient behavior when  $V_{dim}$  jumps from 0.1 V to 10 V

### 3.5 Protections

#### 3.5.1 Brown-out protection

The external resistors and capacitors around the brown-out pin are tuned such that the brown-out protection is triggered around 83  $V_{RMS}$  and brown-in around 90  $V_{RMS}$ .

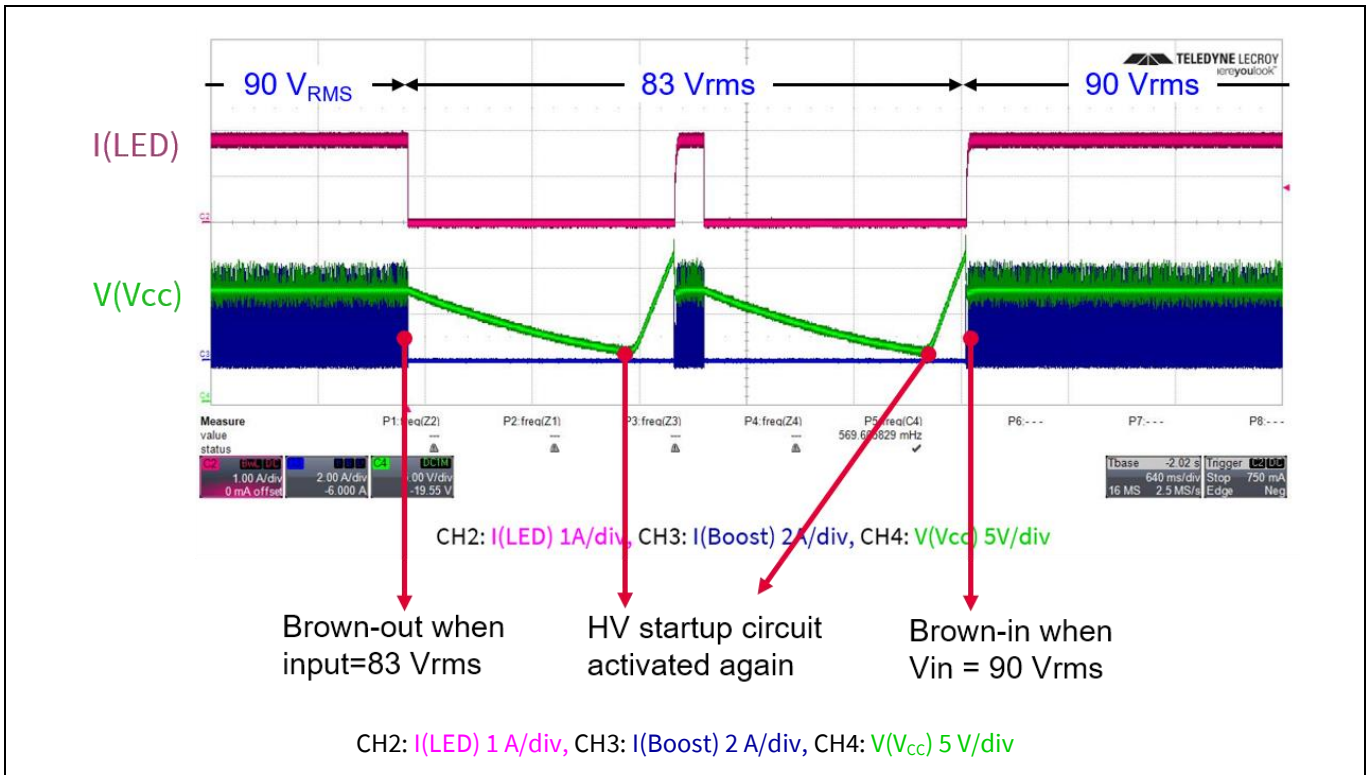

Figure 22 Brown-out protection

# 100 W PFC + LCC LED driver design based on ICL5102

## 1 percent dimming with a compact LCC transformer operating with 180~450 kHz

### Thermal performance

## 4 Thermal performance

The infrared image in **Figure 23** shows the temperature profile of this board at full power and 230 V<sub>RMS</sub> input. The ambient temperature is 22°C. The hot spot locations have been painted with a thin layer of material with emissivity close to 1. A two-diodes-in-one package VB30200C is used here; the heat is quite concentrated. This diode could be replaced with two discrete diodes, to spread the heat wider and hence lower the temperature rise in the output diodes and also in the LCC transformer.

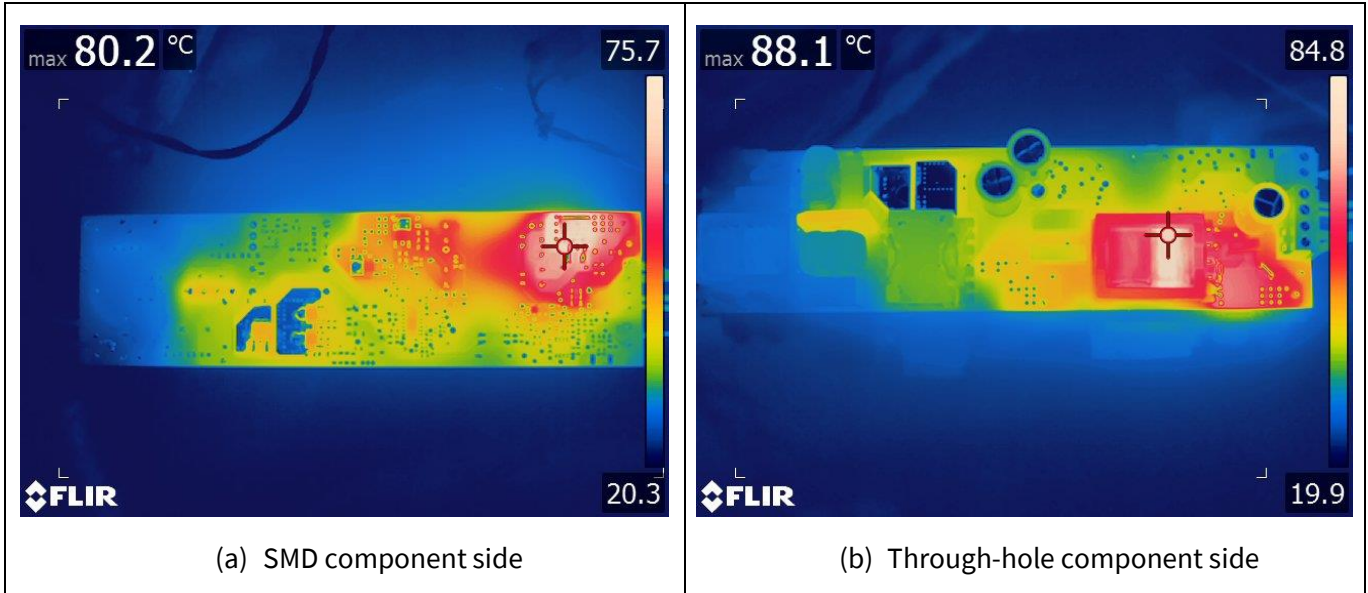

**Figure 23** Infrared image of the board at 230 V<sub>RMS</sub> and 100 W (ambient temperature 22°C)

The LCC operates around 450 kHz to reach 1 percent load at 21 V LED. ICL5102 with the coreless-transformer-based HS driver is still very cool, only 50°C, less than 30°C above the ambient temperature. **Figure 24 (b)** shows the infrared picture of the IC side in such a situation. In this picture, the hot spot is actually the current-limiting resistor in front of the bootstrap V<sub>CC</sub> capacitor. Please keep in mind that the bus voltage here is around 450 V. This evidence shows how efficient our integrated HS driver can be at high-frequency operation. Users can utilize this feature to design a very compact LLC or LCC stage.

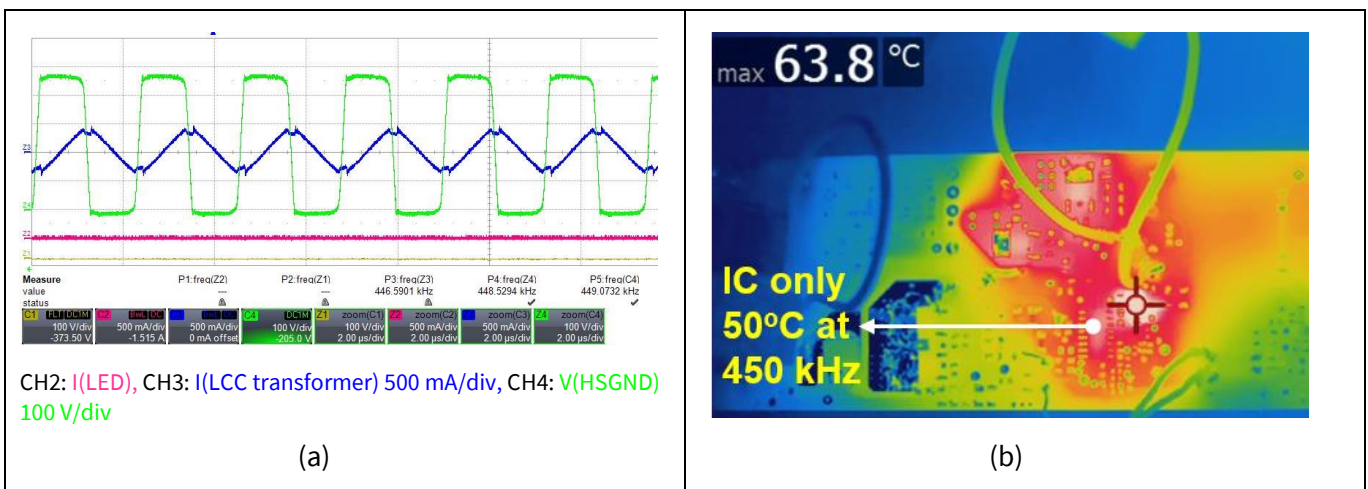

**Figure 24** Thermal performance at 447 kHz and 1 W: (a) waveforms at 1 W and 21 V<sub>LED</sub> (b) infrared board picture



# 100 W PFC + LCC LED driver design based on ICL5102

## 1 percent dimming with a compact LCC transformer operating with 180~450 kHz

### EMI results

## 5 EMI results

An EMI filter has been carefully designed for this HF LED driver, in order to realize a considerable margin under the quasi-peak and average limitation defined in EN 55015 table 2a. The filter capacitors have also been tuned to support an excellent input power quality. The items of test equipment involved are:

- Real-time spectrum analyzer: RSA503A (Tektronix)
- LISN: NSLK 8126 – Schwazbeck Mess-Elektronik
- Transient limiter in front of the spectrum analyzer: GPL 5010 – GW Instek

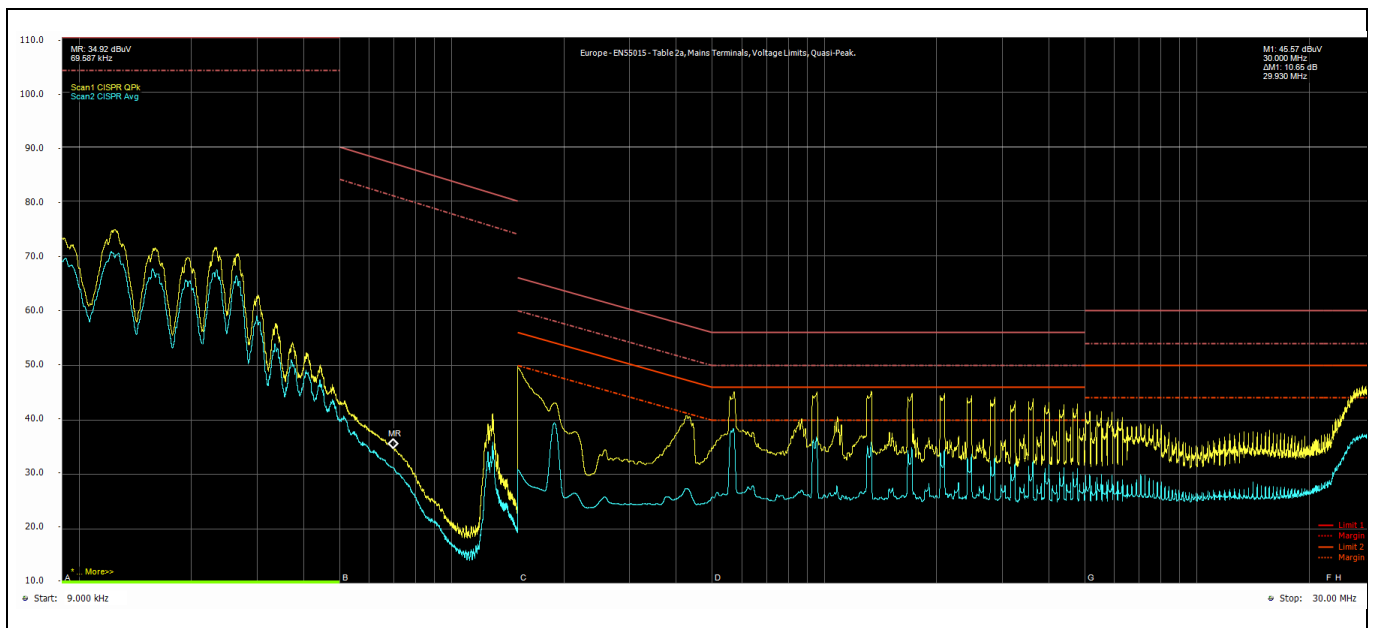
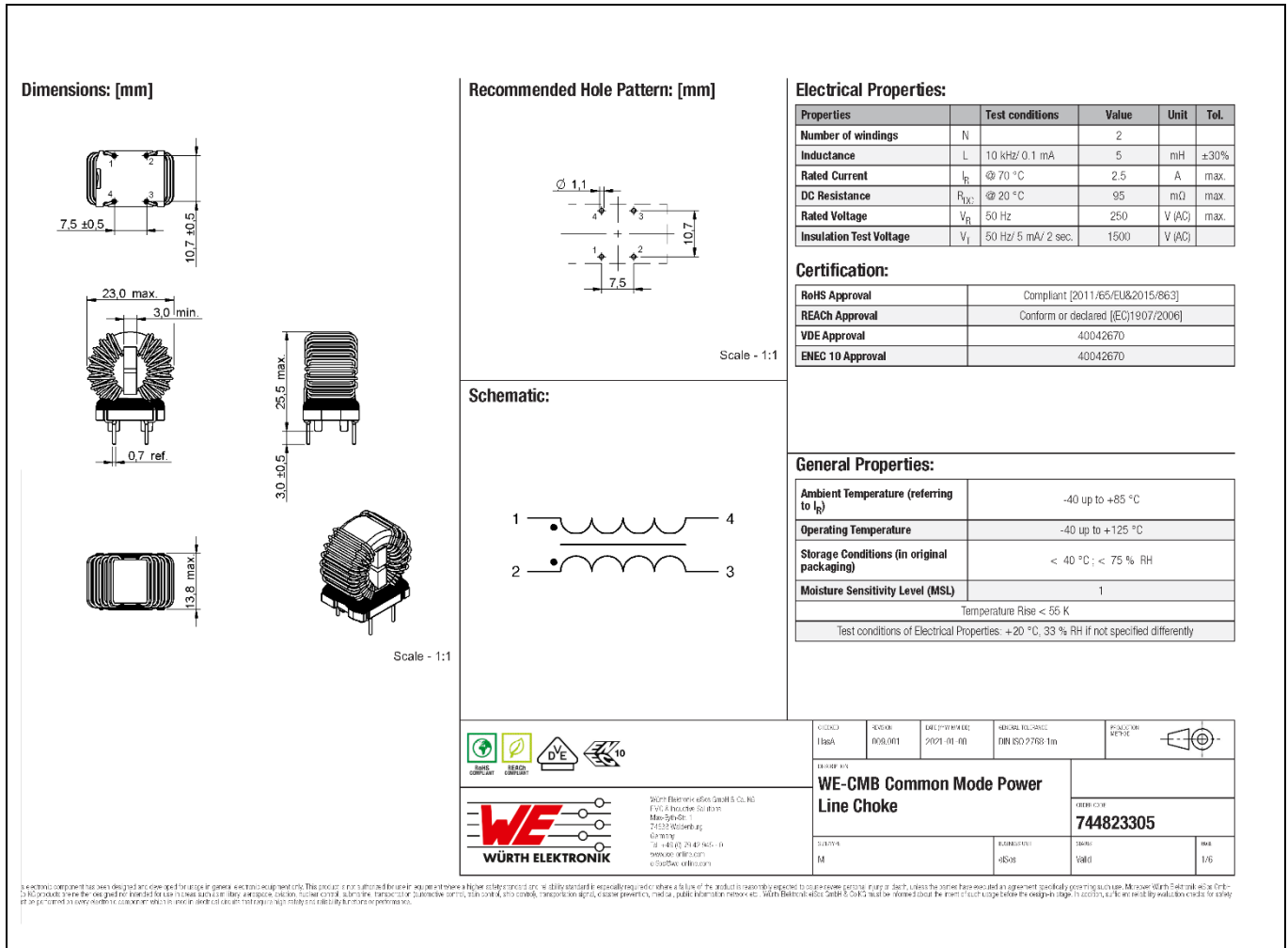

**Figure 25** Conducted EMI at 230 V AC and 100 W output

**100 W PFC + LCC LED driver design based on ICL5102**  
**1 percent dimming with a compact LCC transformer operating with 180~450 kHz**  
**Datasheets of magnetic components**

## 6 Datasheets of magnetic components

The datasheets of the magnetic components involved are shown below. These are two common mode chokes, one differential mode choke, the boost inductor and the LCC transformer.

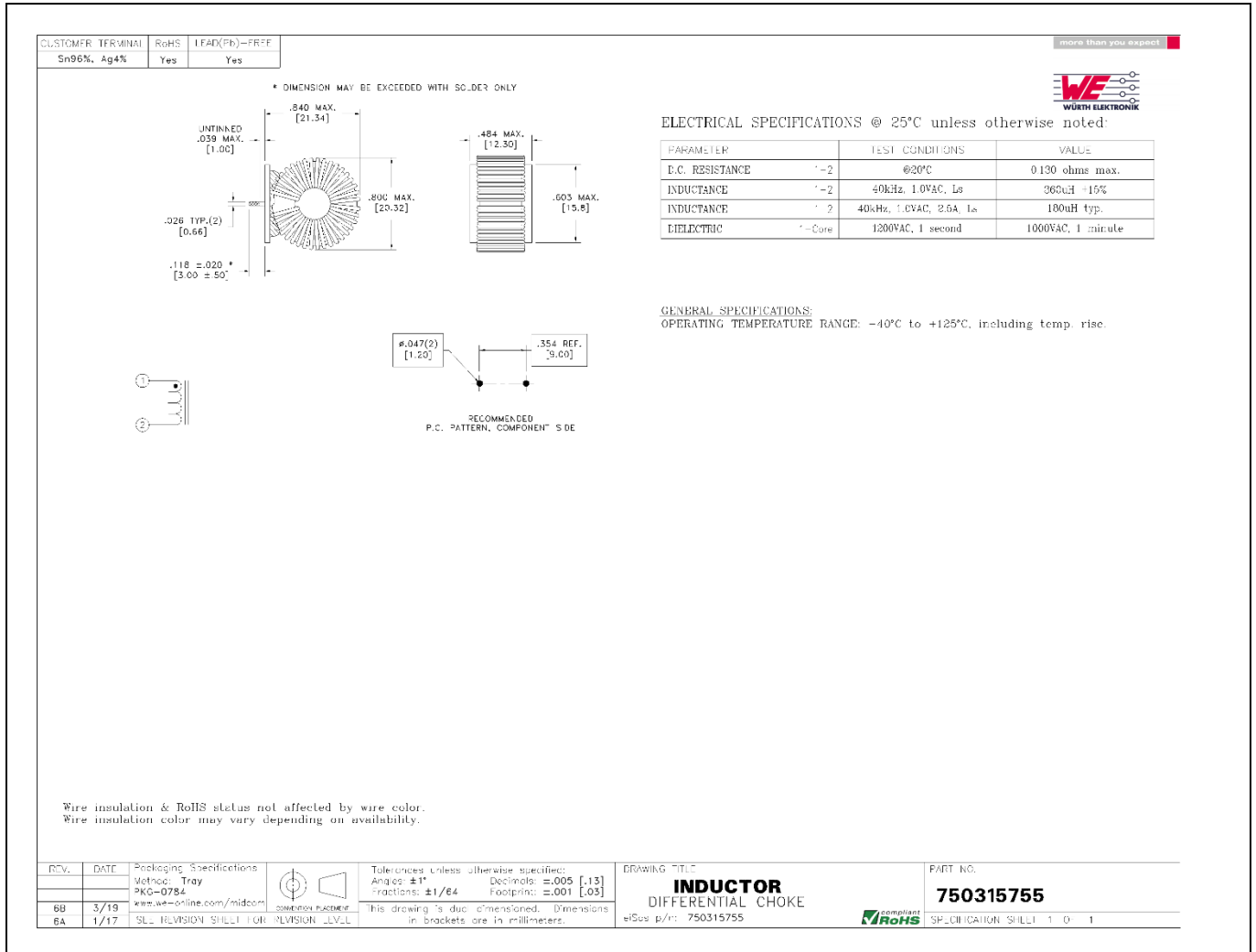

**Figure 26 Common mode EMI choke – L1**

# 100 W PFC + LCC LED driver design based on ICL5102

## 1 percent dimming with a compact LCC transformer operating with 180~450 kHz

### Datasheets of magnetic components



**Figure 27 Differential mode EMI choke – L7**

# 100 W PFC + LCC LED driver design based on ICL5102

1 percent dimming with a compact LCC transformer operating with 180~450 kHz

Datasheets of magnetic components

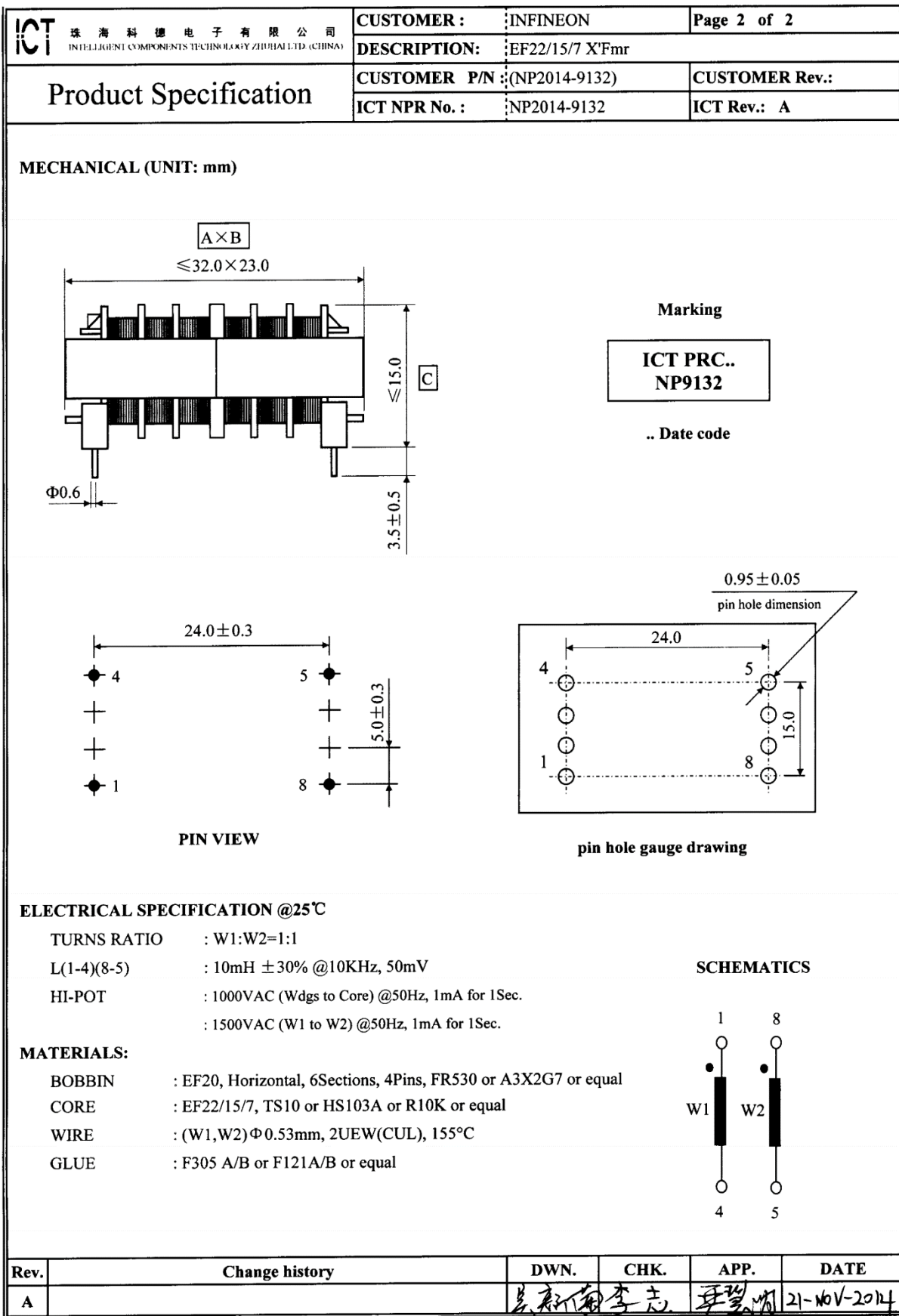
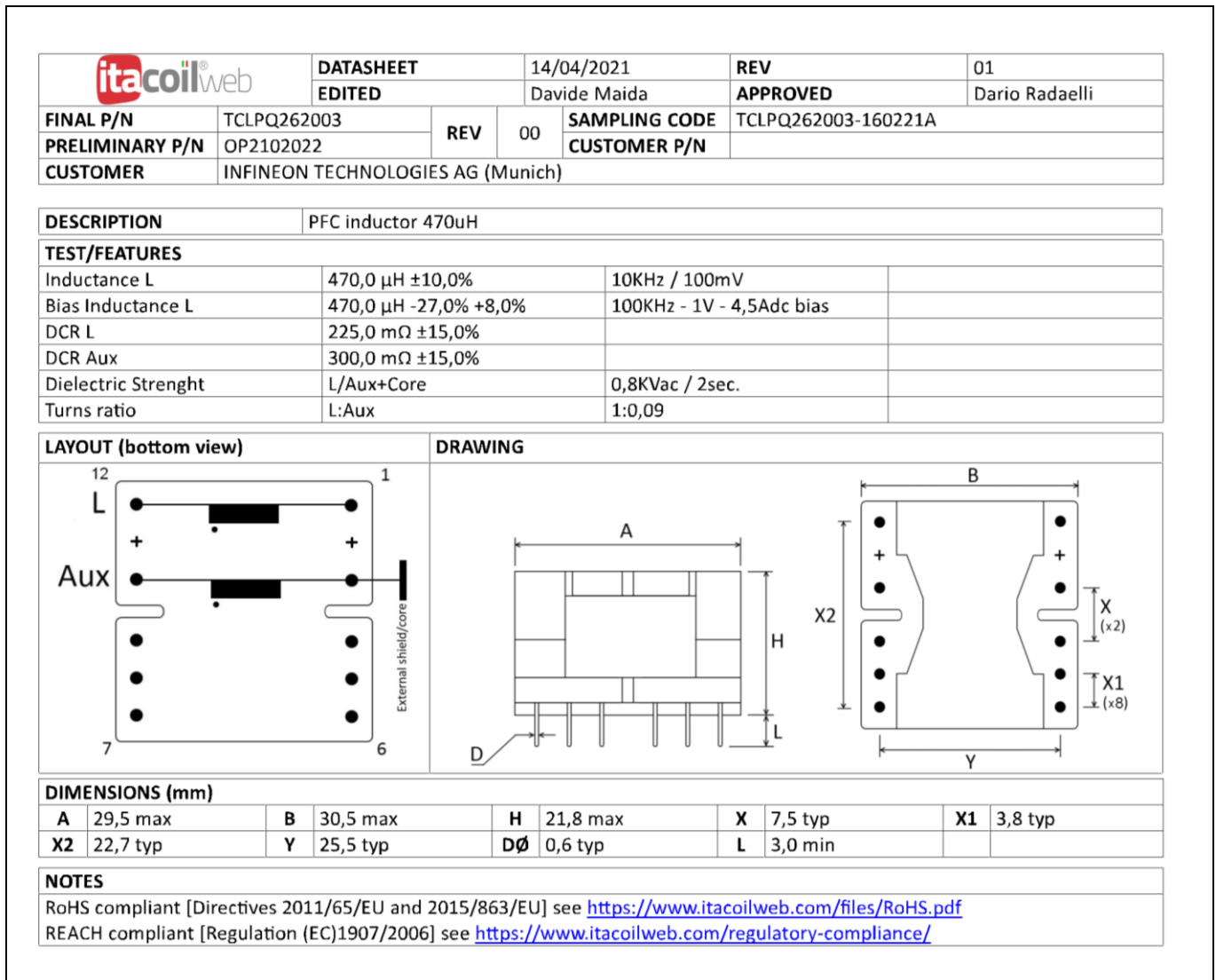

Figure 28 Common mode EMI choke – L2a

**100 W PFC + LCC LED driver design based on ICL5102**  
**1 percent dimming with a compact LCC transformer operating with 180~450 kHz**  
**Datasheets of magnetic components**



**Figure 29 Boost inductor – L6**

# 100 W PFC + LCC LED driver design based on ICL5102

1 percent dimming with a compact LCC transformer operating with 180~450 kHz

Datasheets of magnetic components

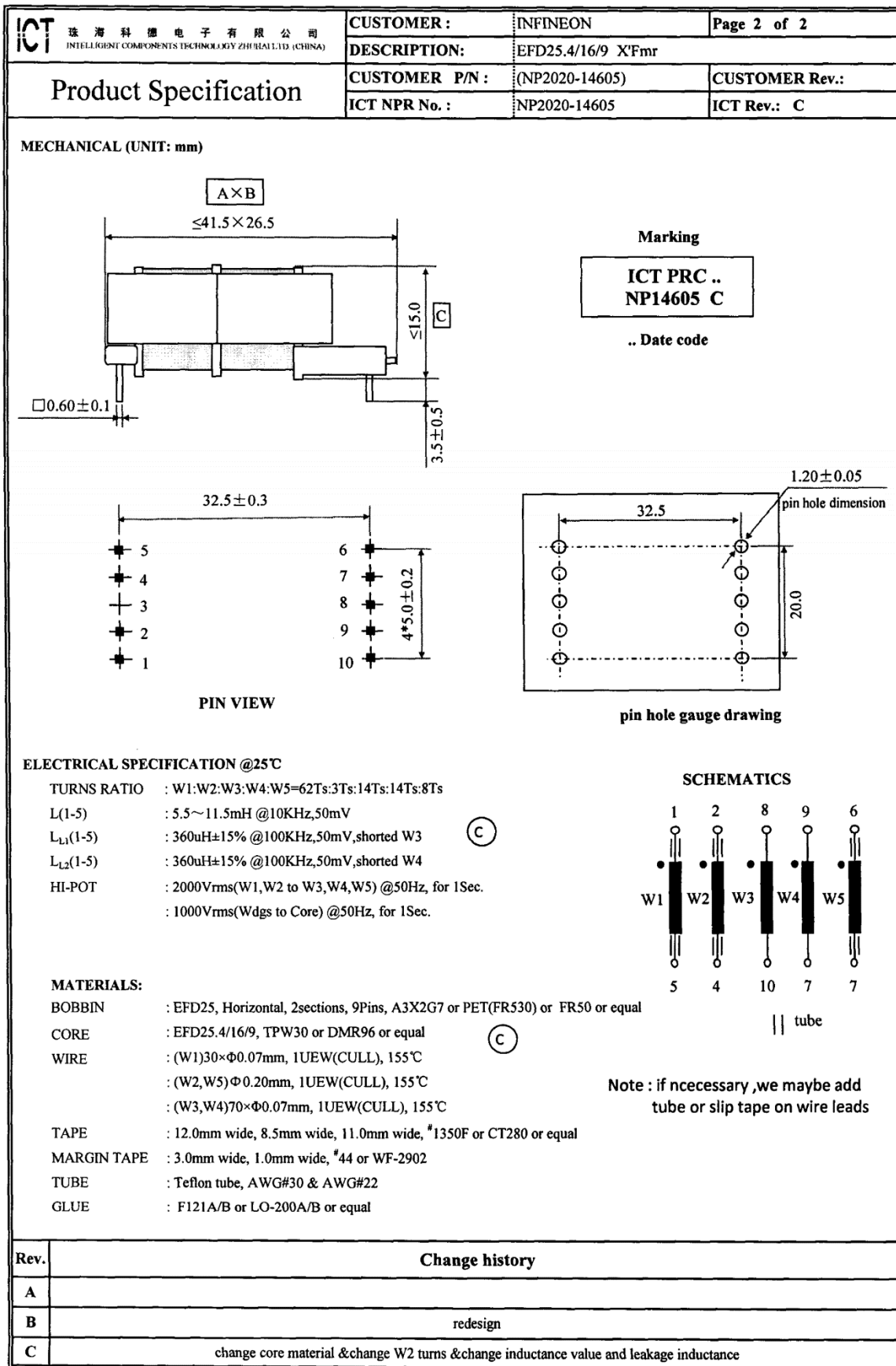

Figure 30 LCC transformer – TR1

# 100 W PFC + LCC LED driver design based on ICL5102

1 percent dimming with a compact LCC transformer operating with 180~450 kHz

Bill of materials



## 7 Bill of materials

Qty	Designator	Description	Manufacturer	Manufacturer's part no.
1	Ant	ANT 14x11.5		
1	BR1	GBU805/600 V/SIP-4	Taiwan Semiconductor	GBU805 D2
2	C1, C2	Capacitor 220 nF/305 V AC/radial type/10%	Epcos	B32922C3224K
1	C1A	Capacitor 330 nF/305 V AC/radial type/10%	Epcos	B32922C3334M189
4	C4, C9, C13, C84	Capacitor 100 n/50 V/0805/X7R/10%	TDK	C2012X7R1H104K085AA
2	C5, C5A	Capacitor 68 µF/250 V/ CAPPRD500W60D1275H2700B/20%	Nichicon	UCY2E680MHD
1	C6	Capacitor 1.8 nF/50 V/0805/C0G/5%	Murata	GCM2165C1H182JA16
1	C8	Capacitor 47 µF/35 V/radial type/20%	Rubycon	35PX47MEFC5X11
1	C11	Capacitor 22 nF/50 V/0603/X7R/10%	Murata	GRM188R71H223KA01
1	C12	Capacitor 2.2 nF/25 V/0603/X7R/10%	Murata	GCM188R71E222KA37
1	C14	Capacitor 22 pF/50 V/0603/C0G/5%	Murata	GRM1885C1H220JA01
1	C15	Capacitor 1.2 µF/25 V/1206/X7R/10%	AVX	12063C224K4Z2A
1	C16	Capacitor 0.22 µ/630 V DC/ CAPRR1500W80L1850T900H1750B/5%	Panasonic	ECQE6224JF
1	C19	Capacitor 47 nF/630 V/CAP-THT-FKP4_15P-9x16x18/10%	WIMA	FKP4J024704J00KSSD
1	C20	Capacitor 2200 p/760 V AC/disk, pitch 10-15/Y5U/20%	Vishay	440LD22-R
2	C23, C40	Capacitor 470 pF/630 V/1206/C0G/5%	TDK Corporation	CGA5F4C0G2J471J085AA
4	C32, C32A, C62, C63	Capacitor 2.2 µF/100 V/1206/X7R/10%	Murata	GRM31CR72A225KA73
1	C34	Capacitor 470 nF/25 V/0603/X7R/10%	Murata	GCM188R71E474KA64
1	C41	Capacitor 100 nF/50 V/0805/X7R/10%	Murata	GRM21BR71H104KA01
1	C64	Capacitor 47 pF/630 V/1206/C0G/5%	Murata	GRM31A5C2J470JW01
1	C65	Capacitor 6.8 nF/630 V DC/radial type/5%	TDK Corporation	B32620A6682
2	C81, C82	Capacitor 56 nF/50 V/0805/X7R/10%	Murata	GRM21BR71H563KA01
1	C88	Capacitor 10 nF/50 V/0805/X7R/10%	Murata	GRM216R71H103KA01
1	Cf80	Capacitor 1 nF/50 V/0805/C0G/5%	Murata	GRM2165C1H102JA01
2	Ci81, Cvs80	Capacitor 100 pF/50 V/0805/C0G/5%	Murata	GCM2165C1H101JA16
2	CY1, CY2	2200 p/760 V AC/ CAPRR950W81L1090T570H1410B/Y5U/20%	Vishay	440LD22-R
1	D4	STTH5L06B-TR/30 V/DPAK-3	STM	STTH5L06B-TR
1	D5	TZMB17/17V/SOD-80C	Vishay	TZM5247B-GS18
4	D6, D10, D80, D81	Diode 1N4148W/SOD-123	Diodes Incorporated	1N4148W-7-F
1	D9	Diode US1M/1000 V/DO-214AC (SMA)	Vishay	US1M-E3/61T
1	D14	Diode MBRB20200CTT4G/200 V/20 A/D2PAK (TO-263AB) is used in this demo, but Diode VB30200C/200 V/30 A/D2PAK (TO-263AB) is also ok.	Vishay Onsemi	VB20200C-E3/4W MBRB20200CTT4G
2	D21, D22	Diode S1PM/1 kV/DO-220AA	Vishay	S1PM-M3/84A
2	D40, D41	Diode ZHCS400/SOD-323	Diodes Incorporated	ZHCS400



# 100 W PFC + LCC LED driver design based on ICL5102

## 1 percent dimming with a compact LCC transformer operating with 180~450 kHz



### Bill of materials

1	D42	Diode 10 V/SOD-323	Diodes Incorporated	BZT52C10SQ-7-F
1	D60	Diode ES1J/SMA (DO-214AC)	Onsemi	ES1J
1	F1	Diode 3.15 A/300 V/ FUSRR508W60L850T400H800B	Littelfuse	36913150000
<b>1</b>	<b>IC1</b>	<b>ICL5102/PG-DSO-16</b>	<b>Infineon</b>	<b>ICL5102</b>
1	L1	Inductor 5 mH/WE-CMB Type M	Würth Elektronik	744823305
1	L2a	Inductor 10 mH/EF22/15/7	ICT	NP2014-9132
1	L6	Inductor TCLPQ262003-160221A/PQ26	Itacoil	TCLPQ262003-160221A
1	L7	Inductor 180 µH/THT	Würth Elektronik	750315755
2	LA, LB	Connector testpad_1mm	Samtec	
1	PC1	SFH617A-3X007T/SMD-4, 1016LS254P650W458L440H	Vishay	SFH617A-3X007T
1	PCB	PCB		
<b>1</b>	<b>Q1A</b>	<b>BSS126/PG-SOT-23-3-5</b>	<b>Infineon Technologies</b>	<b>BSS126</b>
1	Q3	MMBT3904/SOT-23-3	NXP Semiconductors	MMBT3904,215
<b>4</b>	<b>Q4, Q4A, Q6, Q7</b>	<b>Transformer IPN60R360P7S/600 V/9 A/PG-SOT-223</b>	<b>Infineon Technologies</b>	<b>IPN60R360P7S</b>
5	R1, R2, R18, R19, R20	Resistor 1.5 M/200 V/1206/1%	Yageo/Phycomp	RC1206FR-071M5L
3	R3, R4, R5	Resistor 12k/200 V/1206/1%	Vishay	CRCW120612K0FK
1	R6	Resistor NA/200 V/1206/1%	Panasonic	ERJ8RQF1R0V
3	R6A, R6B, R6C	Resistor 1.0/200 V/1206/1%	Panasonic	ERJ8RQF1R0V
2	R7, R9	Resistor 22k/150 V/0805/1%	Vishay	CRCW080522K0FK
2	R8, R13	Resistor 0 R/150 V/0805/	Vishay/Multicomp	CRCW08050000Z0, MCMR08X000 PTL
1	R10	Resistor 1.0k/150 V/0805/1%	Bourns	CR0805-FX-1001ELF
2	R11, R11A	Resistor 22 R/150 V/0805/1%	Vishay	CRCW080522R0FK
3	R12, R35, R36	Resistor 47k/150 V/0805/1%	Vishay	CRCW080547K0FKEA
2	R15, R16	Resistor 470k/150 V/0805/1%	Vishay	CRCW0805470KFK
1	R17	Resistor 43k/150 V/0805/1%	Vishay	CRCW080543K0FK
1	R21	Resistor 24.9k/150 V/0805/1%	Vishay	CRCW080524K9FK
1	R23	Resistor 2.2 R/200 V/1206/1%	Vishay	CRCW12062R20FK
1	R24	Resistor 0 R/75 V/0603/0R	Vishay	CRCW06030000Z0
1	R25	Resistor 18k/75 V/0603/1%	Vishay	CRCW060318K0FK
1	R27	Resistor 0 R/75 V/0603/1%	Yageo/Phycomp	RC0603FR-070RL
1	R28	Resistor 22k/75 V/0603/1%	Vishay	CRCW060322K0FK
1	R29	NTC 100k/0805/5%	Epcos	B57471V2104J62
1	R30	Resistor 10 R/150 V/0805/1%	Vishay	CRCW080510R0FKEA
2	R31, R32	Resistor 22 R/150 V/0805/1%	Vishay	CRCW080522R0FKEA
1	R33	Resistor 220 R/150 V/0805/1%	Vishay	CRCW0805220R0FK
3	R34, R34A, R34B	Resistor 1.2 R/200 V/1206/1%	Vishay	CRCW12061R20FK
1	R37	Resistor 330 R/150 V/0805/1%	Vishay	CRCW0805330R0FK
1	R40	Resistor 4.7 R/200 V/1206/1%	Vishay	CRCW12064R70FK
3	R43, R46, R56	Resistor 2.2 M/200 V/1206/1%	Vishay	CRCW12062M20FKEA



# 100 W PFC + LCC LED driver design based on ICL5102

## 1 percent dimming with a compact LCC transformer operating with 180~450 kHz



### Bill of materials

3	R50, R51, R52	Resistor 0.10 R/675 mV/1206/1%	Bourns	CRL1206-FW-R100ELF
1	R57	Resistor 110k/75 V/0603/1%	Vishay	CRCW0603110KFK
1	R59	Resistor 6.2k/75 V/0603/1%	Vishay	CRCW06036K20FK
1	R61	Resistor 10 R/200 V/1206/1%	Vishay	CRCW120610R0FK
4	R62, R63, R65, R67	Resistor 3.3 MEG/200 V/1206/1%	Vishay	CRCW12063M30FK
1	R66	Resistor 180k/200 V/1206/1%	Vishay	CRCW1206180KFK
1	R68	Resistor 2.2k/75 V/0603/1%	Vishay	CRCW06032K20FK
1	R80	Resistor 100 R/150 V/0805/1%	Vishay	CRCW0805100RFK
1	R81	Resistor 360k/150 V/0805/1%	Vishay	CRCW0805360KFK
1	R82	Resistor 33k/150 V/0805/1%	Vishay	CRCW080533K0FK
1	R83	Resistor 2.7k/150 V/0805/1%	Vishay	CRCW08052K70FK
1	R84	Resistor 3.3k/150 V/0805/1%	Vishay	CRCW08053K30FK
1	R85	Resistor 68k/150 V/0805/1%	Vishay	CRCW080568K0FK
1	R87	Resistor 3.9 MEG/150 V/0805/1%	Vishay	CRCW08053M90FK
1	R88	Resistor 330k/150 V/0805/1%	Vishay	CRCW0805330KFK
1	R89	Resistor 8.2k/150 V/0805/1%	Vishay	CRCW08058K20FK
1	R90	Resistor 20k/150 V/0805/1%	Vishay	CRCW080520K0FK
1	R94	Resistor 0 R/200 V/1206/0R	Vishay	CRCW12060000Z0
1	Rf80	Resistor 2k/150 V/0805/1%	Vishay	CRCW08052K00FK
1	Rvs80	Resistor 4.7k/150 V/0805/1%	Vishay	CRCW08054K70FK
1	Rvsh80	Resistor 110k/150 V/0805/1%	Vishay	CRCW0805110KFK
16	TP1, TP2, TP10, TP12, TP14, TP15, TP17, TP18, TP20, TP23, TP24, TP25, TP26, TP27, TP28, TP29	Connector 5000/CON-THT-TP-5000	Keystone Electronics Corp.	5000
1	TR1	Transformer NP2020-14605/THT	ICT	NP2020-14605
1	U80	Ana LM358ADR/SOIC-8 (D)	Texas Instruments	LM358ADR
1	U81	Int TL431CDBZR/SOT-23-3	Texas Instruments	TL431CDBZR
1	VR1	10D561K/560 V/ VARRR750W80L1300T500H1600B/10%	Bourns	MOV-10D561K
1	X1	Connector 1711042/THT	Phoenix Contact	1711042
1	X60	WAGO_250-203/WAGO_250-203	WAGO	250-203
1	X80	Connector 1711026/THT	Phoenix Contact	1711026

**100 W PFC + LCC LED driver design based on ICL5102**  
**1 percent dimming with a compact LCC transformer operating with 180~450 kHz**



**Revision history**

**Revision history**

<b>Document version</b>	<b>Date of release</b>	<b>Description of changes</b>
V 1.0	2021-08-30	First release

#### Trademarks

All referenced product or service names and trademarks are the property of their respective owners.

**Edition 2021-08-30**

**Published by**

**Infineon Technologies AG**

**81726 Munich, Germany**

**© 2021 Infineon Technologies AG.**

**All Rights Reserved.**

**Do you have a question about this document?**

**Email:** [erratum@infineon.com](mailto:erratum@infineon.com)

**Document reference**

**ER\_2104\_PL39\_2104\_122715**

#### IMPORTANT NOTICE

The information contained in this application note is given as a hint for the implementation of the product only and shall in no event be regarded as a description or warranty of a certain functionality, condition or quality of the product. Before implementation of the product, the recipient of this application note must verify any function and other technical information given herein in the real application. Infineon Technologies hereby disclaims any and all warranties and liabilities of any kind (including without limitation warranties of non-infringement of intellectual property rights of any third party) with respect to any and all information given in this application note.

The data contained in this document is exclusively intended for technically trained staff. It is the responsibility of customer's technical departments to evaluate the suitability of the product for the intended application and the completeness of the product information given in this document with respect to such application.

For further information on the product, technology, delivery terms and conditions and prices please contact your nearest Infineon Technologies office ([www.infineon.com](http://www.infineon.com)).

#### WARNINGS

Due to technical requirements products may contain dangerous substances. For information on the types in question please contact your nearest Infineon Technologies office.

Except as otherwise explicitly approved by Infineon Technologies in a written document signed by authorized representatives of Infineon Technologies, Infineon Technologies' products may not be used in any applications where a failure of the product or any consequences of the use thereof can reasonably be expected to result in personal injury.

单击下面可查看定价，库存，交付和生命周期等信息

[>>Infineon\(英飞凌\)](#)