

**INSULATED GATE BIPOLAR TRANSISTOR WITH
ULTRAFAST SOFT RECOVERY DIODE**

**IRGP4069DPbF
IRGP4069D-EPbF**

Features

- Low $V_{CE(ON)}$ Trench IGBT Technology
- Low Switching Losses
- Maximum Junction Temperature 175 °C
- 5 μ S short circuit SOA
- Square RBSOA
- 100% of The Parts Tested for I_{LM}
- Positive $V_{CE(ON)}$ Temperature Coefficient
- Tight Parameter Distribution
- Lead Free Package

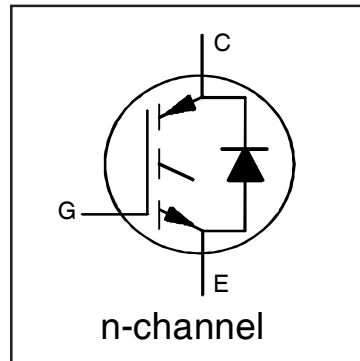

$V_{CES} = 600V$
$I_{C(Nominal)} = 35A$
$t_{SC} \geq 5\mu s, T_{J(max)} = 175^{\circ}C$
$V_{CE(on)} \text{ typ.} = 1.6V$

Benefits

- High Efficiency in a Wide Range of Applications
- Suitable for a Wide Range of Switching Frequencies due to Low $V_{CE(ON)}$ and Low Switching Losses
- Rugged Transient Performance for Increased Reliability
- Excellent Current Sharing in Parallel Operation

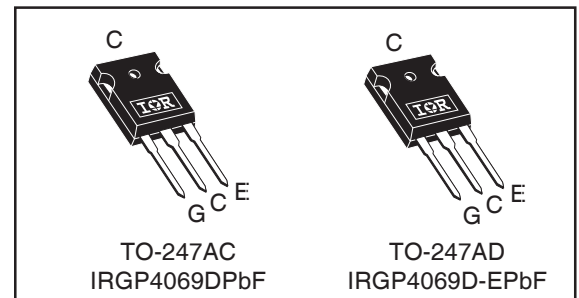

G	C	E
Gate	Collector	Emitter

Absolute Maximum Ratings

	Parameter	Max.	Units
V_{CES}	Collector-to-Emitter Voltage	600	V
$I_C @ T_C = 25^{\circ}C$	Continuous Collector Current	76	A
$I_C @ T_C = 100^{\circ}C$	Continuous Collector Current	50	
$I_{NOMINAL}$	Nominal Current	35	
I_{CM}	Pulse Collector Current, $V_{GE} = 15V$	105	
I_{LM}	Clamped Inductive Load Current, $V_{GE} = 20V$ ①	140	
$I_F @ T_C = 25^{\circ}C$	Diode Continuous Forward Current	76	
$I_F @ T_C = 100^{\circ}C$	Diode Continuous Forward Current	50	
I_{FM}	Diode Maximum Forward Current ②	140	
V_{GE}	Continuous Gate-to-Emitter Voltage	± 20	V
	Transient Gate-to-Emitter Voltage	± 30	
$P_D @ T_C = 25^{\circ}C$	Maximum Power Dissipation	268	W
		$P_D @ T_C = 100^{\circ}C$	
T_J T_{STG}	Operating Junction and Storage Temperature Range	-55 to +175	$^{\circ}C$
		Soldering Temperature, for 10 sec.	
	Mounting Torque, 6-32 or M3 Screw	10 lbf-in (1.1 N·m)	

Thermal Resistance

	Parameter	Min.	Typ.	Max.	Units
$R_{\theta JC}$ (IGBT)	Thermal Resistance Junction-to-Case-(each IGBT) ④	—	—	0.56	$^{\circ}C/W$
$R_{\theta JC}$ (Diode)	Thermal Resistance Junction-to-Case-(each Diode) ④	—	—	1.0	
$R_{\theta CS}$	Thermal Resistance, Case-to-Sink (flat, greased surface)	—	0.24	—	
$R_{\theta JA}$	Thermal Resistance, Junction-to-Ambient (typical socket mount)	—	—	40	

Electrical Characteristics @ T_J = 25°C (unless otherwise specified)

	Parameter	Min.	Typ.	Max.	Units	Conditions
V _{(BR)CES}	Collector-to-Emitter Breakdown Voltage	600	—	—	V	V _{GE} = 0V, I _C = 100μA ③
ΔV _{(BR)CES} /ΔT _J	Temperature Coeff. of Breakdown Voltage	—	1.3	—	mV/°C	V _{GE} = 0V, I _C = 1mA (25°C-175°C)
V _{CE(on)}	Collector-to-Emitter Saturation Voltage	—	1.6	1.85	V	I _C = 35A, V _{GE} = 15V, T _J = 25°C ②
		—	1.9	—		I _C = 35A, V _{GE} = 15V, T _J = 150°C ②
		—	2.0	—		I _C = 35A, V _{GE} = 15V, T _J = 175°C ②
V _{GE(th)}	Gate Threshold Voltage	4.0	—	6.5	V	V _{CE} = V _{GE} , I _C = 1.0mA
ΔV _{GE(th)} /ΔT _J	Threshold Voltage temp. coefficient	—	-18	—	mV/°C	V _{CE} = V _{GE} , I _C = 1.0mA (25°C - 175°C)
g _{fe}	Forward Transconductance	—	25	—	S	V _{CE} = 50V, I _C = 35A, PW = 60μs
I _{CES}	Collector-to-Emitter Leakage Current	—	1.0	70	μA	V _{GE} = 0V, V _{CE} = 600V
		—	770	—		V _{GE} = 0V, V _{CE} = 600V, T _J = 175°C
V _{FM}	Diode Forward Voltage Drop	—	2.2	3.8	V	I _F = 35A
		—	1.4	—		I _F = 35A, T _J = 175°C
I _{GES}	Gate-to-Emitter Leakage Current	—	—	±100	nA	V _{GE} = ±20V

Switching Characteristics @ T_J = 25°C (unless otherwise specified)

	Parameter	Min.	Typ.	Max.	Units	Conditions
Q _g	Total Gate Charge (turn-on)	—	69	104	nC	I _C = 35A V _{GE} = 15V V _{CC} = 400V
Q _{ge}	Gate-to-Emitter Charge (turn-on)	—	18	27		
Q _{gc}	Gate-to-Collector Charge (turn-on)	—	29	44		
E _{on}	Turn-On Switching Loss	—	390	508	μJ	I _C = 35A, V _{CC} = 400V, V _{GE} = 15V R _G = 10Ω, L = 200μH, L _S = 150nH, T _J = 25°C Energy losses include tail & diode reverse recovery
E _{off}	Turn-Off Switching Loss	—	632	753		
E _{total}	Total Switching Loss	—	1022	1261		
t _{d(on)}	Turn-On delay time	—	46	56	ns	I _C = 35A, V _{CC} = 400V, V _{GE} = 15V R _G = 10Ω, L = 200μH, L _S = 150nH, T _J = 25°C
t _r	Rise time	—	33	42		
t _{d(off)}	Turn-Off delay time	—	105	117		
t _f	Fall time	—	44	54		
E _{on}	Turn-On Switching Loss	—	1013	—		
E _{off}	Turn-Off Switching Loss	—	929	—		
E _{total}	Total Switching Loss	—	1942	—		
t _{d(on)}	Turn-On delay time	—	43	—	ns	I _C = 35A, V _{CC} = 400V, V _{GE} = 15V R _G = 10Ω, L = 200μH, L _S = 150nH T _J = 175°C
t _r	Rise time	—	35	—		
t _{d(off)}	Turn-Off delay time	—	127	—		
t _f	Fall time	—	61	—		
C _{ies}	Input Capacitance	—	2113	—	pF	V _{GE} = 0V V _{CC} = 30V f = 1.0Mhz
C _{oes}	Output Capacitance	—	197	—		
C _{res}	Reverse Transfer Capacitance	—	65	—		
RBSOA	Reverse Bias Safe Operating Area	FULL SQUARE				T _J = 175°C, I _C = 140A V _{CC} = 480V, V _p = 600V R _G = 10Ω, V _{GE} = +20V to 0V
SCSOA	Short Circuit Safe Operating Area	5	—	—	μs	V _{CC} = 400V, V _p = 600V R _G = 10Ω, V _{GE} = +15V to 0V
E _{rec}	Reverse Recovery Energy of the Diode	—	304	—	μJ	T _J = 175°C
t _{rr}	Diode Reverse Recovery Time	—	120	—	ns	V _{CC} = 400V, I _F = 35A
I _{rr}	Peak Reverse Recovery Current	—	25	—	A	V _{GE} = 15V, R _G = 10Ω, L = 210μH, L _S = 150nH

Notes:

- ① V_{CC} = 80% (V_{CES}), V_{GE} = 20V, L = 19μH, R_G = 10Ω.
- ② Pulse width limited by max. junction temperature.
- ③ Refer to AN-1086 for guidelines for measuring V_{(BR)CES} safely.
- ④ R_θ is measured at T_J of approximately 90°C.

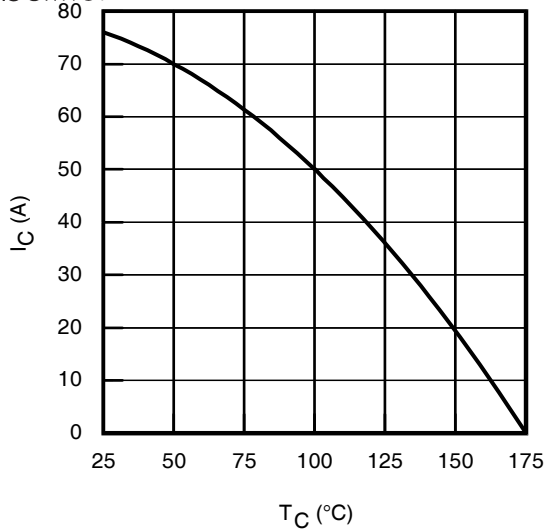

Fig. 1 - Maximum DC Collector Current vs. Case Temperature

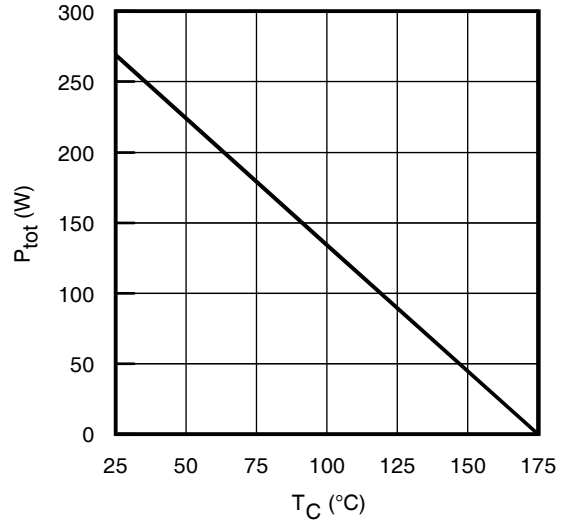

Fig. 2 - Power Dissipation vs. Case Temperature

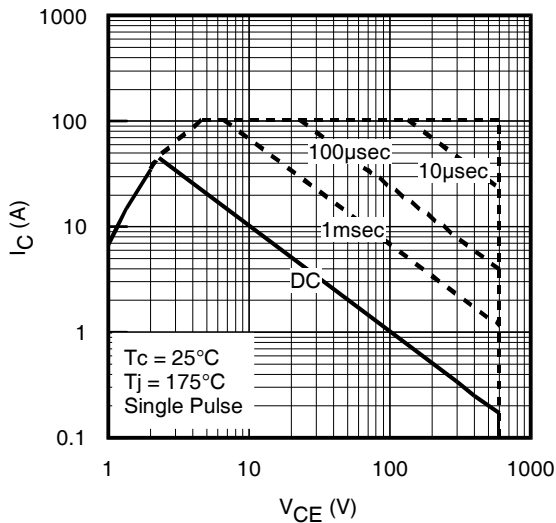

Fig. 3 - Forward SOA
 $T_C = 25^{\circ}C$, $T_J \leq 175^{\circ}C$; $V_{GE} = 15V$



Fig. 4 - Reverse Bias SOA
 $T_J = 175^{\circ}C$; $V_{GE} = 20V$

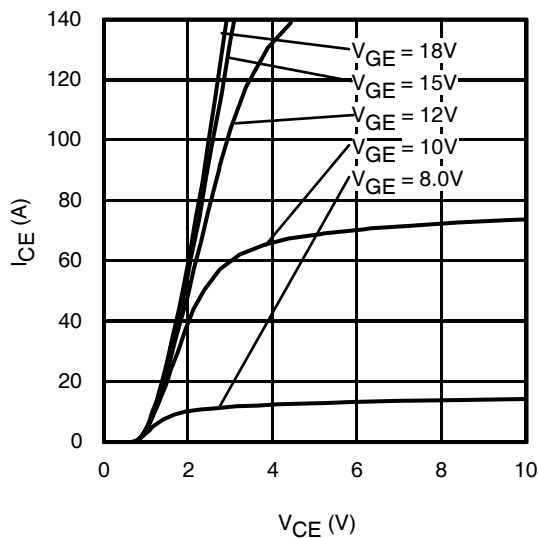

Fig. 5 - Typ. IGBT Output Characteristics
 $T_J = -40^{\circ}C$; $t_p \leq 60\mu s$



Fig. 6 - Typ. IGBT Output Characteristics
 $T_J = 25^{\circ}C$; $t_p \leq 60\mu s$

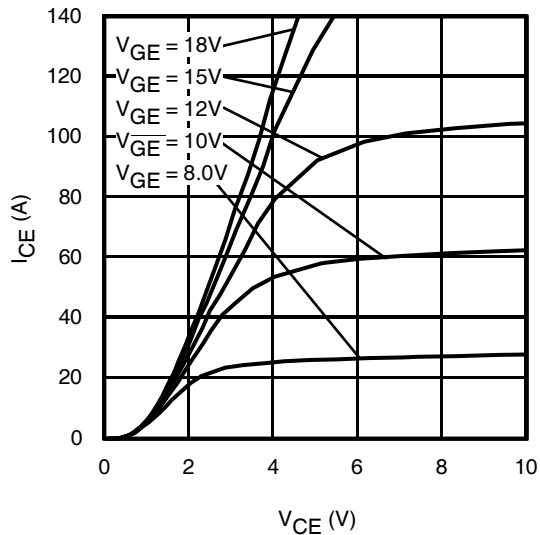

Fig. 7 - Typ. IGBT Output Characteristics
 $T_J = 175^\circ\text{C}$; $t_p \leq 60\mu\text{s}$

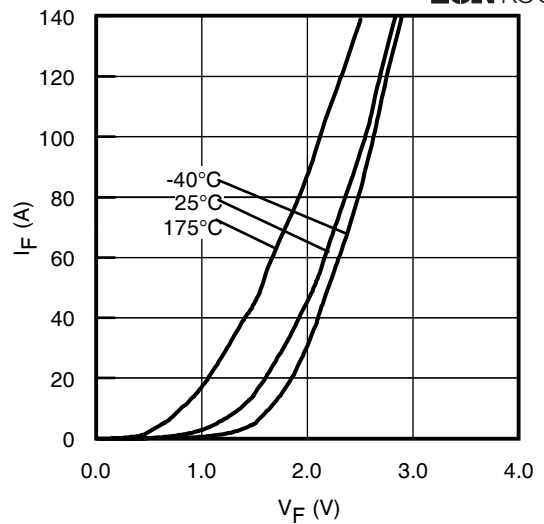

Fig. 8 - Typ. Diode Forward Characteristics
 $t_p = 80\mu\text{s}$

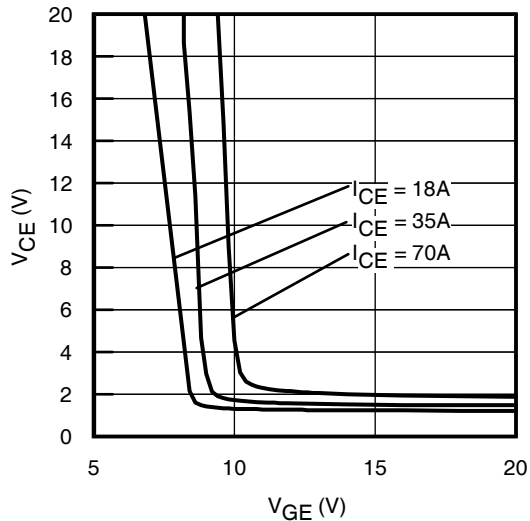

Fig. 9 - Typical V_{CE} vs. V_{GE}
 $T_J = -40^\circ\text{C}$

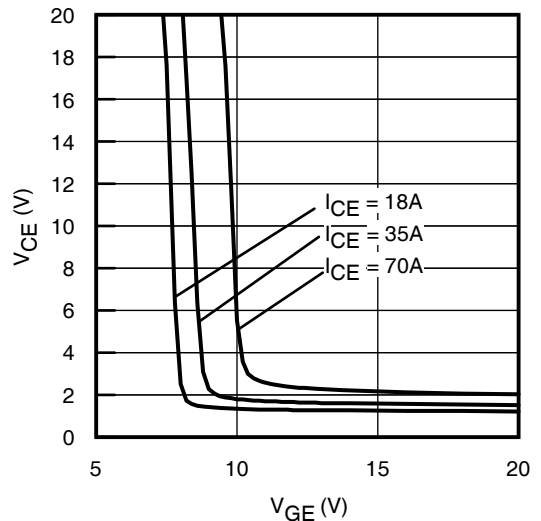

Fig. 10 - Typical V_{CE} vs. V_{GE}
 $T_J = 25^\circ\text{C}$



Fig. 11 - Typical V_{CE} vs. V_{GE}
 $T_J = 175^\circ\text{C}$

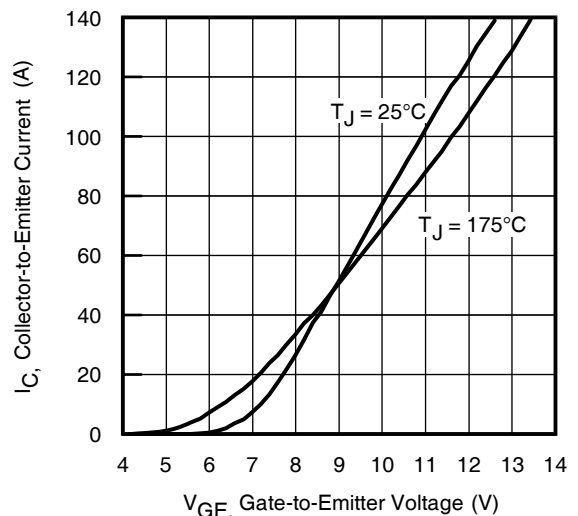

Fig. 12 - Typ. Transfer Characteristics
 $V_{CE} = 50\text{V}$; $t_p = 60\mu\text{s}$

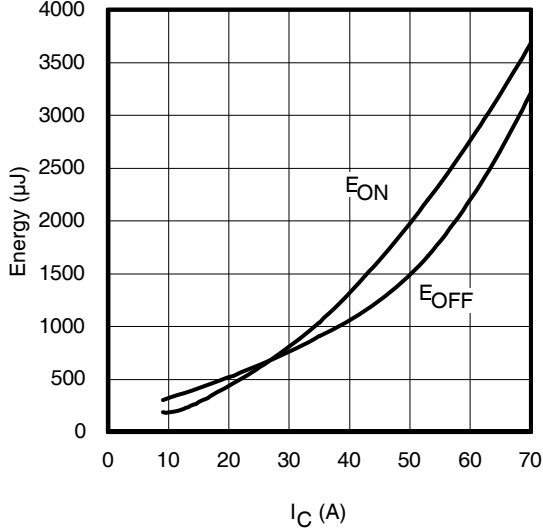

Fig. 13 - Typ. Energy Loss vs. I_C

$T_J = 175^\circ\text{C}$; $L = 200\mu\text{H}$; $V_{CE} = 400\text{V}$, $R_G = 10\Omega$; $V_{GE} = 15\text{V}$

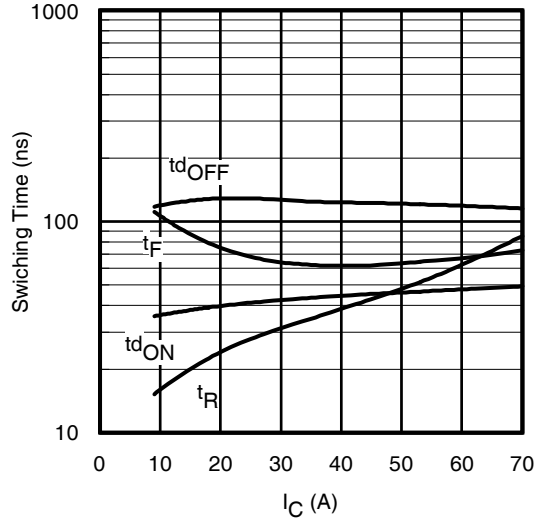

Fig. 14 - Typ. Switching Time vs. I_C

$T_J = 175^\circ\text{C}$; $L = 200\mu\text{H}$; $V_{CE} = 400\text{V}$, $R_G = 10\Omega$; $V_{GE} = 15\text{V}$

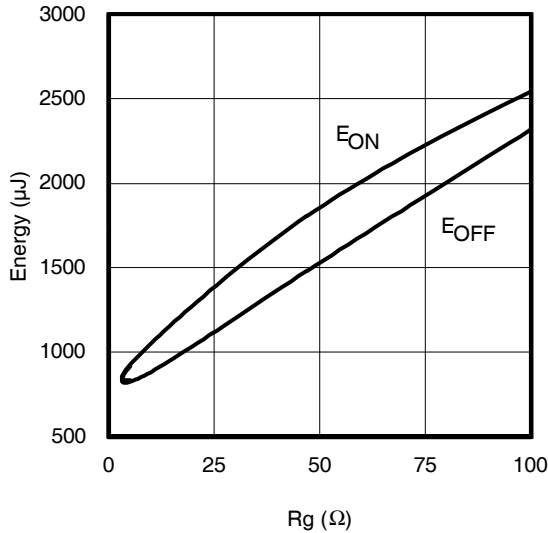

Fig. 15 - Typ. Energy Loss vs. R_G

$T_J = 175^\circ\text{C}$; $L = 210\mu\text{H}$; $V_{CE} = 400\text{V}$, $I_{CE} = 35\text{A}$; $V_{GE} = 15\text{V}$

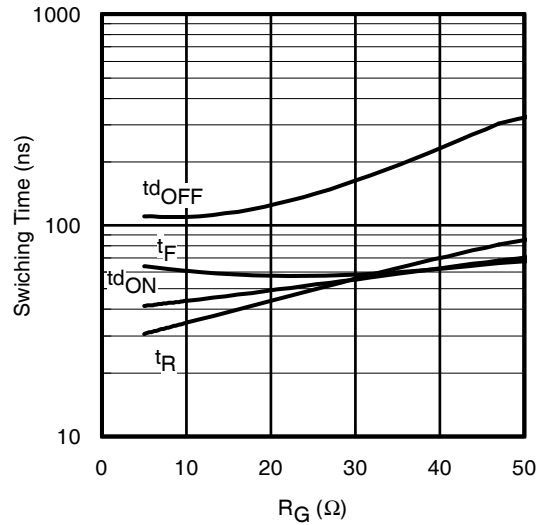

Fig. 16 - Typ. Switching Time vs. R_G

$T_J = 175^\circ\text{C}$; $L = 210\mu\text{H}$; $V_{CE} = 400\text{V}$, $I_{CE} = 35\text{A}$; $V_{GE} = 15\text{V}$

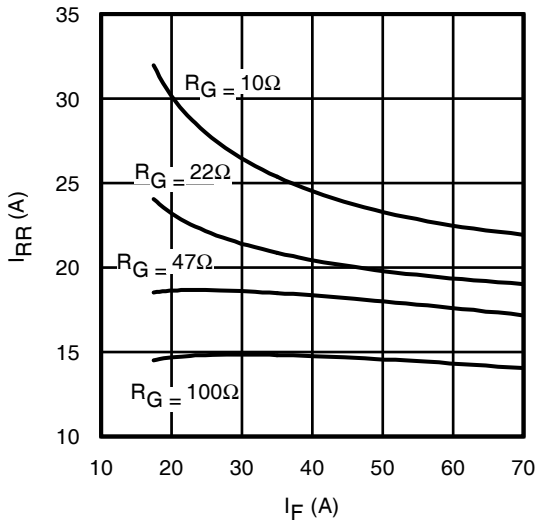

Fig. 17 - Typ. Diode I_{RR} vs. I_F

$T_J = 175^\circ\text{C}$

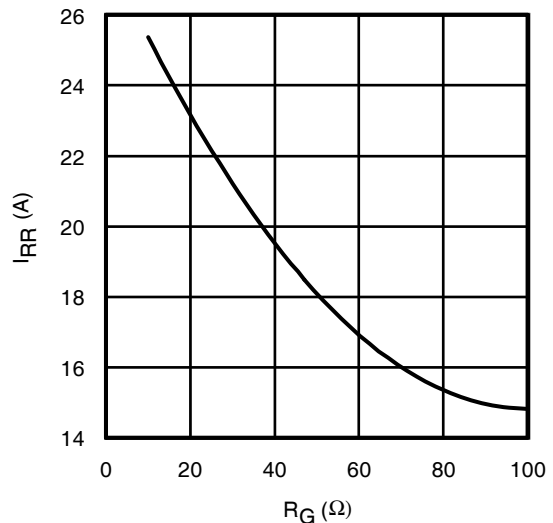

Fig. 18 - Typ. Diode I_{RR} vs. R_G

$T_J = 175^\circ\text{C}$

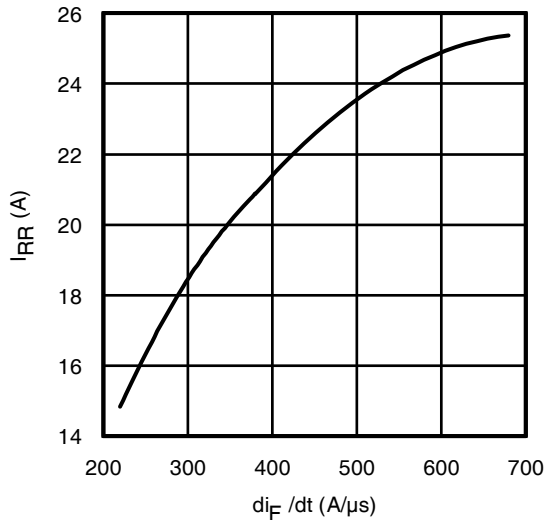

Fig. 19 - Typ. Diode I_{RR} vs. di_F/dt
 $V_{CC} = 400V$; $V_{GE} = 15V$; $I_F = 35A$; $T_J = 175^\circ C$

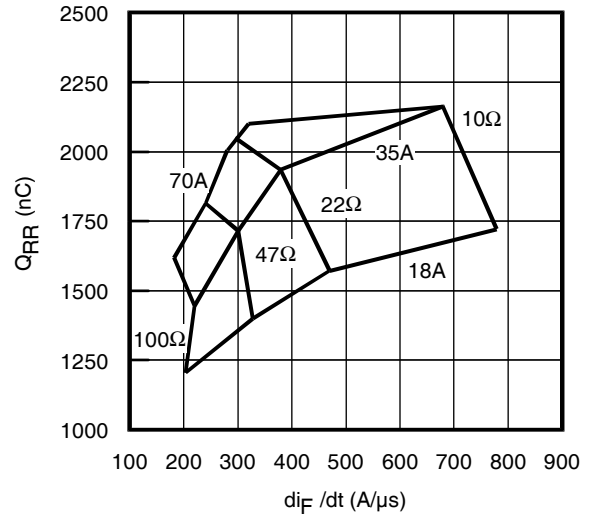

Fig. 20 - Typ. Diode Q_{RR} vs. di_F/dt
 $V_{CC} = 400V$; $V_{GE} = 15V$; $T_J = 175^\circ C$

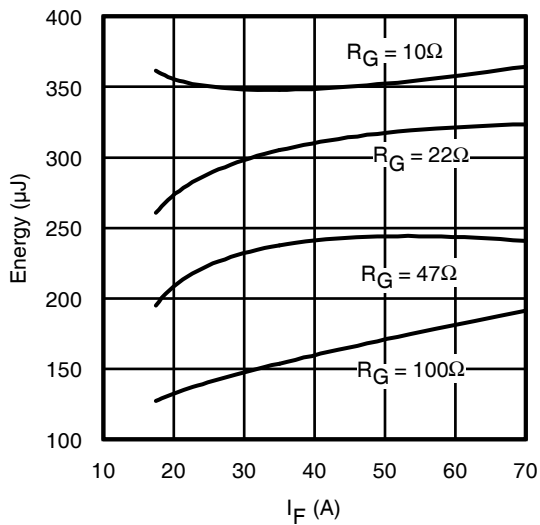

Fig. 21 - Typ. Diode E_{RR} vs. I_F
 $T_J = 175^\circ C$

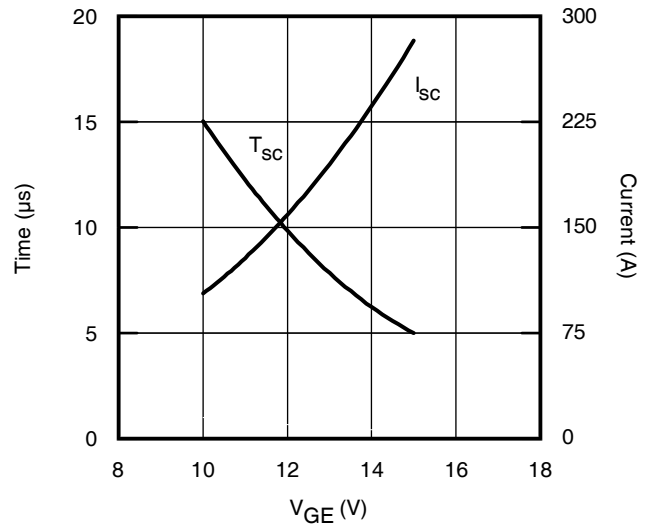

Fig. 22 - V_{GE} vs. Short Circuit Time
 $V_{CC} = 400V$; $T_C = 25^\circ C$

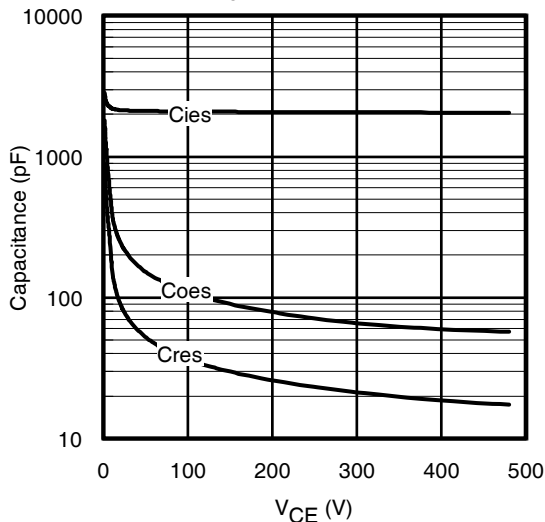

Fig. 23 - Typ. Capacitance vs. V_{CE}
 $V_{GE} = 0V$; $f = 1MHz$

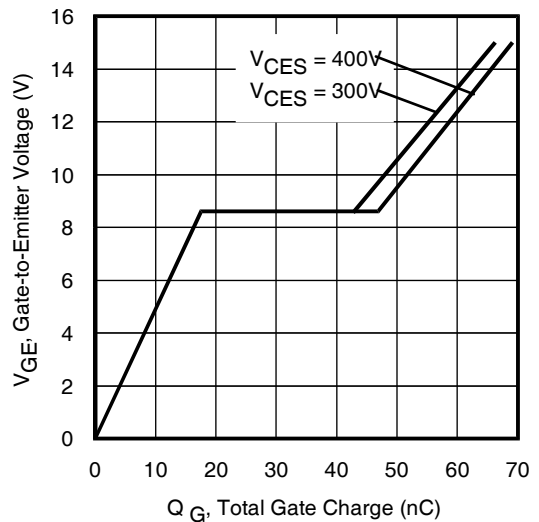

Fig. 24 - Typical Gate Charge vs. V_{GE}
 $I_{CE} = 35A$; $L = 740\mu H$

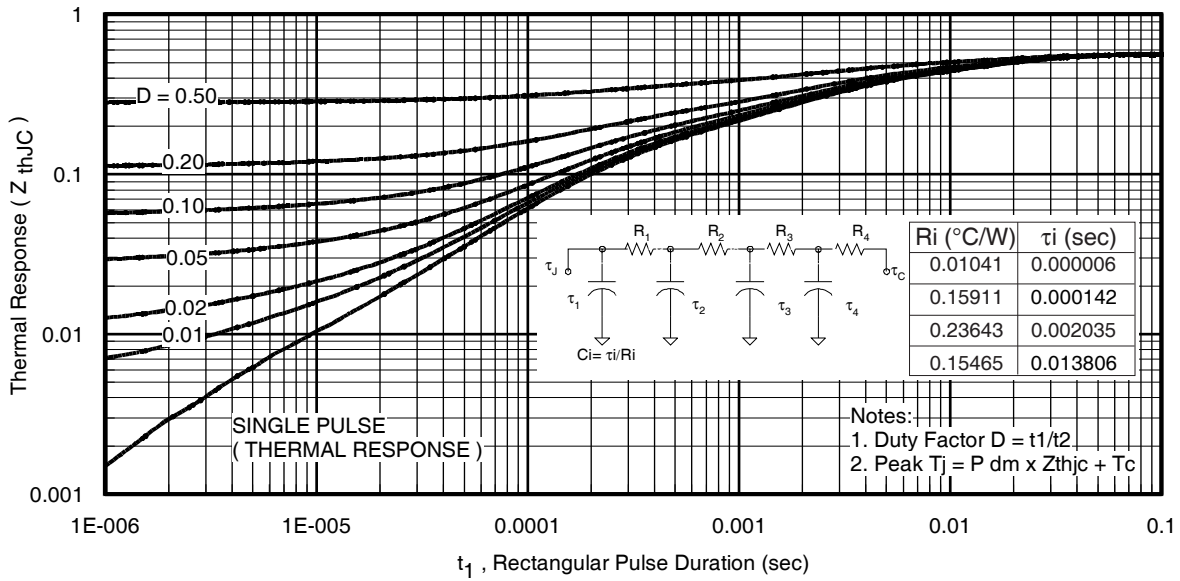

Fig 25. Maximum Transient Thermal Impedance, Junction-to-Case (IGBT)

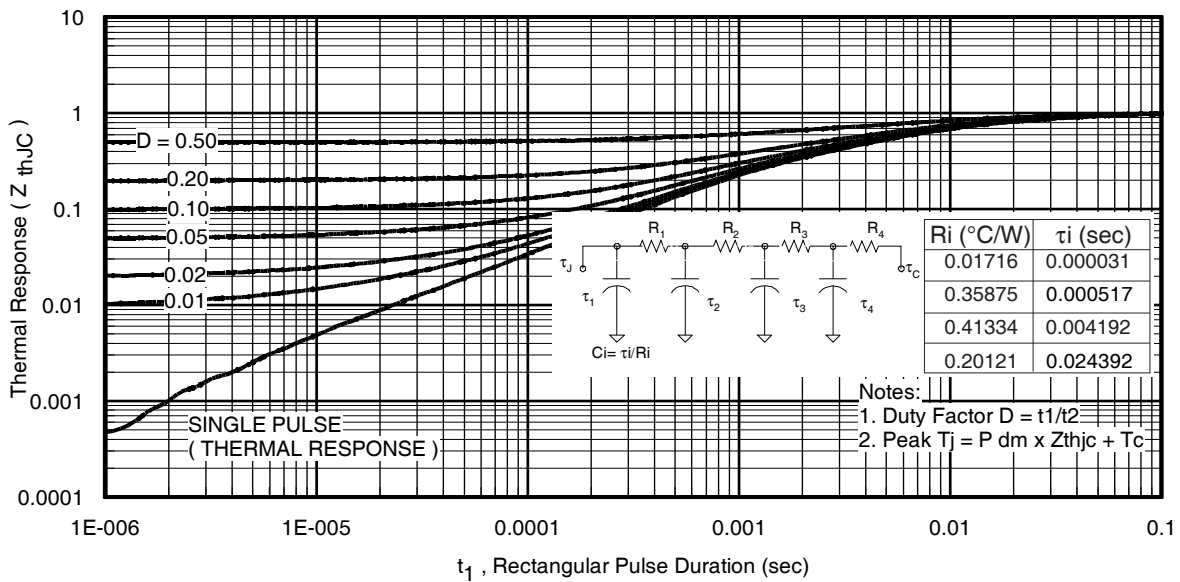

Fig. 26. Maximum Transient Thermal Impedance, Junction-to-Case (DIODE)



Fig.C.T.1 - Gate Charge Circuit (turn-off)

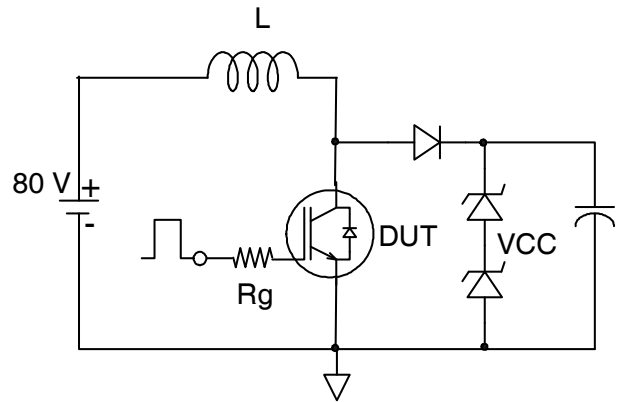

Fig.C.T.2 - RBSOA Circuit



Fig.C.T.3 - S.C. SOA Circuit

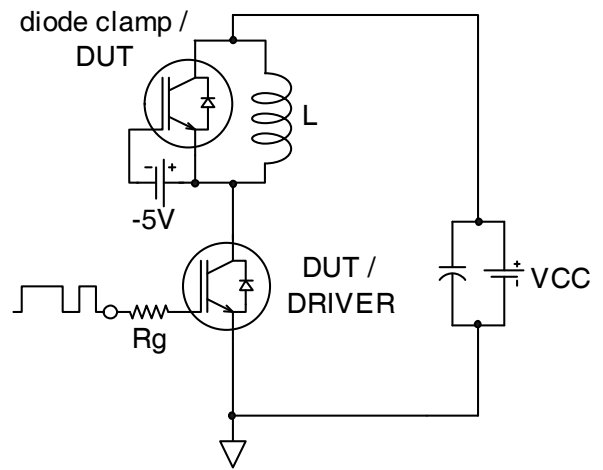

Fig.C.T.4 - Switching Loss Circuit



Fig.C.T.5 - Resistive Load Circuit

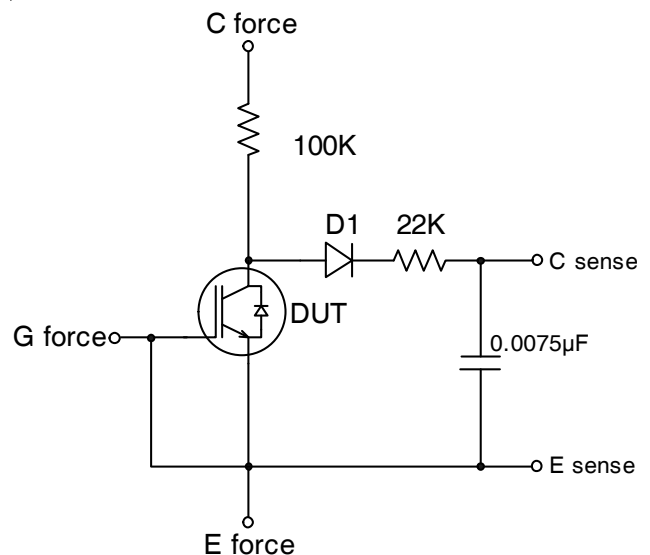

Fig.C.T.6 - BVCES Filter Circuit

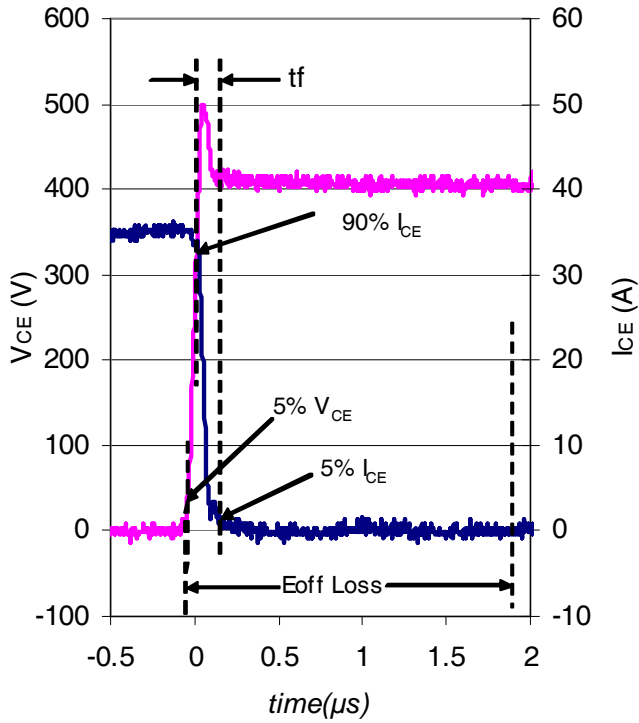

Fig. WF1 - Typ. Turn-off Loss Waveform
@ T_J = 175°C using Fig. CT.4

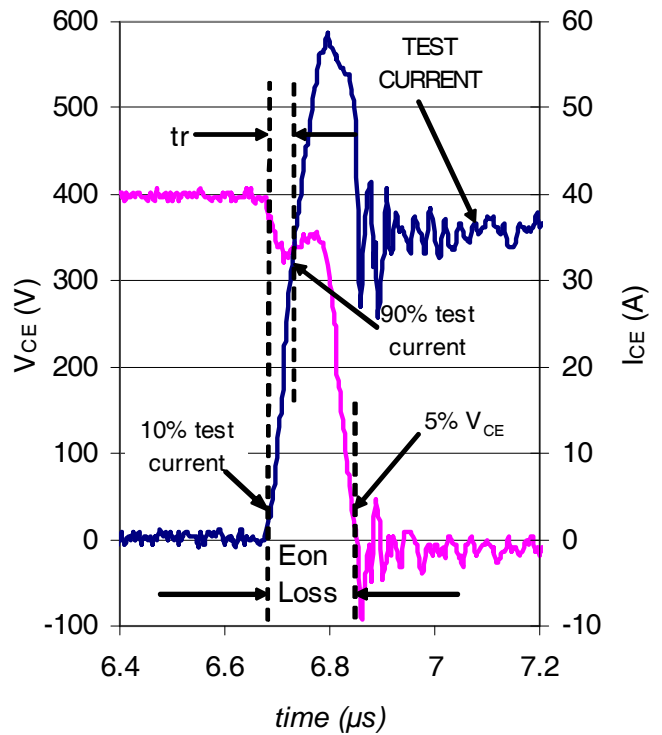

Fig. WF2 - Typ. Turn-on Loss Waveform
@ T_J = 175°C using Fig. CT.4

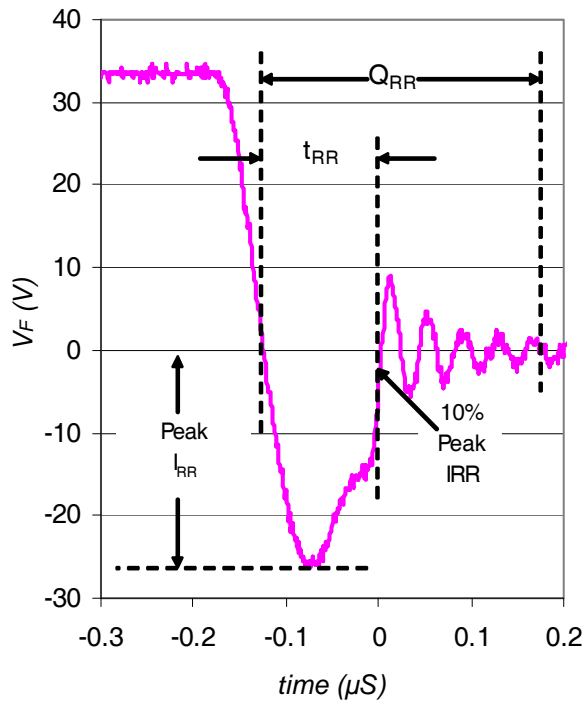

Fig. WF3 - Typ. Diode Recovery Waveform
@ T_J = 175°C using Fig. CT.4

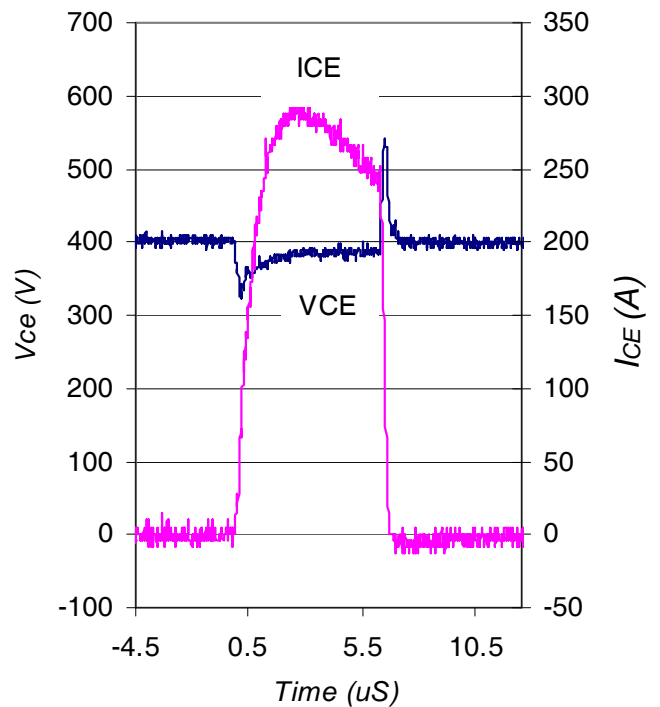

Fig. WF4 - Typ. S.C. Waveform
@ T_J = 25°C using Fig. CT.3

IRGP4069DPbF/IRGP4069D-EPbF

TO-247AC Package Outline

Dimensions are shown in millimeters (inches)



NOTES:

1. DIMENSIONING AND TOLERANCING AS PER ASME Y14.5M 1994.
2. DIMENSIONS ARE SHOWN IN INCHES.
3. CONTOUR OF SLOT OPTIONAL.
4. DIMENSION D & E DO NOT INCLUDE MOLD FLASH. MOLD FLASH SHALL NOT EXCEED .005" (0.127) PER SIDE. THESE DIMENSIONS ARE MEASURED AT THE OUTERMOST EXTREMES OF THE PLASTIC BODY.
5. THERMAL PAD CONTOUR OPTIONAL WITHIN DIMENSIONS D1 & E1.
6. LEAD FINISH UNCONTROLLED IN L1.
7. ϕP TO HAVE A MAXIMUM DRAFT ANGLE OF 1.5 ° TO THE TOP OF THE PART WITH A MAXIMUM HOLE DIAMETER OF .154 INCH.
8. OUTLINE CONFORMS TO JEDEC OUTLINE TO-247AC .

SYMBOL	DIMENSIONS				NOTES
	INCHES		MILLIMETERS		
	MIN.	MAX.	MIN.	MAX.	
A	.183	.209	4.65	5.31	
A1	.087	.102	2.21	2.59	
A2	.059	.098	1.50	2.49	
b	.039	.055	0.99	1.40	
b1	.039	.053	0.99	1.35	
b2	.065	.094	1.65	2.39	
b3	.065	.092	1.65	2.34	
b4	.102	.135	2.59	3.43	
b5	.102	.133	2.59	3.38	
c	.015	.035	0.38	0.89	
c1	.015	.033	0.38	0.84	
D	.776	.815	19.71	20.70	4
D1	.515	-	13.08	-	5
D2	.020	.053	0.51	1.35	
E	.602	.625	15.29	15.87	4
E1	.530	-	13.46	-	
E2	.178	.216	4.52	5.49	
e	.215 BSC		5.46 BSC		
ϕk	.010		0.25		
L	.559	.634	14.20	16.10	
L1	.146	.169	3.71	4.29	
ϕP	.140	.144	3.56	3.66	
$\phi P1$	-	.291	-	7.39	
Q	.209	.224	5.31	5.69	
S	.217 BSC		5.51 BSC		

LEAD ASSIGNMENTS

HEXFET

- 1.- GATE
- 2.- DRAIN
- 3.- SOURCE
- 4.- DRAIN

IGBTs, CoPACK

- 1.- GATE
- 2.- COLLECTOR
- 3.- EMITTER
- 4.- COLLECTOR

DIODES

- 1.- ANODE/OPEN
- 2.- CATHODE
- 3.- ANODE

TO-247AC Part Marking Information

EXAMPLE: THIS IS AN IRFPE30
WITH ASSEMBLY
LOT CODE 5657
ASSEMBLED ON WW 35, 2001
IN THE ASSEMBLY LINE "H"

Note: "P" in assembly line position
indicates "Lead-Free"

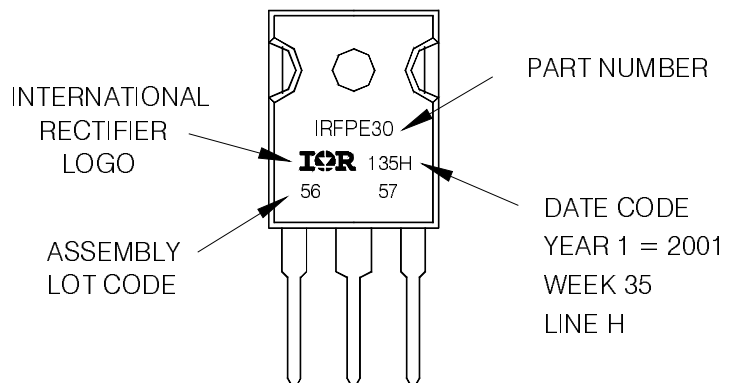

TO-247AC package is not recommended for Surface Mount Application.

Note: For the most current drawing please refer to IR website at <http://www.irf.com/package/>

TO-247AD Package Outline

Dimensions are shown in millimeters (inches)

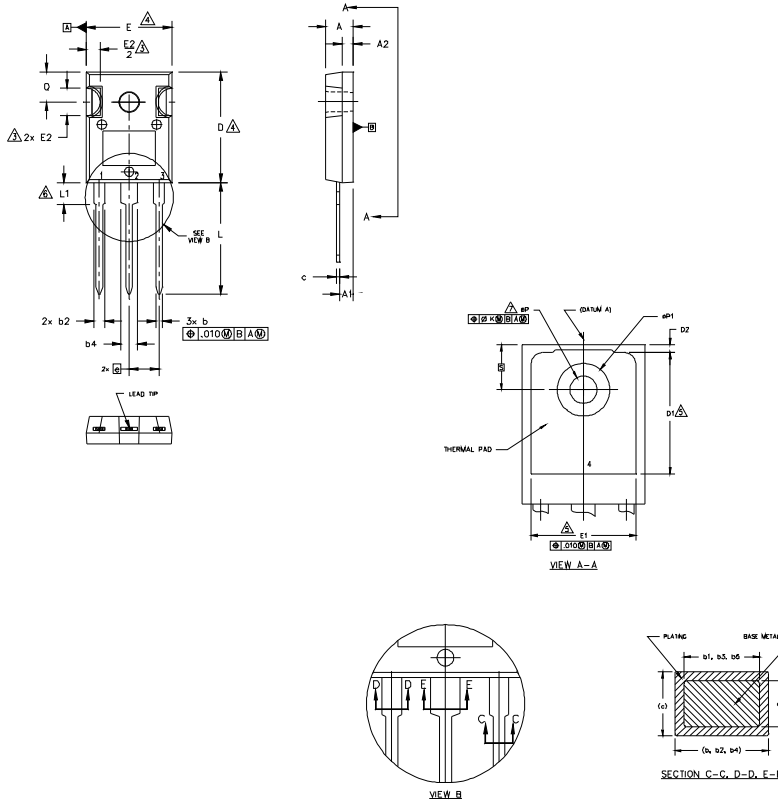

NOTES:

1. DIMENSIONING AND TOLERANCING AS PER ASME Y14.5M 1994.
2. DIMENSIONS ARE SHOWN IN INCHES.
3. CONTOUR OF SLOT OPTIONAL.
4. DIMENSION D & E DO NOT INCLUDE MOLD FLASH. MOLD FLASH SHALL NOT EXCEED .005" (0.127) PER SIDE. THESE DIMENSIONS ARE MEASURED AT THE OUTERMOST EXTREMES OF THE PLASTIC BODY.
5. THERMAL PAD CONTOUR OPTIONAL WITHIN DIMENSIONS D1 & E1.
6. LEAD FINISH UNCONTROLLED IN L1.
7. ϕP TO HAVE A MAXIMUM DRAFT ANGLE OF 1.5 ° TO THE TOP OF THE PART WITH A MAXIMUM HOLE DIAMETER OF .154 INCH.
8. OUTLINE CONFORMS TO JEDEC OUTLINE TO-247AD.

SYMBOL	DIMENSIONS				NOTES
	INCHES		MILLIMETERS		
	MIN.	MAX.	MIN.	MAX.	
A	.183	.209	4.65	5.31	
A1	.087	.102	2.21	2.59	
A2	.059	.098	1.50	2.49	
b	.039	.055	0.99	1.40	
b1	.039	.053	0.99	1.35	
b2	.065	.094	1.65	2.39	
b3	.065	.092	1.65	2.34	
b4	.102	.135	2.59	3.43	
b5	.102	.133	2.59	3.38	
c	.015	.035	0.38	0.89	
c1	.015	.033	0.38	0.84	
D	.776	.815	19.71	20.70	4
D1	.515	-	13.08	-	5
D2	.020	.053	0.51	1.35	
E	.602	.625	15.29	15.87	4
E1	.530	-	13.46	-	
E2	.178	.216	4.52	5.49	
e	.215 BSC		5.46 BSC		
ϕk	.010		0.25		
L	.780	.827	19.57	21.00	
L1	.146	.169	3.71	4.29	
ϕP	.140	.144	3.56	3.66	
$\phi P1$	-	.291	-	7.39	
Q	.209	.224	5.31	5.69	
S	.217 BSC		5.51 BSC		

LEAD ASSIGNMENTS

- HEXFET**
- 1.- GATE
 - 2.- DRAIN
 - 3.- SOURCE
 - 4.- DRAIN

IGBTs, CoPACK

- 1.- GATE
- 2.- COLLECTOR
- 3.- EMITTER
- 4.- COLLECTOR

DIGIDES

- 1.- ANODE/OPEN
- 2.- CATHODE
- 3.- ANODE

TO-247AD Part Marking Information

EXAMPLE: THIS IS AN IRGP30B120KD-E
WITH ASSEMBLY
LOT CODE 5657
ASSEMBLED ON WW 35, 2000
IN THE ASSEMBLY LINE "H"

Note: "P" in assembly line position
indicates "Lead-Free"

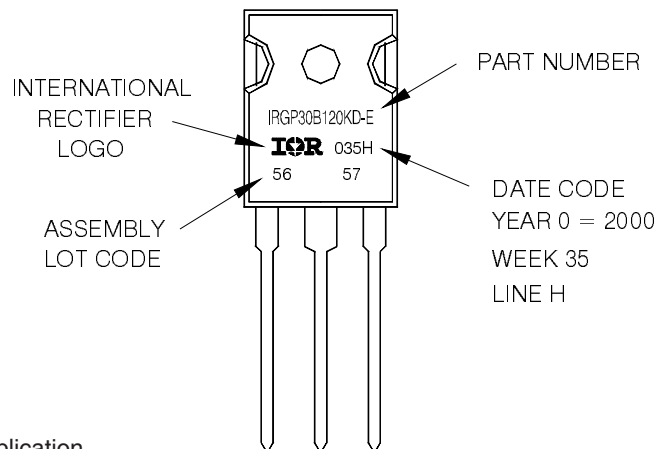

TO-247AD package is not recommended for Surface Mount Application.

Note: For the most current drawing please refer to IR website at <http://www.irf.com/package/>

Data and specifications subject to change without notice.
This product has been designed and qualified for Industrial market.
Qualification Standards can be found on IR's Web site.

单击下面可查看定价，库存，交付和生命周期等信息

[>>Infineon Technologies\(英飞凌\)](#)