

hochisolierendes Modul mit Trench/Feldstopp IGBT3 und Emitter Controlled 3 Diode
 highly insulated module with Trench/Fieldstop IGBT3 and Emitter Controlled 3 diode

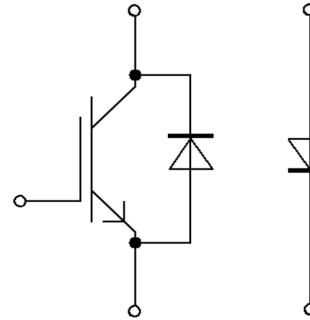

$V_{CES} = 6500V$
 $I_{C\ nom} = 500A / I_{CRM} = 1000A$

Potentielle Anwendungen

- Chopper-Anwendungen
- Mittelspannungsantriebe
- Traktionsumrichter

Potential Applications

- Chopper applications
- Medium voltage converters
- Traction drives

Elektrische Eigenschaften

- Niedriges V_{CEsat}

Electrical Features

- LOW V_{CEsat}

Mechanische Eigenschaften

- AISiC Bodenplatte für erhöhte thermische Lastwechselfestigkeit
- Erweiterter Lagertemperaturbereich bis zu $T_{stg} = -55^{\circ}C$
- Gehäuse mit CTI > 600
- Gehäuse mit erweiterten Isolationseigenschaften von 10,4kV AC 10s
- Große Luft- und Kriechstrecken

Mechanical Features

- AISiC base plate for increased thermal cycling capability
- Extended storage temperature down to $T_{stg} = -55^{\circ}C$
- Package with CTI > 600
- Package with enhanced insulation of 10.4kV AC 10s
- High creepage and clearance distances

Module Label Code

Barcode Code 128



DMX - Code



Content of the Code

| Content of the Code | Digit |
|----------------------------|---------|
| Module Serial Number | 1 - 5 |
| Module Material Number | 6 - 11 |
| Production Order Number | 12 - 19 |
| Datecode (Production Year) | 20 - 21 |
| Datecode (Production Week) | 22 - 23 |

IGBT, Brems-Chopper / IGBT, Brake-Chopper Höchstzulässige Werte / Maximum Rated Values

| | | | | |
|--|---|-----------|----------------------|---|
| Kollektor-Emitter-Sperrspannung Collector-emitter voltage | $T_{vj} = 125^{\circ}\text{C}$ $T_{vj} = 25^{\circ}\text{C}$ $T_{vj} = -50^{\circ}\text{C}$ | V_{CES} | 6500 6500 5900 | V |
| Kollektor-Dauergleichstrom Continuous DC collector current | $T_C = 80^{\circ}\text{C}$, $T_{vj\text{max}} = 150^{\circ}\text{C}$ | I_{CDC} | 500 | A |
| Periodischer Kollektor-Spitzenstrom Repetitive peak collector current | $t_p = 1\text{ ms}$ | I_{CRM} | 1000 | A |
| Gate-Emitter-Spitzenspannung Gate-emitter peak voltage | | V_{GES} | +/-20 | V |

Charakteristische Werte / Characteristic Values

| | | min. | typ. | max. | | | |
|---|---|---|--------------------|--------------|--------------|--------|--------------------------------|
| Kollektor-Emitter-Sättigungsspannung Collector-emitter saturation voltage | $I_C = 500\text{ A}$ $V_{GE} = 15\text{ V}$ | $T_{vj} = 25^{\circ}\text{C}$ $T_{vj} = 125^{\circ}\text{C}$ | $V_{CE\text{sat}}$ | 3,00 3,70 | 3,40 4,20 | V V | |
| Gate-Schwellenspannung Gate threshold voltage | $I_C = 70,0\text{ mA}$, $V_{CE} = V_{GE}$, $T_{vj} = 25^{\circ}\text{C}$ | | V_{GEth} | 5,40 | 6,00 | 6,60 | V |
| Gateladung Gate charge | $V_{GE} = -15 / 15\text{ V}$, $V_{CE} = 3600\text{ V}$ | | Q_G | 20,0 | | | μC |
| Interner Gatewiderstand Internal gate resistor | $T_{vj} = 25^{\circ}\text{C}$ | | R_{Gint} | 1,1 | | | Ω |
| Eingangskapazität Input capacitance | $f = 1000\text{ kHz}$, $T_{vj} = 25^{\circ}\text{C}$, $V_{CE} = 25\text{ V}$, $V_{GE} = 0\text{ V}$ | | C_{ies} | 135 | | | nF |
| Rückwirkungskapazität Reverse transfer capacitance | $f = 1000\text{ kHz}$, $T_{vj} = 25^{\circ}\text{C}$, $V_{CE} = 25\text{ V}$, $V_{GE} = 0\text{ V}$ | | C_{res} | 2,10 | | | nF |
| Kollektor-Emitter-Reststrom Collector-emitter cut-off current | $V_{CE} = 6500\text{ V}$, $V_{GE} = 0\text{ V}$, $T_{vj} = 25^{\circ}\text{C}$ | | I_{CES} | | | 5,0 | mA |
| Gate-Emitter-Reststrom Gate-emitter leakage current | $V_{CE} = 0\text{ V}$, $V_{GE} = 20\text{ V}$, $T_{vj} = 25^{\circ}\text{C}$ | | I_{GES} | | | 400 | nA |
| Einschaltverzögerungszeit, induktive Last Turn-on delay time, inductive load | $I_C = 500\text{ A}$, $V_{CE} = 3600\text{ V}$ $V_{GE} = -15 / 15\text{ V}$ $R_{Gon} = 1,5\ \Omega$ | $T_{vj} = 25^{\circ}\text{C}$ $T_{vj} = 125^{\circ}\text{C}$ | t_{don} | 0,70 0,80 | | | μs μs |
| Anstiegszeit, induktive Last Rise time, inductive load | $I_C = 500\text{ A}$, $V_{CE} = 3600\text{ V}$ $V_{GE} = -15 / 15\text{ V}$ $R_{Gon} = 1,5\ \Omega$ | $T_{vj} = 25^{\circ}\text{C}$ $T_{vj} = 125^{\circ}\text{C}$ | t_r | 0,33 0,40 | | | μs μs |
| Abschaltverzögerungszeit, induktive Last Turn-off delay time, inductive load | $I_C = 500\text{ A}$, $V_{CE} = 3600\text{ V}$ $V_{GE} = -15 / 15\text{ V}$ $R_{Goff} = 10\ \Omega$ | $T_{vj} = 25^{\circ}\text{C}$ $T_{vj} = 125^{\circ}\text{C}$ | t_{doff} | 7,30 7,60 | | | μs μs |
| Fallzeit, induktive Last Fall time, inductive load | $I_C = 500\text{ A}$, $V_{CE} = 3600\text{ V}$ $V_{GE} = -15 / 15\text{ V}$ $R_{Goff} = 10\ \Omega$ | $T_{vj} = 25^{\circ}\text{C}$ $T_{vj} = 125^{\circ}\text{C}$ | t_f | 0,40 0,50 | | | μs μs |
| Einschaltverlustenergie pro Puls Turn-on energy loss per pulse | $I_C = 500\text{ A}$, $V_{CE} = 3600\text{ V}$, $L_{\sigma} = 280\text{ nH}$ $di/dt = 2000\text{ A}/\mu\text{s}$ $V_{GE} = -15 / 15\text{ V}$, $R_{Gon} = 1,5\ \Omega$ | $T_{vj} = 25^{\circ}\text{C}$ $T_{vj} = 125^{\circ}\text{C}$ | E_{on} | 2800 4300 | | | mJ mJ |
| Abschaltverlustenergie pro Puls Turn-off energy loss per pulse | $I_C = 500\text{ A}$, $V_{CE} = 3600\text{ V}$, $L_{\sigma} = 280\text{ nH}$ $V_{GE} = -15 / 15\text{ V}$, $R_{Goff} = 10\ \Omega$ | $T_{vj} = 25^{\circ}\text{C}$ $T_{vj} = 125^{\circ}\text{C}$ | E_{off} | 2400 2800 | | | mJ mJ |
| Kurzschlußverhalten SC data | $V_{GE} \leq 15\text{ V}$, $V_{CC} = 4500\text{ V}$ $V_{CEmax} = V_{CES} - L_{SCE} \cdot di/dt$ $t_p \leq 10\ \mu\text{s}$, $T_{vj} = 125^{\circ}\text{C}$ | | I_{SC} | 3000 | | | A |
| Wärmewiderstand, Chip bis Gehäuse Thermal resistance, junction to case | pro IGBT / per IGBT | | R_{thJC} | | | 13,1 | K/kW |
| Wärmewiderstand, Gehäuse bis Kühlkörper Thermal resistance, case to heatsink | pro IGBT / per IGBT $\lambda_{Paste} = 1\text{ W}/(\text{m}\cdot\text{K})$ / $\lambda_{grease} = 1\text{ W}/(\text{m}\cdot\text{K})$ | | R_{thCH} | | | 13,0 | K/kW |
| Temperatur im Schaltbetrieb Temperature under switching conditions | | | $T_{vj\text{op}}$ | -50 | | 125 | $^{\circ}\text{C}$ |

Diode, Brems-Chopper / Diode, Brake-Chopper Höchstzulässige Werte / Maximum Rated Values

| | | | | |
|---|---|----------------------|----------------------|-----------------------|
| Periodische Spitzensperrspannung Repetitive peak reverse voltage | $T_{vj} = 125^{\circ}\text{C}$ $T_{vj} = 25^{\circ}\text{C}$ $T_{vj} = -50^{\circ}\text{C}$ | V_{RRM} | 6500 6500 5900 | V |
| Dauergleichstrom Continuous DC forward current | | I_F | 500 | A |
| Periodischer Spitzenstrom Repetitive peak forward current | $t_p = 1 \text{ ms}$ | I_{FRM} | 1000 | A |
| Grenzlastintegral I^2t - value | $V_R = 0 \text{ V}, t_p = 10 \text{ ms}, T_{vj} = 125^{\circ}\text{C}$ | I^2t | 210 | kA^2s |
| Spitzenverlustleistung Maximum power dissipation | $T_{vj} = 125^{\circ}\text{C}$ | P_{RQM} | 2000 | kW |
| Mindesteinschaltdauer Minimum turn-on time | | $t_{on \text{ min}}$ | 10,0 | μs |

Charakteristische Werte / Characteristic Values

| | | min. | typ. | max. | | |
|---|---|---|---------------------|--------------|--------------|--------------------------------|
| Durchlassspannung Forward voltage | $I_F = 500 \text{ A}, V_{GE} = 0 \text{ V}$ $I_F = 500 \text{ A}, V_{GE} = 0 \text{ V}$ | $T_{vj} = 25^{\circ}\text{C}$ $T_{vj} = 125^{\circ}\text{C}$ | V_F | 3,00 2,95 | 3,50 3,50 | V V |
| Rückstromspitze Peak reverse recovery current | $I_F = 500 \text{ A}, -di_F/dt = 2000 \text{ A}/\mu\text{s} (T_{vj}=125^{\circ}\text{C})$ $V_R = 3600 \text{ V}$ $V_{GE} = -15 \text{ V}$ | $T_{vj} = 25^{\circ}\text{C}$ $T_{vj} = 125^{\circ}\text{C}$ | I_{RM} | 730 800 | | A A |
| Sperrverzögerungsladung Recovered charge | $I_F = 500 \text{ A}, -di_F/dt = 2000 \text{ A}/\mu\text{s} (T_{vj}=125^{\circ}\text{C})$ $V_R = 3600 \text{ V}$ $V_{GE} = -15 \text{ V}$ | $T_{vj} = 25^{\circ}\text{C}$ $T_{vj} = 125^{\circ}\text{C}$ | Q_r | 570 1050 | | μC μC |
| Abschaltenergie pro Puls Reverse recovery energy | $I_F = 500 \text{ A}, -di_F/dt = 2000 \text{ A}/\mu\text{s} (T_{vj}=125^{\circ}\text{C})$ $V_R = 3600 \text{ V}$ $V_{GE} = -15 \text{ V}$ | $T_{vj} = 25^{\circ}\text{C}$ $T_{vj} = 125^{\circ}\text{C}$ | E_{rec} | 930 2000 | | mJ mJ |
| Wärmewiderstand, Chip bis Gehäuse Thermal resistance, junction to case | pro Diode / per diode | | R_{thJC} | | 28,0 | K/kW |
| Wärmewiderstand, Gehäuse bis Kühlkörper Thermal resistance, case to heatsink | pro Diode / per diode $\lambda_{\text{Paste}} = 1 \text{ W}/(\text{m}\cdot\text{K})$ / $\lambda_{\text{grease}} = 1 \text{ W}/(\text{m}\cdot\text{K})$ | | R_{thCH} | | 21,0 | K/kW |
| Temperatur im Schaltbetrieb Temperature under switching conditions | | | $T_{vj \text{ op}}$ | -50 | 125 | $^{\circ}\text{C}$ |

Diode, Revers / Diode, Reverse

Höchstzulässige Werte / Maximum Rated Values

| | | | | |
|---|---|----------------------|----------------------|-----------------------|
| Periodische Spitzensperrspannung Repetitive peak reverse voltage | $T_{vj} = 125^{\circ}\text{C}$ $T_{vj} = 25^{\circ}\text{C}$ $T_{vj} = -50^{\circ}\text{C}$ | V_{RRM} | 6500 6500 5900 | V |
| Dauergleichstrom Continuous DC forward current | | I_F | 500 | A |
| Periodischer Spitzenstrom Repetitive peak forward current | $t_P = 1 \text{ ms}$ | I_{FRM} | 1000 | A |
| Grenzlastintegral I^2t - value | $V_R = 0 \text{ V}, t_P = 10 \text{ ms}, T_{vj} = 125^{\circ}\text{C}$ | I^2t | 210 | kA^2s |
| Spitzenverlustleistung Maximum power dissipation | $T_{vj} = 125^{\circ}\text{C}$ | P_{RQM} | 2000 | kW |
| Mindesteinschaltdauer Minimum turn-on time | | $t_{on \text{ min}}$ | 10,0 | μs |

Charakteristische Werte / Characteristic Values

| | | min. | typ. | max. | | |
|---|---|---|---------------------|--------------|--------------|--------------------------------|
| Durchlassspannung Forward voltage | $I_F = 500 \text{ A}, V_{GE} = 0 \text{ V}$ $I_F = 500 \text{ A}, V_{GE} = 0 \text{ V}$ | $T_{vj} = 25^{\circ}\text{C}$ $T_{vj} = 125^{\circ}\text{C}$ | V_F | 3,00 2,95 | 3,50 3,50 | V V |
| Rückstromspitze Peak reverse recovery current | $I_F = 500 \text{ A}, -di_F/dt = 2000 \text{ A}/\mu\text{s} (T_{vj}=125^{\circ}\text{C})$ $V_R = 3600 \text{ V}$ $V_{GE} = -15 \text{ V}$ | $T_{vj} = 25^{\circ}\text{C}$ $T_{vj} = 125^{\circ}\text{C}$ | I_{RM} | 730 800 | | A A |
| Sperrverzögerungsladung Recovered charge | $I_F = 500 \text{ A}, -di_F/dt = 2000 \text{ A}/\mu\text{s} (T_{vj}=125^{\circ}\text{C})$ $V_R = 3600 \text{ V}$ $V_{GE} = -15 \text{ V}$ | $T_{vj} = 25^{\circ}\text{C}$ $T_{vj} = 125^{\circ}\text{C}$ | Q_r | 570 1050 | | μC μC |
| Abschaltenergie pro Puls Reverse recovery energy | $I_F = 500 \text{ A}, -di_F/dt = 2000 \text{ A}/\mu\text{s} (T_{vj}=125^{\circ}\text{C})$ $V_R = 3600 \text{ V}$ $V_{GE} = -15 \text{ V}$ | $T_{vj} = 25^{\circ}\text{C}$ $T_{vj} = 125^{\circ}\text{C}$ | E_{rec} | 930 2000 | | mJ mJ |
| Wärmewiderstand, Chip bis Gehäuse Thermal resistance, junction to case | pro Diode / per diode | | R_{thJC} | | 28,0 | K/kW |
| Wärmewiderstand, Gehäuse bis Kühlkörper Thermal resistance, case to heatsink | pro Diode / per diode $\lambda_{\text{Paste}} = 1 \text{ W}/(\text{m}\cdot\text{K})$ / $\lambda_{\text{grease}} = 1 \text{ W}/(\text{m}\cdot\text{K})$ | | R_{thCH} | | 16,0 | K/kW |
| Temperatur im Schaltbetrieb Temperature under switching conditions | | | $T_{vj \text{ op}}$ | -50 | 125 | $^{\circ}\text{C}$ |

Modul / Module

| | | | | | |
|---|--|--|--------------|--------------|--------------|
| Isolations-Prüfspannung Isolation test voltage | RMS, f = 50 Hz, t = 10 s | V _{ISOL} | 10,4 | | kV |
| Teilentladungs-Aussetzspannung Partial discharge extinction voltage | RMS, f = 50 Hz, Q _{PD} typ 10 pC | V _{ISOL} | 5,10 | | kV |
| Kollektor-Emitter-Gleichsperrspannung DC stability | T _{vj} = 25°C, 100 fit | V _{CE D} | 3800 | | V |
| Material Modulgrundplatte Material of module baseplate | | | AlSiC | | |
| Innere Isolation Internal isolation | Basisisolierung (Schutzklasse 1, EN61140) basic insulation (class 1, IEC 61140) | | AlN | | |
| Kriechstrecke Creepage distance | Kontakt - Kühlkörper / terminal to heatsink Kontakt - Kontakt / terminal to terminal | | 56,0 56,0 | | mm |
| Luftstrecke Clearance | Kontakt - Kühlkörper / terminal to heatsink Kontakt - Kontakt / terminal to terminal | | 26,0 26,0 | | mm |
| Vergleichszahl der Kriechwegbildung Comperative tracking index | | CTI | > 600 | | |
| | | | min. | typ. | max. |
| Modulstreuinduktivität Stray inductance module | | L _{sCE} | | 20 | nH |
| Modulleitungswiderstand, Anschlüsse - Chip Module lead resistance, terminals - chip | T _C = 25°C, pro Schalter / per switch | R _{CC'+EE'} R _{AA'+CC'} | | 0,18 0,18 | mΩ |
| Lagertemperatur Storage temperature | | T _{stg} | -55 | | 125 °C |
| Anzugsdrehmoment f. Modulmontage Mounting torque for modul mounting | Schraube M6 - Montage gem. gültiger Applikationsschrift Screw M6 - Mounting according to valid application note | M | 4,25 | | 5,75 Nm |
| Anzugsdrehmoment f. elektr. Anschlüsse Terminal connection torque | Schraube M4 - Montage gem. gültiger Applikationsschrift Screw M4 - Mounting according to valid application note Schraube M8 - Montage gem. gültiger Applikationsschrift Screw M8 - Mounting according to valid application note | M | 1,8 8,0 | - - | 2,1 10 Nm |
| Gewicht Weight | | G | | 1400 | g |

Important Note: Measurements have shown that the device is technically capable of achieving a turn-on time of 1 μs or less as stipulated in item 3A228.c of Annex I of the Council Regulation (EC) No 428/2009 of 5 May 2009. However, Infineon strongly recommends to refrain from using the device under conditions leading to such a turn-on time. Such a use may affect the device's performance or even cause a severe detriment to the device. In case of any doubts, please contact MUC_Licenses@infineon.com.

Ausgangskennlinie IGBT, Brems-Chopper (typisch)
output characteristic IGBT, Brake-Chopper (typical)

$I_C = f(V_{CE})$
 $V_{GE} = 15\text{ V}$

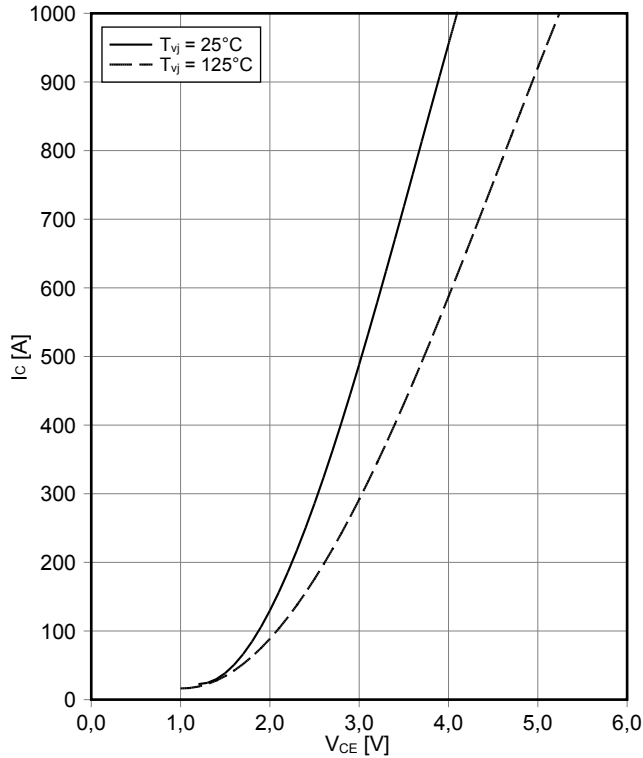

Ausgangskennlinienfeld IGBT, Brems-Chopper (typisch)
output characteristic IGBT, Brake-Chopper (typical)

$I_C = f(V_{CE})$
 $T_{vj} = 125^\circ\text{C}$

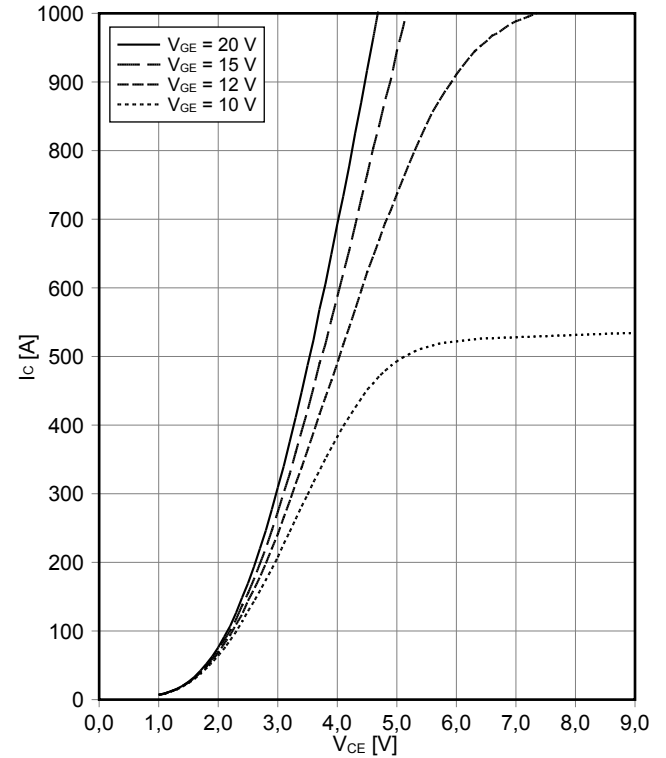

Übertragungscharakteristik IGBT, Brems-Chopper (typisch)
transfer characteristic IGBT, Brake-Chopper (typical)

$I_C = f(V_{GE})$
 $V_{CE} = 20\text{ V}$

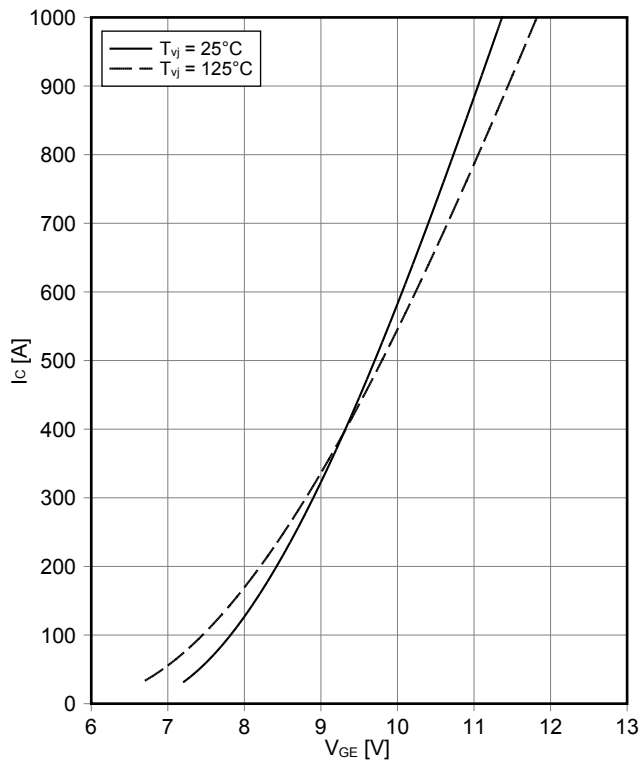

Schaltverluste IGBT, Brems-Chopper (typisch)
switching losses IGBT, Brake-Chopper (typical)

$E_{on} = f(I_C)$, $E_{off} = f(I_C)$
 $V_{GE} = \pm 15\text{ V}$, $R_{Gon} = 1.5\ \Omega$, $R_{Goff} = 10\ \Omega$, $V_{CE} = 3600\text{ V}$

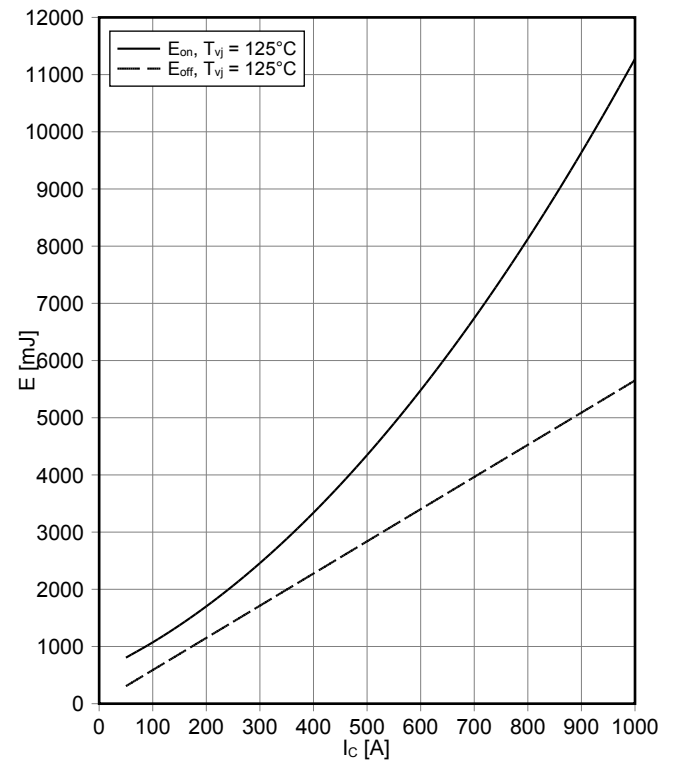

Schaltverluste IGBT, Brems-Chopper (typisch)
switching losses IGBT, Brake-Chopper (typical)

$E_{on} = f(R_G)$, $E_{off} = f(R_G)$
 $V_{GE} = \pm 15\text{ V}$, $I_C = 500\text{ A}$, $V_{CE} = 3600\text{ V}$

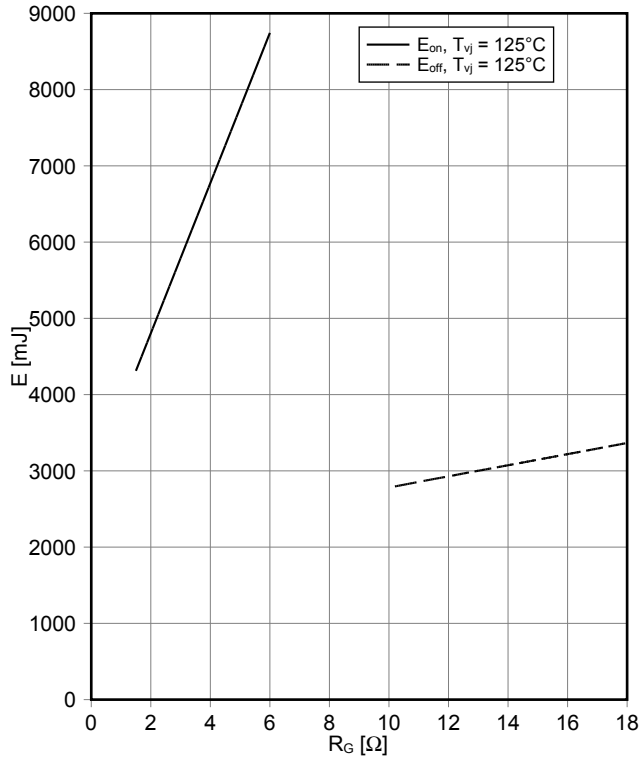

Transienter Wärmewiderstand IGBT, Brems-Chopper
transient thermal impedance IGBT, Brake-Chopper

$Z_{thJC} = f(t)$

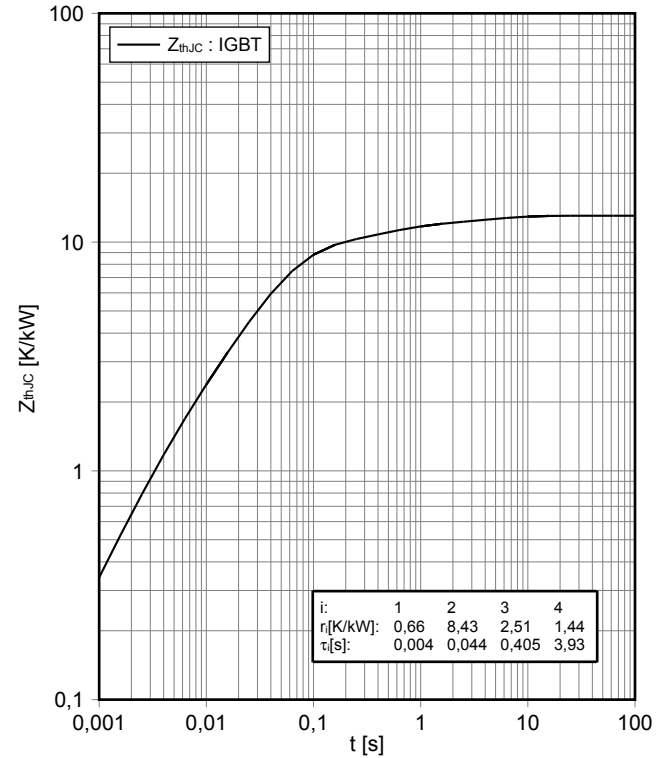

Sicherer Rückw.-Arbeitsber. IGBT, Brems-Chopper (RBSOA)
reverse bias safe operating area IGBT, Brake-Chopper (RBSOA)

$I_C = f(V_{CE})$
 $V_{GE} = \pm 15\text{ V}$, $R_{Goff} = 10\ \Omega$, $T_{vj} = 125^\circ\text{C}$

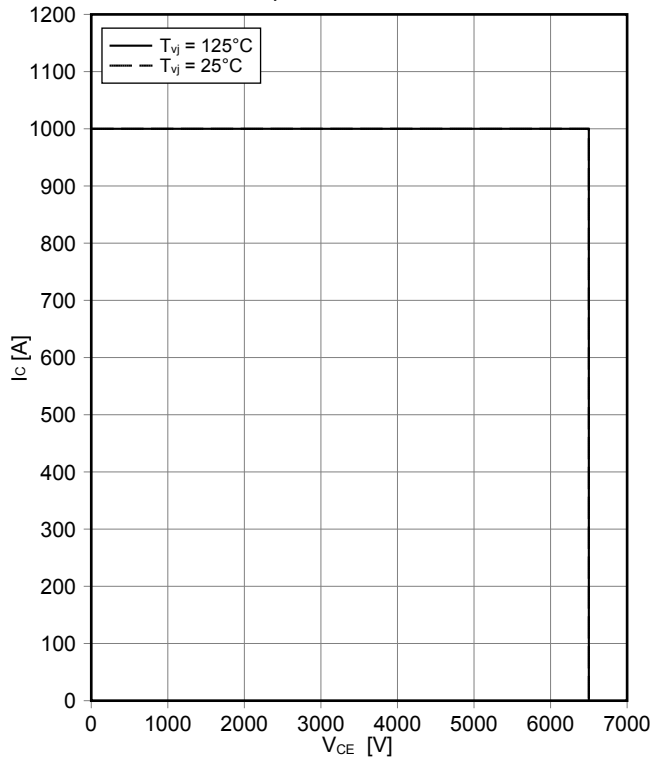

Durchlasskennlinie der Diode, Brems-Chopper (typisch)
forward characteristic of Diode, Brake-Chopper (typical)

$I_F = f(V_F)$

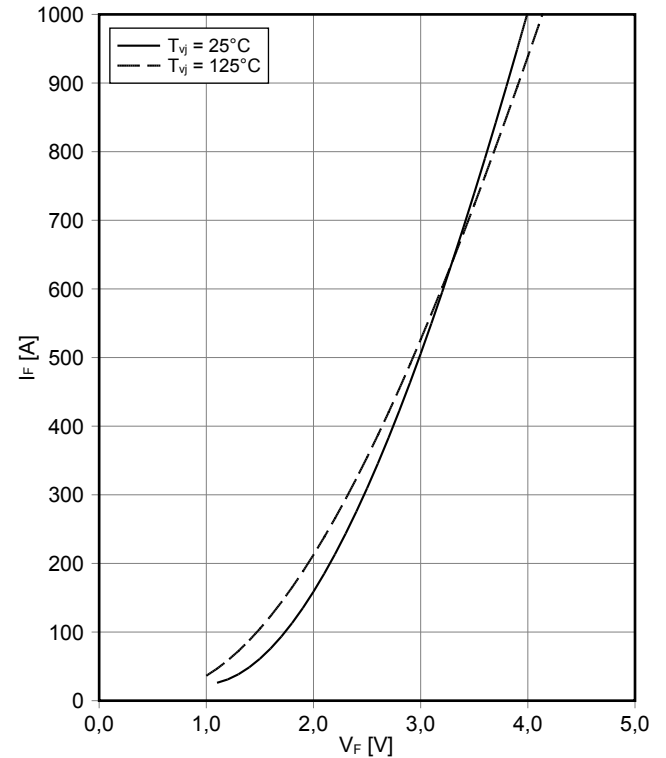

Schaltverluste Diode, Brems-Chopper (typisch)
switching losses Diode, Brake-Chopper (typical)

$E_{rec} = f(I_F)$
 $R_{Gon} = 1.5 \Omega, V_{CE} = 3600 V$

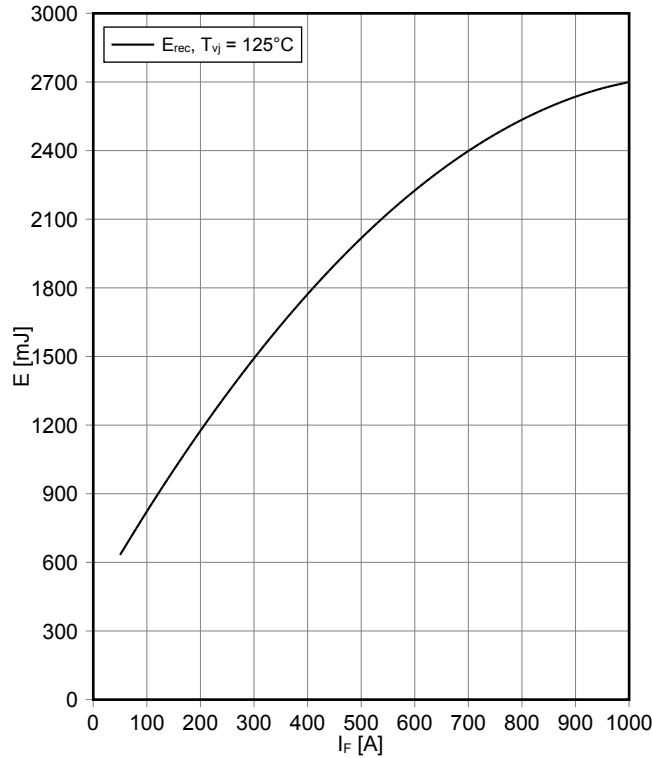

Schaltverluste Diode, Brems-Chopper (typisch)
switching losses Diode, Brake-Chopper (typical)

$E_{rec} = f(R_G)$
 $I_F = 500 A, V_{CE} = 3600 V$

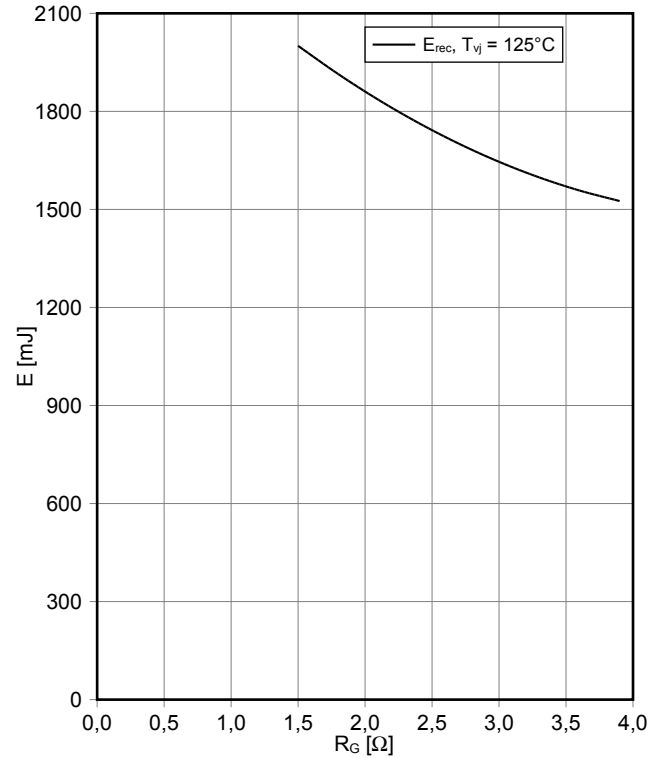

Transienter Wärmewiderstand Diode, Brems-Chopper
transient thermal impedance Diode, Brake-Chopper

$Z_{thJC} = f(t)$

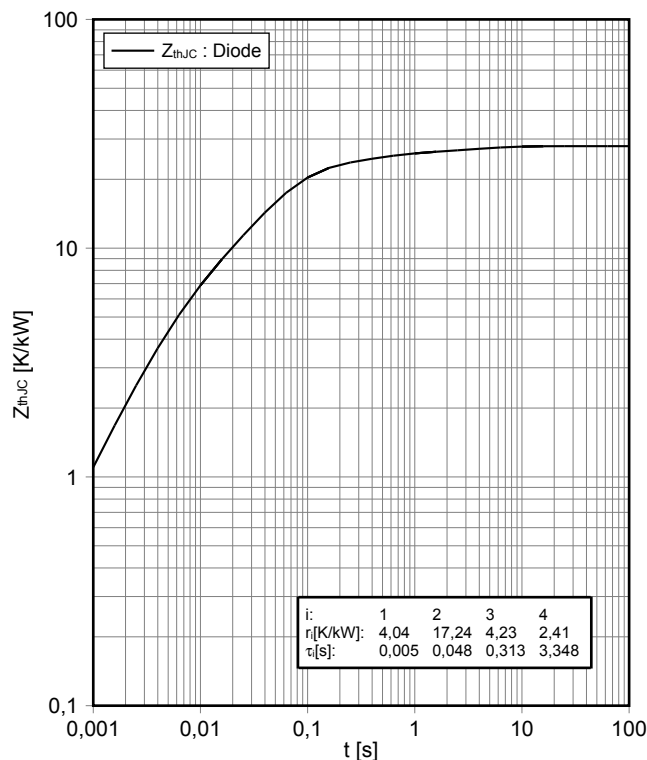

Sicherer Arbeitsbereich Diode, Brems-Chopper (SOA)
safe operation area Diode, Brake-Chopper (SOA)

$I_R = f(V_R)$
 $T_{vj} = 125^\circ C$

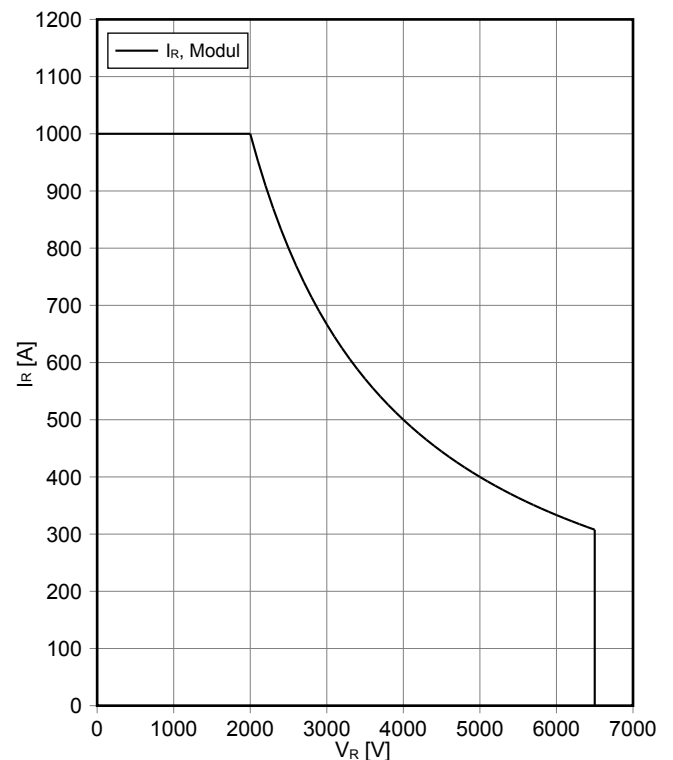

Durchlasskennlinie der Diode, Revers (typisch)
forward characteristic of Diode, Reverse (typical)
 $I_F = f(V_F)$

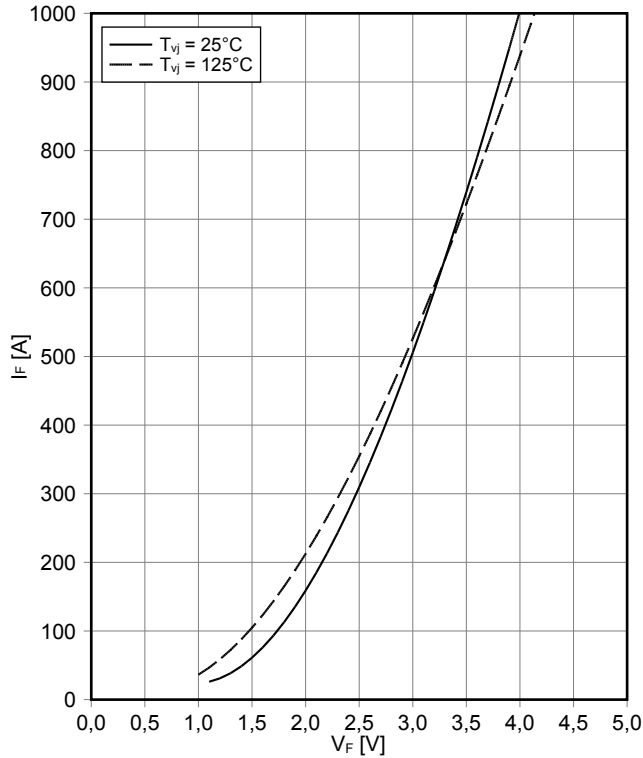

Schaltverluste Diode, Revers (typisch)
switching losses Diode, Reverse (typical)
 $E_{rec} = f(I_F)$
 $R_{Gon} = 1.5 \Omega, V_{CE} = 3600 V$

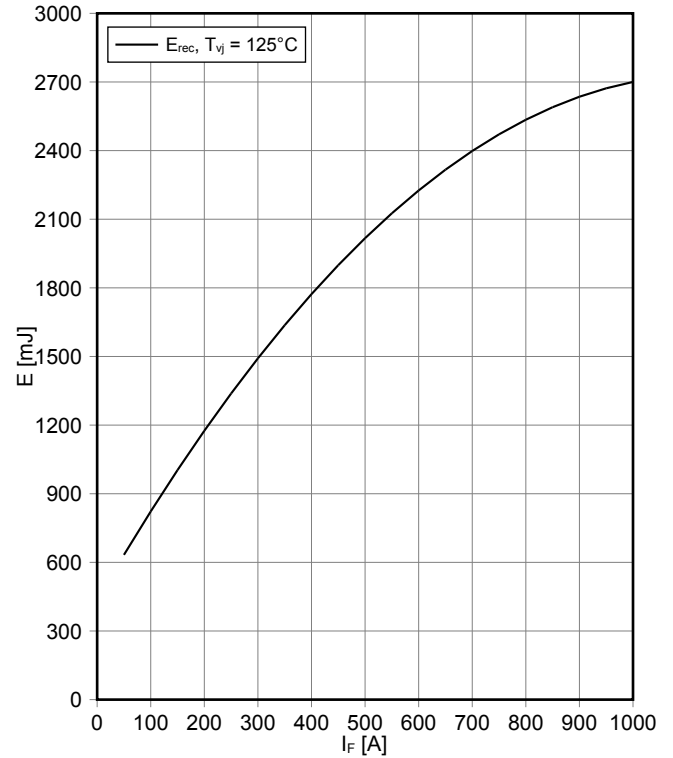

Schaltverluste Diode, Revers (typisch)
switching losses Diode, Reverse (typical)
 $E_{rec} = f(R_G)$
 $I_F = 500 A, V_{CE} = 3600 V$

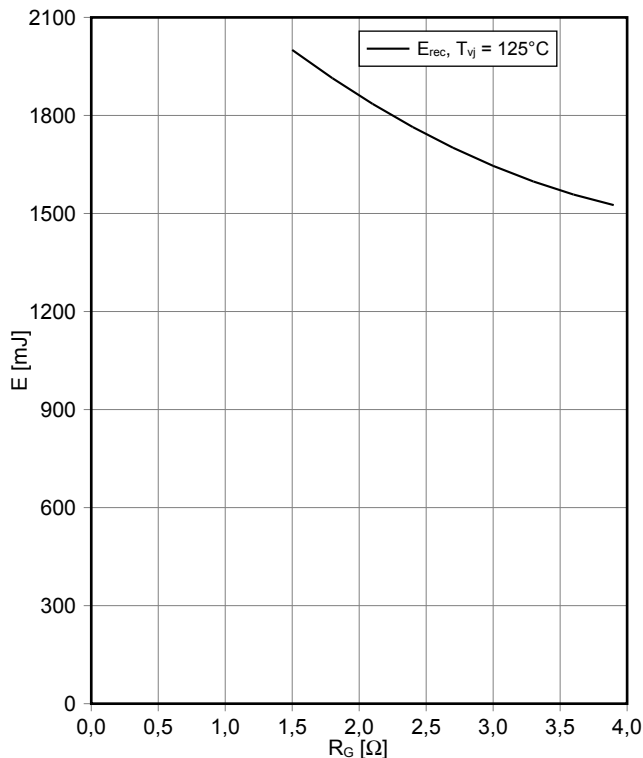

Transienter Wärmewiderstand Diode, Revers
transient thermal impedance Diode, Reverse
 $Z_{thJC} = f(t)$

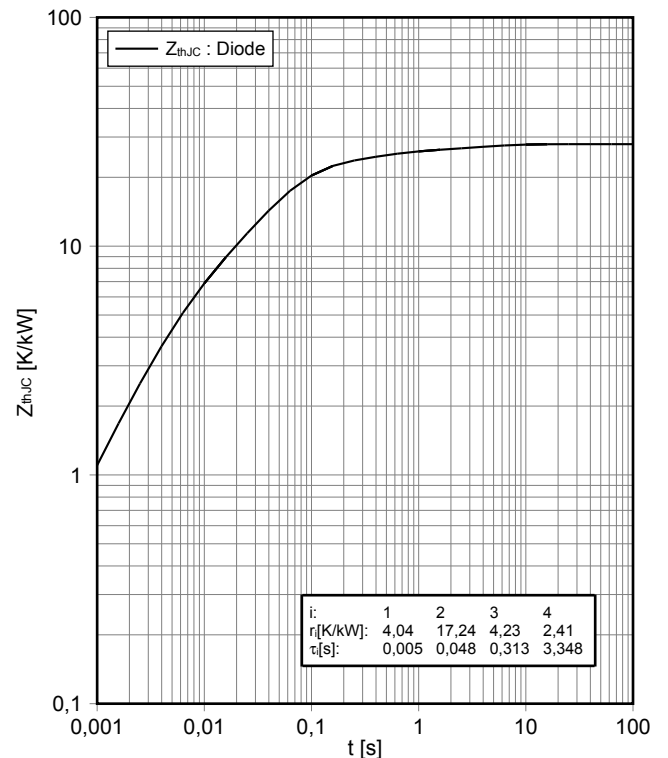

Sicherer Arbeitsbereich Diode, Revers (SOA)
safe operation area Diode, Reverse (SOA)

$I_R = f(V_R)$
 $T_{vj} = 125^\circ\text{C}$

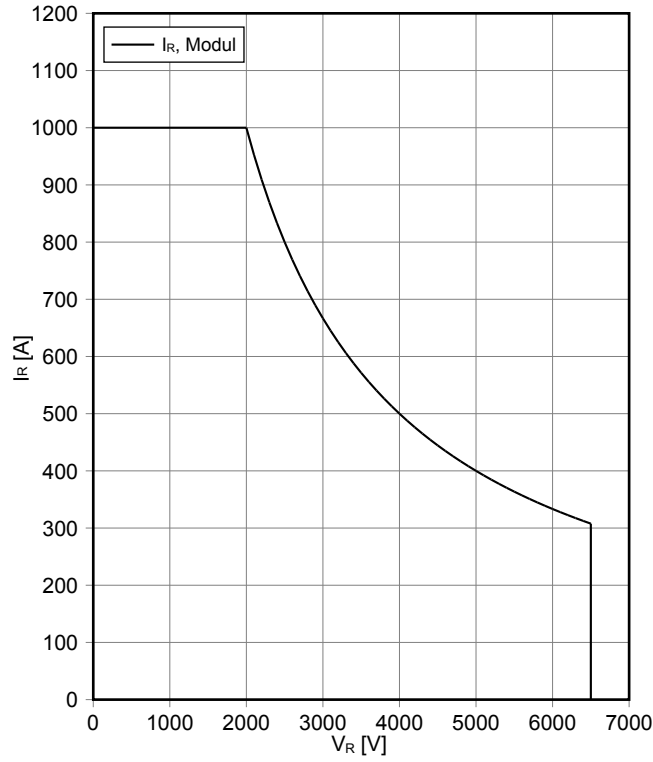

Schaltplan / Circuit diagram

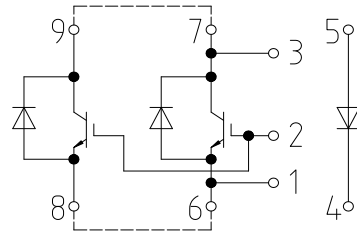

Gehäuseabmessungen / Package outlines

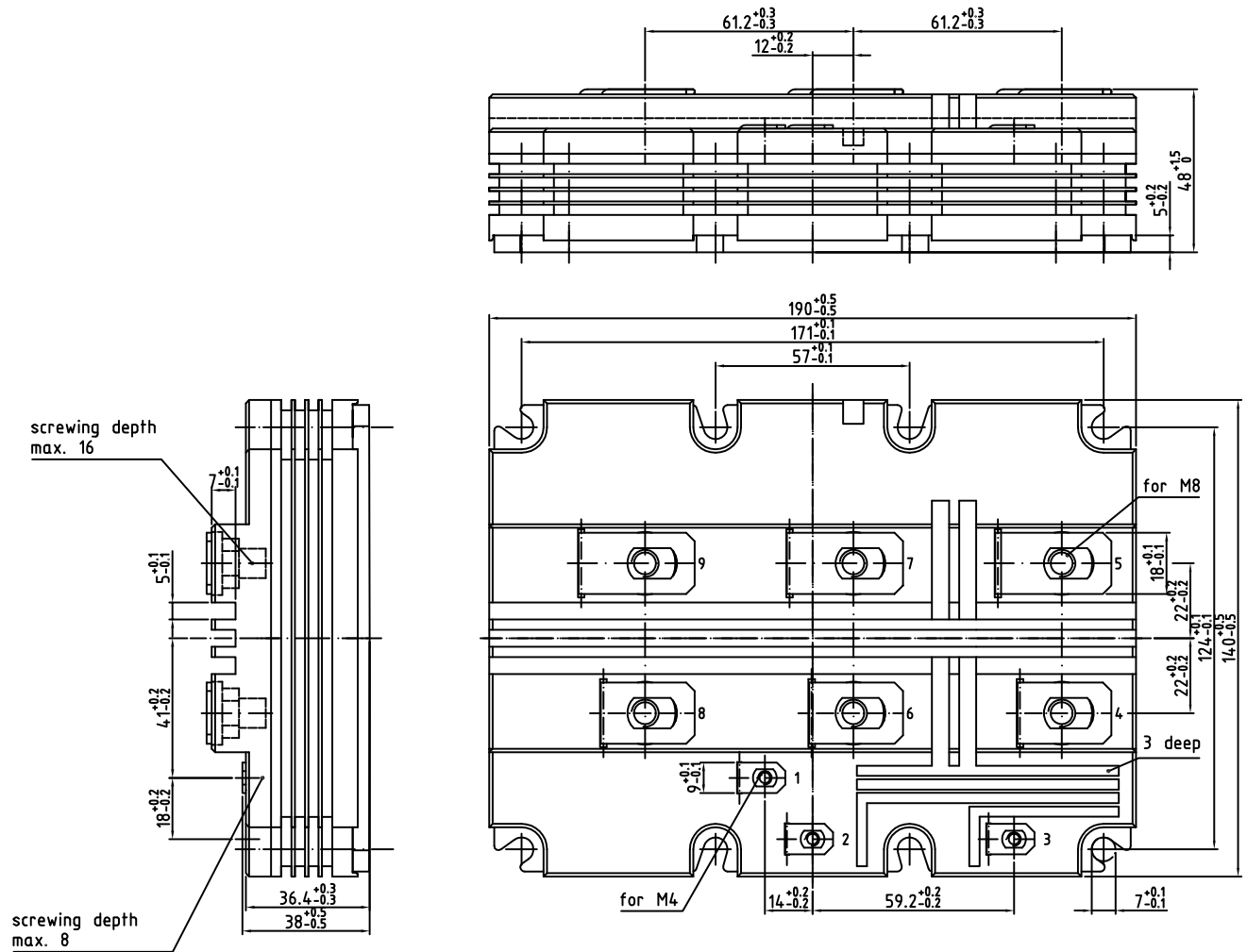

Trademarks

All referenced product or service names and trademarks are the property of their respective owners.

Edition 2019-09-06

Published by
Infineon Technologies AG
81726 München, Germany

© 2019 Infineon Technologies AG.
All Rights Reserved.

Do you have a question about this document?
Email: erratum@infineon.com

WICHTIGER HINWEIS

Die in diesem Dokument enthaltenen Angaben stellen keinesfalls Garantien für die Beschaffenheit oder Eigenschaften des Produktes ("Beschaffenhheitsgarantie") dar. Für Beispiele, Hinweise oder typische Werte, die in diesem Dokument enthalten sind, und/oder Angaben, die sich auf die Anwendung des Produktes beziehen, ist jegliche Gewährleistung und Haftung von Infineon Technologies ausgeschlossen, einschließlich, ohne hierauf beschränkt zu sein, die Gewähr dafür, dass kein geistiges Eigentum Dritter verletzt ist.

Des Weiteren stehen sämtliche, in diesem Dokument enthaltenen Informationen, unter dem Vorbehalt der Einhaltung der in diesem Dokument festgelegten Verpflichtungen des Kunden sowie aller im Hinblick auf das Produkt des Kunden sowie die Nutzung des Infineon Produktes in den Anwendungen des Kunden anwendbaren gesetzlichen Anforderungen, Normen und Standards durch den Kunden.

Die in diesem Dokument enthaltenen Daten sind ausschließlich für technisch geschultes Fachpersonal bestimmt. Die Beurteilung der Eignung dieses Produktes für die beabsichtigte Anwendung sowie die Beurteilung der Vollständigkeit der in diesem Dokument enthaltenen Produktdaten für diese Anwendung obliegt den technischen Fachabteilungen des Kunden.

Sollten Sie von uns weitere Informationen im Zusammenhang mit dem Produkt, der Technologie, Lieferbedingungen bzw. Preisen benötigen, wenden Sie sich bitte an das nächste Vertriebsbüro von Infineon Technologies (www.infineon.com).

WARNHINWEIS

Aufgrund der technischen Anforderungen können Produkte gesundheitsgefährdende Substanzen enthalten. Bei Fragen zu den in diesem Produkt enthaltenen Substanzen, setzen Sie sich bitte mit dem nächsten Vertriebsbüro von Infineon Technologies in Verbindung.

Sofern Infineon Technologies nicht ausdrücklich in einem schriftlichen, von vertretungsberechtigten Infineon Mitarbeitern unterzeichneten Dokument zugestimmt hat, dürfen Produkte von Infineon Technologies nicht in Anwendungen eingesetzt werden, in welchen vernünftigerweise erwartet werden kann, dass ein Fehler des Produktes oder die Folgen der Nutzung des Produktes zu Personenverletzungen führen.

IMPORTANT NOTICE

The information given in this document shall in no event be regarded as a guarantee of conditions or characteristics ("Beschaffenhheitsgarantie"). With respect to any examples, hints or any typical values stated herein and/or any information regarding the application of the product, Infineon Technologies hereby disclaims any and all warranties and liabilities of any kind, including without limitation warranties of non-infringement of intellectual property rights of any third party.

In addition, any information given in this document is subject to customer's compliance with its obligations stated in this document and any applicable legal requirements, norms and standards concerning customer's products and any use of the product of Infineon Technologies in customer's applications.

The data contained in this document is exclusively intended for technically trained staff. It is the responsibility of customer's technical departments to evaluate the suitability of the product for the intended application and the completeness of the product information given in this document with respect to such application.

For further information on the product, technology, delivery terms and conditions and prices please contact your nearest Infineon Technologies office (www.infineon.com).

WARNINGS

Due to technical requirements products may contain dangerous substances. For information on the types in question please contact your nearest Infineon Technologies office.

Except as otherwise explicitly approved by Infineon Technologies in a written document signed by authorized representatives of Infineon Technologies, Infineon Technologies' products may not be used in any applications where a failure of the product or any consequences of the use thereof can reasonably be expected to result in personal injury.

单击下面可查看定价，库存，交付和生命周期等信息

[>>Infineon Technologies\(英飞凌\)](#)